

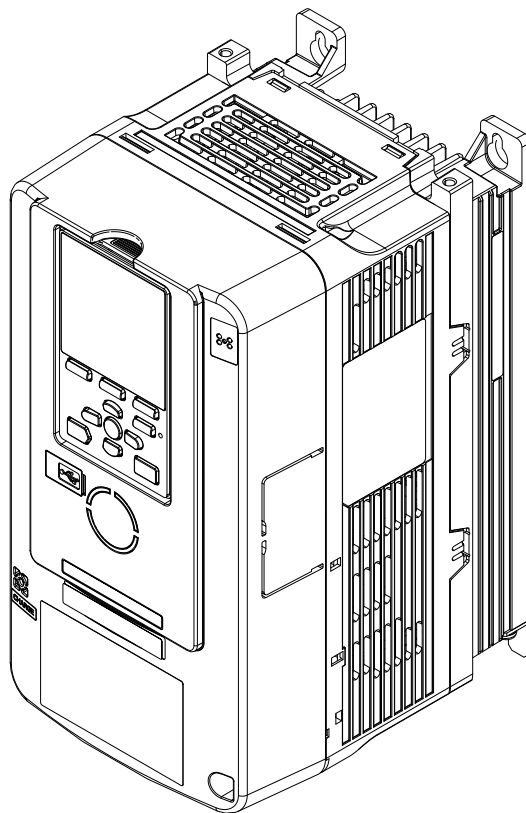
## YASKAWA AC Drive GA700

### High Performance Type

# Technical Manual

Type: CIPR-GA70Cxxxxxxx  
Models: 200 V class: 0.55 to 110 kW  
400 V class: 0.55 to 355 kW

To properly use the product, read this manual thoroughly and retain for easy reference, inspection, and maintenance. Ensure the end user receives this manual.



Receiving	1
Mechanical & Electrical Installation	2
Startup Procedure and Test Run	3
Standards Compliance	4
Network Communications	5
Troubleshooting	6
Periodic Inspection and Maintenance	7
Disposal	8
Specifications	9
Parameter List	10
Parameter Details	11

---

**This Page Intentionally Blank**

# Table of Contents

i.	Preface and General Precautions .....	13
i.1	Receiving .....	14
	Glossary .....	14
	About Registered Trademarks .....	14
i.2	Using the Product Safely .....	15
	Supplemental Safety Information .....	15
	General Safety .....	15
	Warning Label Content and Location .....	17
i.3	Warranty Information .....	18
	Warranty and Exclusion of Liability .....	18
1.	Receiving .....	19
1.1	Section Safety .....	20
1.2	Model Number and Nameplate Check .....	21
	Nameplate .....	21
	How to Read Model Numbers .....	21
1.3	Features and Advantages of Control Methods .....	26
2.	Mechanical & Electrical Installation .....	31
2.1	General Safety .....	32
2.2	Installation Environment .....	35
2.3	Installation Position and Distance .....	36
2.4	Moving the Drive .....	38
	Using the Hanging Brackets to Move the Drive .....	38
	Instructions on Drive Suspension .....	38
2.5	Drive Watt Loss .....	40
2.6	Remove and Reattach the Keypad .....	44
	Remove the Keypad .....	44
	Reattach the Keypad .....	44
2.7	Install the Keypad to a Control Panel or Another Device .....	45
	Operate the Keypad Apart from the Drive .....	45
	Connect the Keypad from a Remote Location .....	45
2.8	Removing/Reattaching Covers .....	50
	Removing/Reattaching the Cover Using Procedure A .....	50
	Removing/Reattaching the Cover Using Procedure B .....	51
2.9	Change the Drive Enclosure Type .....	55
	Attach the Protective Cover (Procedure A) .....	55
	Attach the Protective Cover (Procedure B) .....	56
	Attach the Protective Cover (Procedure C) .....	58
	Attach the Protective Cover (Procedure D) .....	61
	Attach the Protective Cover (Procedure E) .....	63
	Attach the Protective Cover (Procedure F) .....	65

2.10	Installation Methods	68
2.11	Electrical Installation	73
	Standard Connection Diagram	73
2.12	Main Circuit Wiring	76
	Motor and Main Circuit Connections	76
	Configuration of Main Circuit Terminal Block	76
	Main Circuit Terminal Functions	81
	Wire Selection	82
	Main Circuit Terminal and Motor Wiring	94
	Protection of Main Circuit Terminals	97
2.13	Main Circuit Terminal Block Wiring Procedure	98
	Wiring the Main Circuit Terminal Block Using Procedure A	98
	Wiring the Main Circuit Terminal Block Using Procedure B	101
2.14	Control Circuit Wiring	104
	Control Circuit Connection Diagram	104
	Control Circuit Terminal Block Functions	105
	Control Circuit Terminal Configuration	108
	Wiring the Control Circuit Terminal	110
	Switches and Jumpers on the Terminal Board	112
2.15	Control I/O Connections	113
	Pulse Train Output	113
	Set Sinking Mode/Sourcing Mode	114
	Set Input Signals for MFAI Terminals A1 to A3	114
	Set MFAI Terminal A3 to PTC Input	115
	Set Output Signals for MFAO Terminals FM, AM	115
	Switch ON Termination Resistor for MEMOBUS/Modbus Communications	116
2.16	Connect the Drive to a PC	117
2.17	External Interlock	118
2.18	Braking Resistor Installation	119
	Install a Braking Resistor: ERF-Type	119
	Install a Braking Resistor Unit: LKEB-Type	119
	Install a Braking Unit Connection: CDBR-Type	120
	Connect Braking Units in Parallel	120
	Dynamic Braking Option Overload Protection	121
2.19	Drive Wiring Protection	122
	Install a Molded-Case Circuit Breaker (MCCB) or Residual Current Monitor/Device (RCM/RCD)	122
	Install a Residual Current Monitoring/Detection (RCM/RCD)	122
2.20	Dynamic Braking Option, Motor Protection	123
	Install an Electromagnetic Contactor (MC) at the Input Side of the Drive	123
	Install a Thermal Overload Relay on the Drive Output	123
2.21	Improve the Power Factor	125
	Connect an AC Reactor or a DC Reactor	125
2.22	Prevent Switching Surge	126
2.23	Decrease Noise	127
	Connect a Noise Filter to the Input Side (Primary Side)	127
	Connect a Noise Filter to the Output Side (Secondary Side)	127
2.24	Protect the Drive during Failures	129
	Factory-Recommended Branch Circuit Protection	129
2.25	Wiring Checklist	133
2.26	Motor Application Precautions	135
	Precautions for Existing Standard Motors	135
	Precautions for PM Motors	136
	Precautions for Specialized Motors	136

	Notes on the Power Transmission Mechanism .....	137
<b>3.</b>	<b>Startup Procedure and Test Run .....</b>	<b>139</b>
3.1	Safety Precautions .....	140
3.2	Component Names and Functions .....	141
	LCD Display .....	143
	Indicator LEDs and Drive Status .....	144
	Keypad Mode and Menu Displays .....	145
3.3	LED Status Ring .....	147
3.4	Start-up Procedures .....	149
	Flowchart A: Connect and Run the Motor with Minimum Setting Changes .....	149
	Sub-Chart A-1: Induction Motor Auto-Tuning and Test Run Procedure .....	150
	Sub-Chart A-2: PM Motor Auto-Tuning and Test Run Procedure .....	150
	Subchart A-3: EZ Open Loop Vector Control Test Run Procedure .....	152
3.5	Items to Check before Starting Up the Drive .....	153
	Check before Energizing the Drive .....	153
	Check after Energizing the Drive .....	153
	Make the Initial Settings .....	154
3.6	Keypad Operation .....	155
	Use the HOME Screen .....	155
	Show the Standard Monitor .....	156
	Set Custom Monitors .....	157
	Show Custom Monitors .....	157
	Set the Monitors to Show as a Bar Graph .....	158
	Show Monitors as Bar Graphs .....	159
	Set the Monitors to Show as Analog Gauges .....	160
	Display Monitors as an Analog Gauge .....	161
	Set Monitoring Items to be Shown as a Trend Plot .....	162
	Show Monitor Items as a Trend Plot .....	165
	Change Parameter Settings .....	166
	Examine User Custom Parameters .....	168
	Save a Backup of Parameters .....	169
	Write Backed-up Parameters to the Drive .....	170
	Verify Keypad Parameters and Drive Parameters .....	171
	Delete Parameters Backed Up to the Keypad .....	172
	Check Modified Parameters .....	173
	Restore Modified Parameters to Defaults .....	174
	Show Fault History .....	176
	Auto-Tuning the Drive .....	176
	Set the Keypad Language Display .....	179
	Set the Date and Time .....	179
	Set Parameters Using the Setup Wizard .....	181
	Disable the Initial Setup Screen .....	183
	Start Data Logging .....	183
	Set Data to Log .....	184
	Set Backlight to Automatically Turn OFF .....	186
	Show Information about the Drive .....	188
	Write Automatically Backed-up Parameters to the Drive .....	189
3.7	Automatic Parameter Settings Optimized for Specific Applications (Application Presets) .....	190
3.8	Auto-Tuning .....	192
	Auto-Tuning for Induction Motors .....	192
	Auto-Tuning for PM Motors .....	193
	EZ Tuning .....	196
	Control Tuning .....	197
	Precautions before Auto-Tuning .....	199
3.9	Test Run .....	202

	No-Load Test Run	202
	Do a No-Load Test Run	202
	Actual-Load Test Run	202
	Do an Actual-Load Test Run	203
3.10	Fine Tuning during Test Runs (Adjust the Control Function)	204
	V/f Control and Closed Loop V/f Control	204
	Open Loop Vector Control Method	205
	Closed Loop Vector Control Method	208
	Advanced Open Loop Vector Control Method	209
	Fine-Tuning Open Loop Vector Control for PM Motors	211
	Advanced Open Loop Vector Control Method for PM	212
	Closed Loop Vector Control Method for PM	213
	EZ Open Loop Vector Control Method	214
3.11	Test Run Checklist	215
<b>4.</b>	<b>Standards Compliance</b>	<b>219</b>
4.1	General Safety	220
4.2	European Standards	222
	EU Declaration of Conformity	223
	CE Low Voltage Directive Compliance	228
	EMC Directive	245
4.3	UL Standards	256
	Area of Use	256
	Wire the Main Circuit Terminal Block	256
	Low Voltage Wiring for Control Circuit Terminals	276
	Drive Motor Overload and Overheat Protection	276
4.4	China RoHS Compliance	282
	Information on Hazardous Substances in This Product	282
4.5	对应中国RoHS指令	283
	本产品中含有有害物质的信息	283
4.6	Safe Disable Input	284
	Safe Disable Specifications	284
	Notes	285
	Using the Safe Disable Function	285
<b>5.</b>	<b>Network Communications</b>	<b>289</b>
5.1	Safety Precautions	290
5.2	Field Bus Network Support	291
5.3	MEMOBUS/Modbus Communications	292
	Configure Master/Slave	292
	Communication Specifications	292
	Communication with the PLC	292
	MEMOBUS/Modbus Drive Operations	294
	Communications Timing	294
	Message Format	295
	Examples of Messages for Commands/Responses	297
	Enter Command	302
	Self-Diagnostics	303
	Communications Data Table	303
	Error Codes	325
<b>6.</b>	<b>Troubleshooting</b>	<b>327</b>
6.1	General Safety	328
6.2	Types of Faults, Minor Faults, Alarms, and Errors	330
6.3	List of Fault, Minor Fault, Alarm, and Error Codes	331

6.4	Faults .....	337
6.5	Minor Faults/Alarms .....	361
6.6	Parameter Setting Errors .....	374
6.7	Auto-Tuning Errors .....	381
6.8	Backup Function Operating Mode Display and Errors .....	386
6.9	Diagnosing and Resetting Faults .....	388
	Fault and Power Loss Occur at the Same Time .....	388
	Fault Occurs Without Power Loss .....	388
	Fault Reset .....	388
6.10	Troubleshooting Without Fault Display .....	389
	The Parameter Settings Will Not Change .....	389
	The Motor Does Not Rotate After Entering Run Command .....	389
	The Motor Rotates in the Opposite Direction from the Run Command .....	390
	The Motor Rotates in Only One Direction .....	391
	The Motor Is Too Hot .....	391
	The Correct Auto-Tuning Mode Is Not Available .....	391
	The Motor Stalls during Acceleration or Accel/Decel Time Is Too Long .....	392
	The Drive Frequency Reference Is Different than the Controller Frequency Reference Command .....	393
	The Motor Speed Is Not Stable When Using a PM Motor .....	393
	There Is Too Much Motor Oscillation and the Rotation Is Irregular .....	393
	Deceleration Takes Longer Than Expected When Dynamic Braking Is Enabled .....	394
	The Load Falls When a Brake Is Applied .....	394
	There Is Audible Noise from the Drive or Motor Cables When the Drive Is Energized .....	394
	Residual Current Monitoring/Detection (RCM/RCD) Trips During Run .....	395
	Motor Rotation Causes Unexpected Audible Noise from Connected Machinery .....	395
	Motor Rotation Causes Oscillation or Hunting .....	395
	PID Output Fault .....	395
	The Starting Torque Is Not Sufficient .....	396
	The Motor Rotates after the Drive Output Is Shut Off .....	396
	The Output Frequency Is Lower Than the Frequency Reference .....	396
	The Motor Is Making an Audible Noise .....	396
	The Motor Will Not Restart after a Loss of Power .....	396
7.	Periodic Inspection and Maintenance .....	397
7.1	Section Safety .....	398
7.2	Inspection .....	400
	Recommended Daily Inspection .....	400
	Recommended Periodic Inspection .....	400
7.3	Maintenance .....	403
7.4	Replace a Cooling Fan and Circulation Fan .....	405
	Cooling Fans and Circulation Fans by Drive Model .....	405
	Replace a Fan (Procedure A) .....	405
	Replace a Fan (Procedure B) .....	407
	Replace a Fan (Procedure C) .....	410
	Replace a Fan (Procedure D) .....	412
	Replace a Fan (Procedure E) .....	414
	Replace Fans (Procedure F) .....	417
	Replace Fans (Procedure G) .....	423
7.5	Replace the Drive .....	431
	About the Control Circuit Terminal Block .....	431
	Replace the Drive .....	431
7.6	Replace the Keypad Battery .....	437
7.7	Storage Guidelines .....	438

8.	Disposal	439
8.1	Section Safety	440
8.2	Disposal Instructions	441
9.	Specifications	443
9.1	Safety Precautions	444
9.2	Drive Duty Modes	445
9.3	Model Specifications (200 V Class)	446
9.4	Model Specifications (400 V Class)	449
9.5	Drive Specifications	456
9.6	Drive Derating	460
	Carrier Frequency Settings and Rated Current Values	460
	Altitude Derating	464
9.7	Drive Exterior and Mounting Dimensions	465
	Drive Models and Exterior/Mounting Dimensions	465
	Open Chassis Type (IP20)	466
	Enclosed Wall-mounted Type (UL Type 1)	476
9.8	Knock-Out Hole Dimensions (UL Type 1)	485
	Models and Dimensions of Knock-Out Hole	485
9.9	Peripheral Devices and Options	490
10.	Parameter List	495
10.1	Section Safety	496
10.2	How to Read the Parameter List	497
	Icons and Terms that Identify Parameters and Control Modes	497
10.3	Parameter Groups	498
10.4	A: Initialization Parameters	500
	A1: Initialization	500
	A2: User Parameters	501
10.5	b: Application	502
	b1: Operation Mode Selection	502
	b2: DC Injection Braking and Short Circuit Braking	503
	b3: Speed Search	504
	b4: Timer Function	506
	b5: PID Control	507
	b6: Dwell Function	510
	b7: Droop Control	511
	b8: Energy Saving	511
	b9: Zero Servo	512
10.6	C: Tuning	513
	C1: Accel & Decel Time	513
	C2: S-Curve Characteristics	514
	C3: Slip Compensation	514
	C4: Torque Compensation	515
	C5: Automatic Speed Regulator (Automatic Speed Regulator)	516
	C6: Duty & Carrier Frequency	518
10.7	d: Reference Settings	519
	d1: Frequency Reference	519
	d2: Reference Limits	521
	d3: Jump Frequency	521
	d4: Frequency Reference Hold and Up/Down 2 Function	522
	d5: Torque Control	523
	d6: Field Weakening and Field Forcing	523
	d7: Offset Frequency	524



10.8	E: Motor Parameters	525
	E1: V/f Pattern for Motor 1	525
	E2: Motor Parameters	526
	E3: V/f Pattern for Motor 2	527
	E4: Motor 2 Parameters	528
	E5: PM Motor Settings	529
	E9: Motor Setting	530
10.9	F: Options	531
	F1: PG Option Setup (Encoder)	531
	F2: Analog Input Option	533
	F3: Digital Input Option	534
	F4: Analog Monitor Option	535
	F5: Digital Output Option	536
	F6: Communication Options	536
	F7: Ethernet Options	541
10.10	H: Terminal Functions	546
	H1: Digital Inputs	546
	H2: Digital Outputs	552
	H3: Analog Inputs	560
	H4: Analog Outputs	563
	H5: Modbus Communication	564
	H6: Pulse Train Input/Output	566
	H7: Virtual Inputs/Outputs	566
10.11	L: Protection Functions	568
	L1: Motor Protection	568
	L2: Power Loss Ride Through	569
	L3: Stall Prevention	570
	L4: Speed Detection	572
	L5: Fault Restart	573
	L6: Torque Detection	573
	L7: Torque Limit	574
	L8: Hardware Protection	575
	L9: Drive Protection 2	578
10.12	n: Special Adjustment	579
	n1: Hunting Prevention	579
	n2: SpdFeedbackDetectControl(AFR)Tun	580
	n3: High Slip Braking (HSB)	580
	n4: Observer	581
	n5: Feed Forward Control	582
	n6: Online Tuning	582
	n7: EZ Drive	582
	n8: PM Motor Control Tuning	583
10.13	o: Keypad-Related Settings	586
	o1: Keypad Display	586
	o2: Keypad Operation	588
	o3: Copy Function	589
	o4: Maintenance Monitors	590
	o5: Log Function	591
10.14	q: DriveWorksEZ Parameters	593
	q1-01 to q8-40: Reserved for DriveWorksEZ	593
10.15	r: DWEZ Connection 1-20	594
	r1-01 to r1-40: DriveWorksEZ Connection Parameters 1 to 20 (Upper / Lower)	594
10.16	T: Motor Tuning	595
	T0: Tuning Mode Selection	595
	T1: InductionMotor Auto-Tuning	595
	T2: PM Motor Auto-Tuning	596
	T3: ASR and Inertia Tuning	597

T4: EZ Tuning . . . . .	598
10.17 U: Monitors . . . . .	599
U1: Operation Status Monitors . . . . .	599
U2: Fault Trace . . . . .	601
U3: Fault History . . . . .	604
U4: Maintenance Monitors . . . . .	605
U5: PID Monitors . . . . .	609
U6: Operation Status Monitors . . . . .	610
U8: DriveWorksEZ Monitors . . . . .	613
10.18 Parameters that Change from the Default Settings with A1-02 [Control Method Selection] . . . . .	614
10.19 E3-01 [Motor 2 Control Mode] Dependent Parameters . . . . .	620
10.20 Parameters Changed by E1-03 [V/f Pattern Selection] . . . . .	621
10.21 Defaults by Drive Model and Duty Rating ND/HD . . . . .	623
200 V class . . . . .	623
400 V Class . . . . .	633
10.22 Parameters Changed by PM Motor Code Selection . . . . .	647
Yaskawa SMRA Series SPM Motors . . . . .	647
Yaskawa SSR1 Series IPM Motors (Derated Torque) . . . . .	648
Yaskawa SST4 Series IPM Motors (Constant Torque) . . . . .	660
<b>11. Parameter Details . . . . .</b>	<b>673</b>
11.1 Safety Precautions . . . . .	674
11.2 A: Initialization Parameters . . . . .	675
A1: Initialization . . . . .	675
A2: User Parameters . . . . .	696
11.3 b: Application . . . . .	697
b1: Operation Mode Selection . . . . .	697
b2: DC Injection Braking and Short Circuit Braking . . . . .	710
b3: Speed Search . . . . .	713
b4: Timer Function . . . . .	721
b5: PID Control . . . . .	723
b6: Dwell Function . . . . .	740
b7: Droop Control . . . . .	741
b8: Energy Saving . . . . .	742
b9: Zero Servo . . . . .	747
11.4 C: Tuning . . . . .	749
C1: Accel & Decel Time . . . . .	749
C2: S-Curve Characteristics . . . . .	754
C3: Slip Compensation . . . . .	755
C4: Torque Compensation . . . . .	759
C5: Auto Speed Regulator (ASR) . . . . .	762
C6: Duty & Carrier Frequency . . . . .	771
11.5 d: References . . . . .	775
d1: Frequency Reference . . . . .	775
d2: Reference Limits . . . . .	781
d3: Jump Frequency . . . . .	782
d4: Frequency Ref Up/Down & Hold . . . . .	784
d5: Torque Control . . . . .	790
d6: Field Weakening /Forcing . . . . .	795
d7: Offset Frequency . . . . .	796
11.6 E: Motor Parameters . . . . .	798
E1: V/f Pattern for Motor 1 . . . . .	798
E2: Motor Parameters . . . . .	806
E3: V/f Pattern for Motor 2 . . . . .	809
E4: Motor 2 Parameters . . . . .	811

	E5: PM Motor Settings . . . . .	814
	E9: Motor Setting . . . . .	817
11.7	F: Options . . . . .	820
	F1: Encoder Option Setup . . . . .	820
	F2: Analog Input Option . . . . .	827
	F3: Digital Input Option . . . . .	829
	F4: Analog Monitor Option . . . . .	834
	F5: Digital Output Option . . . . .	836
	F6, F7: Communication Options . . . . .	839
11.8	H: Terminal Functions . . . . .	862
	H1: Digital Inputs . . . . .	862
	Multi-Function Digital Input Setting Values . . . . .	866
	H2: Multi-function Digital Output . . . . .	886
	H2 MFDO Parameters . . . . .	889
	MFDO Setting Value . . . . .	896
	H3: Analog Inputs . . . . .	911
	H3: MFAI Parameters . . . . .	913
	Multi-Function Analog Input Terminal Settings . . . . .	918
	H4: Analog Outputs . . . . .	924
	H5: Memobus/Modbus Communication . . . . .	927
	H6: Pulse Train Input/Output . . . . .	931
	H7: Virtual Multi-Function I/O . . . . .	934
11.9	L: Protection Functions . . . . .	939
	L1: Motor Protection . . . . .	939
	L2: Power Loss Ride Through . . . . .	945
	L3: Stall Prevention . . . . .	955
	L4: Speed Detection . . . . .	965
	L5: Fault Restart . . . . .	967
	L6: Torque Detection . . . . .	969
	L7: Torque Limit . . . . .	974
	L8: Drive Protection . . . . .	977
	L9: Drive Protection 2 . . . . .	986
11.10	n: Special Adjustment . . . . .	987
	n1: Hunting Prevention . . . . .	987
	n2: Auto Freq Regulator (AFR) . . . . .	989
	n3: High Slip Braking (HSB) and Overexcitation Braking . . . . .	990
	n4: Adv Open Loop Vector Tune . . . . .	993
	n5: Feed Forward Control . . . . .	997
	n6: Online Tuning . . . . .	999
	n7: EZ Drive . . . . .	1000
	n8: PM Motor Control Tuning . . . . .	1001
11.11	o: Keypad-Related Settings . . . . .	1010
	o1: Keypad Display Selection . . . . .	1010
	o2: Keypad Operation . . . . .	1017
	o3: Copy Function . . . . .	1021
	o4: Maintenance Mon Settings . . . . .	1023
	o5: Log Function . . . . .	1026
11.12	T: Auto-Tuning . . . . .	1032
	T0: Tuning Mode Selection . . . . .	1032
	T1: InductionMotor Auto-Tuning . . . . .	1032
	T2: PM Motor Auto-Tuning . . . . .	1035
	T3: ASR and Inertia Tuning . . . . .	1038
	T4: EZ Tuning . . . . .	1039
	Index . . . . .	1042
	Revision History . . . . .	1051



# Preface and General Precautions

---

This chapter gives information about important safety precautions for the use of this product. Failure to obey these precautions can cause serious injury or death, or damage to the product or related devices and systems. Yaskawa must not be held responsible for any injury or equipment damage as a result of the failure to observe these precautions and instructions.

<b>i.1</b>	<b>Receiving</b> .....	<b>14</b>
<b>i.2</b>	<b>Using the Product Safely</b> .....	<b>15</b>
<b>i.3</b>	<b>Warranty Information</b> .....	<b>18</b>

## i.1 Receiving

These instructions contain the information necessary to use the product correctly. Read and understand the safety information and precautions before you start to use the product.

### ◆ Glossary

Phrase	Definition
AOLV	Advanced Open Loop Vector Control
AOLV/PM	Advanced Open Loop Vector Control for Permanent Magnet Motors
CLV	Closed Loop Vector Control
CL-V/f	Closed Loop V/f Control
CLV/PM	Closed Loop Vector Control for Permanent Magnet Motors
Drive	YASKAWA AC Drive GA700
EDM	External Device Monitor
EZOLV	EZ Open Loop Vector Control
HD	Heavy Duty
IPM Motor	Yaskawa SSR1-Series and SST4-Series motors
MFAI	Multi-Function Analog Input
MFAO	Multi-Function Analog Output
MFDI	Multi-Function Digital Input
MFDO	Multi-Function Digital Output
ND	Normal Duty
OLV	Open Loop Vector Control
OLV/PM	Open Loop Vector Control for Permanent Magnet Motors
PM motor	Permanent Magnet Synchronous motor (generic name for IPM motors and SPM motors)
SIL	Safety Integrity Level
SPM Motor	Yaskawa SMRA-Series motors
V/f	V/f Control

### ◆ About Registered Trademarks

- CANopen is a registered trademark of CAN in Automation (CIA).
- CC-Link is a registered trademark of CC-Link Partner Association.
- DeviceNet is a registered trademark of Open DeviceNet Vendor Association, Inc. (ODVA).
- EtherCAT is a registered trademark of Beckhoff Automation GmbH.
- EtherNet/IP is a registered trademark of Open DeviceNet Vendor Association, Inc. (ODVA).
- LonWorks and LonTalk are registered trademarks of Echelon Corporation.
- MECHATROLINK-I, MECHATROLINK-II, and MECHATROLINK-III are registered trademarks of MECHATROLINK Members Association (MMA).
- Modbus is a registered trademark of Schneider Electric SA.
- PROFIBUS-DP and PROFINET are registered trademarks of PROFIBUS International.
- Other company names and product names in this document are trademarks or registered trademarks of the respective companies.

## i.2 Using the Product Safely

### ◆ Supplemental Safety Information

#### **⚠ WARNING**

**Read and understand this manual before you install, operate, or do maintenance on the drive. Install the drive as specified by this manual and local codes.**

The symbol marks in this section identify safety messages in this manual. Failure to obey these safety messages can cause serious injury, death, or damage to the products and related equipment and systems.

These identifier words categorize and emphasize important safety precautions in these instructions.

#### **⚠ DANGER**

**Identifies a hazardous situation, which, if not avoided, will cause death or serious injury.**

#### **⚠ WARNING**

**Identifies a hazardous situation, which, if not avoided, can cause death or serious injury.**

#### **⚠ CAUTION**

**Identifies a hazardous situation, which, if not avoided, can cause minor or moderate injury.**

#### **NOTICE**

**Identifies a property damage message.**

### ◆ General Safety

#### **General Precautions**

- Some figures in the instructions include options and drives without covers or safety shields to more clearly show the inside of the drive. Replace covers and shields before operation. Use options and drives only as specified by the instructions.
- The figures in this manual are examples only. All figures do not apply to all products included in this manual.
- Yaskawa can change the products, specifications, and content of the instructions without notice to make the product and/or the instructions better.
- If you damage or lose these instructions, contact a Yaskawa representative or the nearest Yaskawa sales office on the rear cover of the manual, and tell them the document number on the front cover to order new copies.

#### **⚠ DANGER**

**Do not ignore the safety messages in this manual. The operating company is responsible for injuries or equipment damage caused from ignoring the messages in this manual.**

Failure to obey the safety messages will cause death or serious injury.

#### **Electrical Shock Hazard**

**Do not examine, connect, or disconnect wiring on an energized drive. Before servicing, disconnect all power to the equipment and wait for the time specified on the warning label at a minimum. The internal capacitor stays charged after the drive is de-energized. The charge indicator LED extinguishes when the DC bus voltage decreases below 50 Vdc. When all indicators are OFF, remove the covers before measuring for dangerous voltages to make sure that the drive is safe.**

Failure to obey will cause death or serious injury.

**⚠ WARNING**

**Crash Hazard**

**Test the system to make sure that the drive operates safely after you wire the drive and set parameters.**

Failure to obey can cause injury or damage to equipment.

**Sudden Movement Hazard**

**Make sure that the setting values for virtual input and output function parameters are correct before a test run. Virtual input and output functions can have different default settings and operation.**

Failure to obey can cause injury or death.

**Remove all persons and objects from the area around the drive, motor, and machine area and attach covers, couplings, shaft keys, and machine loads before energizing the drive.**

Failure to obey can cause death or serious injury.

**When you use DriveWorksEZ to make custom programming, the drive I/O terminal functions change from factory settings and the drive will not operate as written in this manual. Examine the I/O signals and internal sequence with the engineer who made the DriveWorksEZ program before operation.**

Failure to obey can cause death or serious injury.

**Electrical Shock Hazard**

**Do not make changes to the drive body or drive circuitry.**

Failure to obey can cause death or serious injury and will void warranty. Yaskawa is not responsible for changes to the product made by the user.

**Only let authorized persons install, wire, maintain, examine, replace parts, and repair the drive.**

Failure to obey can cause death or serious injury.

**Do not remove covers or touch circuit boards while the drive is energized.**

Failure to obey can cause death or serious injury.

**Do not immediately energize the drive or operate peripheral devices after the drive blows a fuse or trips an RCM/RCD. Wait for the time specified on the warning label at a minimum and make sure that all indicators are OFF. Then check the wiring and peripheral device ratings to find the cause of the problem. Contact Yaskawa before energizing the drive or peripheral devices if the cause is not known.**

Failure to obey can cause death or serious injury and damage to the drive.

**Fire Hazard**

**Do not use the main circuit power supply (Overcurrent Category III) at incorrect voltages. Make sure that the drive rated voltage aligns with the power supply voltage before energizing the drive.**

Failure to obey can cause death or serious injury.

**Install sufficient branch circuit short circuit protection as specified by applicable codes and this manual. The drive is suited for circuits that supply not more than 100,000 RMS symmetrical amperes, 240 Vac maximum (200 V Class), 480 Vac maximum (400 V Class).**

Failure to obey can cause death or serious injury.

**⚠ CAUTION**

**Crush Hazard**

**Do not hold the drive by the front cover or terminal cover. Tighten the screws correctly before moving the drive.**

Failure to obey can cause minor to moderate injury.



## NOTICE

**Use a motor that provides insulation correct for PWM drives.**

Failure to obey can cause a short circuit or ground fault from insulation deterioration.

**Observe correct electrostatic discharge (ESD) procedures when touching the drive and circuit boards.**

Failure to obey can cause ESD damage to the drive circuitry.

**Do not do a withstand voltage test or Megger test on the drive.**

Failure to obey can cause damage to the drive.

**Do not connect or operate damaged equipment or equipment with missing parts.**

Failure to obey can cause damage to the drive and connected equipment.

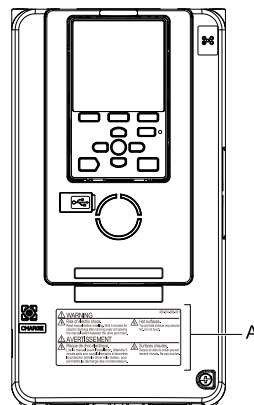
**If it is necessary to use disinfectant or to debug wood material for packaging, use a method other than steam. Example: Heat treatment (core at 56 °C [133 °F] or higher for more than 30 minutes)**

Gas steam from fumigated wooden packaging materials can cause damage to electrical components. Halogen disinfectants (fluorine, chlorine, bromine, and iodine) erode capacitors, and DOP gas (phthalic acid ester) cracks resin materials. Do all treatment procedures before packaging components.

### ◆ Warning Label Content and Location

The drive warning label is in the location shown in [Figure i.1](#). Use the drive as specified by this information.

400-091-893-001	
<p><b>⚠ WARNING</b></p> <p><b>⚡ Risk of electric shock.</b> Read manual before installing. Wait 5 minutes for capacitor discharge after removing power and opening the manual switch between the drive and motor.</p>	<p><b>🔥 Hot surfaces.</b> Top and Side surfaces may become hot. Do not touch.</p>
<b>⚠ AVERTISSEMENT</b>	
<p><b>⚡ Risque de choc électrique.</b> Lire le manuel avant l'installation. Attendre 5 minutes après avoir coupé l'alimentation et déconnecté la protection entre le driver et le moteur, pour permettre la décharge des condensateurs.</p>	<p><b>🔥 Surfaces chaudes.</b> Dessus et cotés du boîtier peuvent devenir chauds. Ne pas toucher.</p>



**A - Warning label**

**Figure i.1 Warning Label Content and Location**

## **i.3 Warranty Information**

---

### **◆ Warranty and Exclusion of Liability**

- This product is not designed and manufactured for use in life-support machines or systems.
- Contact a Yaskawa representative or your Yaskawa sales representative if you are considering the application of this product for special purposes, such as machines or systems used for passenger cars, medicine, airplanes and aerospace, nuclear power, electric power, or undersea relaying.

### **⚠ WARNING**

#### **Injury to Personnel**

**Yaskawa manufactured this product with strict quality-control guidelines. Install applicable safety devices to minimize the risk of accidents when installing the product where its failure could cause a life-or-death situation, loss of human life, or a serious accident or physical injury.**

## Receiving

---

This chapter gives information about the different drive models and features, and how to examine the drive when you receive it.

<b>1.1</b>	<b>Section Safety .....</b>	<b>20</b>
<b>1.2</b>	<b>Model Number and Nameplate Check.....</b>	<b>21</b>
<b>1.3</b>	<b>Features and Advantages of Control Methods.....</b>	<b>26</b>

## 1.1 Section Safety

### **DANGER**

**Do not ignore the safety messages in this manual. The operating company is responsible for injuries or equipment damage caused from ignoring the messages in this manual.**

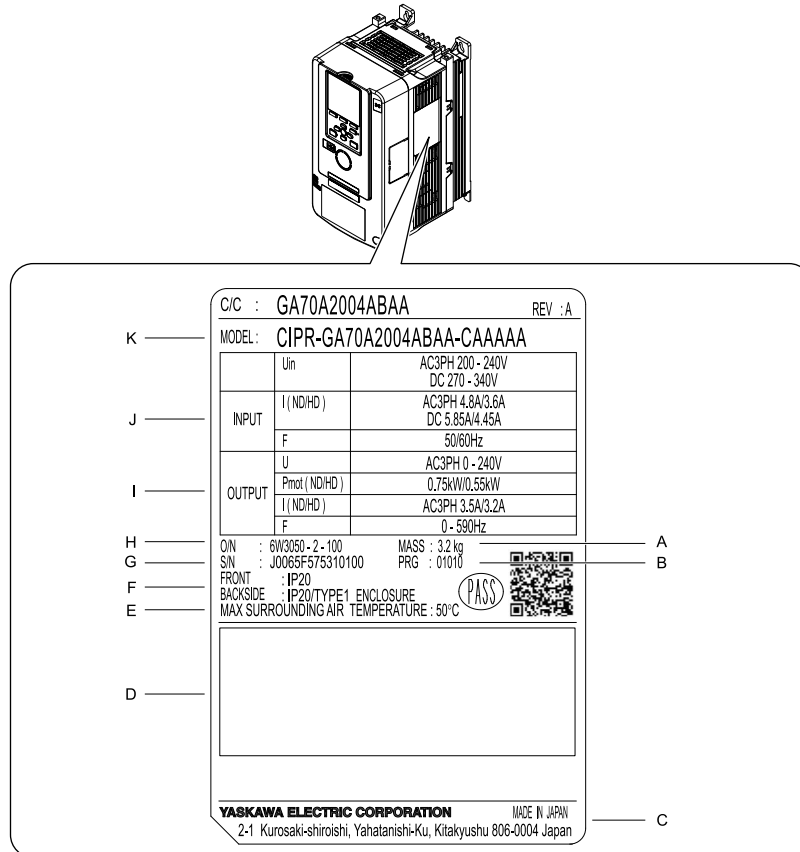
Failure to obey the safety messages will cause death or serious injury.

## 1.2 Model Number and Nameplate Check

Please check these items after receiving the drive:

- Examine the drive for damage. Immediately contact the shipping company if the drive is damaged. The Yaskawa warranty does not cover damage from shipping.
- Verify the drive model number in the "MODEL" section of the drive nameplate to make sure that you received the correct model.
- Contact your supplier if you receive the incorrect drive model or if the drive does not operate correctly.

### ◆ Nameplate



- |  |                           |
|--|---------------------------|
| A - Mass   | G - Serial number         |
| B - Drive software version   | H - Lot number            |
| C - The address of the head office of Yaskawa Electric Corporation | I - Output specifications |
| D - Accreditation standards  | J - Input specifications  |
| E - Surrounding air temperature                                    | K - Drive model           |
| F - Protection design  |                           |

Figure 1.1 Nameplate Information Example

### ◆ How to Read Model Numbers

Use the information in [Figure 1.2](#) and [Table 1.1](#) to read the drive model numbers.

CIPR- GA70 A 2 004 A B A A - C A A A A A

1 2 3 4 5 6 7 8 9 10 11 12 13 14 15

Figure 1.2 Drive Model Number

## 1.2 Model Number and Nameplate Check

**Table 1.1 Model Number Details**

No	詳細
1	Drive
2	Product series
3	Region code <ul style="list-style-type: none"> <li>• A: Japan</li> <li>• B: China</li> <li>• C: Europe</li> <li>• D: India</li> <li>• K: Korea</li> <li>• T: Asia (Singapore and Taiwan)</li> <li>• U: the Americas</li> </ul>
4	Input power supply voltage <ul style="list-style-type: none"> <li>• 2: Three-Phase AC 200 V</li> <li>• 4: Three-Phase AC 400 V</li> </ul>
5	Rated output current <b>Note:</b> Refer to the rated output current list for more information.
6	EMC noise filter <ul style="list-style-type: none"> <li>• A: No internal EMC filter</li> <li>• B: Internal category C3 EMC filter</li> <li>• C: Internal category C2 EMC filter</li> </ul>
7	Protection design <ul style="list-style-type: none"> <li>• B: IP20</li> <li>• F: IP20, UL Type 1</li> </ul>
8	Environmental specification (Reserved)
9	Design revision order
10	Control circuit terminal board (Reserved)
11	Option card (connector CN5-A) (Reserved)
12	Option card (connector CN5-B) (Reserved)
13	Option card (connector CN5-C) (Reserved)
14	Keypad (Reserved)
15	Special applications (Reserved)

### ■ Rated Output Current

Table 1.2 to Table 1.4 give the rated output current values.

**Note:**

- These output current values are applicable for drives that operate at standard specifications.
- Derate the current in applications that:
  - Increase the carrier frequency
  - Have high ambient temperature
  - Install drives side-by-side.
- Use C6-01 [*Normal / Heavy Duty Selection*] to select Normal Duty rating (ND) or Heavy Duty rating (HD).

**Table 1.2 Three-Phase AC 200 V Class**

No.	Heavy Duty Rating (HD) [C6-01 = 0] (Default)		Normal Duty Rating (ND) [C6-01 = 1]	
	Maximum Applicable Motor Output kW	Rated Output Current A	Maximum Applicable Motor Output kW	Rated Output Current A
004	0.55	3.2	0.75	3.5
006	0.75	5	1.1	6

No.	Heavy Duty Rating (HD) [C6-01 = 0] (Default)		Normal Duty Rating (ND) [C6-01 = 1]	
	Maximum Applicable Motor Output kW	Rated Output Current A	Maximum Applicable Motor Output kW	Rated Output Current A
010	1.5	8	2.2	9.6
012	2.2	11	3	12.2
018	3	14	4	17.5
021	4	17.5	5.5	21
030	5.5	25	7.5	30
042	7.5	33	11	42
056	11	47	15	56
070	15	60	18.5	70
082	18.5	75	22	82
110	22	88	30	110
138	30	115	37	138
169	37	145	45	169
211	45	180	55	211
257	55	215	75	257
313	75	283	90	313
360	90	346	110	360
415	110	415	-	-

Table 1.3 Three-Phase AC 400 V Class (Input Voltage &lt; 460 V)

No.	E1-01 [Input AC Supply Voltage] < 460			
	Heavy Duty Rating (HD) [C6-01 = 0] (Default)		Normal Duty Rating (ND) [C6-01 = 1]	
	Maximum Applicable Motor Output kW	Rated Output Current A	Maximum Applicable Motor Output kW	Rated Output Current A
002	0.55	1.8	0.75	2.1
004	1.1	3.4	1.5	4.1
005	1.5	4.8	2.2	5.4
007	2.2	5.5	3.0	7.1
009	3.0	7.2	4.0	8.9
012	4.0	9.2	5.5	11.9
018	5.5	14.8	7.5	17.5
023	7.5	18	11	23.4
031	11	24	15	31
038	15	31	18.5	38
044	18.5	39	22	44
060	22	45	30	59.6
075	30	60	37	74.9
089	37	75	45	89.2
103	45	91	55	103
140	55	112	75	140

## 1.2 Model Number and Nameplate Check

No.	E1-01 [Input AC Supply Voltage] < 460			
	Heavy Duty Rating (HD) [C6-01 = 0] (Default)		Normal Duty Rating (ND) [C6-01 = 1]	
	Maximum Applicable Motor Output kW	Rated Output Current A	Maximum Applicable Motor Output kW	Rated Output Current A
168	75	150	90	168
208	90	180	110	208
250	110	216	132	250
296	132	260	160	296
371	160	304	200	371
389	200	371	220	389
453	220	414	250	453
568	250	453	315	568
675	315	605	355	675

**Table 1.4 Three-Phase AC 400 V Class (Input Voltage  $\geq$  460 V)**

No.	E1-01 [Input AC Supply Voltage] $\geq$ 460			
	Heavy Duty Rating (HD) [C6-01 = 0] (Default)		Normal Duty Rating (ND) [C6-01 = 1]	
	Maximum Applicable Motor Output HP	Rated Output Current A	Maximum Applicable Motor Output HP	Rated Output Current A
002	3/4	1.6	1	2.1
004	1	2.1	2	3
005	2	3.4	3	4.8
007	3	4.8	4	6.9
009	4	6.9	5	7.6
012	5	7.6	7 1/2	11
018	7 1/2	11	10	14
023	10	14	15	21
031	15	21	20	27
038	20	27	25	34
044	25	34	30	40
060	30	40	40	52
075	40	52	50	65
089	50	65	60	77
103	60	77	75	96
140	75	96	100	124
168	100	124	125	156
208	125	156	150	180
250	150	180	200	240
296	200	240	250	302
371	250	302	300	361
389	300	361	350	414
453	350	414	400	477



No.	E1-01 [Input AC Supply Voltage] $\geq$ 460			
	Heavy Duty Rating (HD) [C6-01 = 0] (Default)		Normal Duty Rating (ND) [C6-01 = 1]	
	Maximum Applicable Motor Output HP	Rated Output Current A	Maximum Applicable Motor Output HP	Rated Output Current A
568	400	477	450	515
675	-	-	-	-

## 1.3 Features and Advantages of Control Methods

This drive has 9 available control methods from which to select for different applications. [Table 1.5](#), [Table 1.6](#) and [Table 1.7](#) gives information about the features of each control method.

**Table 1.5 V/f and CL-V/f Features and Advantages of Control Methods**

Control Method Selection	Open Loop V/f Control (V/f)	Closed Loop V/f Control (CL-V/f)	Notes
<b>Controlled Motor</b>	<b>Induction Motor</b>		-
Parameter Settings	A1-02 = 0	A1-02 = 1	-
Basic Control	V/f	Closed loop V/f control with speed correction	-
Main Applications	General-purpose variable speed control to connect more than one motor to one drive.	High-precision speed control with encoders on machines	-
PG Option Card	Not necessary	Necessary (PG-B3 or PG-X3)	-
Maximum Output Frequency	590 Hz	400 Hz	-
Speed Control Range	1:40	1:40	This is the range of variable control. When you connect and operate motors in this method, think about the increase in motor temperature.
Starting Torque	150% / 3 Hz	150% / 3 Hz	This is the motor torque that the drive can supply at low speed during start-up and the related output frequency (rotation speed). You must think about drive capacity when a large quantity of torque is necessary at low speed.
Auto-Tuning <sup>*1</sup>	Rotational and Line-to-Line Resistance (usually not necessary)	Rotational and Line-to-Line Resistance (usually not necessary)	Automatically tunes electrical motor parameters.
Torque Limits <sup>*1</sup>	No	No	Controls maximum motor torque to prevent damage to machines and loads.
Torque Control <sup>*1</sup>	No	No	Directly controls motor torque to control tension and other parameters.
Droop Control <sup>*1</sup>	No	No	Sets load torque slip for motors. Distributes motor loads.
Zero Servo Control <sup>*1</sup>	No	No	Locks servos without an external position controller to prevent movement caused by external force.
Speed Search <sup>*1</sup>	Yes	-	Immediately estimates (or detects) motor speed and direction when coasting to a stop to quickly start-up the drive without stopping the motor.
Automatic Energy-saving Control <sup>*1</sup>	Yes	Yes	Automatically adjusts the voltage applied to motors to maximize motor efficiency for all load sizes.
High Slip Braking (HSB) <sup>*1</sup>	Yes	Yes	Increases motor loss to let the motor decelerate faster than usual without a braking resistor. Motor characteristics have an effect on this function.
Feed Forward Control <sup>*1</sup>	No	No	Compensates effects of the system inertia to increase the speed precision when the load changes.
KEB Ride-Thru Function <sup>*1</sup>	Yes	Yes	Quickly and safely stops the motor during power loss and automatically starts operation at the previous speed when restores power without coasting the motor.

Control Method Selection	Open Loop V/f Control (V/f)	Closed Loop V/f Control (CL-V/f)	Notes
<b>Controlled Motor</b>	<b>Induction Motor</b>		-
Overexcitation Deceleration <sup>*1</sup>	Yes	Yes	Sets the V/f higher than the setting value during deceleration to increase motor loss and decrease deceleration time.
Overvoltage Suppression Function <sup>*1</sup> <sup>*2</sup>	Yes	Yes	Adjusts speed during regeneration to prevent overvoltage.

\*1 Note these points when you use this function:

- When you can decouple the motor and machine for a test run, use Rotational Auto-Tuning. You must make adjustments to the control in the range where there is no vibration in the machine after Rotational Auto-Tuning.
- Motor loss increases during overexcitation braking and high-slip braking. Use a maximum braking frequency of 5% ED and a maximum braking time of 90 seconds. After you start high-slip braking, you cannot restart the motor until it stops. Use overexcitation braking to decelerate over a shorter time at a pre-determined speed.

\*2 Do not use this function with hoist application.

**Table 1.6 OLV, CLV and AOLV Features and Advantages of Control Methods**

Control Method Selection	Open Loop Vector Control (OLV)	Closed Loop Vector Control (CLV)	Advanced Open Loop Vector Control (AOLV)	Notes
<b>Controlled Motor</b>	<b>Induction Motor</b>			-
Parameter Settings	A1-02 = 2 (Default)	A1-02 = 3	A1-02 = 4	-
Basic Control	Open Loop Current Vector Control	Closed Loop Current Vector Control	Open Loop Current Vector Control	-
Main Applications	<ul style="list-style-type: none"> <li>• General-purpose variable speed control</li> <li>• Applications in which high performance is necessary without machine encoders</li> </ul>	Very high-performance control with motor encoders Example: High-precision speed control, torque control, torque limits	Sensorless vector control with speed control <ul style="list-style-type: none"> <li>• General-purpose variable speed control</li> <li>• Applications in which high performance is necessary without machine encoders</li> </ul>	-
PG Option Card	Not necessary	Necessary (PG-B3 or PG-X3)	Not necessary	-
Maximum Output Frequency	590 Hz	400 Hz	120 Hz	-
Speed Control Range	1:200	1:1500	1:200	This is the range of variable control. When you connect and operate motors in this mode, think about the increase in motor temperature.
Starting Torque	200% / 0.3 Hz <sup>*1</sup>	200% / 0 min <sup>-1</sup> <sup>*1</sup>	200% / 0.3 Hz <sup>*1</sup>	This is the motor torque that the drive can supply at low speed during start-up and the related output frequency (rotation speed). You must think about drive capacity when a large quantity of torque is necessary at low speed.
Auto-Tuning <sup>*2</sup>	Rotational, Stationary, and Line-to-Line Resistance	Rotational, Stationary, and Line-to-Line Resistance	Rotational, Stationary, and Line-to-Line Resistance	Automatically tunes electrical motor parameters.
Torque Limits <sup>*2</sup>	Yes	Yes	Yes	Controls maximum motor torque to prevent damage to machines and loads.
Torque Control <sup>*2</sup>	No	Yes	Yes (Although NOT low speeds of approximately 10% or less)	Directly controls motor torque to control tension and other parameters.
Droop Control <sup>*2</sup>	No	Yes	Yes	Sets load torque slip for motors. Distributes motor loads.

### 1.3 Features and Advantages of Control Methods

Control Method Selection	Open Loop Vector Control (OLV)	Closed Loop Vector Control (CLV)	Advanced Open Loop Vector Control (AOLV)	Notes
Controlled Motor	Induction Motor			-
Zero Servo Control *2	No	Yes	No	Locks servos without an external position controller to prevent movement caused by external force.
Speed Search *2	Yes	-	Yes	Immediately estimates (or detects) motor speed and direction when coasting to a stop to quickly start-up the drive without stopping the motor.
Automatic Energy-saving Control *2	Yes	Yes	No	Automatically adjusts the voltage applied to motors to maximize motor efficiency for all load sizes.
High Slip Braking (HSB) *2	No	No	No	Increases motor loss to let the motor decelerate faster than usual without a braking resistor. Motor characteristics have an effect on this function.
Feed Forward Control *2	No	Yes	Yes	Compensates effects of the system inertia to increase the speed precision when the load changes.
KEB Ride-Thru Function *2	Yes	Yes	Yes	Quickly and safely stops the motor during power loss and automatically starts operation at the previous speed when restores power without coasting the motor.
Overexcitation Deceleration *2	Yes	Yes	Yes	Sets the V/f higher than the setting value during deceleration to increase motor loss and decrease deceleration time.
Overvoltage Suppression Function *2 *3	Yes	Yes	Yes	Adjusts speed during regeneration to prevent overvoltage.

\*1 Select the drive capacity accordingly.

\*2 Note these points when you use this function:

- When you can decouple the motor and machine for a test run, use Rotational Auto-Tuning. You must make adjustments to the control in the range where there is no vibration in the machine after Rotational Auto-Tuning.
- For vector control, use a 1:1 drive to motor ratio. You cannot use vector control when more than one motor is connected to one drive. Select a drive capacity so that the motor rated current is 50% to 100% of the drive rated current. If the carrier frequency is too high, the drive rated current is derated.
- Motor loss increases during overexcitation braking and high-slip braking. Use a maximum braking frequency of 5% ED and a maximum braking time of 90 seconds. After you start high-slip braking, you cannot restart the motor until it stops. Use overexcitation braking to decelerate over a shorter time at a pre-determined speed.
- Acceleration and deceleration have priority over torque limits in Open Loop Vector Control during acceleration and deceleration (soft start changes). The drive will not operate until the speed is at the minimum frequency or the reverse direction of motor rotation when the motor speed decreases because of torque limits during constant speed control. Set  $L7-07 = 1$  [*Torque Limit during Accel/Decel = Proportional & Integral control*] to enable torque limits during acceleration/deceleration (for winding applications).

\*3 Do not use this function with hoist application.

Table 1.7 OLV/PM, AOLV/PM, CLV/PM and EZOLV Features and Advantages of Control Methods

Control Method Selection	PM Open Loop Vector Control (OLV/PM)	PM Advanced Open Loop Vector Control (AOLV/PM)	PM Closed Loop Vector Control (CLV/PM)	EZ Open Loop Vector Control (EZOLV)	Notes
Controlled Motor	PM Motor			Induction Motors/ PM Motors/SynRM (Synchronous Reluctance Motors)	-
Parameter Settings	A1-02 = 5	A1-02 = 6	A1-02 = 7	A1-02 = 8	-
Basic Control	PM Open Loop Vector Control (no speed controller)	PM Open Loop Current Vector Control (with speed controller)	PM Closed Loop Current Vector Control (with speed controller)	Open Loop Current Vector Control	-
Main Applications	<ul style="list-style-type: none"> <li>General-purpose variable speed control for PM motors</li> <li>Applications in which a high level of responsiveness and accurate speed control are not necessary.</li> </ul>	<ul style="list-style-type: none"> <li>General-purpose variable speed control for IPM motors</li> <li>Applications in which high-precision speed control and torque limits are necessary.</li> </ul>	Very high-performance PM motor control with motor encoders Example: Torque control and torque limits	Low-speed torque applications Example: Fans and pumps	-
PG Option Card	Not necessary	Not necessary	Necessary (PG-X3)	Not necessary	-
Maximum Output Frequency	590 Hz	400 Hz	400 Hz	120 Hz	-
Speed Control Range	1:20 AM	1:20 AM 1:100 *1 *2 *3	1:1500	1:100	This is the range of variable control. When you connect and operate motors in this mode, think about the increase in motor temperature.
Starting Torque	100% / 5% speed	100% / 5% speed 200% / 0 min <sup>-1</sup> *1	200% / 0 min <sup>-1</sup> *4	100% / 1% speed	This is the motor torque that the drive can supply at low speed during start-up and the related output frequency (rotation speed). You must think about drive capacity when a large quantity of torque is necessary at low speed.
Auto-Tuning *5	Stationary, Stator Resistance, Rotational	Stationary, Stator Resistance, Rotational	Stationary, Stator Resistance, Z-phase, Rotational	Line-to-Line Resistance	Automatically tunes electrical motor parameters.
Torque Limits *5	No	Yes	Yes	Yes	Controls maximum motor torque to prevent damage to machines and loads.
Torque Control *5	No	Yes *6	Yes	No	Directly controls motor torque to control tension and other parameters.
Droop Control *5	No	No	Yes	No	Sets load torque slip for motors. Distributes motor loads.
Zero Servo Control *5	No	No	Yes	No	Locks servos without an external position controller to prevent movement caused by external force.

### 1.3 Features and Advantages of Control Methods

Control Method Selection	PM Open Loop Vector Control (OLV/PM)	PM Advanced Open Loop Vector Control (AOLV/PM)	PM Closed Loop Vector Control (CLV/PM)	EZ Open Loop Vector Control (EZOLV)	Notes
Controlled Motor	PM Motor			Induction Motors/ PM Motors/SynRM (Synchronous Reluctance Motors)	-
Speed Search *5	Yes	Yes	Yes	Yes (Although NOT operation in the reverse direction of the Run command)	Immediately estimates (or detects) motor speed and direction when coasting to a stop to quickly start-up the drive without stopping the motor.
Automatic Energy-saving Control *5	No	Yes (IPM motors only)	Yes (IPM motors only)	Yes	Automatically adjusts the voltage applied to motors to maximize motor efficiency for all load sizes.
High Slip Braking (HSB)	No (induction motor-specific function)	No (induction motor-specific function)	No (induction motor-specific function)	No	Increases motor loss to let the motor decelerate faster than usual without a braking resistor. Motor characteristics have an effect on this function.
Feed Forward Control *5	No	Yes	Yes	No	Compensates effects of the system inertia to increase the speed precision when the load changes.
KEB Ride-Thru Function *5	Yes	Yes	Yes	Yes	Quickly and safely stops the motor during power loss and automatically starts operation at the previous speed when restores power without coasting the motor.
Overexcitation Deceleration	No (induction motor-specific function)	No (induction motor-specific function)	No (induction motor-specific function)	No	Sets the V/f higher than the setting value during deceleration to increase motor loss and decrease deceleration time.
Overvoltage Suppression Function *5 *7	Yes	Yes	Yes	Yes	Adjusts speed during regeneration to prevent overvoltage.
Sensorless Zero Speed Control *5	No	Yes (IPM motors only)	-	No	Enabled with high frequency injection with IPM motors.

\*1 Enabled when  $n8-57 = 1$  [*HFI Overlap Selection = Enabled*].

\*2 Rotational Auto-Tuning is necessary.

\*3 Contact Yaskawa or your nearest sales representative to drive non-Yaskawa PM motors (SSR1 and SST4 series standard specifications).

\*4 Select the drive capacity accordingly.

\*5 Note these points when you use this function:

- When you can decouple the motor and machine for a test run, use Rotational Auto-Tuning. You must make adjustments to the control in the range where there is no vibration in the machine after Rotational Auto-Tuning.
- For vector control, use a 1:1 drive to motor ratio. You cannot use vector control when more than one motor is connected to one drive. Select a drive capacity so that the motor rated current is 50% to 100% of the drive rated current. If the carrier frequency is too high, the drive rated current is derated.

\*6 Torque control at zero speed is only available with IPM motors. To enable torque control with IPM motors at zero speed, set  $n8-57 = 1$ .

\*7 Do not use this function with hoist application.

# Mechanical & Electrical Installation

---

This chapter explains how to properly mount and install the drive, and to wire the control circuit terminals, motor, and power supply.

<b>2.1</b>	<b>General Safety</b> .....	<b>32</b>
<b>2.2</b>	<b>Installation Environment</b> .....	<b>35</b>
<b>2.3</b>	<b>Installation Position and Distance</b> .....	<b>36</b>
<b>2.4</b>	<b>Moving the Drive</b> .....	<b>38</b>
<b>2.5</b>	<b>Drive Watt Loss</b> .....	<b>40</b>
<b>2.6</b>	<b>Remove and Reattach the Keypad</b> .....	<b>44</b>
<b>2.7</b>	<b>Install the Keypad to a Control Panel or Another Device</b> .....	<b>45</b>
<b>2.8</b>	<b>Removing/Reattaching Covers</b> .....	<b>50</b>
<b>2.9</b>	<b>Change the Drive Enclosure Type</b> .....	<b>55</b>
<b>2.10</b>	<b>Installation Methods</b> .....	<b>68</b>
<b>2.11</b>	<b>Electrical Installation</b> .....	<b>73</b>
<b>2.12</b>	<b>Main Circuit Wiring</b> .....	<b>76</b>
<b>2.13</b>	<b>Main Circuit Terminal Block Wiring Procedure</b> .....	<b>98</b>
<b>2.14</b>	<b>Control Circuit Wiring</b> .....	<b>104</b>
<b>2.15</b>	<b>Control I/O Connections</b> .....	<b>113</b>
<b>2.16</b>	<b>Connect the Drive to a PC</b> .....	<b>117</b>
<b>2.17</b>	<b>External Interlock</b> .....	<b>118</b>
<b>2.18</b>	<b>Braking Resistor Installation</b> .....	<b>119</b>
<b>2.19</b>	<b>Drive Wiring Protection</b> .....	<b>122</b>
<b>2.20</b>	<b>Dynamic Braking Option, Motor Protection</b> .....	<b>123</b>
<b>2.21</b>	<b>Improve the Power Factor</b> .....	<b>125</b>
<b>2.22</b>	<b>Prevent Switching Surge</b> .....	<b>126</b>
<b>2.23</b>	<b>Decrease Noise</b> .....	<b>127</b>
<b>2.24</b>	<b>Protect the Drive during Failures</b> .....	<b>129</b>
<b>2.25</b>	<b>Wiring Checklist</b> .....	<b>133</b>
<b>2.26</b>	<b>Motor Application Precautions</b> .....	<b>135</b>

## 2.1 General Safety

### DANGER

#### Electrical Shock Hazard

**Do not examine, connect, or disconnect wiring on an energized drive. Before servicing, disconnect all power to the equipment and wait for the time specified on the warning label at a minimum. The internal capacitor stays charged after the drive is de-energized. The charge indicator LED extinguishes when the DC bus voltage decreases below 50 Vdc. When all indicators are OFF, remove the covers before measuring for dangerous voltages to make sure that the drive is safe.**

Failure to obey will cause death or serious injury.

### WARNING

#### Electrical Shock Hazard

**Do not operate equipment when covers are missing. Some figures in this section include drives without covers or safety shields to more clearly show the inside of the drive. Replace covers and shields before operation. Use drives only as specified by the instructions.**

Failure to obey can cause death or serious injury.

**Ground the neutral point on the power supply of drive models 2xxxB/C and 4xxxA/B/C to comply with the EMC Directive before turning on the EMC filter or if there is high resistance grounding.**

If the EMC filter is switched ON without the neutral point being grounded or if there is high resistance grounding, it can cause death or serious injury.

**The leakage current of the drive will be more than 3.5 mA in drive models 2xxxB, 2xxxC, 4002B to 4371B, 4002C to 4371C (with built-in EMC filter turned ON) and 4389 to 4675. The IEC/EN 61800-5-1: 2007 standard specifies that users must wire the power supply to automatically turn off when the protective ground wire disconnects. Users can also connect a protective ground wire that has a minimum cross-sectional area of 10 mm<sup>2</sup> (copper wire) or 16 mm<sup>2</sup> (aluminum wire).**

Failure to obey these standards can cause death or serious injury.

**Always use a type B Residual Current Monitor/Residual Current Device (RCM/RCD) where a residual current operated protective or monitoring device protects against direct or indirect contact as specified by IEC/EN 60755. The drive can cause a residual current with a DC component in the protective earthing conductor.**

Failure to obey can cause death or serious injury.

**Do not work on the drive or around the drive while wearing loose clothing or jewelry. Tighten loose clothing and remove all metal objects such as watches or rings.**

Failure to obey can cause death or serious injury.

**Do not remove covers or touch circuit boards while the drive is energized.**

Failure to obey can cause death or serious injury.

**Only let authorized persons install, wire, maintain, examine, replace parts, and repair the drive.**

Failure to obey can cause death or serious injury.

**Do not make changes to the drive body or drive circuitry.**

Failure to obey can cause death or serious injury and will void warranty. Yaskawa is not responsible for changes to the product made by the user.

#### Fire Hazard

**Tighten all terminal screws to the correct tightening torque.**

Connections that are too loose or too tight can cause incorrect operation and damage to the drive. Incorrect connections can also cause death or serious injury from fire.

**Tighten screws against the bit at an angle in the specified range shown in this manual.**

If you tighten the screws at an angle not in the specified range, you can have loose connections that can cause damage to the terminal block or start a fire.



**⚠ WARNING**

**Do not put flammable or combustible materials on top of the drive and do not install the drive near flammable or combustible materials. Attach the drive to metal or other noncombustible material.**

Failure to obey can cause death or serious injury.

**Do not use the main circuit power supply (Overcurrent Category III) at incorrect voltages. Make sure that the drive rated voltage aligns with the power supply voltage before energizing the drive.**

Failure to obey can cause death or serious injury.

**When installing dynamic braking options, wire the components as specified by the wiring diagrams.**

Failure to obey can result in fire, death or serious injury. Incorrect wiring can cause damage to braking components.

**When installing the drive into a closed cabin or cabinet, use a cooling fan or cooler to decrease the temperature around the drive. Make sure that the intake air temperature to the drive is 50 °C (122 °F) or less for open chassis type drives, (IP20) and 40 °C (104 °F) or less for enclosed wall-mounted type (UL Type1) drives.**

Failure to obey can cause the drive to overheat and cause fire, death or serious injury.

**Crush Hazard**

**Only approved personnel can operate a crane or hoist to move the drive.**

Failure to obey can cause death or serious injury from falling equipment.

**Use screws to correctly attach the drive front cover, terminal blocks, and other drive components before hanging the drive vertically.**

Failure to obey can cause serious injury or death from falling equipment.

**Prevent more than 1.96 m/s<sup>2</sup> (0.2 G) vibration and impact to a hanging drive.**

Failure to obey can cause death or serious injury from falling equipment.

**Do not try to flip over a hanging drive or leave a hanging drive unattended.**

Failure to obey can cause death or serious injury from falling equipment.

**Use a lifting mechanism made to move large drives when necessary.**

Failure to obey can cause death or serious injury from falling equipment.

**⚠ CAUTION****Crush Hazard**

**Do not hold the drive by the front cover or terminal cover. Tighten the screws correctly before moving the drive.**

Failure to obey can cause minor to moderate injury.

**NOTICE**

**Do not let unwanted objects, for example metal shavings or wire clippings, fall into the drive during drive installation and project construction. Put a temporary cover over the top of the drive during installation. Remove the temporary cover before start-up or the drive will overheat.**

Failure to obey can cause damage to the drive.

**Observe correct electrostatic discharge (ESD) procedures when touching the drive.**

Failure to obey can cause ESD damage to the drive circuitry.

**To use a standard blower-cooled motor, reduce the motor torque in the low-speed range. If 100% torque is continuously necessary at low speed, use a special motor or vector control motor. Select a motor that is compatible with the necessary load torque and operating speed range.**

Operating the motor in the low speed range decreases the cooling effects, increases motor temperature, and can cause overheating and motor damage.

## NOTICE

**The speed range for continuous operation will be different depending on the lubrication method and motor manufacturer. To operate the motor at a speed higher than the rated speed, contact the manufacturer.**

If you continuously operate an oil-lubricated motor in the low-speed range, it can cause burning.

**When the input voltage is 440 V or higher or the wiring distance is more than 100 meters, pay special attention to the motor insulation voltage or use a drive-rated motor with reinforced insulation.**

Failure to obey can cause motor winding failure.

**If you operated a machine at constant speed and then operated the same machine in variable-speed mode, motor vibration will increase.**

Install vibration-proof rubber on the motor base or use the frequency jump function to avoid the frequency that is resonating the machine.

**The motor may require more acceleration torque with drive operation than with a commercial power supply. Check the load torque characteristics of the machine to be used with the motor.**

**The rated input current of submersible motors is higher than the rated input current of standard motors. Use the rated output current to select an applicable drive. When the distance between the motor and drive is long, use a wire that can connect the motor to the drive without a reduction in motor torque.**

**To use an explosion-proof motor, you must do an explosion-proof test with the drive. As the drive is not explosion-proof, make sure that you install it in a safe area.**

Failure to obey could cause damage to the drive.

**Do not lift the drive with the cover removed.**

Failure to obey can cause damage to the drive board and terminal block.

**Do not use unshielded wire for control wiring. Use shielded, twisted-pair wires and ground the shield to the ground terminal of the drive.**

Failure to obey can cause electrical interference and unsatisfactory system performance.

**Do not allow unqualified personnel to use the product. Before you connect a dynamic braking option to the drive, make sure that you review Braking Unit and Braking Resistor Unit Installation Manual TOBPC72060001.**

Failure to obey can cause damage to the drive and braking circuit.

**Do not change the drive circuitry.**

Failure to obey can cause damage to the drive and will void warranty. Yaskawa is not responsible for modifications of the product made by the user.

**Make sure that all connections are correct after you install the drive and connecting peripheral devices.**

Failure to obey can cause damage to the drive.

## 2.2 Installation Environment

The installation environment is important for the lifespan of the product and to make sure that the drive performance is correct. Make sure that the installation environment agrees with these specifications.

Environment	Conditions
Area of Use	Indoors
Power Supply	Overvoltage Category III
Ambient Temperature Setting	<p>Open chassis type (IP20): -10°C to +50 °C (14 °F to 122 °F)            Enclosed wall-mounted type (UL Type 1): -10 °C to +40 °C (14 °F to 104 °F)</p> <ul style="list-style-type: none"> <li>• Drive reliability is better in environments that do not have wide temperature fluctuations.</li> <li>• When installing the drive in an enclosure, use a cooling fan or air conditioner to keep the internal air temperature in the permitted range.</li> <li>• Do not let the drive freeze.</li> <li>• To install the drive in areas with ambient temperatures <math>\leq 60</math> °C (140 °F), derate the output current and output voltage.</li> </ul>
Humidity	<p>95% RH or less            Do not let condensation form on the drive.</p>
Storage Temperature	-20 °C to +70 °C (-4 °F to +158 °F) (short-term temperature during transportation)
Surrounding Area	<p>Pollution degree 2 or less            Install the drive in an area without:</p> <ul style="list-style-type: none"> <li>• Oil mist, corrosive or flammable gas, or dust</li> <li>• Metal powder, oil, water, or other unwanted materials</li> <li>• Radioactive materials or flammable materials, including wood</li> <li>• Harmful gas or fluids</li> <li>• Salt</li> <li>• Direct sunlight</li> </ul> <p>Keep wood and other flammable materials away from the drive.</p>
Altitude	<p>1000 m (3281 ft.) maximum  <b>Note:</b>            Derate the output current by 1% for each 100 m (328 ft.) to install the drive in altitudes between 1000 m to 3000 m (3281 ft. to 9843 ft.).            It is not necessary to derate the rated voltage in these conditions:</p> <ul style="list-style-type: none"> <li>• Installing the drive at 2000 m (6562 ft.) or lower</li> <li>• Installing the drive between 2000 m to 3000 m (6562 ft. to 9843 ft.) and grounding the neutral point on the power supply.              Contact Yaskawa or your nearest sales representative when not grounding the neutral point.</li> </ul>
Vibration	<ul style="list-style-type: none"> <li>• 10 Hz to 20 Hz: 1 G (9.8 m/s<sup>2</sup>, 32.15 ft/s<sup>2</sup>)</li> <li>• 20 Hz to 55 Hz:              Models 2004 to 2211, 4002 to 4168: 0.6 G (5.9 m/s<sup>2</sup>, 19.36 ft/s<sup>2</sup>)              Models 2257 to 2415, 4208 to 4675: 0.2 G (2.0 m/s<sup>2</sup>, 6.56 ft/s<sup>2</sup>)</li> </ul>
Installation Position	Install the drive vertically for sufficient cooling airflow.

**NOTICE:** Do not put drive peripheral devices, transformers, or other electronics near the drive. Shield the drive from electrical interference if components must be near the drive. Failure to obey can cause incorrect operation.

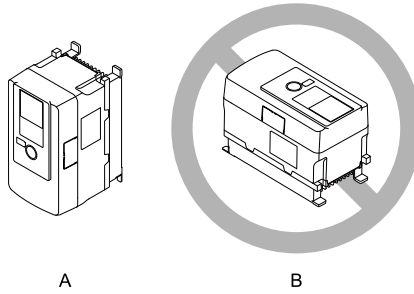
**NOTICE:** Do not let unwanted objects, for example metal shavings or wire clippings, fall into the drive during drive installation and project construction. Put a temporary cover over the top of the drive during installation. Remove the temporary cover before start-up or the drive will overheat. Failure to obey can cause damage to the drive.

## 2.3 Installation Position and Distance

Install the drive vertically for sufficient cooling airflow.

**Note:**

Contact Yaskawa or a Yaskawa representative for more information about installing drive models on their side.



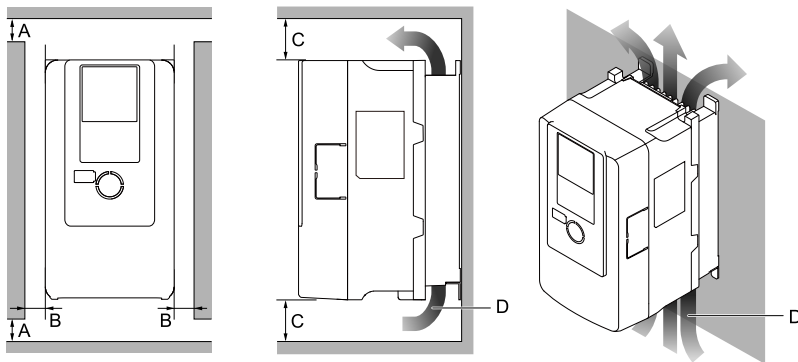
**A - Vertical installation**

**B - Horizontal installation**

**Figure 2.1 Installation Position**

### ◆ Single Drive Installation

Use the clearances specified in [Figure 2.2](#) to install the drive. Make sure that there is sufficient space for wiring and airflow.



**A - 50 mm (2 in.) minimum**  
**B - 30 mm (1.2 in.) minimum on both sides**

**C - 120 mm (4.7 in.) minimum above and below**  
**D - Airflow direction**

**Figure 2.2 Installation Distances for One Drive**

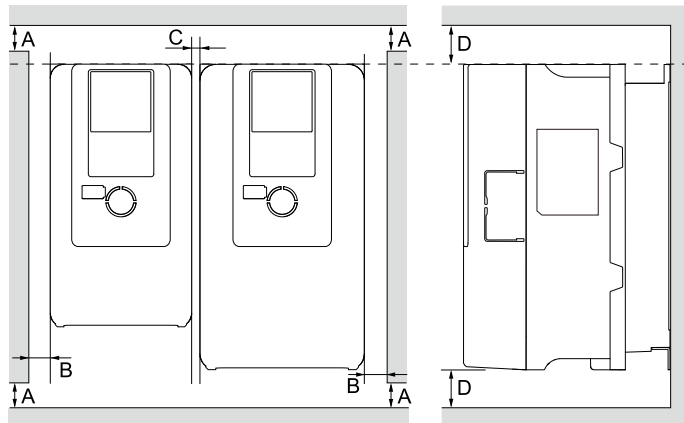
### ◆ Install Drives Side-by-Side

Users can install drive models 2004xB to 2082xB and 4002xB to 4044xB side-by-side.

Install the drives as specified by [Figure 2.3](#). Set  $L8-35 = 1$  [*Installation Method Selection = Side-by-Side Mounting*].

Derate the output current to align with the ambient temperature.

Install other drive models as specified by [Figure 2.2](#)



**A - 50 mm (2 in.) minimum**

**B - 30 mm (1.2 in.) minimum on both sides**

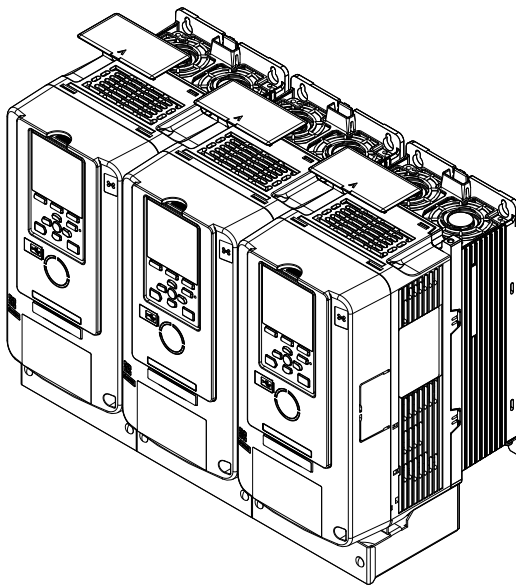
**C - 2 mm (0.08 in.) minimum between each drive**

**D - 120 mm (4.7 in.) minimum above and below**

**Figure 2.3 Installation Distances for Multiple Drives (Side-by-Side)**

**Note:**

- Align the tops of drives that have different dimensions to help when replacing cooling fans.
- Remove the top protective covers of all drives when mounting UL Type 1 enclosure drives side-by-side.



**Figure 2.4 Enclosed Wall-Mounted Type (UL Type 1) Installed Side-by-Side**

## 2.4 Moving the Drive

Obey local laws and regulations when moving and installing this product.

**CAUTION!** *Crush Hazard. Do not hold the drive by the front cover or terminal cover. Tighten the screws correctly before moving the drive. Failure to obey can cause minor to moderate injury.*

Drive Weight	Persons Necessary to Move the Drive
< 15 kg (33 lbs.)	1
≥ 15 kg (33 lbs.)	2 + using appropriate lifting equipment

Refer to [Using the Hanging Brackets to Move the Drive on page 38](#) for information about moving the drive with suspension systems, wires, or hanging metal brackets.

### ◆ Using the Hanging Brackets to Move the Drive

Use the hanging brackets attached to the drive to temporarily lift the drive when you install the drive to a control panel or wall or when you replace the drive. Do not let the drive stay vertically or horizontally suspended or move the drive over a long distance while it is suspended.

Before you install the drive, make sure that you read the these precautions:

**WARNING!** *Crush Hazard. Use screws to correctly attach the drive front cover, terminal blocks, and other drive components before hanging the drive vertically. Failure to obey can cause serious injury or death from falling equipment.*

**WARNING!** *Crush Hazard. Prevent more than 1.96 m/s<sup>2</sup> (0.2 G) vibration and impact to a hanging drive. Failure to obey can cause death or serious injury from falling equipment.*

**WARNING!** *Crush Hazard. Do not try to flip over a hanging drive or leave a hanging drive unattended. Failure to obey can cause death or serious injury from falling equipment.*

### ◆ Instructions on Drive Suspension

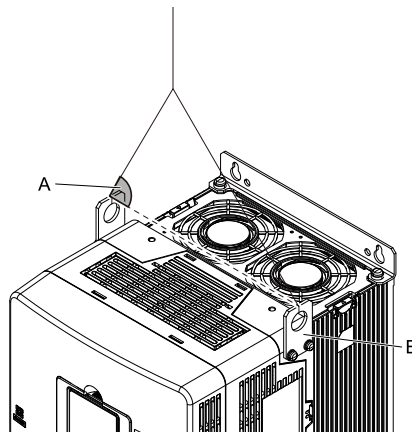
Use the procedures in this section to suspend the drive with wires.

Model	Suspension Method
2110 to 2211, 4075 to 4168	Vertical Suspension
2257 to 2415, 4208 to 4675	Horizontal Suspension

### ■ Vertical Suspension

To vertically suspend the drive with the hanging brackets, lift the drive with this procedure:

1. Put wire through the 2 holes in the hanging brackets.



A - Suspension angle of at least 50 degrees

B - Hanging bracket (2)

Figure 2.5 Vertical Suspension

2. Use a crane to gradually wind up the wire. Visually make sure that there is sufficient tension in the wire, then lift the drive to its correct location. 3. Prepare the control panel for installation, then lower the drive.

3. Prepare the control panel for installation, then lower the drive.

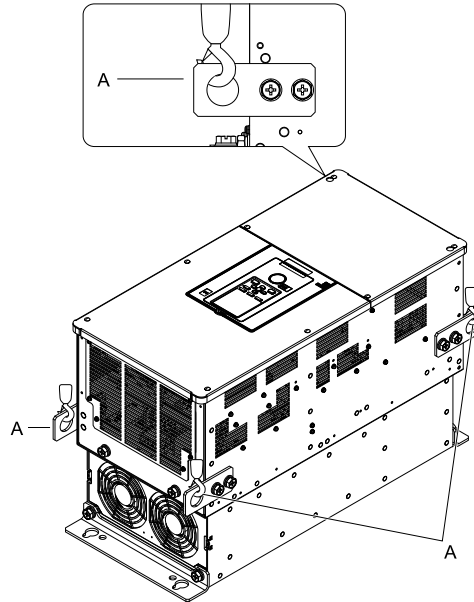
**Note:**

When lowering the drive, stop before the drive touches the floor, then slowly lower it the remaining distance.

**■ Horizontal Suspension**

Put the drive on the ground horizontally. Connect wires to the 4 hanging brackets and use a crane to lift the drive.

**NOTICE:** If you attach a horizontal wire to the drive, the wire can scratch and damage the drive if touches the drive. Use a jig or pad to prevent damage to the drive.



A - Hanging bracket (4)

Figure 2.6 Horizontal Suspension

## 2.5 Drive Watt Loss

### ◆ 200 V Class

Table 2.1 Drive Watt Loss (Heavy Duty)

Model	Rated Output Current A	Carrier Frequency kHz	Interior Unit Loss W	Cooling Fin Loss W	Total Loss W
2004	3.2	8	35	18	53
2006	5	8	37	26	63
2010	8	8	44	43	87
2012	11	8	50	61	111
2018	14	8	47	82	129
2021	17.5	8	56	105	161
2030	25	8	74	174	248
2042	33	8	88	183	271
2056	47	8	112	267	379
2070	60	8	145	373	518
2082	75	8	179	478	657
2110	88	8	155	563	718
2138	115	8	212	680	892
2169	145	5	275	820	1095
2211	180	5	314	991	1305
2257	215	5	398	1252	1650
2313	283	5	502	1643	2145
2360	346	5	582	1978	2560
2415	415	5	644	2359	3003

Table 2.2 Drive Watt Loss (Normal Duty)

Model	Rated Output Current A	Carrier Frequency kHz	Interior Unit Loss W	Cooling Fin Loss W	Total Loss W
2004	3.5	2	35	16	51
2006	6	2	38	25	63
2010	9.6	2	49	46	95
2012	12.2	2	56	62	118
2018	17.5	2	53	88	141
2021	21	2	75	125	200
2030	30	2	95	206	301
2042	42	2	129	227	356
2056	56	2	149	302	451
2070	70	2	177	403	580
2082	82	2	202	467	669
2110	110	2	192	631	823
2138	138	2	269	814	1083
2169	169	2	338	941	1279
2211	211	2	384	1131	1515



Model	Rated Output Current A	Carrier Frequency kHz	Interior Unit Loss W	Cooling Fin Loss W	Total Loss W
2257	257	2	519	1534	2053
2313	313	2	579	1794	2373
2360	360	2	655	2071	2726
2415	-	-	-	-	-

## ◆ 400 V Class

Table 2.3 Drive Watt Loss (Heavy Duty: < 460 V)

Model	Rated Output Current A	Carrier Frequency kHz	Interior Unit Loss W	Cooling Fin Loss W	Total Loss W
4002	1.8	8	38	15	53
4004	3.4	8	42	28	70
4005	4.8	8	46	37	83
4007	5.5	8	48	45	93
4009	7.2	8	37	61	98
4012	9.2	8	46	82	128
4018	14.8	8	65	140	205
4023	18	8	73	150	223
4031	24	8	101	211	312
4038	31	8	119	272	391
4044	39	8	148	354	502
4060	45	8	126	389	515
4075	60	8	165	527	692
4089	75	8	184	617	801
4103	91	8	237	779	1016
4140	112	5	300	956	1256
4168	150	5	486	1274	1760
4208	180	5	446	1432	1878
4250	216	5	558	1464	2022
4296	260	5	692	2061	2753
4371	304	5	824	2346	3170
4389	371	5	777	2212	2989
4453	414	2	963	2696	3659
4568	453	2	1086	3035	4121
4675	605	2	1328	3995	5323

Table 2.4 Drive Watt Loss (Heavy Duty: ≥ 460 V)

Model	Rated Output Current A	Carrier Frequency kHz	Interior Unit Loss W	Cooling Fin Loss W	Total Loss W
4002	1.6	8	38	15	53
4004	2.1	8	39	19	58
4005	3.4	8	43	30	73
4007	4.8	8	46	43	89

## 2.5 Drive Watt Loss

Model	Rated Output Current A	Carrier Frequency kHz	Interior Unit Loss W	Cooling Fin Loss W	Total Loss W
4009	6.9	8	35	63	98
4012	7.6	8	39	71	110
4018	11	8	53	110	163
4023	14	8	59	120	179
4031	21	8	85	192	277
4038	27	8	99	245	344
4044	34	8	124	320	444
4060	40	8	115	361	476
4075	52	8	147	477	624
4089	65	8	165	566	731
4103	77	8	206	700	906
4140	96	5	265	849	1114
4168	124	5	400	1073	1473
4208	156	5	405	1300	1705
4250	180	5	454	1174	1628
4296	240	5	664	2021	2685
4371	302	5	843	2499	3342
4389	361	5	745	2161	2906
4453	414	2	1024	2835	3859
4568	477	2	1183	3329	4512
4675	-	-	-	-	-

Table 2.5 Drive Watt Loss (Normal Duty: < 460 V)

Model	Rated Output Current A	Carrier Frequency kHz	Interior Unit Loss W	Cooling Fin Loss W	Total Loss W
4002	2.1	2	39	16	55
4004	4.1	2	44	33	77
4005	5.4	2	48	31	79
4007	7.1	2	52	44	96
4009	8.9	2	42	58	100
4012	11.9	2	57	84	141
4018	17.5	2	82	144	226
4023	23.4	2	108	185	293
4031	31	2	138	222	360
4038	38	2	145	270	415
4044	44	2	168	335	503
4060	59.6	2	157	444	601
4075	74.9	2	185	527	712
4089	89.2	2	212	665	877
4103	103	2	264	766	1030
4140	140	2	393	1126	1519
4168	168	2	574	1348	1922
4208	208	2	493	1465	1958

Model	Rated Output Current A	Carrier Frequency kHz	Interior Unit Loss W	Cooling Fin Loss W	Total Loss W
4250	250	2	686	1738	2424
4296	296	2	805	2155	2960
4371	371	2	1022	2553	3575
4389	389	2	867	2393	3260
4453	453	2	1086	3035	4121
4568	568	2	1429	3989	5418
4675	675	2	1526	4572	6098

Table 2.6 Drive Watt Loss (Normal Duty:  $\geq 460$  V)

Model	Rated Output Current A	Carrier Frequency kHz	Interior Unit Loss W	Cooling Fin Loss W	Total Loss W
4002	2.1	2	39	16	55
4004	3	2	42	25	67
4005	4.8	2	45	28	73
4007	6.9	2	50	42	92
4009	7.6	2	35	49	84
4012	11	2	49	76	125
4018	14	2	64	112	176
4023	21	2	87	158	245
4031	27	2	109	188	297
4038	34	2	116	234	350
4044	40	2	137	296	433
4060	52	2	133	379	512
4075	65	2	156	450	606
4089	77	2	180	569	749
4103	96	2	229	698	927
4140	124	2	334	982	1316
4168	156	2	481	1199	1680
4208	180	2	429	1275	1704
4250	240	2	648	1643	2291
4296	302	2	817	2257	3074
4371	361	2	975	2561	3536
4389	414	2	873	2422	3295
4453	477	2	1183	3329	4512
4568	515	2	1320	3697	5017
4675	-	-	-	-	-

## 2.6 Remove and Reattach the Keypad

**NOTICE:** You must remove the keypad before you remove or reattach the front cover. Before you reattach the keypad, make sure that you tightly fasten the front cover back into its position. If you keep the keypad connected to the drive when you remove the front cover, it can cause an unsatisfactory connection and incorrect operation.

### ◆ Remove the Keypad

1. Push down the tab on the top of the keypad, then pull the keypad forward and remove it from the drive.

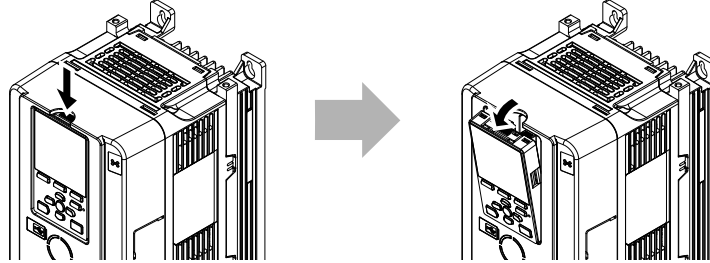
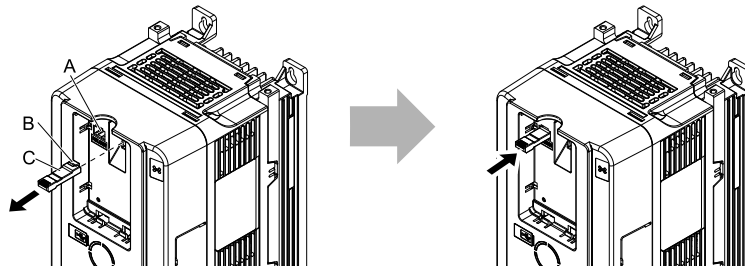


Figure 2.7 Remove the Keypad

2. Pull the keypad connector out from the drive horizontally, then put it in the holder.

**Note:**

Insert the end of the keypad connector that has the tab.



A - Holder  
B - Hook

C - Keypad connector

Figure 2.8 Move the Keypad Connector to the Holder

### ◆ Reattach the Keypad

Insert the keypad connector to its initial position. Put the bottom of the keypad into position first, then carefully push on the top of the keypad until the hook clicks into place.

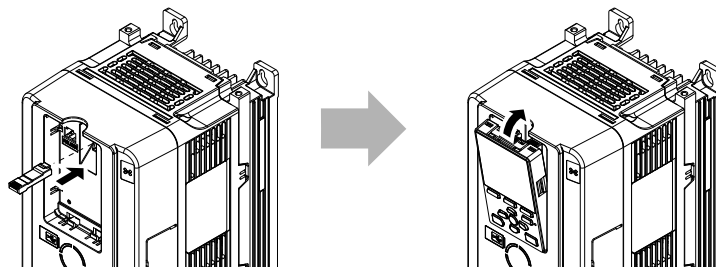


Figure 2.9 Reattach the Keypad

## 2.7 Install the Keypad to a Control Panel or Another Device

### ◆ Operate the Keypad Apart from the Drive

You can remove the keypad from the drive and connect it to a remote control extension cable 3 m (9.8 ft) long to make operation easier when you cannot access the drive. You can operate a drive that is in a control panel without opening or closing the control panel door. To order optional accessories, contact Yaskawa or your nearest sales representative.

### ◆ Connect the Keypad from a Remote Location

Use the information in [Table 2.7](#) to install the keypad in the best location for your application.

**Table 2.7 Keypad Installation Method**

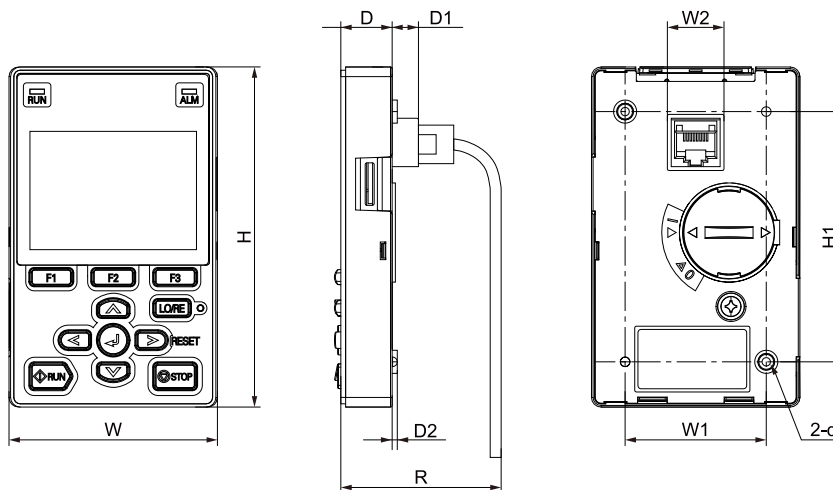
Installation Method	Description	Required Tools and Installation Support Sets
Outside the control panel	Simplified installation is possible. Separately sold installation support sets are not necessary.	Phillips screwdriver #2 (M3)
Inside the control panel	Keypad does not extend farther than the front of the control panel.	<ul style="list-style-type: none"> <li>Phillips screwdriver #2 (M3, M4)</li> <li>Installation support set A (for mounting with screws, model: 900-192-933-001)</li> </ul>
		<ul style="list-style-type: none"> <li>Phillips screwdriver #2 (M3)</li> <li>Wrench (M4)</li> <li>Installation support set B (for mounting with nut clamp, model: 900-192-933-002)</li> </ul>

#### Note:

Installation support sets are sold separately. If there are weld studs inside the control panel, use installation support set B.

**NOTICE:** Do not let unwanted objects, for example metal shavings or wire clippings, fall into the drive during drive installation and project construction. Put a temporary cover over the top of the drive during installation. Remove the temporary cover before start-up or the drive will overheat. Failure to obey can cause damage to the drive.

### ■ External Dimensions of Keypad



**Figure 2.10 Exterior and Mounting Dimensions**

**Table 2.8 Exterior Dimensions (mm)**

W	H	D	D1	D2	R *1	W1	W2	H1	d
65	106	16	8.2	1.6	53.8	44	15	78	M3

\*1 Minimum bending radius

■ Install Outside of Control Panel

1. Use the panel cut-out dimensions in Figure 2.11 and Table 2.9 to cut an opening in the control panel for the keypad.

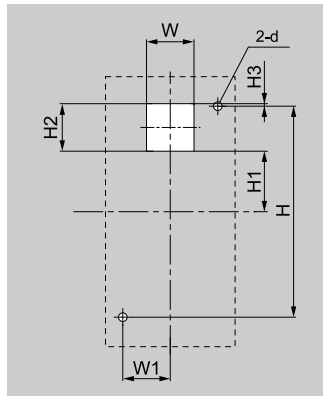


Figure 2.11 Panel Cut-Out Dimensions to Attach Outside of Control Panel

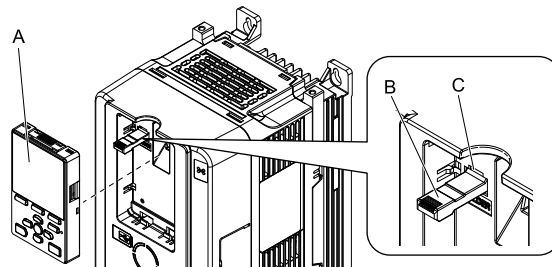
Table 2.9 Panel Cut-out Dimensions mm (in.)

W	H	W1	H1	H2	H3	d
22 (0.89)	78 (3.07)	22 (0.89)	29 (1.14)	22 (0.89)	1 (0.04)	3.6 (0.14)

2. Remove the keypad and put the keypad connector in the holder on the front cover.

**Note:**

Insert the end of the keypad connector that has the tab.



A - Keypad

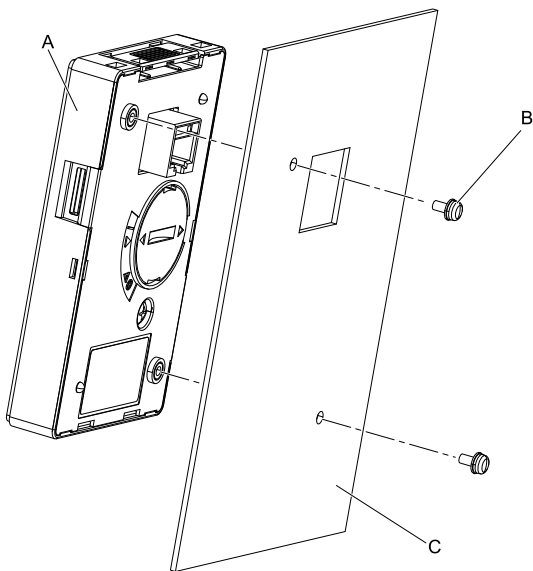
B - Keypad connector

C - Holder

Figure 2.12 Remove the Keypad

3. Put the keypad on the outside of the control panel.

Use M3 screws (6 mm (0.2 in.) depth cross-recessed pan head screws) to attach the keypad from the inside. Tighten the screws to a tightening torque of 0.49 N·m to 0.73 N·m (4.34 lb·in. to 6.46 lb·in.).

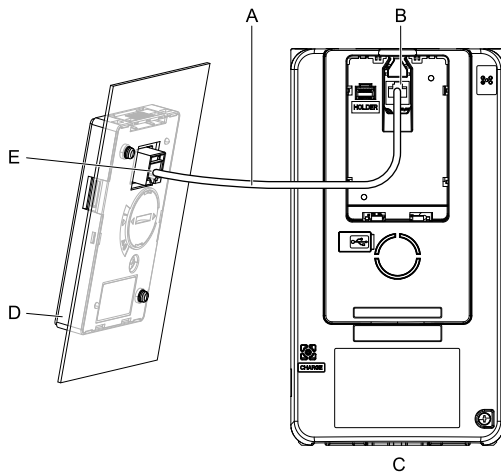


A - Keypad  
B - M3 screws

C - Control panel

**Figure 2.13 Mount to the Outside of Control Panel**

4. Use the remote control extension cable to connect the keypad to the drive.



A - Remote control extension  
B - Communications connector  
C - Drive

D - Keypad  
E - Cable connector

**Figure 2.14 Connect the Drive and Keypad with the Remote Control Extension Cable**

**■ Install Inside Control Panel**

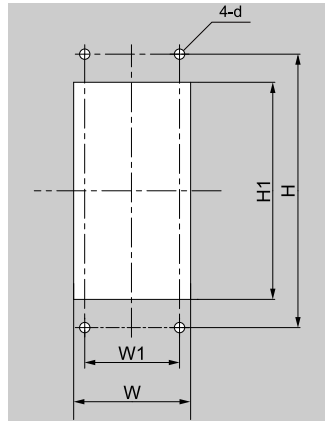
To attach the keypad inside of the control panel, you must purchase the installation support set, which is sold separately. Contact Yaskawa or your nearest sales representative to order mounting brackets and mounting hardware.

**Note:**

- The installation procedure and panel cut-out dimensions are the same for mounting brackets A and B.
- Use a gasket between the control panel and the keypad in environments with a large quantity of dust or other unwanted airborne material.

## 2.7 Install the Keypad to a Control Panel or Another Device

1. Use the panel cut-out dimensions in [Figure 2.15](#) and [Table 2.10](#) to cut an opening in the control panel for the keypad.



**Figure 2.15 Panel Cut-Out Dimensions to Attach Inside Control Panel**

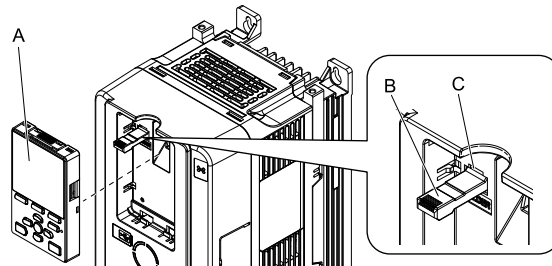
**Table 2.10 Panel Cut-out Dimensions mm (in.)**

W	H	W1	H1	d
64 + 0.5 (2.52 + 0.02)	130 (5.12)	45 (1.77)	105 + 0.5 (4.13 + 0.02)	4.8 (0.12)

2. Remove the keypad and put the keypad connector in the holder on the front cover.

**Note:**

Insert the end of the keypad connector that has the tab.

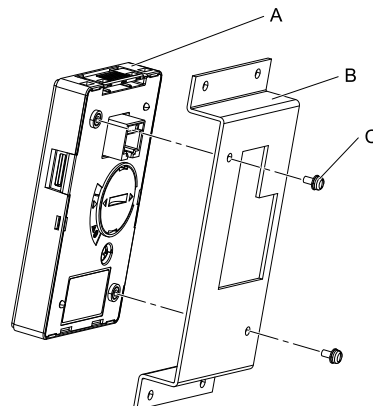


**A - Keypad**  
**B - Keypad connector**

**C - Holder**

**Figure 2.16 Remove the Keypad**

3. Use the screws supplied with the mounting bracket, and attach the keypad to the mounting bracket. Tighten the screws to a tightening torque of 0.49 to 0.73 N·m (4.34 to 6.46 lb·in.).



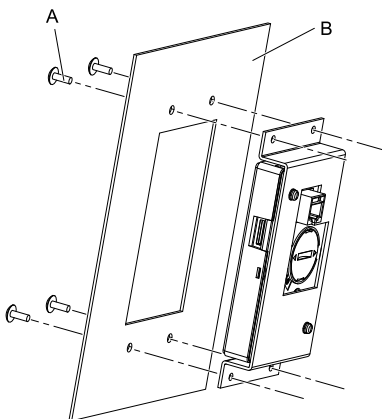
**A - Keypad**  
**B - Mounting bracket A**

**C - M3 screws**

**Figure 2.17 Attach Keypad to Mounting Bracket**



4. Position the mounting bracket to which the keypad has been attached in the control panel, and mount it from the outside using the screws.  
Use the screws supplied with the installation support set, and tighten them to a tightening torque of 0.98 to 1.33 N·m (8.67 to 11.77 lb·in.).

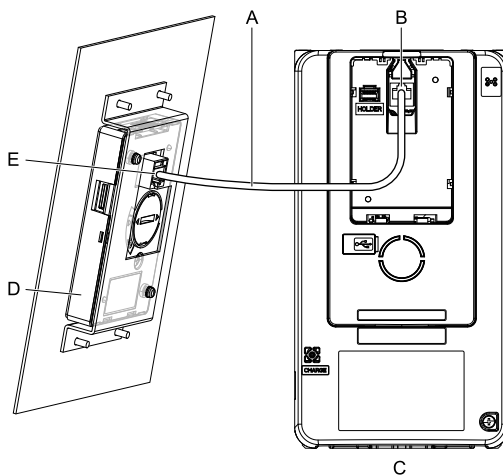


A - M4 screws

B - Control panel

Figure 2.18 Mount Mounting Bracket to the Interior of the Control Panel

5. Connect the keypad with the drive using the remote control extension cable.



A - Remote control extension

B - Communications connector

C - Drive

D - Keypad

E - Cable connector

Figure 2.19 Connect the Drive and Keypad with the Remote Control Extension Cable

## 2.8 Removing/Reattaching Covers

This section gives information about how to remove and reattach the front cover and terminal cover for wiring and inspection.

Different drive models have different procedures to remove and reattach the covers. Refer to [Table 2.11](#) for more information.

**Table 2.11 Procedures to Remove Covers by Drive Model**

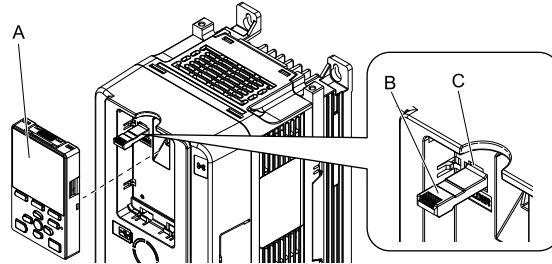
Model	Procedure	Reference
2004 - 2211 4002 - 4168	Procedure A	50
2257 - 2415 4208 - 4675	Procedure B	51

### ◆ Removing/Reattaching the Cover Using Procedure A

**DANGER! Electrical Shock Hazard.** Do not examine, connect, or disconnect wiring on an energized drive. Before servicing, disconnect all power to the equipment and wait for the time specified on the warning label at a minimum. The internal capacitor stays charged after the drive is de-energized. The charge indicator LED extinguishes when the DC bus voltage decreases below 50 Vdc. When all indicators are OFF, remove the covers before measuring for dangerous voltages to make sure that the drive is safe. Failure to obey will cause death or serious injury.

#### ■ Remove the Front Cover

1. Remove the keypad and remove the keypad connector, then insert the end of the keypad connector that has the tab into the keypad connector holder on the front cover.

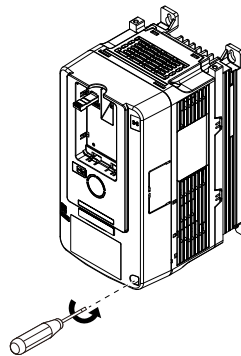


A - Keypad  
B - Keypad connector

C - Holder

**Figure 2.20 Remove the Keypad and Keypad Connector**

2. Loosen the front cover screw.



**Figure 2.21 Loosen the Front Cover Screw**

3. Push on the tab in the side of the front cover then pull the front cover forward to remove it from the drive.

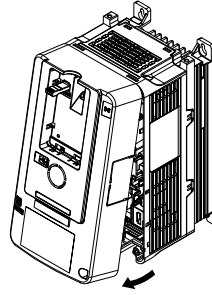


Figure 2.22 Remove the Front Cover

### ■ Reattach the Front Cover

1. Wire the drive and other peripheral devices.
2. Reverse the steps to reattach the cover.

#### Note:

- Wire the grounding terminals first, main circuit terminals next, and control circuit terminals last.
- Make sure that you do not pinch wires or signal lines between the front cover and the drive before you reattach the cover.
- Tighten the screws to a tightening torque of 0.98 N·m to 1.33 N·m (8.67 lb·in. to 11.77 lb·in.).

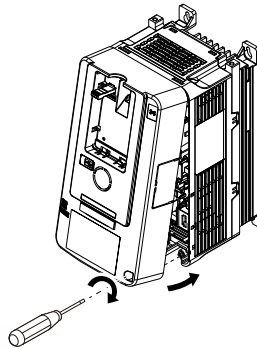


Figure 2.23 Reattach the Front Cover

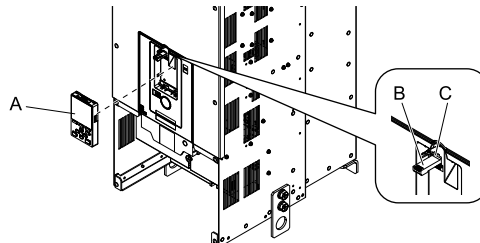
3. Reattach the keypad to the original position.

### ◆ Removing/Reattaching the Cover Using Procedure B

**DANGER! Electrical Shock Hazard.** Do not examine, connect, or disconnect wiring on an energized drive. Before servicing, disconnect all power to the equipment and wait for the time specified on the warning label at a minimum. The internal capacitor stays charged after the drive is de-energized. The charge indicator LED extinguishes when the DC bus voltage decreases below 50 Vdc. When all indicators are OFF, remove the covers before measuring for dangerous voltages to make sure that the drive is safe. Failure to obey will cause death or serious injury.

### ■ Remove the Front Cover

1. Remove the terminal cover, keypad, and keypad connector, then insert the end of the keypad connector that has the tab into the keypad connector holder on the front cover.



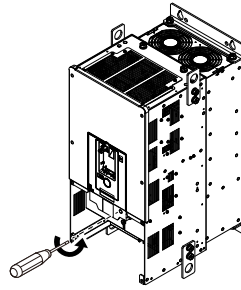
A - Keypad

B - Keypad connector

C - Connector holder

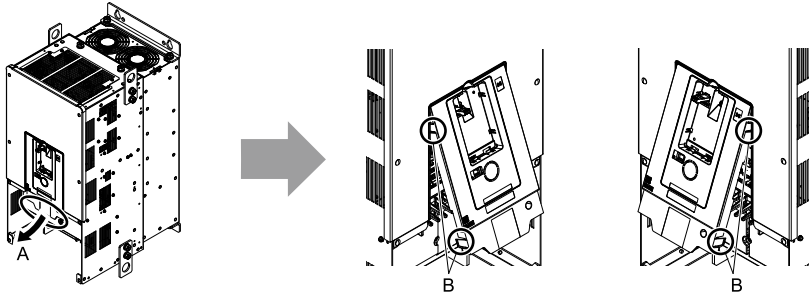
Figure 2.24 Remove the Terminal Cover, Keypad, and Keypad Connector

2. Loosen the front cover screws.



**Figure 2.25 Loosen the Front Cover Screws**

3. Push on the four tabs found on each side of the front cover, then pull the front cover forward to remove it from the drive.

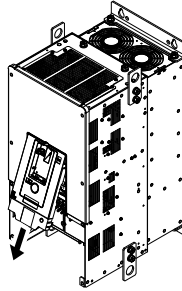


**A - Pull forward to remove the front cover.**

**B - Unhook the tabs found on the sides of the front cover.**

**Figure 2.26 Pull Forward to Remove the Front Cover**

4. Remove the front cover from the drive.



**Figure 2.27 Remove the Front Cover**

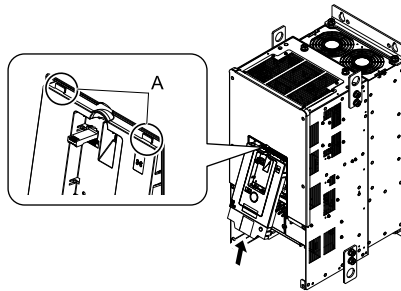
### ■ Reattach the Front Cover

Wire the drive and other peripheral devices then reattach the front cover.

**Note:**

Wire the grounding terminals first, main circuit terminals next, and control circuit terminals last.

1. Move the front cover to connect the hooks at the top of the front cover to the drive.



**A - Hooks**

**Figure 2.28 Reattach the Front Cover**

2. Move the front cover until it clicks into position while pushing on the hooks on the left and right sides of the front cover.

**Note:**

Make sure that you do not pinch wires or signal lines between the front cover and the drive before you reattach the cover.

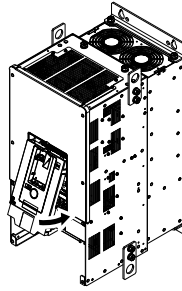


Figure 2.29 Reattach the Front Cover

3. Reattach the keypad to the original position.

### ■ Remove the Terminal Cover

1. Loosen the screws on the terminal cover, then pull down on the cover.

**CAUTION!** *Crush Hazard. Only loosen the cover screws. Do not fully remove the cover screws. Make sure that the terminal covers for larger drives do not fall. Missing cover screws can cause the terminal cover to fall and cause injury.*

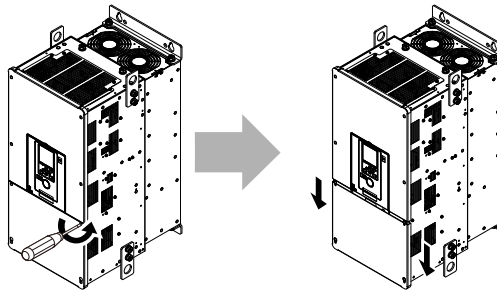


Figure 2.30 Loosen the Terminal Cover Mounting Screws

2. Pull the terminal cover away from the drive.

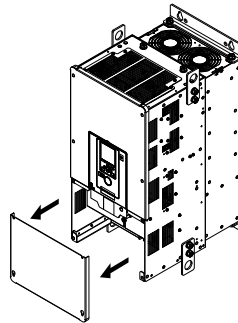


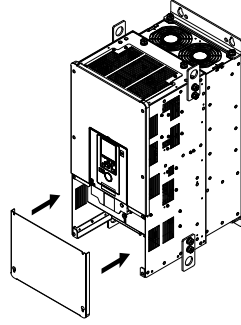
Figure 2.31 Remove the Terminal Cover

### ■ Reattach the Terminal Cover

Wire the drive and other peripheral devices then reattach the terminal cover.

**Note:**

- Wire the grounding terminals first, main circuit terminals next, and control circuit terminals last.
- Make sure that you do not pinch wires or signal lines between the wiring cover and the drive before you reattach the cover.
- Tighten the screws to a tightening torque of 0.98 N·m to 1.33 N·m (8.67 lb·in. to 11.77 lb·in.).



**Figure 2.32 Reattach the Terminal Cover**

## 2.9 Change the Drive Enclosure Type

The enclosure type of the drive is open chassis type (IP20). This section gives information about how to install UL Type 1 protective covers to change the enclosure type to an enclosed wall-mounted type (UL Type 1).

Install the protective covers before you wire the drive.

Different drive models have different procedures to install the protective covers. Refer to [Table 2.12](#) for more information.

**Table 2.12 Procedures to Install UL Type 1 Covers by Drive Model**

Model	Procedure	Reference
2004 - 2082 4002 - 4060	Procedure A	55
2110 4075	Procedure B	56
2138 4089 - 4103	Procedure C	58
2169 - 2211 4140 - 4168	Procedure D	61
2257 - 2313 4208 - 4296	Procedure E	63
2360 4371	Procedure F	65

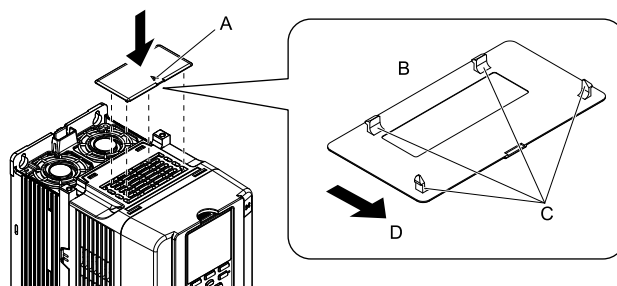
### ◆ Attach the Protective Cover (Procedure A)

#### ■ Attach the Top Protective Cover

Align the hooks on the rear of top protective cover with the holes on the top of the drive to attach the top protective cover.

**Note:**

- Attach the top protective cover and point the (A) mark on the upper surface of the top protective cover away from the front of the drive.
- Put the two small hooks on the rear of the top protective cover into the mounting holes near the back of the drive. Then push down on the front side of the top protective cover to attach the cover.



**A - Mark**

**B - Rear of top protective cover**

**C - Hooks**

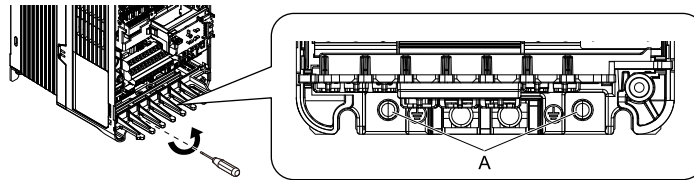
**D - Front of drive**

**Figure 2.33 Attach the Top Protective Cover**

#### ■ Attach the Conduit Bracket

Remove the front cover.

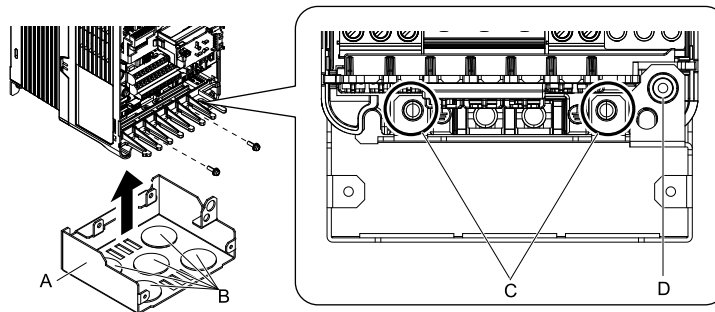
1. Remove the screws that attach the protective covers to the drive.



**A - Screws that attach the protective cover**

**Figure 2.34 Remove the Screws that Attach the Protective Cover**

2. Align the screw holes on conduit bracket 1 with the screw holes on the drive and push the bracket into position. Use the screws to attach it.

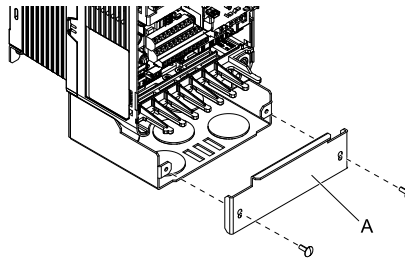


**A - Conduit bracket 1  
B - Wiring holes**

**C - Screw holes  
D - Screw hole**

**Figure 2.35 Attach Conduit Bracket 1**

3. Align the screw holes on conduit bracket 2 with the screw holes on conduit bracket 1. Tighten the screws to a tightening torque of 0.98 N·m to 1.33 N·m (8.67 lb·in. to 11.77 lb·in.).



**A - Conduit bracket 2**

**Figure 2.36 Attach Conduit Bracket 2**

4. Attach the front cover.

### ◆ Attach the Protective Cover (Procedure B)

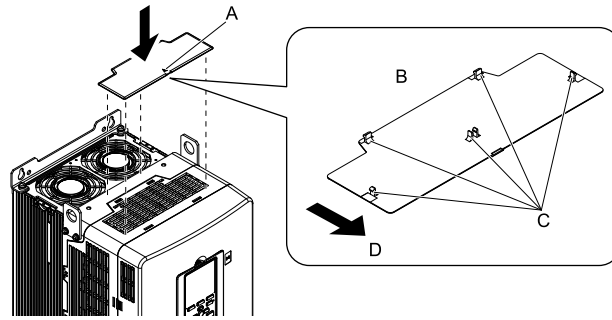
#### ■ Attach the Top Protective Cover

Align the hooks on the rear of top protective cover with the holes on the top of the drive to attach the top protective cover.

**Note:**

- Attach the top protective cover and point the (Λ) mark on the upper surface of the top protective cover away from the front of the drive.
- Put the two small hooks on the rear of the top protective cover into the mounting holes near the back of the drive. Then push down on the front side of the top protective cover to attach the cover.





A - Mark  
 B - Rear side of top protective cover  
 C - Hooks  
 D - Front of drive

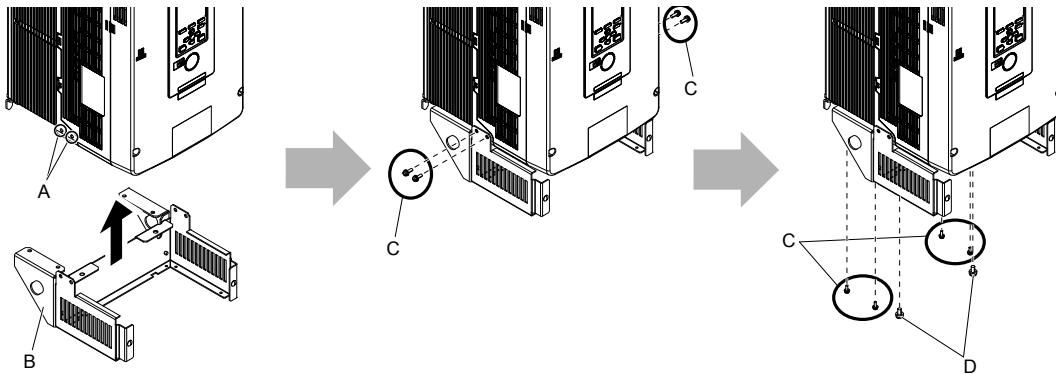
Figure 2.37 Attach the Top Protective Cover

■ Attach the Conduit Bracket

1. Align the screw holes on conduit bracket 1 with the screw holes on the drive and push the bracket into position. Use the screws to attach it at the sides and the bottom.

Tighten the screws to a correct tightening torque:

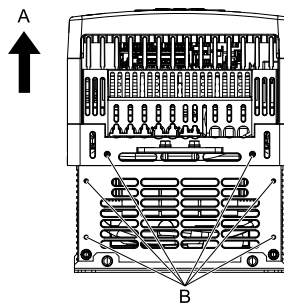
- Screw A: 1.96 to 2.53 N·m (17.35 to 22.39 lb·in.)
- Screw B: 0.98 to 1.33 N·m (8.67 to 11.77 lb·in.)



A - Screw holes on sides  
 B - Conduit bracket 1  
 C - Screws A  
 D - Screws B

Figure 2.38 Attach Conduit Bracket 1

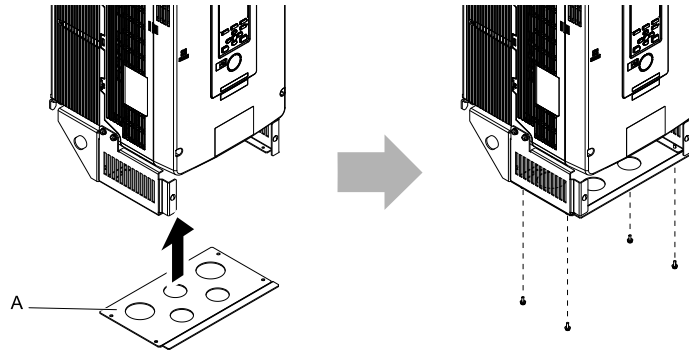
Figure 2.39 shows the locations of the screw holes on the bottom of the drive.



A - Front of drive  
 B - Screw holes on bottom

Figure 2.39 Locations of Screw Holes on Bottom

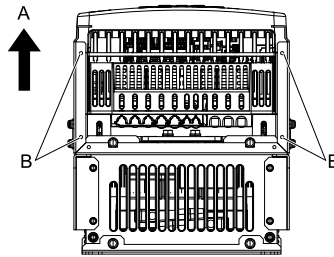
2. Align the screw holes on conduit bracket 2 with the screw holes on conduit bracket 1. Tighten the screws to a tightening torque of 0.98 N·m to 1.33 N·m (8.67 lb·in. to 11.77 lb·in.).



A - Conduit bracket 2

Figure 2.40 Attach Conduit Bracket 2

Figure 2.41 shows the locations of the screw holes on the bottom of conduit bracket 1.

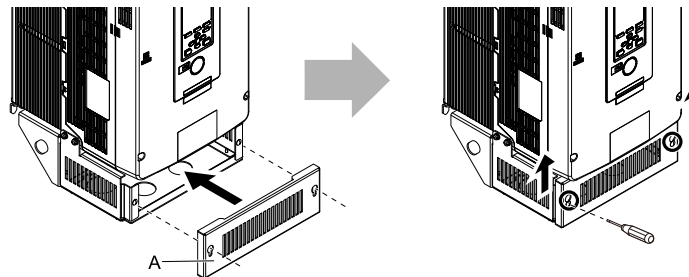


A - Front of drive

B - Screw holes on bottom

Figure 2.41 Locations of Screw Holes on Bottom of Conduit Bracket 1

3. Align the screw holes on conduit bracket 3 with the screw holes on conduit bracket 2. Tighten the screws to a tightening torque of 0.98 N·m to 1.33 N·m (8.67 lb·in. to 11.77 lb·in.) and lift bracket 3 a short distance.



A - Conduit bracket 3

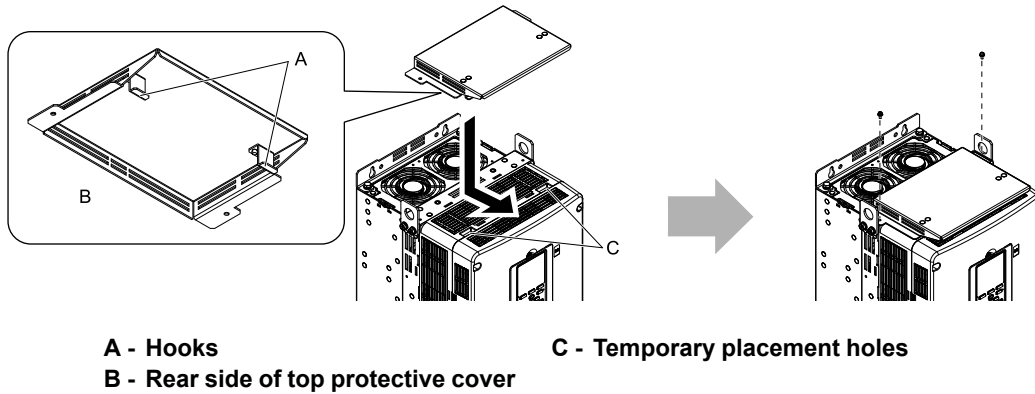
Figure 2.42 Attach Conduit Bracket 3

## ◆ Attach the Protective Cover (Procedure C)

### ■ Attach the Top Protective Cover

Put the hooks on the back of the top protective cover into the hook holes on the top of the drive.

Move the cover forward a short distance and tighten the screws to a tightening torque of 0.98 N·m to 1.33 N·m (8.67 lb·in. to 11.77 lb·in.) to attach the cover.

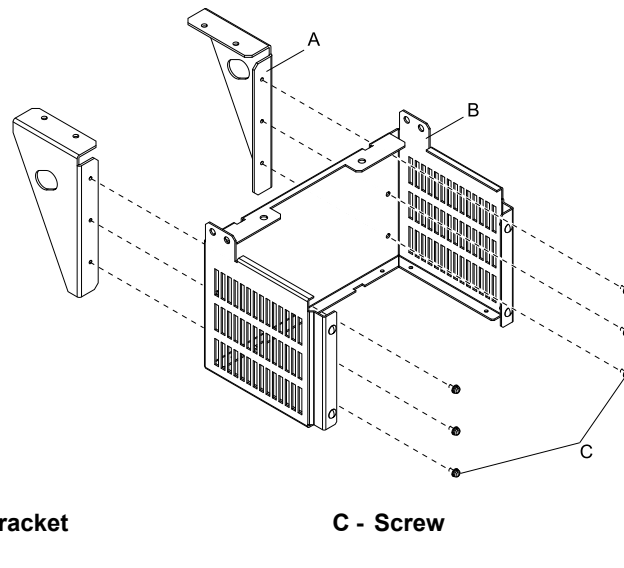


A - Hooks  
 B - Rear side of top protective cover  
 C - Temporary placement holes

Figure 2.43 Attach the Top Protective Cover

■ Attach the Conduit Bracket

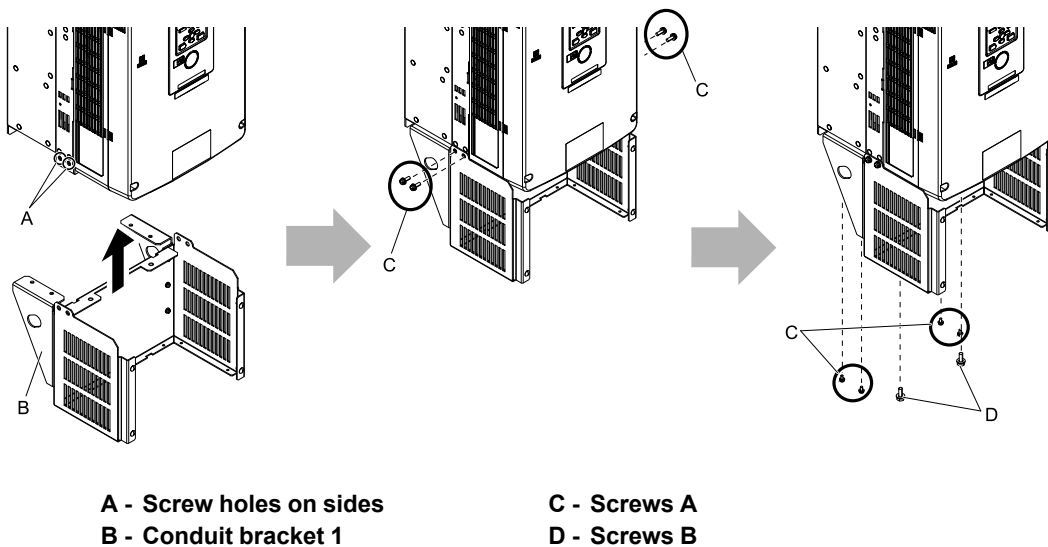
1. Align the screw holes on the stay bracket with the screw holes on the base. Tighten the included screws to a tightening torque of 0.98 N·m to 1.33 N·m (8.67 lb·in. to 11.77 lb·in.) to attach the stay bracket to the base.



A - Stay bracket  
 B - Base  
 C - Screw

Figure 2.44 Assemble Conduit Bracket 1

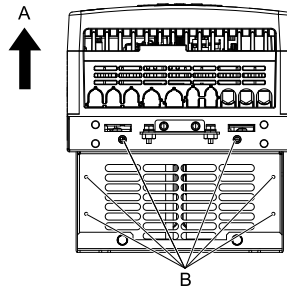
2. Align the screw holes on conduit bracket 1 with the screw holes on the drive. Tighten the included screws to a tightening torque of 3.92 N·m to 4.90 N·m (34.70 lb·in. to 43.37 lb·in.) to attach the bracket to the drive.



A - Screw holes on sides  
 B - Conduit bracket 1  
 C - Screws A  
 D - Screws B

Figure 2.45 Attach Conduit Bracket 1

Figure 2.46 shows the locations of the screw holes on the bottom of the drive.

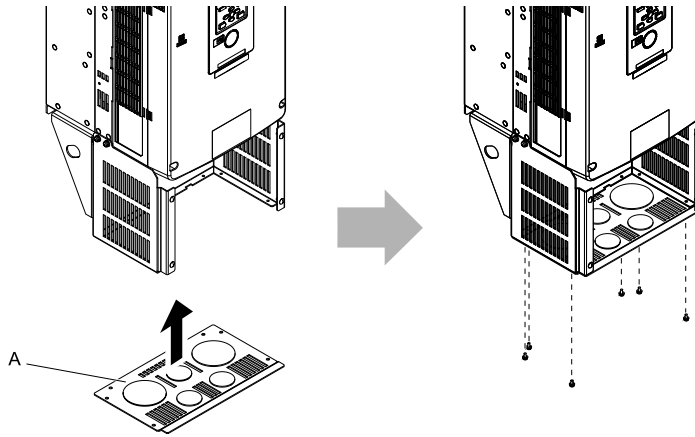


A - Front of drive

B - Screw holes on bottom

Figure 2.46 Locations of Screw Holes on Bottom

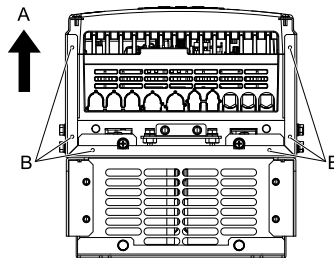
- Align the screw holes on conduit bracket 2 with the screw holes on conduit bracket 1. Tighten the screws to a tightening torque of 0.98 N·m to 1.33 N·m (8.67 lb·in. to 11.77 lb·in.).



A - Conduit bracket 2

Figure 2.47 Attach Conduit Bracket 2

Figure 2.48 shows the locations of the screw holes on the bottom of conduit bracket 1.

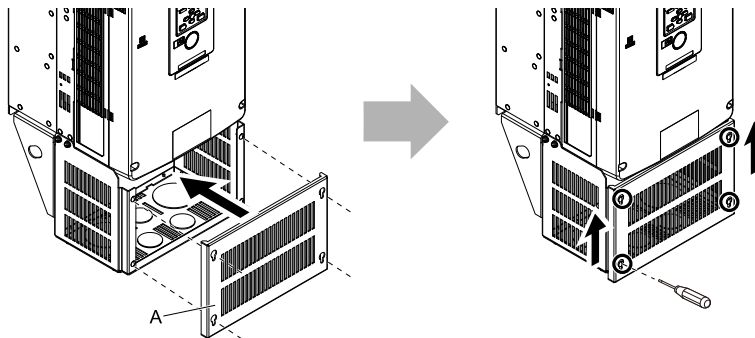


A - Front of drive

B - Screw holes on bottom

Figure 2.48 Locations of Screw Holes on Bottom of Conduit Bracket 1

- Align the screw holes on conduit bracket 3 with the screw holes on conduit bracket 2. Tighten the screws to a tightening torque of 0.98 N·m to 1.33 N·m (8.67 lb·in. to 11.77 lb·in.) and lift bracket 3 a short distance.



A - Conduit bracket 3

Figure 2.49 Attach Conduit Bracket 3

## ◆ Attach the Protective Cover (Procedure D)

### ■ Attach the Top Protective Cover

Put the hooks on the back of the top protective cover into the hook holes on the top of the drive.

Move the cover forward a short distance and tighten the screws to a tightening torque of 0.98 N·m to 1.33 N·m (8.67 lb·in. to 11.77 lb·in.) to attach the cover.

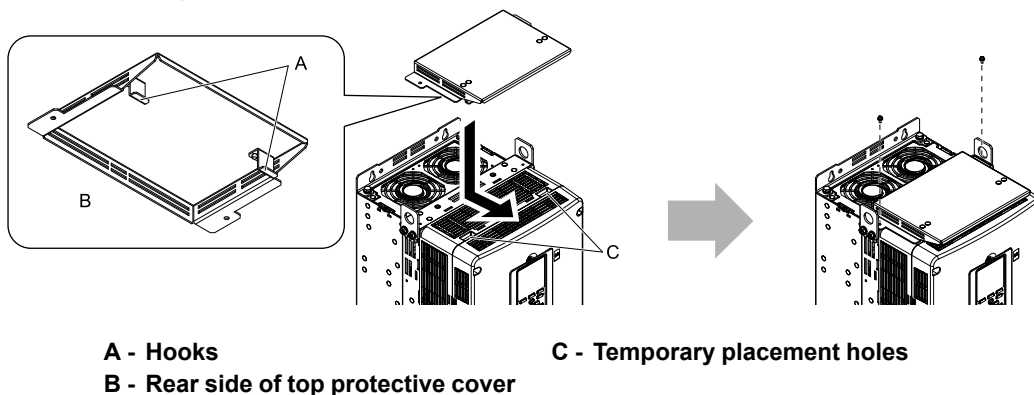


Figure 2.50 Attach the Top Protective Cover

### ■ Attach the Conduit Bracket

1. Align the screw holes on the stay bracket with the screw holes on the base. Tighten the included screws to a tightening torque of 0.98 N·m to 1.33 N·m (8.67 lb·in. to 11.77 lb·in.) to attach the stay bracket to the base.

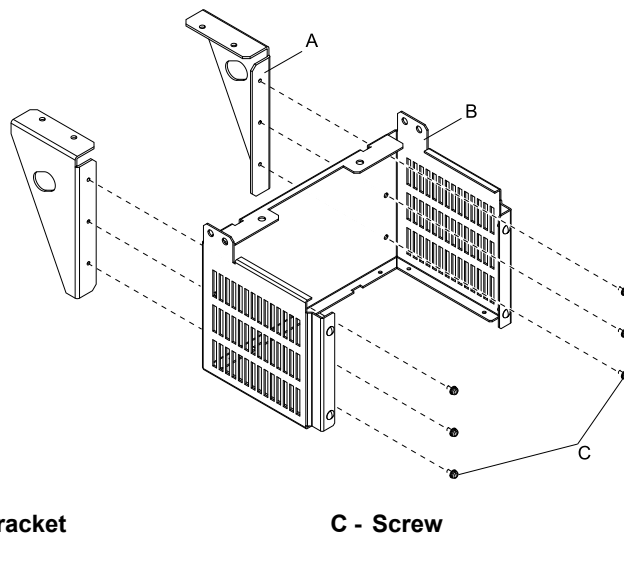
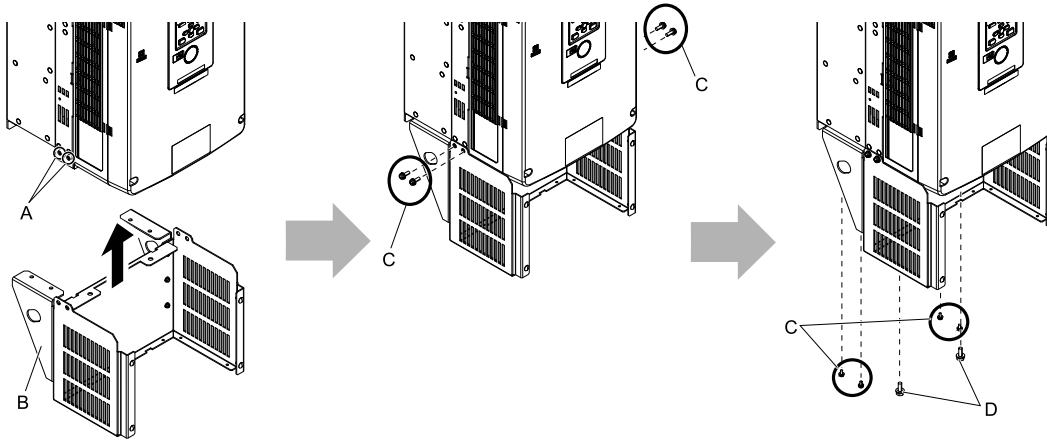


Figure 2.51 Assemble Conduit Bracket 1

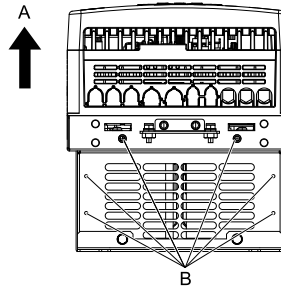
2. Align the screw holes on conduit bracket 1 with the screw holes on the drive and push the bracket into position. Use the screws to attach the bracket.  
Tighten the screws to a correct tightening torque.
  - Screw A: 3.92 N·m to 4.90 N·m (34.70 lb·in. to 43.37 lb·in.)
  - Screw B: 8.83 N·m to 10.79 N·m (78.15 lb·in. to 95.49 lb·in.)



**A - Screw holes on sides**                      **C - Screws A**  
**B - Conduit bracket 1**                        **D - Screws B**

**Figure 2.52 Attach Conduit Bracket 1**

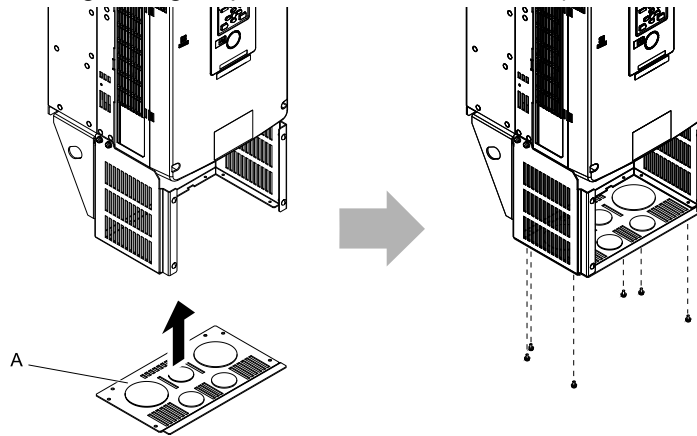
Figure 2.53 shows the locations of the screw holes on the bottom of the drive.



**A - Front of drive**                                      **B - Screw holes on bottom**

**Figure 2.53 Locations of Screw Holes on Bottom**

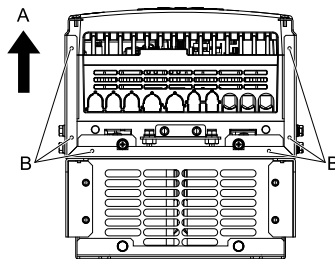
3. Align the screw holes on conduit bracket 2 with the screw holes on conduit bracket 1. Tighten the screws to a tightening torque of 0.98 N·m to 1.33 N·m (8.67 lb·in. to 11.77 lb·in.).



**A - Conduit bracket 2**

**Figure 2.54 Attach Conduit Bracket 2**

Figure 2.55 shows the locations of the screw holes on the bottom of conduit bracket 1.

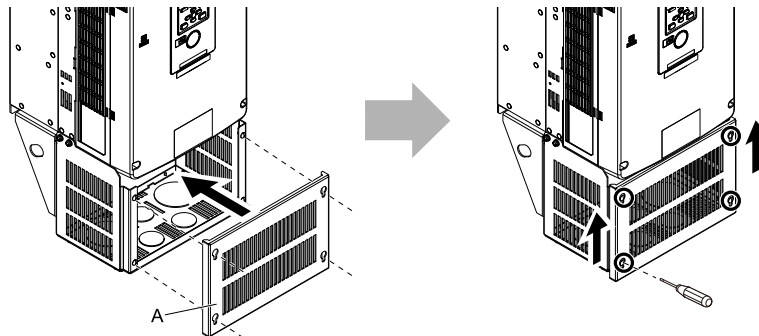


A - Front of drive

B - Screw holes on bottom

Figure 2.55 Locations of Screw Holes on Bottom of Conduit Bracket 1

4. Align the screw holes on conduit bracket 3 with the screw holes on conduit bracket 2. Tighten the screws to a tightening torque of 0.98 N·m to 1.33 N·m (8.67 lb·in. to 11.77 lb·in.) and lift bracket 3 a short distance.



A - Conduit bracket 3

Figure 2.56 Attach Conduit Bracket 3

## ◆ Attach the Protective Cover (Procedure E)

### ■ Attach the Top Protective Cover

Align the screw holes of the top protective cover with the screw holes on the top of the drive.

Tighten the screws to a tightening torque of 0.98 N·m to 1.33 N·m (8.67 lb·in. to 11.77 lb·in.) to attach the cover.

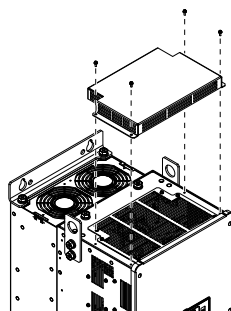
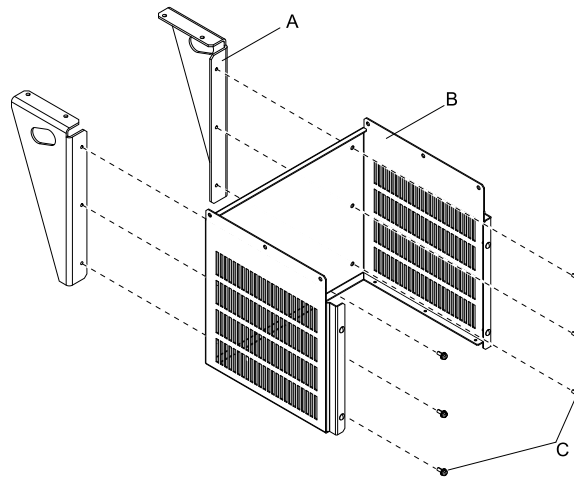


Figure 2.57 Attach the Top Protective Cover

■ **Attach the Conduit Bracket**

1. Align the screw holes on the stay bracket with the screw holes on the base. Tighten the included screws to a tightening torque of 0.98 N·m to 1.33 N·m (8.67 lb·in. to 11.77 lb·in.) to attach the stay bracket to the base.

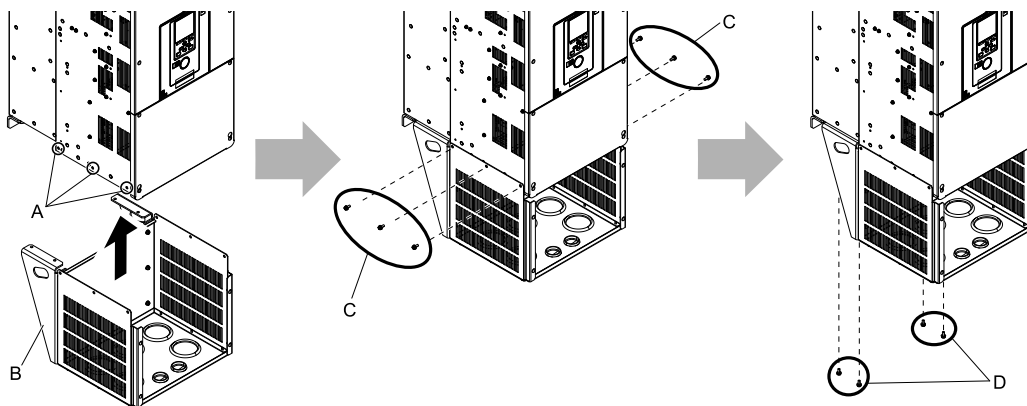


**A - Stay bracket**  
**B - Base**

**C - Screw**

**Figure 2.58 Assemble Conduit Bracket 1**

2. Align the screw holes on conduit bracket 1 with the screw holes on the drive and push the bracket into position.
  - Use the screws to attach the bracket.
  - Tighten the screws to a correct tightening torque:
    - Screw A: 0.98 N·m to 1.33 N·m (8.67 lb·in. to 11.77 lb·in.)
    - Screw B: 1.96 N·m to 2.53 N·m (17.35 lb·in. to 22.39 lb·in.)



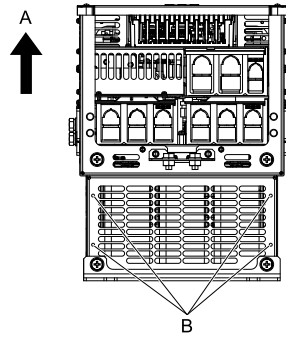
**A - Screw holes on sides**  
**B - Conduit bracket 1**

**C - Screws A**  
**D - Screws B**

**Figure 2.59 Attach Conduit Bracket 1**

Figure 2.60 shows the locations of the screw holes on the bottom of the drive.



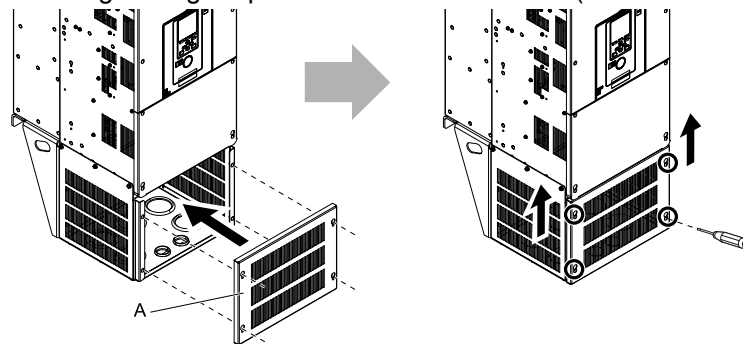


A - Front of drive

B - Screw holes on bottom

Figure 2.60 Locations of Screw Holes on Bottom

3. Align the screw holes on conduit bracket 2 with the screw holes on conduit bracket 1. Tighten the screws to a tightening torque of 0.98 N·m to 1.33 N·m (8.67 lb·in. to 11.77 lb·in.).



A - Conduit bracket 2

Figure 2.61 Attach Conduit Bracket 2

## ◆ Attach the Protective Cover (Procedure F)

### ■ Attach the Top Protective Cover

Align the screw holes of the top protective cover with the screw holes on the top of the drive.

Tighten the screws to a tightening torque of 0.98 N·m to 1.33 N·m (8.67 lb·in. to 11.77 lb·in.) to attach the cover.

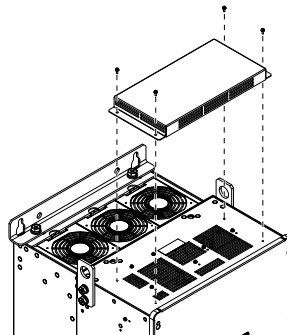
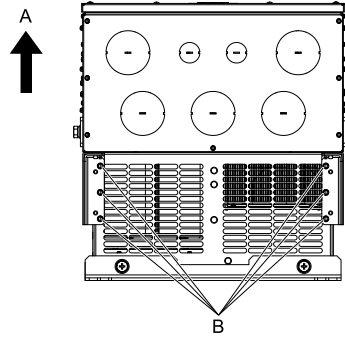


Figure 2.62 Attach the Top Protective Cover



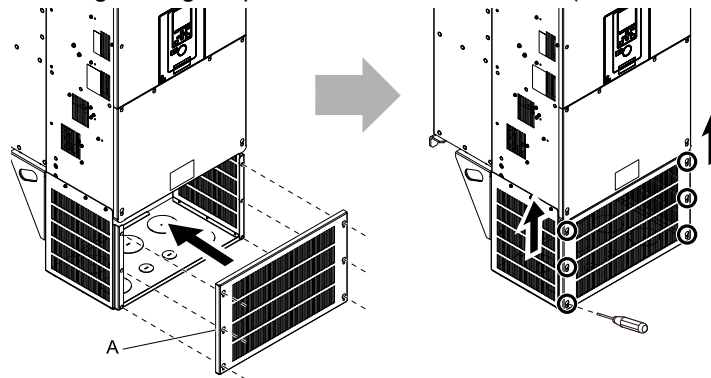


A - Front of drive

B - Screw holes on bottom

Figure 2.65 Locations of Screw Holes on Bottom

3. Align the screw holes on conduit bracket 2 with the screw holes on conduit bracket 1. Tighten the screws to a tightening torque of 0.98 N·m to 1.33 N·m (8.67 lb·in. to 11.77 lb·in.).



A - Conduit bracket 2

Figure 2.66 Attach Conduit Bracket 2

# 2.10 Installation Methods

The drive installation methods include standard installation and external heatsink installation.

---

### ◆ Standard Installation

Refer to *Drive Exterior and Mounting Dimensions on page 465* for more information about external dimensions and installation procedure.

---

### ◆ External Heatsink

Refer to [Table 2.13](#) and [Table 2.14](#) for the panel cut-out dimensions for external heatsink installations. An attachment is necessary to install drive models smaller than 2082 (200 V class) and 4060 (400 V class) with the heatsink outside of the panel.

**Note:**

- The exterior mounting dimensions and installation dimensions for a standard installation are different than the dimensions for an external heatsink installation.
- The shaded parts of the panel cut-out dimensions are the gasket dimensions. Make sure that the gasket is not smaller than the specified dimension.

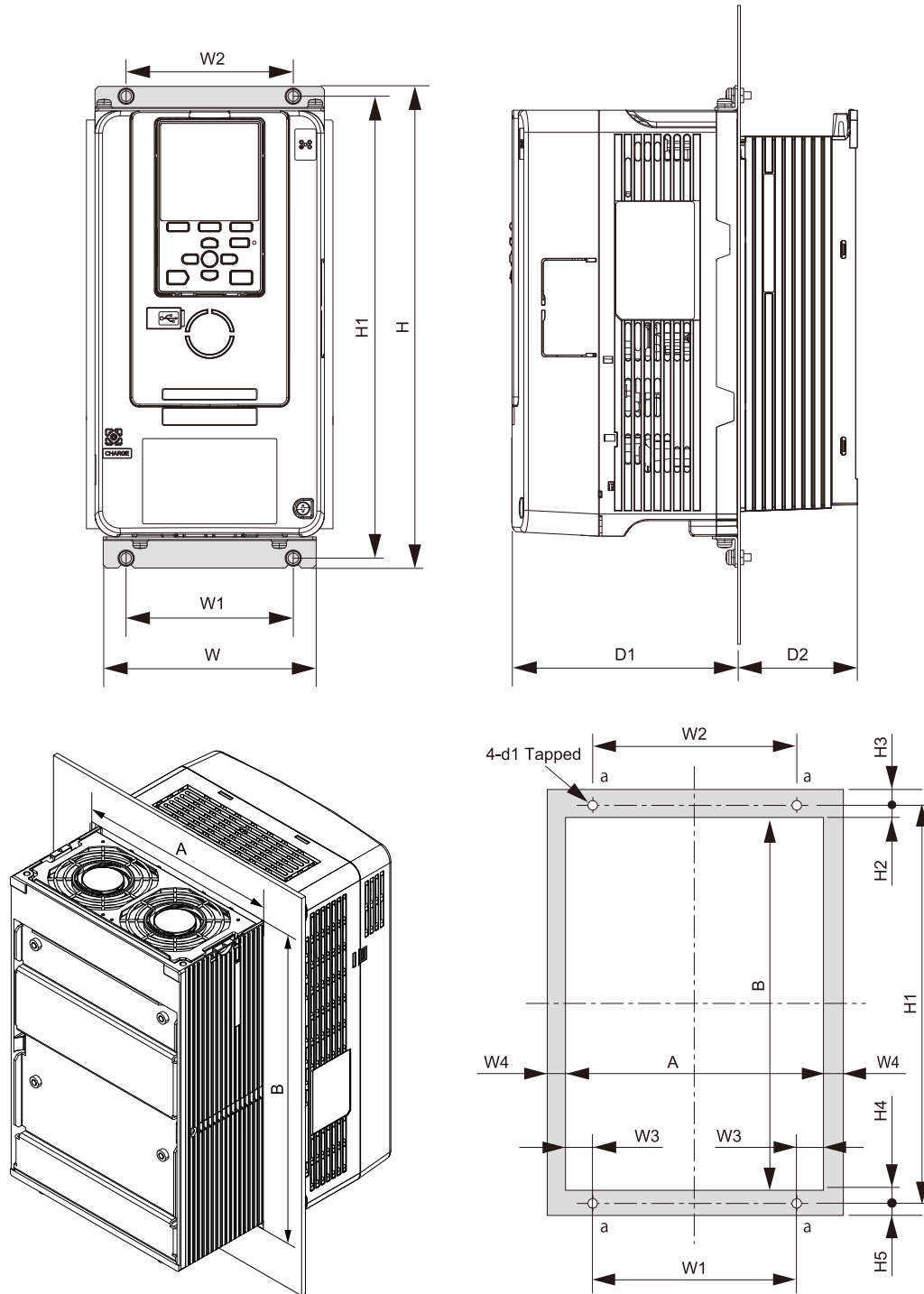


Figure 2.67 Panel Cut-Out Dimensions

Table 2.13 Panel Cut-Out Dimensions (200 V Class)

Model	Dimensions mm (in.)															
	W	H	D1	D2	W1	W2	W3	W4	H1	H2	H3	H4	H5	A	B	d1
2004 <i>*1</i>	140 (5.51)	294 (11.57)	138 (5.43)	38 (1.50)	102 (4.02)	102 (4.02)	16 (0.630)	3 (0.118)	282 (11.10)	23 (0.906)	6 (0.236)	26 (1.02)	6 (0.236)	134 (5.28)	233 (9.17)	M5
2006 <i>*1</i>	140 (5.51)	294 (11.57)	138 (5.43)	38 (1.50)	102 (4.02)	102 (4.02)	16 (0.630)	3 (0.118)	282 (11.10)	23 (0.906)	6 (0.236)	26 (1.02)	6 (0.236)	134 (5.28)	233 (9.17)	M5
2010 <i>*1</i>	140 (5.51)	294 (11.57)	138 (5.43)	38 (1.50)	102 (4.02)	102 (4.02)	16 (0.630)	3 (0.118)	282 (11.10)	23 (0.906)	6 (0.236)	26 (1.02)	6 (0.236)	134 (5.28)	233 (9.17)	M5

## 2.10 Installation Methods

Model	Dimensions mm (in.)															
	W	H	D1	D2	W1	W2	W3	W4	H1	H2	H3	H4	H5	A	B	d1
2012 <sup>*1</sup>	140 (5.51)	294 (11.57)	138 (5.43)	38 (1.50)	102 (4.02)	102 (4.02)	16 (0.630)	3 (0.118)	282 (11.10)	23 (0.906)	6 (0.236)	26 (1.02)	6 (0.236)	134 (5.28)	233 (9.17)	M5
2018 <sup>*1</sup>	140 (5.51)	294 (11.57)	138 (5.43)	73 (2.87)	102 (4.02)	102 (4.02)	16 (0.630)	3 (0.118)	282 (11.10)	23 (0.906)	6 (0.236)	26 (1.02)	6 (0.236)	134 (5.28)	233 (9.17)	M5
2021 <sup>*1</sup>	140 (5.51)	294 (11.57)	138 (5.43)	73 (2.87)	102 (4.02)	102 (4.02)	16 (0.630)	3 (0.118)	282 (11.10)	23 (0.906)	6 (0.236)	26 (1.02)	6 (0.236)	134 (5.28)	233 (9.17)	M5
2030 <sup>*1</sup>	140 (5.51)	294 (11.57)	138 (5.43)	73 (2.87)	102 (4.02)	102 (4.02)	16 (0.630)	3 (0.118)	282 (11.10)	23 (0.906)	6 (0.236)	26 (1.02)	6 (0.236)	134 (5.28)	233 (9.17)	M5
2042 <sup>*1</sup>	140 (5.51)	294 (11.57)	138 (5.43)	73 (2.87)	102 (4.02)	102 (4.02)	16 (0.630)	3 (0.118)	282 (11.10)	23 (0.906)	6 (0.236)	26 (1.02)	6 (0.236)	134 (5.28)	233 (9.17)	M5
2056 <sup>*1</sup>	180 (7.09)	329 (12.95)	134 (5.28)	68 (2.68)	140 (5.51)	140 (5.51)	17 (0.669)	3 (0.118)	318 (12.52)	23.5 (0.925)	5 (0.197)	24.5 (0.965)	6 (0.236)	174 (6.85)	270 (10.63)	M5
2070 <sup>*1</sup>	220 (8.66)	384 (15.12)	140 (5.51)	87 (3.43)	192 (7.56)	192 (7.56)	11 (0.433)	3 (0.118)	371 (14.61)	27 (1.063)	7 (0.276)	25 (0.984)	6 (0.236)	214 (8.43)	319 (12.56)	M6
2082 <sup>*1</sup>	220 (8.66)	384 (15.12)	140 (5.51)	87 (3.43)	192 (7.56)	192 (7.56)	11 (0.433)	3 (0.118)	371 (14.61)	27 (1.063)	7 (0.276)	25 (0.984)	6 (0.236)	214 (8.43)	319 (12.56)	M6
2110	240 (9.45)	400 (15.75)	166 (6.54)	114 (4.49)	195 (7.68)	204 (8.03)	14.5 (0.571)	8 (0.315)	385 (15.16)	19.5 (0.768)	7.5 (0.295)	19.5 (0.768)	7.5 (0.295)	224 (8.82)	346 (13.62)	M6
2138	255 (10.04)	450 (17.72)	166 (6.54)	114 (4.49)	170 (6.69)	210 (8.27)	34.5 (1.36)	8 (0.315)	436 (17.17)	20 (0.787)	8 (0.315)	20 (0.787)	6 (0.236)	239 (9.41)	396 (15.59)	M6
2169	264 (10.39)	543 (21.38)	186 (7.32)	149 (5.87)	190 (7.48)	220 (8.66)	29 (1.14)	8 (0.315)	527 (20.75)	19.5 (0.768)	8.5 (0.335)	20.5 (0.807)	7.5 (0.295)	248 (9.76)	487 (19.17)	M8
2211	264 (10.39)	543 (21.38)	186 (7.32)	149 (5.87)	190 (7.48)	220 (8.66)	29 (1.14)	8 (0.315)	527 (20.75)	19.5 (0.768)	8.5 (0.335)	20.5 (0.807)	7.5 (0.295)	248 (9.76)	487 (19.17)	M8
2257	312 (12.28)	700 (27.56)	260 (10.24)	160 (6.30)	218 (8.58)	263 (10.35)	39 (1.54)	8 (0.315)	675 (26.56)	33 (1.299)	12 (0.472)	32 (1.26)	13 (0.512)	296 (11.65)	610 (24.02)	M10
2313	312 (12.28)	700 (27.56)	260 (10.24)	160 (6.30)	218 (8.58)	263 (10.35)	39 (1.54)	8 (0.315)	675 (26.56)	33 (1.299)	12 (0.472)	32 (1.26)	13 (0.512)	296 (11.65)	610 (24.02)	M10
2360	440 (17.32)	800 (31.50)	254 (10.00)	218 (8.58)	370 (14.57)	310 (12.20)	23 (0.91)	12 (0.472)	773 (30.43)	31.5 (1.240)	14 (0.551)	31.5 (1.24)	13 (0.512)	416 (16.38)	710 (27.95)	M12
2415	440 (17.32)	800 (31.50)	254 (10.00)	218 (8.58)	370 (14.57)	310 (12.20)	23 (0.91)	12 (0.472)	773 (30.43)	31.5 (1.240)	14 (0.551)	31.5 (1.24)	13 (0.512)	416 (16.38)	710 (27.95)	M12

\*1 The attachment for external heatsink installation is necessary.

Table 2.14 Panel Cut-Out Dimensions (400 V Class)

Model	Dimensions mm (in.)																	
	W	H	D1	D2	W1	W2	W3	W4	W5	W6	H1	H2	H3	H4	H5	A	B	d1
4002 */	140 (5.51)	294 (11.57)	138 (5.43)	38 (1.50)	102 (4.02)	102 (4.02)	16 (0.630)	3 (0.118)	-	-	282 (11.10)	23 (0.906)	6 (0.236)	26 (1.02)	6 (0.236)	134 (5.28)	233 (9.17)	M5
4004 */	140 (5.51)	294 (11.57)	138 (5.43)	38 (1.50)	102 (4.02)	102 (4.02)	16 (0.630)	3 (0.118)	-	-	282 (11.10)	23 (0.906)	6 (0.236)	26 (1.02)	6 (0.236)	134 (5.28)	233 (9.17)	M5
4005 */	140 (5.51)	294 (11.57)	138 (5.43)	38 (1.50)	102 (4.02)	102 (4.02)	16 (0.630)	3 (0.118)	-	-	282 (11.10)	23 (0.906)	6 (0.236)	26 (1.02)	6 (0.236)	134 (5.28)	233 (9.17)	M5
4007 */	140 (5.51)	294 (11.57)	138 (5.43)	73 (2.87)	102 (4.02)	102 (4.02)	16 (0.630)	3 (0.118)	-	-	282 (11.10)	23 (0.906)	6 (0.236)	26 (1.02)	6 (0.236)	134 (5.28)	233 (9.17)	M5
4009 */	140 (5.51)	294 (11.57)	138 (5.43)	73 (2.87)	102 (4.02)	102 (4.02)	16 (0.630)	3 (0.118)	-	-	282 (11.10)	23 (0.906)	6 (0.236)	26 (1.02)	6 (0.236)	134 (5.28)	233 (9.17)	M5
4012 */	140 (5.51)	294 (11.57)	138 (5.43)	73 (2.87)	102 (4.02)	102 (4.02)	16 (0.630)	3 (0.118)	-	-	282 (11.10)	23 (0.906)	6 (0.236)	26 (1.02)	6 (0.236)	134 (5.28)	233 (9.17)	M5
4018 */	140 (5.51)	294 (11.57)	138 (5.43)	73 (2.87)	102 (4.02)	102 (4.02)	16 (0.630)	3 (0.118)	-	-	282 (11.10)	23 (0.906)	6 (0.236)	26 (1.02)	6 (0.236)	134 (5.28)	233 (9.17)	M5
4023 */	140 (5.51)	294 (11.57)	138 (5.43)	73 (2.87)	102 (4.02)	102 (4.02)	16 (0.630)	3 (0.118)	-	-	282 (11.10)	23 (0.906)	6 (0.236)	26 (1.02)	6 (0.236)	134 (5.28)	233 (9.17)	M5
4031 */	180 (7.09)	329 (12.95)	134 (5.28)	68 (2.68)	140 (5.51)	140 (5.51)	17 (0.669)	3 (0.118)	-	-	318 (12.52)	23.5 (0.925)	5 (0.197)	24.5 (0.965)	6 (0.236)	174 (6.85)	270 (10.63)	M5
4038 */	180 (7.09)	329 (12.95)	134 (5.28)	68 (2.68)	140 (5.51)	140 (5.51)	17 (0.669)	3 (0.118)	-	-	318 (12.52)	23.5 (0.925)	5 (0.197)	24.5 (0.965)	6 (0.236)	174 (6.85)	270 (10.63)	M5
4044 */	220 (8.66)	384 (15.12)	140 (5.51)	87 (3.43)	192 (7.56)	192 (7.56)	11 (0.433)	3 (0.118)	-	-	371 (14.61)	27 (1.063)	7 (0.276)	25 (0.984)	6 (0.236)	214 (8.43)	319 (12.56)	M6
4060 */	220 (8.66)	384 (15.12)	140 (5.51)	106 (4.17)	192 (7.56)	192 (7.56)	11 (0.433)	3 (0.118)	-	-	371 (14.61)	27 (1.063)	7 (0.276)	25 (0.984)	6 (0.236)	214 (8.43)	319 (12.56)	M6
4075	240 (9.45)	400 (15.75)	166 (6.54)	114 (4.49)	195 (7.68)	204 (8.03)	14.5 (0.571)	8 (0.315)	-	-	385 (15.16)	19.5 (0.768)	7.5 (0.295)	19.5 (0.768)	7.5 (0.295)	224 (8.82)	346 (13.62)	M6
4089	255 (10.04)	450 (17.72)	166 (6.54)	114 (4.49)	170 (6.69)	210 (8.27)	34.5 (1.36)	8 (0.315)	-	-	436 (17.17)	20 (0.787)	8 (0.315)	20 (0.787)	6 (0.236)	239 (9.41)	396 (15.59)	M6
4103	255 (10.04)	450 (17.72)	166 (6.54)	114 (4.49)	170 (6.69)	210 (8.27)	34.5 (1.36)	8 (0.315)	-	-	436 (17.17)	20 (0.787)	8 (0.315)	20 (0.787)	6 (0.236)	239 (9.41)	396 (15.59)	M6
4140	264 (10.39)	543 (21.38)	186 (7.32)	149 (5.87)	190 (7.48)	220 (8.66)	29 (1.14)	8 (0.315)	-	-	527 (20.75)	19.5 (0.768)	8.5 (0.335)	20.5 (0.807)	7.5 (0.295)	248 (9.76)	487 (19.17)	M8
4168	264 (10.39)	543 (21.38)	186 (7.32)	149 (5.87)	190 (7.48)	220 (8.66)	29 (1.14)	8 (0.315)	-	-	527 (20.75)	19.5 (0.768)	8.5 (0.335)	20.5 (0.807)	7.5 (0.295)	248 (9.76)	487 (19.17)	M8
4208	312 (12.28)	700 (27.56)	260 (10.24)	160 (6.30)	218 (8.58)	263 (10.35)	39 (1.54)	8 (0.315)	-	-	675 (26.56)	33 (1.299)	12 (0.472)	32 (1.26)	13 (0.512)	296 (11.65)	610 (24.02)	M10

## 2.10 Installation Methods

Model	Dimensions mm (in.)																	
	W	H	D1	D2	W1	W2	W3	W4	W5	W6	H1	H2	H3	H4	H5	A	B	d1
4250	312 (12.28)	700 (27.56)	260 (10.24)	160 (6.30)	218 (8.58)	263 (10.35)	39 (1.54)	8 (0.315)	-	-	675 (26.56)	33 (1.299)	12 (0.472)	32 (1.26)	13 (0.512)	296 (11.65)	610 (24.02)	M10
4296	312 (12.28)	700 (27.56)	260 (10.24)	160 (6.30)	218 (8.58)	263 (10.35)	39 (1.54)	8 (0.315)	-	-	675 (26.56)	33 (1.299)	12 (0.472)	32 (1.26)	13 (0.512)	296 (11.65)	610 (24.02)	M10
4371	440 (17.32)	800 (31.50)	254 (10.00)	218 (8.58)	370 (14.57)	310 (12.20)	23 (0.91)	12 (0.472)	-	-	773 (30.43)	31.5 (1.240)	14 (0.551)	31.5 (1.24)	13 (0.512)	416 (16.38)	710 (27.95)	M12
4389	440 (17.32)	800 (31.50)	254 (10.00)	218 (8.58)	370 (14.57)	310 (12.20)	23 (0.91)	12 (0.472)	-	-	773 (30.43)	31.5 (1.240)	14 (0.551)	31.5 (1.24)	13 (0.512)	416 (16.38)	710 (27.95)	M12
4453	510 (20.08)	1140 (44.88)	260 (10.24)	220 (8.66)	450 (17.72)	404 (15.91)	18 (0.71)	12 (0.472)	179 (7.05)	225 (8.86)	1110 (43.70)	34 (1.339)	15 (0.591)	34 (1.34)	15 (0.591)	486 (19.13)	1042 (41.02)	M12
4568	510 (20.08)	1140 (44.88)	260 (10.24)	220 (8.66)	450 (17.72)	404 (15.91)	18 (0.71)	12 (0.472)	179 (7.05)	225 (8.86)	1110 (43.70)	34 (1.339)	15 (0.591)	34 (1.34)	15 (0.591)	486 (19.13)	1042 (41.02)	M12
4675	510 (20.08)	1140 (44.88)	260 (10.24)	220 (8.66)	450 (17.72)	404 (15.91)	18 (0.71)	12 (0.472)	179 (7.05)	225 (8.86)	1110 (43.70)	34 (1.339)	15 (0.591)	34 (1.34)	15 (0.591)	486 (19.13)	1042 (41.02)	M12

\*1 The attachment for external heatsink installation is necessary.



## 2.11 Electrical Installation

**DANGER!** *Electrical Shock Hazard. Do not examine, connect, or disconnect wiring on an energized drive. Before servicing, disconnect all power to the equipment and wait for the time specified on the warning label at a minimum. The internal capacitor stays charged after the drive is de-energized. The charge indicator LED extinguishes when the DC bus voltage decreases below 50 Vdc. When all indicators are OFF, remove the covers before measuring for dangerous voltages to make sure that the drive is safe. Failure to obey will cause death or serious injury.*

**DANGER!** *Electrical Shock Hazard. Make sure that all electrical connections are correct and install all drive covers before energizing the drive. Use terminals for their intended function only. Incorrect wiring or ground connections, and incorrect repair of protective covers can cause death or serious injury.*

**WARNING!** *Electrical Shock Hazard. Correctly ground the drive before turning on the EMC filter switch. Failure to obey can cause death or serious injury.*

**WARNING!** *Electrical Shock Hazard. Use the drive terminals only for their intended function. Refer to the drive Technical Manual for more information about I/O terminals. Incorrect wiring, incorrect grounding, and unsatisfactory repair of the protective cover could cause death or serious injury and damage to the drive.*

### ◆ Standard Connection Diagram

Wire the drive as specified by [Figure 2.68](#).

**WARNING!** *Sudden Movement Hazard. Set the MFDI terminal parameters before you close the control circuit wiring. Incorrect Run/Stop circuit sequence settings can cause death or serious injury from moving equipment.*

**WARNING!** *Sudden Movement Hazard. Correctly wire the start/stop and safety circuits before energizing the drive. Momentarily closing a digital input terminal can start a drive that is programmed for 3-Wire control. Failure to obey can cause death or serious injury from moving equipment.*

**WARNING!** *Sudden Movement Hazard.*

*When using a 3-Wire sequence:*

- Set the drive for 3-Wire sequence.
- Set b1-17 = 0 [Run Command at Power Up = Disregard Existing RUN Command]
- Wire the drive for 3-Wire sequence.

*If these three conditions are correct, the motor can rotate in reverse when energizing the drive:*

- The drive is wired for 3-Wire sequence.
- The drive is set for a 2-Wire sequence (default).
- b1-17 = 1 [Accept Existing RUN Command]

*Failure to obey can cause death or serious injury from moving equipment.*

**WARNING!** *Sudden Movement Hazard. Execute the Application Preset function after checking I/O signal and the external sequence for the drive. Executing the Application Preset function (A1-06 ≠ 0) changes the I/O terminal function for the drive and may trigger unexpected operation in equipment. Failure to comply may cause death or serious injury.*

**NOTICE:** *Fire Hazard. Install sufficient branch circuit short circuit protection as specified by applicable codes and this manual. The drive is suited for circuits that supply not more than 100,000 RMS symmetrical amperes, 240 Vac maximum (200 V Class), 480 Vac maximum (400 V Class). Failure to obey can cause death or serious injury.*

**NOTICE:** *When the input voltage is 440 V or higher or if the wiring distance is longer than 100 m (328 ft.) be sure to use a drive duty motor or carefully monitor the motor insulation voltage. Failure to obey can cause damage to the motor insulation.*

**NOTICE:** *Do not connect the AC control circuit ground to the drive enclosure. Failure to obey can cause incorrect control circuit operation.*

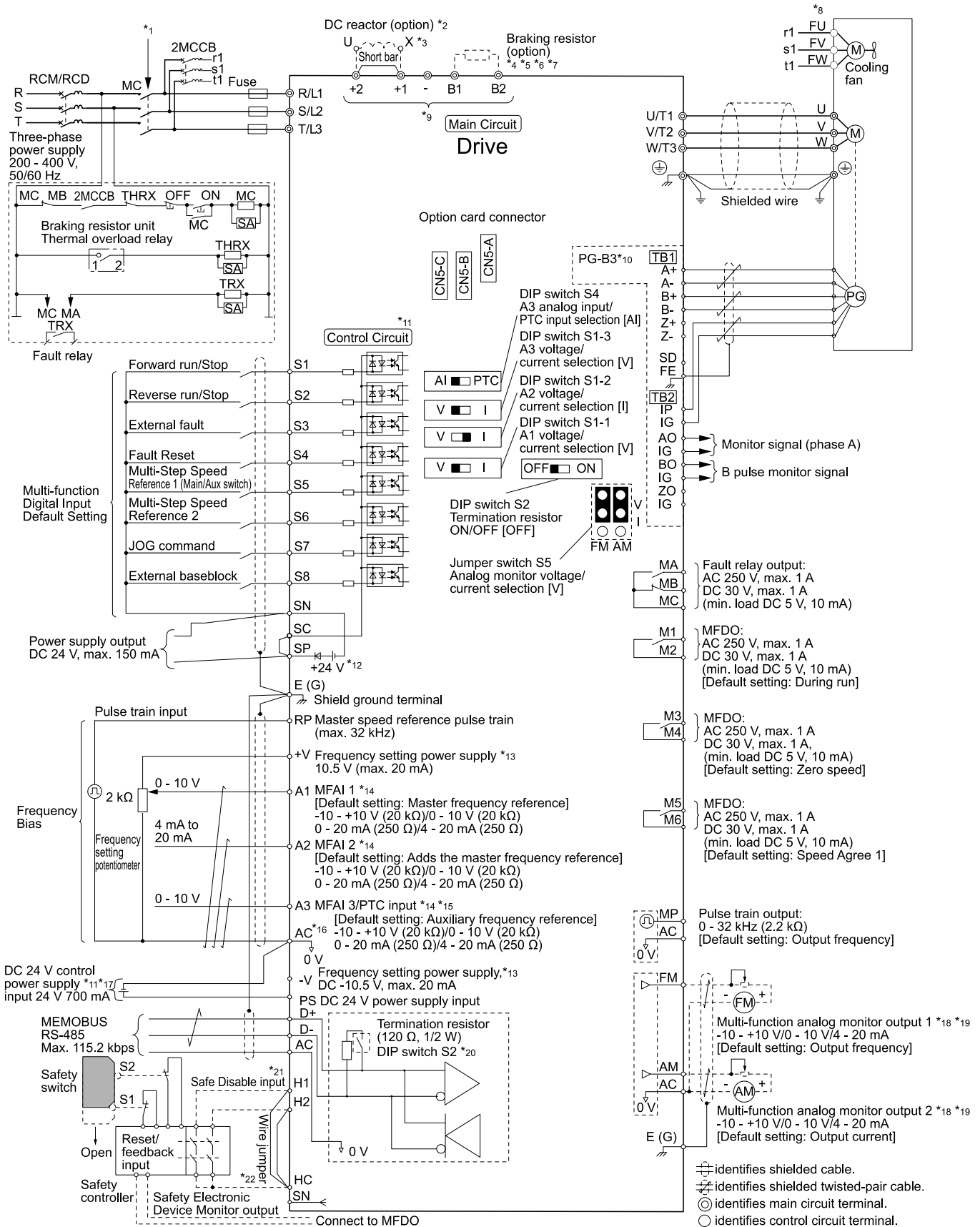


Figure 2.68 Standard Drive Connection Diagram

- \*1 Set the wiring sequence to de-energize the drive with the fault relay output. If the drive outputs a fault during fault restart when you use the fault restart function, set L5-02 = 1 [Fault Contact at Restart Select = Always Active] to de-energize the drive. Be careful when you use a cut-off sequence. The default setting for L5-02 is 0 [Active Only when Not Restarting].
- \*2 When you install a DC reactor, you must remove the jumper between terminals +1 and +2.

- \*3 Models 2110 to 2415 and 4060 to 4675 have a DC reactor.
- \*4 When you use an optional regenerative converter, regenerative unit, or braking unit, set  $L8-55 = 0$  [*Internal DB Transistor Protection = Disable*] to disable the protection function of the drive braking transistor. If  $L8-55 = 1$  [*Protection Enabled*], the drive will detect  $rF$  [*Braking Resistor Fault*].
- \*5 When you use a regenerative converter, regenerative unit, braking unit, braking resistor, or braking resistor unit, set  $L3-04 = 0$  [*Stall Prevention during Decel = Disabled*] If  $L3-04 = 1$  [*General Purpose*], the drive could possibly not stop in the specified deceleration time.
- \*6 When you use an ERF-type braking resistor, set  $L8-01 = 1$  [*3% ERF DB Resistor Protection = Enabled*] and set a wiring sequence to de-energize the drive with the fault relay output.
- \*7 When you connect a braking unit (CDBR series) or a braking resistor unit (LKEB series) to drive models 2110, 2138, and 4103, make sure that you use wires that are in the range of the applicable gauges for the drive. A junction terminal is necessary to connect wires that are less than the applicable gauge to the drive. Contact Yaskawa or your nearest sales representative for more information about selection and installation of the junction terminal.
- \*8 Cooling fan wiring is not necessary for self-cooling motors.
- \*9 Connect peripheral options to terminals -, +1, +2, B1, and B2.  
**WARNING!** *Electrical Shock Hazard. Use terminals -, +1, +2, B1, and B2 to connect options to the drive. Do not connect an AC power supply lines to these terminals. Failure to obey can cause death or serious injury.*
- \*10 Encoder circuit wiring (wiring to PG-B3 option card) is not necessary for applications that do not use motor speed feedback.
- \*11 Connect 24 V power to terminal PS-AC while the power to the drive control circuit is ON and only the main circuit is OFF.
- \*12 Install a wire jumper between terminals SC-SP-SN to select the type of the power supply for MFDI (sinking/sourcing mode or internal/external power supply).  
**NOTICE:** *Do not close the circuit between terminals SP and SN. Failure to obey will cause damage to the drive.*
  - Sinking Mode: Install a jumper between terminals SC and SP.  
**NOTICE:** *Do not close the circuit between terminals SC and SN. Failure to obey will cause damage to the drive.*
  - Sourcing Mode: Install a jumper between terminals SC and SN.  
**NOTICE:** *Do not close the circuit between terminals SC and SP. Failure to obey will cause damage to the drive.*
  - External power supply: Remove the wire jumper between terminals SC-SN and terminals SC-SP.
- \*13 The maximum output current capacity for terminals +V and -V on the control circuit is 20 mA.  
**NOTICE:** *Do not install a jumper between terminals +V, -V, and AC. Failure to obey can cause damage to the drive.*
- \*14 DIP switches S1-1 to S1-3 set terminals A1 to A3 for voltage or current input. The default setting for S1-1 and S1-3 is voltage input ("V" side). The default setting for S1-2 is current input ("I" side).
- \*15 DIP switch S4 sets terminal A3 for analog or PTC input. Set DIP switch S1-3 to the "V" side, and set  $H3-05 = 0$  [*Terminal A3 Signal Level Select = 0 to 10V (Lower Limit at 0)*] to set terminal A3 for PTC input with DIP switch S4.
- \*16 Do not ground the control circuit terminals AC or connect them to the drive.  
**WARNING!** *Do not connect the AC control circuit terminals to ground. Failure to obey can cause drive malfunction or failure.*
- \*17 Connect the positive lead from an external 24 Vdc power supply to terminal PS and the negative lead to terminal AC.  
**NOTICE:** *Do not connect terminals PS and AC inversely. Failure to obey will cause damage to the drive.*
- \*18 Use multi-function analog monitor outputs with analog frequency meters, ammeters, voltmeters, and wattmeters. Do not use monitor outputs with feedback-type signal devices.
- \*19 Jumper switch S5 sets terminal FM and AM for voltage or current output. The default setting for S5 is voltage output ("V" side).
- \*20 Set DIP switch S2 to "ON" to enable the termination resistor in the last drive in a MEMOBUS/Modbus network.
- \*21 Use only SOURCE Mode for Safe Disable input.
- \*22 Disconnect the wire jumper between H1 and HC, and H2 and HC to use the Safe Disable input.

## 2.12 Main Circuit Wiring

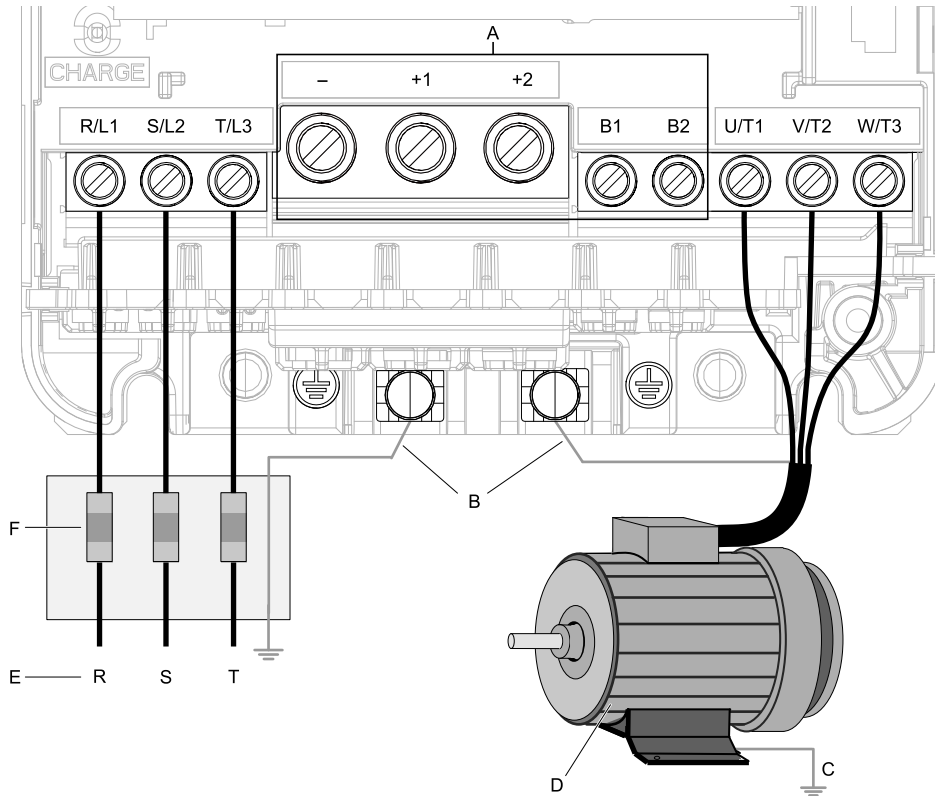
This section gives information about the functions, specifications, and procedures necessary to safely and correctly wire the main circuit in the drive.

**NOTICE:** Do not solder the ends of wire connections to the drive. Soldered wiring connections can become loose. Incorrect wiring procedures can cause drive malfunction because of loose terminal connections.

**NOTICE:** Turn the drive ON (Run) and OFF (Stop) a maximum of one time each 30 minutes with the MC on the power source side to extend the service life of the relay contacts and electrolytic capacitors in the drive. Run and Stop the motor as much as possible with the drive. The drive can fail if users frequently turn the drive ON and OFF with the MC on the power source side to Run and Stop the drive. Incorrect operation can decrease the service life of the relay contacts and electrolytic capacitors.

### ◆ Motor and Main Circuit Connections

**WARNING!** Electrical Shock Hazard. Do not connect terminals R/L1, S/L2, T/L3, U/T1, V/T2, W/T3, -, +1, +2, +3, B1, or B2 to the ground terminal. Failure to obey can cause death, serious injury, or damage to equipment.



- A - DC bus terminal
- B - Connect to the drive ground terminal.
- C - Ground the motor case.
- D - Three-Phase Motor
- E - Use R, S, T for input power supply.
- F - Input Protection (Fuses or Circuit Breakers)

**Note:**

The location of terminals are different for different drive models.

**Figure 2.69** Wiring the Main Circuit and Motor

### ◆ Configuration of Main Circuit Terminal Block

Refer to [Table 2.15](#) for the configuration of drive main circuit terminals.

**Table 2.15** Figure 1 Configuration of the Main Circuit Terminal

Model	Figure
2004 - 2042, 4002 - 4023	<a href="#">Figure 2.70</a>
2056, 4031, 4038	<a href="#">Figure 2.71</a>
2070, 2082	<a href="#">Figure 2.72</a>
4044	<a href="#">Figure 2.73</a>

Model	Figure
4060	Figure 2.74
2110	Figure 2.75
4075	Figure 2.76
4089	Figure 2.77
2138, 4103	Figure 2.78
2169, 2211, 4140, 4168	Figure 2.79
2257, 2313, 4208 - 4296	Figure 2.80
2360, 2415, 4371, 4389	Figure 2.81
4453 - 4675	Figure 2.82

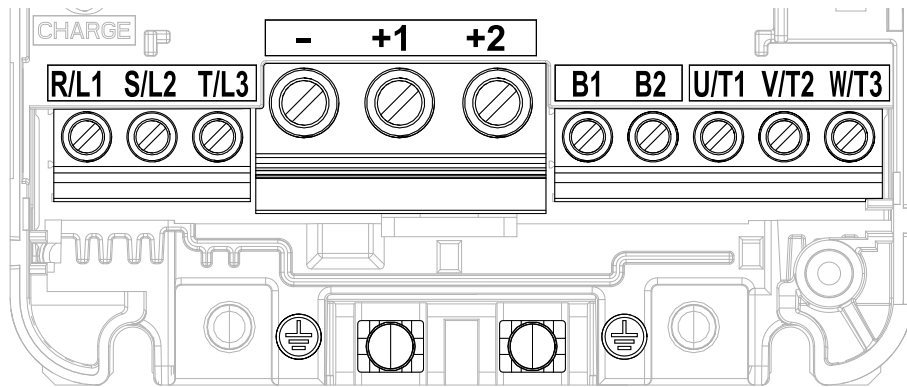


Figure 2.70 Configuration of Main Circuit Terminal Block

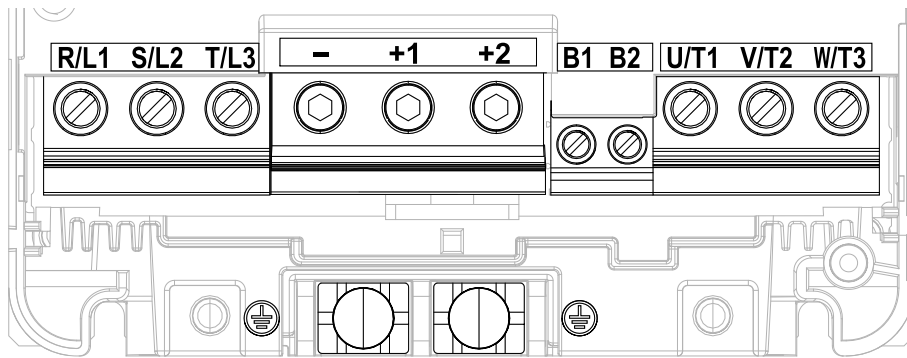


Figure 2.71 Configuration of Main Circuit Terminal Block

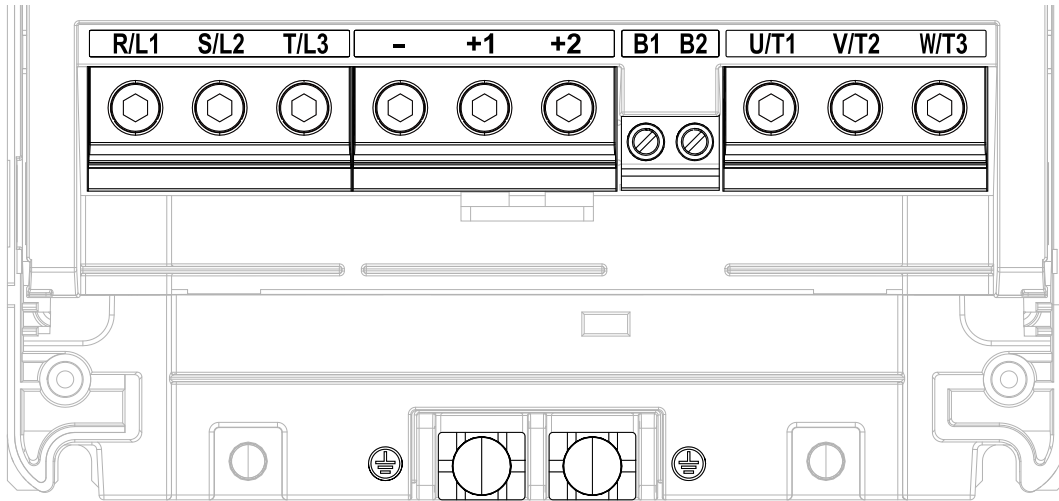


Figure 2.72 Configuration of Main Circuit Terminal Block

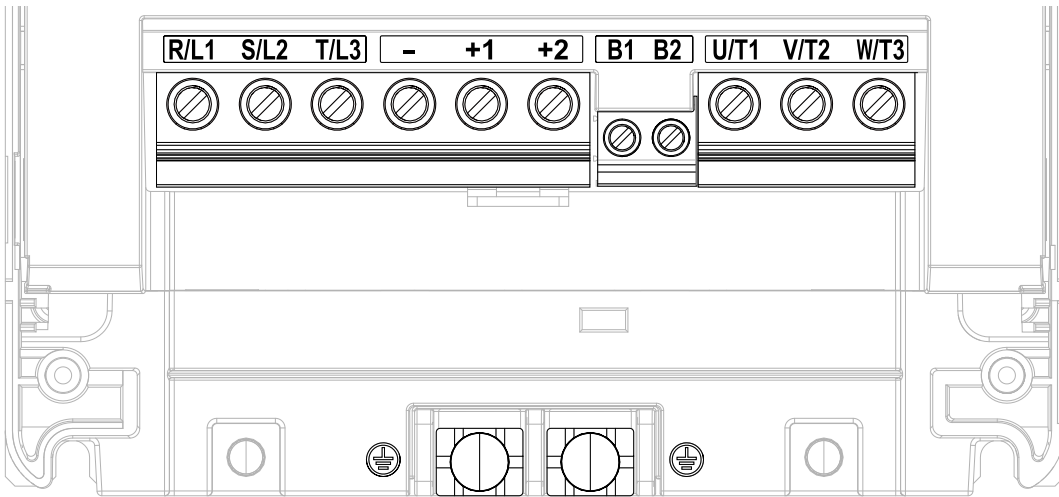


Figure 2.73 Configuration of Main Circuit Terminal Block

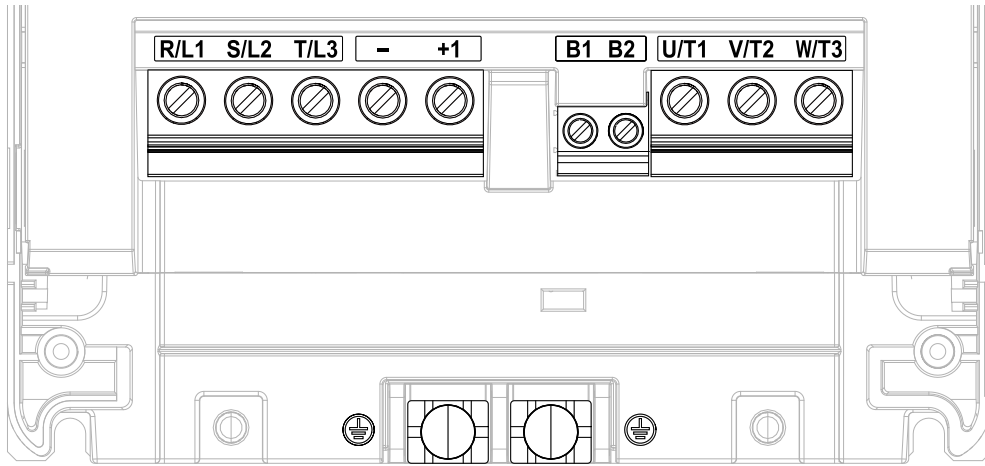


Figure 2.74 Configuration of Main Circuit Terminal Block

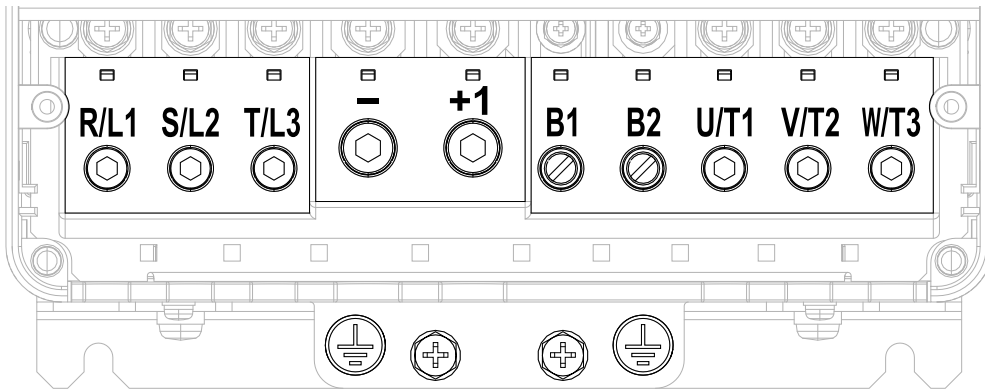


Figure 2.75 Configuration of Main Circuit Terminal Block

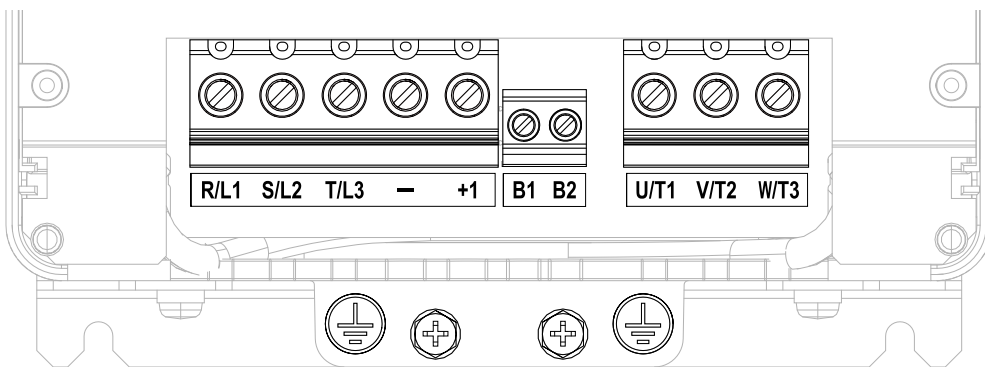


Figure 2.76 Configuration of Main Circuit Terminal Block

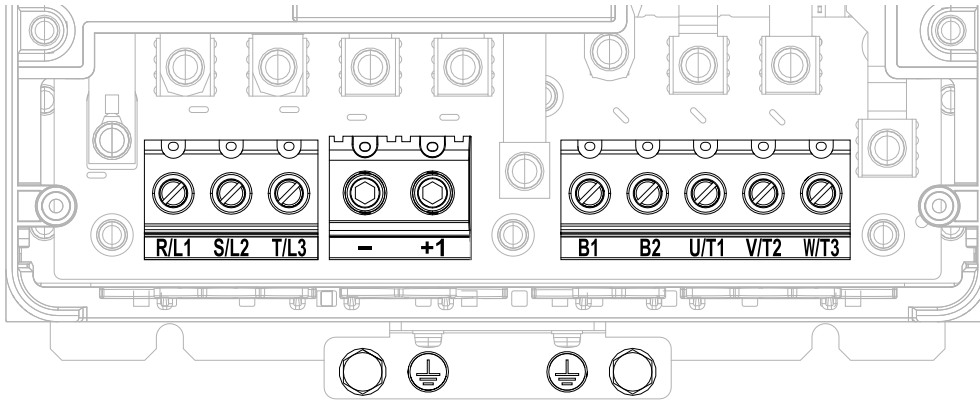


Figure 2.77 Configuration of Main Circuit Terminal Block

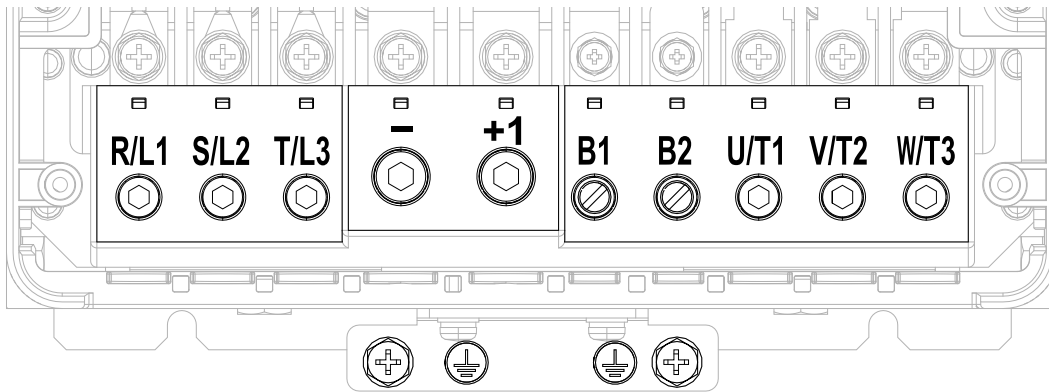


Figure 2.78 Configuration of Main Circuit Terminal Block

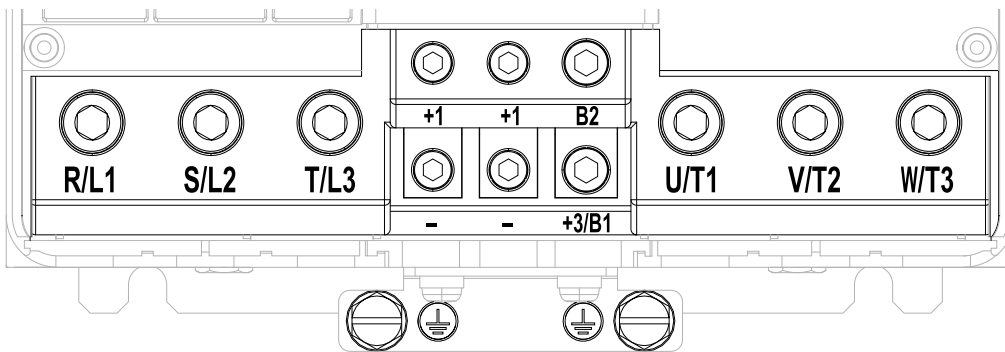


Figure 2.79 Configuration of Main Circuit Terminal Block



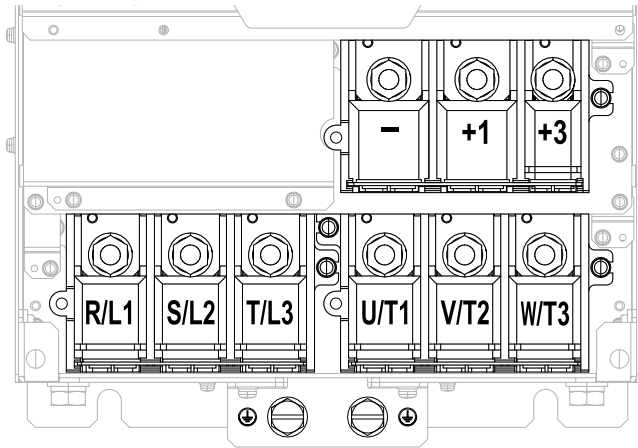


Figure 2.80 Configuration of Main Circuit Terminal Block

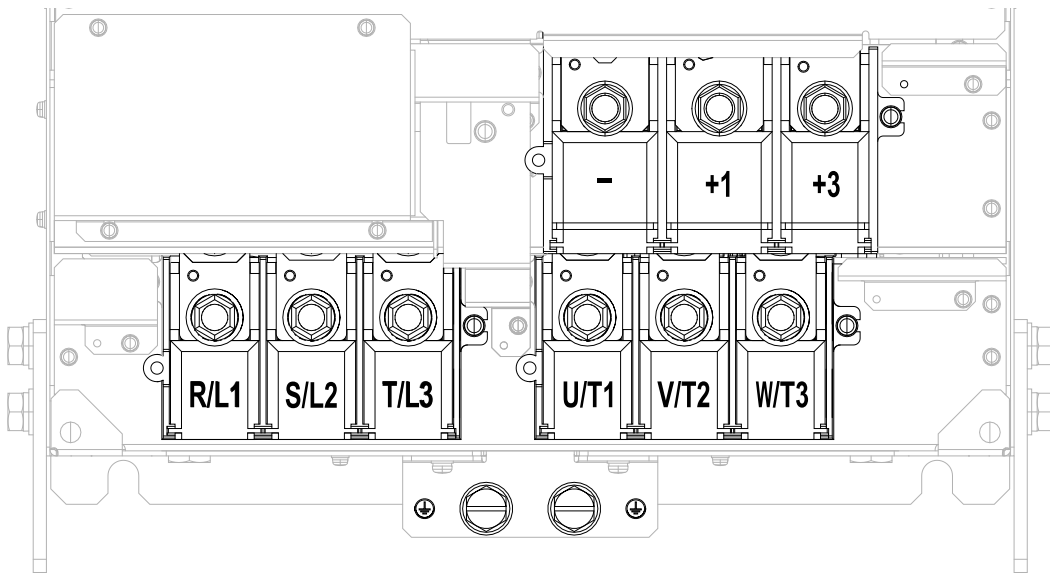


Figure 2.81 Configuration of Main Circuit Terminal Block

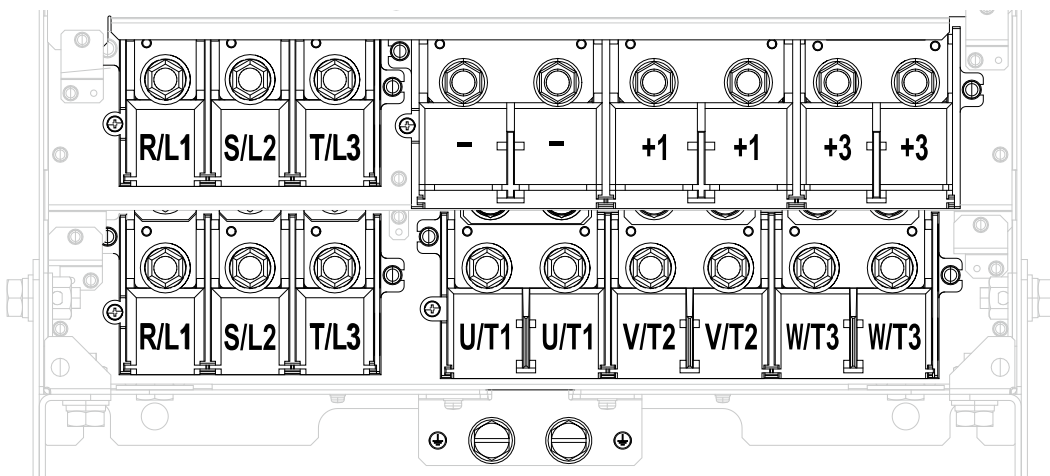


Figure 2.82 Configuration of Main Circuit Terminal Block

### ◆ Main Circuit Terminal Functions

Refer to [Table 2.16](#) for the functions of drive main circuit terminals.

Table 2.16 Main Circuit Terminal Functions

Terminals	Name			Function
	2004 - 2082	2110 - 2138	2169 - 2415	
Model	4002 - 4044	4060 - 4168	4208 - 4675	
	R/L1	Main circuit power supply input		
S/L2				
T/L3				
U/T1	Drive output			To connect a motor.
V/T2				
W/T3				
B1	Braking resistor connection		-	To connect a braking resistor or braking resistor unit.
B2				
+2	<ul style="list-style-type: none"> <li>DC power supply input (+1 and -)</li> <li>DC reactor connection (+1 and +2)</li> </ul>	DC power supply input (+1 and -)	-	To connect peripheral devices, for example: <ul style="list-style-type: none"> <li>DC power input</li> <li>Braking Unit</li> <li>DC Reactor</li> </ul> <b>Note:</b> Remove the jumper between terminals +1 and +2 to connect a DC reactor.
+1				
-				
+3	-		<ul style="list-style-type: none"> <li>DC power supply input (+1 and -)</li> <li>Braking unit connection (+3 and -)</li> </ul>	
⊕	<ul style="list-style-type: none"> <li>200 V: D class grounding (ground to 100 Ω or less)</li> <li>400 V: C class grounding (ground to 10 Ω or less)</li> </ul>			To ground the drive.

**Note:**

Use terminals B1 and - to connect a CDBR-type control unit to drive models 2004 to 2138 and 4002 to 4168 that have built-in braking transistors.

## ◆ Wire Selection

Select the correct wires for main circuit wiring.

Refer to [Main Circuit Wire Gauges and Tightening Torques on page 231](#) for wire gauges and tightening torques as specified by European standards.

Refer to [Main Circuit Wire Gauges and Tightening Torques on page 258](#) for wire gauges and tightening torques as specified by UL standards.

## ■ Wire Selection Precautions

**WARNING! Electrical Shock Hazard.** The leakage current of the drive will be more than 3.5 mA in drive models 2xxxB, 2xxxC, 4002B to 4371B, 4002C to 4371C (with built-in EMC filter turned ON) and 4389 to 4675. The IEC/EN 61800-5-1: 2007 standard specifies that users must wire the power supply to automatically turn off when the protective ground wire disconnects. Users can also connect a protective ground wire that has a minimum cross-sectional area of 10 mm<sup>2</sup> (copper wire) or 16 mm<sup>2</sup> (aluminum wire). Failure to obey these standards can cause death or serious injury.

Think about line voltage drop before selecting wire gauges. Select wire gauges that drop the voltage by 2% or less of the rated voltage. Increase the wire gauge and the cable length when the risk of voltage drops increases.

Calculate line voltage drop with this formula:

$$\text{Line voltage drop (V)} = \sqrt{3} \times \text{wire resistance } (\Omega/\text{km}) \times \text{wiring distance (m)} \times \text{motor rated current (A)} \times 10^{-3}$$

## ■ Precautions during Wiring

- Use terminals B1 and - to connect braking units to drives that have built-in braking transistors (models 2004 to 2138 and 4002 to 4168). Use terminals +3 and - to connect braking units to drives that do not have built-in braking transistors.
- Refer to “Yaskawa AC Drive Option Braking Unit, Braking Resistor Unit Instruction Manual (TOBPC72060001)” for information about wire gauges and tightening torques to connect braking resistor units or braking units.
- Use terminals +1 and - to connect a regenerative converter or regenerative unit.

**NOTICE:** Do not connect a braking resistor to terminals +1 or -. Failure to obey can cause damage to the drive circuitry.

## ■ Wire Gauges and Tightening Torques

**WARNING! Electrical Shock Hazard.** The leakage current of the drive will be more than 3.5 mA in drive models 2xxxB, 2xxxC, 4002B to 4371B, 4002C to 4371C (with built-in EMC filter turned ON) and 4389 to 4675. The IEC/EN 61800-5-1: 2007 standard specifies that users must wire the power supply to automatically turn off when the protective ground wire disconnects. Users can also connect a protective ground wire that has a minimum cross-sectional area of 10 mm<sup>2</sup> (copper wire) or 16 mm<sup>2</sup> (aluminum wire). Failure to obey these standards can cause death or serious injury.

### Note:

- The recommended wire gauges are based on drive continuous current ratings with 75 °C (167 °F) 600 V class 2 heat-resistant indoor PVC wire. Assume these conditions:
  - Ambient temperature: 40 °C (104 °F) or lower
  - Wiring distance: 100 m (3281 ft.) or shorter
  - Normal Duty Rated current value
- Use terminals +1, +2, +3, -, B1, and B2 to connect a peripheral option such as a DC reactor or a braking resistor. Do not connect other items to these terminals.
- Refer to the instruction manual for each device for recommended wire gauges to connect peripheral devices or options to terminals +1, +2, +3, -, B1, and B2. Contact Yaskawa or your nearest sales representative if the recommended wire gauges for the peripheral devices or options are out of the range of the applicable gauges for the drive.

### Three-Phase 200 V Class

Model	Terminals	Recommended Gauge mm <sup>2</sup>	Applicable Gauge (IP20 Applicable Gauge <sup>*</sup> ) mm <sup>2</sup>	Wire Stripping Length <sup>*2</sup> mm	Terminal Screw		Tightening Torque N·m (lb·in.)
					Size	Shape	
2004	R/L1, S/L2, T/L3	2.5	2.5 - 10 (2.5 - 10)	10	M4	Slotted (-)	1.5 - 1.7 (13.5 - 15)
	U/T1, V/T2, W/T3	2.5	2.5 - 10 (2.5 - 10)	10	M4	Slotted (-)	1.5 - 1.7 (13.5 - 15)
	-, +1, +2	2.5	2.5 - 16 (2.5 - 16)	18	M5	Slotted (-)	2.3 - 2.5 (19.8 - 22) <sup>*3</sup>
	B1, B2	2.5	2.5 - 4 (2.5 - 4)	10	M4	Slotted (-)	1.5 - 1.7 (13.5 - 15)
	⊕	2.5 <sup>*4</sup>	2.5 - 10 (-)	-	M4	Phillips/slotted combo	1.2 - 1.5 (10.6 - 13.3)
2006	R/L1, S/L2, T/L3	2.5	2.5 - 10 (2.5 - 10)	10	M4	Slotted (-)	1.5 - 1.7 (13.5 - 15)
	U/T1, V/T2, W/T3	2.5	2.5 - 10 (2.5 - 10)	10	M4	Slotted (-)	1.5 - 1.7 (13.5 - 15)
	-, +1, +2	2.5	2.5 - 16 (2.5 - 16)	18	M5	Slotted (-)	2.3 - 2.5 (19.8 - 22) <sup>*3</sup>
	B1, B2	2.5	2.5 - 4 (2.5 - 4)	10	M4	Slotted (-)	1.5 - 1.7 (13.5 - 15)
	⊕	2.5 <sup>*4</sup>	2.5 - 10 (-)	-	M4	Phillips/slotted combo	1.2 - 1.5 (10.6 - 13.3)
2010	R/L1, S/L2, T/L3	2.5	2.5 - 10 (2.5 - 10)	10	M4	Slotted (-)	1.5 - 1.7 (13.5 - 15)
	U/T1, V/T2, W/T3	2.5	2.5 - 10 (2.5 - 10)	10	M4	Slotted (-)	1.5 - 1.7 (13.5 - 15)
	-, +1, +2	2.5	2.5 - 16 (2.5 - 16)	18	M5	Slotted (-)	2.3 - 2.5 (19.8 - 22) <sup>*3</sup>
	B1, B2	2.5	2.5 - 4 (2.5 - 4)	10	M4	Slotted (-)	1.5 - 1.7 (13.5 - 15)
	⊕	2.5 <sup>*4</sup>	2.5 - 10 (-)	-	M4	Phillips/slotted combo	1.2 - 1.5 (10.6 - 13.3)

## 2.12 Main Circuit Wiring

Model	Terminals	Recommended Gauge mm <sup>2</sup>	Applicable Gauge (IP20 Applicable Gauge <sup>*)</sup> mm <sup>2</sup>	Wire Stripping Length <sup>*)</sup> mm	Terminal Screw		Tightening Torque N·m (lb·in.)
					Size	Shape	
2012	R/L1, S/L2, T/L3	2.5	2.5 - 10 (2.5 - 10)	10	M4	Slotted (-)	1.5 - 1.7 (13.5 - 15)
	U/T1, V/T2, W/T3	2.5	2.5 - 10 (2.5 - 10)	10	M4	Slotted (-)	1.5 - 1.7 (13.5 - 15)
	-, +1, +2	2.5	2.5 - 16 (2.5 - 16)	18	M5	Slotted (-)	2.3 - 2.5 (19.8 - 22) <sup>*)</sup>
	B1, B2	2.5	2.5 - 4 (2.5 - 4)	10	M4	Slotted (-)	1.5 - 1.7 (13.5 - 15)
	⊕	2.5 <sup>*)</sup>	2.5 - 10 (-)	-	M4	Phillips/slotted combo	1.2 - 1.5 (10.6 - 13.3)
2018	R/L1, S/L2, T/L3	2.5	2.5 - 10 (2.5 - 10)	10	M4	Slotted (-)	1.5 - 1.7 (13.5 - 15)
	U/T1, V/T2, W/T3	2.5	2.5 - 10 (2.5 - 10)	10	M4	Slotted (-)	1.5 - 1.7 (13.5 - 15)
	-, +1, +2	4	2.5 - 16 (2.5 - 16)	18	M5	Slotted (-)	2.3 - 2.5 (19.8 - 22) <sup>*)</sup>
	B1, B2	2.5	2.5 - 4 (2.5 - 4)	10	M4	Slotted (-)	1.5 - 1.7 (13.5 - 15)
	⊕	2.5 <sup>*)</sup>	2.5 - 10 (-)	-	M4	Phillips/slotted combo	1.2 - 1.5 (10.6 - 13.3)
2021	R/L1, S/L2, T/L3	6	2.5 - 10 (2.5 - 10)	10	M4	Slotted (-)	1.5 - 1.7 (13.5 - 15)
	U/T1, V/T2, W/T3	2.5	2.5 - 10 (2.5 - 10)	10	M4	Slotted (-)	1.5 - 1.7 (13.5 - 15)
	-, +1, +2	6	2.5 - 16 (2.5 - 16)	18	M5	Slotted (-)	2.3 - 2.5 (19.8 - 22) <sup>*)</sup>
	B1, B2	2.5	2.5 - 4 (2.5 - 4)	10	M4	Slotted (-)	1.5 - 1.7 (13.5 - 15)
	⊕	6 <sup>*)</sup>	4 - 10 (-)	-	M4	Phillips/slotted combo	1.2 - 1.5 (10.6 - 13.3)
2030	R/L1, S/L2, T/L3	10	2.5 - 10 (2.5 - 10)	10	M4	Slotted (-)	1.5 - 1.7 (13.5 - 15)
	U/T1, V/T2, W/T3	6	2.5 - 10 (2.5 - 10)	10	M4	Slotted (-)	1.5 - 1.7 (13.5 - 15)
	-, +1, +2	10	2.5 - 16 (2.5 - 16)	18	M5	Slotted (-)	2.3 - 2.5 (19.8 - 22) <sup>*)</sup>
	B1, B2	2.5	2.5 - 4 (2.5 - 4)	10	M4	Slotted (-)	1.5 - 1.7 (13.5 - 15)
	⊕	10	6 - 10 (-)	-	M5	Phillips/slotted combo	2.0 - 2.5 (17.7 - 22.1)

Model	Terminals	Recommended Gauge mm <sup>2</sup>	Applicable Gauge (IP20 Applicable Gauge <sup>*)</sup> mm <sup>2</sup>	Wire Stripping Length <sup>*)</sup> mm	Terminal Screw		Tightening Torque N·m (lb·in.)
					Size	Shape	
2042	R/L1, S/L2, T/L3	10	2.5 - 10 (2.5 - 10)	10	M4	Slotted (-)	1.5 - 1.7 (13.5 - 15)
	U/T1, V/T2, W/T3	10	2.5 - 10 (2.5 - 10)	10	M4	Slotted (-)	1.5 - 1.7 (13.5 - 15)
	-, +1, +2	16	2.5 - 16 (2.5 - 16)	18	M5	Slotted (-)	2.3 - 2.5 (19.8 - 22) <sup>*)</sup>
	B1, B2	4	2.5 - 4 (2.5 - 4)	10	M4	Slotted (-)	1.5 - 1.7 (13.5 - 15)
	⊕	10	6 - 10 (-)	-	M5	Phillips/slotted combo	2.0 - 2.5 (17.7 - 22.1)
2056	R/L1, S/L2, T/L3	25	2.5 - 25 (10 - 25)	18	M5	Slotted (-)	2.3 - 2.5 (19.8 - 22) <sup>*)</sup>
	U/T1, V/T2, W/T3	16	2.5 - 16 (6 - 16)	18	M5	Slotted (-)	2.3 - 2.5 (19.8 - 22) <sup>*)</sup>
	-, +1, +2	35	2.5 - 35 (10 - 35)	20	M6	Hex socket cap (WAF: 5 mm)	5 - 5.5 (45 - 49)
	B1, B2	10	2.5 - 10 (2.5 - 10)	10	M4	Slotted (-)	1.5 - 1.7 (13.5 - 15)
	⊕	16	10 - 16 (-)	-	M6	Phillips/slotted combo	5.4 - 6.0 (47.8 - 53.1)
2070	R/L1, S/L2, T/L3	35	2.5 - 35 (25 - 35)	20	M6	Hex socket cap (WAF: 5 mm)	5 - 5.5 (45 - 49)
	U/T1, V/T2, W/T3	16	2.5 - 16 (16)	20	M6	Hex socket cap (WAF: 5 mm)	5 - 5.5 (45 - 49)
	-, +1, +2	50	2.5 - 50 (35 - 50)	20	M6	Hex socket cap (WAF: 5 mm)	5 - 5.5 (45 - 49)
	B1, B2	10	2.5 - 10 (2.5 - 10)	10	M4	Slotted (-)	1.5 - 1.7 (13.5 - 15)
	⊕	16	16 - 25 (-)	-	M6	Phillips/slotted combo	5.4 - 6.0 (47.8 - 53.1)
2082	R/L1, S/L2, T/L3	35	2.5 - 35 (25 - 35)	20	M6	Hex socket cap (WAF: 5 mm)	5 - 5.5 (45 - 49)
	U/T1, V/T2, W/T3	25	2.5 - 25 (16 - 25)	20	M6	Hex socket cap (WAF: 5 mm)	5 - 5.5 (45 - 49)
	-, +1, +2	50	2.5 - 50 (35 - 50)	20	M6	Hex socket cap (WAF: 5 mm)	5 - 5.5 (45 - 49)
	B1, B2	16	2.5 - 16 (2.5 - 16)	10	M4	Slotted (-)	1.5 - 1.7 (13.5 - 15)
	⊕	16	16 - 25 (-)	-	M6	Phillips/slotted combo	5.4 - 6.0 (47.8 - 53.1)

## 2.12 Main Circuit Wiring

Model	Terminals	Recommended Gauge mm <sup>2</sup>	Applicable Gauge (IP20 Applicable Gauge <sup>*/1</sup> ) mm <sup>2</sup>	Wire Stripping Length <sup>*/2</sup> mm	Terminal Screw		Tightening Torque N·m (lb·in.)
					Size	Shape	
2110	R/L1, S/L2, T/L3	35	16 - 35 (25 - 35)	27	M6	Hex socket cap (WAF: 5 mm)	8 - 9 (71 - 80)
	U/T1, V/T2, W/T3	35	16 - 35 (25 - 35)	27	M6	Hex socket cap (WAF: 5 mm)	8 - 9 (71 - 80)
	-, +1	50	25 - 50 (25 - 50)	27	M8	Hex socket cap (WAF: 6 mm)	10 - 12 (89 - 107)
	B1, B2	25	6 - 25 (6 - 25)	21	M6	Minus (-)	3 - 3.5 (27 - 31)
	⊕	16	16 - 25 (-)	-	M6	Hex bolt (+)	5.4 - 6.0 (47.8 - 53.1)
2138	R/L1, S/L2, T/L3	50	16 - 50 (50)	27	M6	Hex socket cap (WAF: 5 mm)	8 - 9 (71 - 80)
	U/T1, V/T2, W/T3	50	16 - 50 (50)	27	M6	Hex socket cap (WAF: 5 mm)	8 - 9 (71 - 80)
	-, +1	70	25 - 70 (50 - 70)	27	M8	Hex socket cap (WAF: 6 mm)	10 - 12 (89 - 107)
	B1, B2	35	6 - 35 (6 - 35)	21	M6	Minus (-)	3 - 3.5 (27 - 31)
	⊕	25	25 (-)	-	M6	Hex bolt (+)	5.4 - 6.0 (47.8 - 53.1)
2169	R/L1, S/L2, T/L3	70	50 - 95 (95)	37	M10	Hex socket cap (WAF: 8 mm)	12 - 14 (107 - 124)
	U/T1, V/T2, W/T3	70	50 - 95 (95)	37	M10	Hex socket cap (WAF: 8 mm)	12 - 14 (107 - 124)
	-, -, +1, +1 <sup>*5 *6</sup>	35	16 - 50 (50)	28	M6	Hex socket cap (WAF: 5 mm)	8 - 9 (71 - 80)
	+3 <sup>*6</sup>	50	25 - 70 (50 - 70)	28	M8	Hex socket cap (WAF: 6 mm)	8 - 9 (71 - 80)
	⊕	35	25 - 50 (-)	-	M8	Hex bolt (slotted)	9.0 - 11 (79.7 - 97.4)
2211	R/L1, S/L2, T/L3	95	50 - 95 (95)	37	M10	Hex socket cap (WAF: 8 mm)	12 - 14 (107 - 124)
	U/T1, V/T2, W/T3	95	50 - 95 (95)	37	M10	Hex socket cap (WAF: 8 mm)	12 - 14 (107 - 124)
	-, -, +1, +1 <sup>*5 *6</sup>	50	16 - 50 (50)	28	M6	Hex socket cap (WAF: 5 mm)	8 - 9 (71 - 80)
	+3 <sup>*6</sup>	70	25 - 70 (50 - 70)	28	M8	Hex socket cap (WAF: 6 mm)	8 - 9 (71 - 80)
	⊕	50	25 - 50 (-)	-	M8	Hex bolt (slotted)	9.0 - 11 (79.7 - 97.4)

Model	Terminals	Recommended Gauge mm <sup>2</sup>	Applicable Gauge (IP20 Applicable Gauge *) mm <sup>2</sup>	Wire Stripping Length *2 mm	Terminal Screw		Tightening Torque N·m (lb·in.)
					Size	Shape	
2257	R/L1, S/L2, T/L3	50 × 2P	25 - 95 × 2P (70 - 95 × 2P)	-	M10	Hex self-locking nut	20 (177)
	U/T1, V/T2, W/T3	50 × 2P	25 - 95 × 2P (70 - 95 × 2P)	-	M10	Hex self-locking nut	20 (177)
	-, +1	70 × 2P	35 - 120 × 2P (120 × 2P)	-	M10	Hex self-locking nut	20 (177)
	+3	35 × 2P	25 - 70 × 2P (70 × 2P)	-	M10	Hex self-locking nut	20 (177)
	⊕	95	95 - 240 (-)	-	M10	Hex bolt (slotted)	18 - 23 (159 - 204)
2313	R/L1, S/L2, T/L3	70 × 2P	25 - 95 × 2P (70 - 95 × 2P)	-	M10	Hex self-locking nut	20 (177)
	U/T1, V/T2, W/T3	70 × 2P	25 - 95 × 2P (70 - 95 × 2P)	-	M10	Hex self-locking nut	20 (177)
	-, +1	95 × 2P	35 - 120 × 2P (120 × 2P)	-	M10	Hex self-locking nut	20 (177)
	+3	50 × 2P	25 - 70 × 2P (70 × 2P)	-	M10	Hex self-locking nut	20 (177)
	⊕	95	95 - 240 (-)	-	M10	Hex bolt (slotted)	18 - 23 (159 - 204)
2360	R/L1, S/L2, T/L3	120 × 2P	70 - 150 × 2P (150 × 2P)	-	M12	Hex self-locking nut	35 (310)
	U/T1, V/T2, W/T3	120 × 2P	70 - 150 × 2P (150 × 2P)	-	M12	Hex self-locking nut	35 (310)
	-, +1	120 × 2P	95 - 185 × 2P (185 × 2P)	-	M12	Hex self-locking nut	35 (310)
	+3	70 × 2P	50 - 95 × 2P (-)	-	M12	Hex self-locking nut	35 (310)
	⊕	120	120 - 240 (-)	-	M12	Hex bolt (slotted)	32 - 40 (283 - 354)
2415	R/L1, S/L2, T/L3	120 × 2P	70 - 150 × 2P (150 × 2P)	-	M12	Hex self-locking nut	35 (310)
	U/T1, V/T2, W/T3	120 × 2P	70 - 150 × 2P (150 × 2P)	-	M12	Hex self-locking nut	35 (310)
	-, +1	120 × 2P	95 - 185 × 2P (185 × 2P)	-	M12	Hex self-locking nut	35 (310)
	+3	70 × 2P	50 - 95 × 2P (-)	-	M12	Hex self-locking nut	35 (310)
	⊕	120	120 - 240 (-)	-	M12	Hex bolt (slotted)	32 - 40 (283 - 354)

\*1 For IP20 protection, use wires that are in the range of applicable gauges.

\*2 Remove insulation from the ends of wires to expose the length of wire shown.

\*3 For wire gauges more than 30 mm<sup>2</sup>, tighten to a tightening torque of 4.1 N·m to 4.5 N·m (36 lb·in. to 40 lb·in.).

\*4 Install an RCM/RCD with this wire gauge to maintain compliance with IEC/EN 61800-5-1:2007.

\*5 Terminals - and +1 have two screws. The Recommended Gauge is the wire gauge for one terminal.

\*6 A junction terminal is necessary to connect a braking unit (CDBR-series) to terminals - and +3.

## Three-Phase 400 V Class

Model	Terminals	Recommended Gauge mm <sup>2</sup>	Applicable Gauge (IP20 Applicable Gauge <sup>*1</sup> ) mm <sup>2</sup>	Wire Stripping Length <sup>*2</sup> mm	Terminal Screw		Tightening Torque N·m (lb·in.)
					Size	Shape	
4002	R/L1, S/L2, T/L3	2.5	2.5 - 10 (2.5 - 10)	10	M4	Slotted (-)	1.5 - 1.7 (13.5 - 15)
	U/T1, V/T2, W/T3	2.5	2.5 - 10 (2.5 - 10)	10	M4	Slotted (-)	1.5 - 1.7 (13.5 - 15)
	-, +1, +2	2.5	2.5 - 16 (2.5 - 16)	18	M5	Slotted (-)	2.3 - 2.5 (19.8 - 22) <sup>*3</sup>
	B1, B2	2.5	2.5 - 4 (2.5 - 4)	10	M4	Slotted (-)	1.5 - 1.7 (13.5 - 15)
	⊕	2.5 <sup>*4</sup>	2.5 - 10 (-)	-	M4	Phillips/slotted combo	1.2 - 1.5 (10.6 - 13.3)
4004	R/L1, S/L2, T/L3	2.5	2.5 - 10 (2.5 - 10)	10	M4	Slotted (-)	1.5 - 1.7 (13.5 - 15)
	U/T1, V/T2, W/T3	2.5	2.5 - 10 (2.5 - 10)	10	M4	Slotted (-)	1.5 - 1.7 (13.5 - 15)
	-, +1, +2	2.5	2.5 - 16 (2.5 - 16)	18	M5	Slotted (-)	2.3 - 2.5 (19.8 - 22) <sup>*3</sup>
	B1, B2	2.5	2.5 - 4 (2.5 - 4)	10	M4	Slotted (-)	1.5 - 1.7 (13.5 - 15)
	⊕	2.5 <sup>*4</sup>	2.5 - 10 (-)	-	M4	Phillips/slotted combo	1.2 - 1.5 (10.6 - 13.3)
4005	R/L1, S/L2, T/L3	2.5	2.5 - 10 (2.5 - 10)	10	M4	Slotted (-)	1.5 - 1.7 (13.5 - 15)
	U/T1, V/T2, W/T3	2.5	2.5 - 10 (2.5 - 10)	10	M4	Slotted (-)	1.5 - 1.7 (13.5 - 15)
	-, +1, +2	2.5	2.5 - 16 (2.5 - 16)	18	M5	Slotted (-)	2.3 - 2.5 (19.8 - 22) <sup>*3</sup>
	B1, B2	2.5	2.5 - 4 (2.5 - 4)	10	M4	Slotted (-)	1.5 - 1.7 (13.5 - 15)
	⊕	2.5 <sup>*4</sup>	2.5 - 10 (-)	-	M4	Phillips/slotted combo	1.2 - 1.5 (10.6 - 13.3)
4007	R/L1, S/L2, T/L3	2.5	2.5 - 10 (2.5 - 10)	10	M4	Slotted (-)	1.5 - 1.7 (13.5 - 15)
	U/T1, V/T2, W/T3	2.5	2.5 - 10 (2.5 - 10)	10	M4	Slotted (-)	1.5 - 1.7 (13.5 - 15)
	-, +1, +2	2.5	2.5 - 16 (2.5 - 16)	18	M5	Slotted (-)	2.3 - 2.5 (19.8 - 22) <sup>*3</sup>
	B1, B2	2.5	2.5 - 4 (2.5 - 4)	10	M4	Slotted (-)	1.5 - 1.7 (13.5 - 15)
	⊕	2.5 <sup>*4</sup>	2.5 - 10 (-)	-	M4	Phillips/slotted combo	1.2 - 1.5 (10.6 - 13.3)



Model	Terminals	Recommended Gauge mm <sup>2</sup>	Applicable Gauge (IP20 Applicable Gauge <sup>*1</sup> ) mm <sup>2</sup>	Wire Stripping Length <sup>*2</sup> mm	Terminal Screw		Tightening Torque N·m (lb·in.)
					Size	Shape	
4009	R/L1, S/L2, T/L3	2.5	2.5 - 10 (2.5 - 10)	10	M4	Slotted (-)	1.5 - 1.7 (13.5 - 15)
	U/T1, V/T2, W/T3	2.5	2.5 - 10 (2.5 - 10)	10	M4	Slotted (-)	1.5 - 1.7 (13.5 - 15)
	-, +1, +2	2.5	2.5 - 16 (2.5 - 16)	18	M5	Slotted (-)	2.3 - 2.5 (19.8 - 22) <sup>*3</sup>
	B1, B2	2.5	2.5 - 4 (2.5 - 4)	10	M4	Slotted (-)	1.5 - 1.7 (13.5 - 15)
	⊕	2.5 <sup>*4</sup>	2.5 - 10 (-)	-	M4	Phillips/slotted combo	1.2 - 1.5 (10.6 - 13.3)
4012	R/L1, S/L2, T/L3	2.5	2.5 - 10 (2.5 - 10)	10	M4	Slotted (-)	1.5 - 1.7 (13.5 - 15)
	U/T1, V/T2, W/T3	2.5	2.5 - 10 (2.5 - 10)	10	M4	Slotted (-)	1.5 - 1.7 (13.5 - 15)
	-, +1, +2	2.5	2.5 - 16 (2.5 - 16)	18	M5	Slotted (-)	2.3 - 2.5 (19.8 - 22) <sup>*3</sup>
	B1, B2	2.5	2.5 - 4 (2.5 - 4)	10	M4	Slotted (-)	1.5 - 1.7 (13.5 - 15)
	⊕	2.5 <sup>*4</sup>	2.5 - 10 (-)	-	M4	Phillips/slotted combo	1.2 - 1.5 (10.6 - 13.3)
4018	R/L1, S/L2, T/L3	2.5	2.5 - 10 (2.5 - 10)	10	M4	Slotted (-)	1.5 - 1.7 (13.5 - 15)
	U/T1, V/T2, W/T3	2.5	2.5 - 10 (2.5 - 10)	10	M4	Slotted (-)	1.5 - 1.7 (13.5 - 15)
	-, +1, +2	4	2.5 - 16 (2.5 - 16)	18	M5	Slotted (-)	2.3 - 2.5 (19.8 - 22) <sup>*3</sup>
	B1, B2	2.5	2.5 - 4 (2.5 - 4)	10	M4	Slotted (-)	1.5 - 1.7 (13.5 - 15)
	⊕	2.5 <sup>*4</sup>	2.5 - 10 (-)	-	M5	Phillips/slotted combo	2.0 - 2.5 (17.7 - 22.1)
4023	R/L1, S/L2, T/L3	6	2.5 - 10 (2.5 - 10)	10	M4	Slotted (-)	1.5 - 1.7 (13.5 - 15)
	U/T1, V/T2, W/T3	4	2.5 - 10 (2.5 - 10)	10	M4	Slotted (-)	1.5 - 1.7 (13.5 - 15)
	-, +1, +2	6	2.5 - 16 (2.5 - 16)	18	M5	Slotted (-)	2.3 - 2.5 (19.8 - 22) <sup>*3</sup>
	B1, B2	2.5	2.5 - 4 (2.5 - 4)	10	M4	Slotted (-)	1.5 - 1.7 (13.5 - 15)
	⊕	6 <sup>*4</sup>	4 - 10 (-)	-	M5	Phillips/slotted combo	2.0 - 2.5 (17.7 - 22.1)

## 2.12 Main Circuit Wiring

Model	Terminals	Recommended Gauge mm <sup>2</sup>	Applicable Gauge (IP20 Applicable Gauge <sup>*/</sup> ) mm <sup>2</sup>	Wire Stripping Length <sup>*2</sup> mm	Terminal Screw		Tightening Torque N·m (lb·in.)
					Size	Shape	
4031	R/L1, S/L2, T/L3	10	2.5 - 25 (10 - 25)	18	M5	Slotted (-)	2.3 - 2.5 (19.8 - 22) <sup>*3</sup>
	U/T1, V/T2, W/T3	6	2.5 - 16 (6 - 16)	18	M5	Slotted (-)	2.3 - 2.5 (19.8 - 22) <sup>*3</sup>
	-, +1, +2	10	2.5 - 35 (10 - 35)	20	M6	Hex socket cap (WAF: 5 mm)	5 - 5.5 (45 - 49)
	B1, B2	2.5	2.5 - 10 (2.5 - 10)	10	M4	Slotted (-)	1.5 - 1.7 (13.5 - 15)
	⊕	10	6 - 16 (-)	-	M6	Phillips/slotted combo	5.4 - 6.0 (47.8 - 53.1)
4038	R/L1, S/L2, T/L3	10	2.5 - 25 (10 - 25)	18	M5	Slotted (-)	2.3 - 2.5 (19.8 - 22) <sup>*3</sup>
	U/T1, V/T2, W/T3	6	2.5 - 16 (6 - 16)	18	M5	Slotted (-)	2.3 - 2.5 (19.8 - 22) <sup>*3</sup>
	-, +1, +2	16	2.5 - 35 (10 - 35)	20	M6	Hex socket cap (WAF: 5 mm)	5 - 5.5 (45 - 49)
	B1, B2	4	2.5 - 10 (2.5 - 10)	10	M4	Slotted (-)	1.5 - 1.7 (13.5 - 15)
	⊕	10	6 - 16 (-)	-	M6	Phillips/slotted combo	5.4 - 6.0 (47.8 - 53.1)
4044	R/L1, S/L2, T/L3	16	2.5 - 16 (4 - 16)	18	M5	Slotted (-)	2.3 - 2.5 (19.8 - 22) <sup>*3</sup>
	U/T1, V/T2, W/T3	10	2.5 - 10 (6 - 10)	18	M5	Slotted (-)	2.3 - 2.5 (19.8 - 22) <sup>*3</sup>
	-, +1, +2	25	2.5 - 25 (6 - 25)	18	M5	Slotted (-)	2.3 - 2.5 (19.8 - 22) <sup>*3</sup>
	B1, B2	6	2.5 - 6 (2.5 - 6)	10	M4	Slotted (-)	1.5 - 1.7 (13.5 - 15)
	⊕	16	10 - 25 (-)	-	M6	Phillips/slotted combo	5.4 - 6.0 (47.8 - 53.1)
4060	R/L1, S/L2, T/L3	16	2.5 - 16 (4 - 16)	18	M5	Slotted (-)	2.3 - 2.5 (19.8 - 22) <sup>*3</sup>
	U/T1, V/T2, W/T3	16	2.5 - 16 (6 - 16)	18	M5	Slotted (-)	2.3 - 2.5 (19.8 - 22) <sup>*3</sup>
	-, +1	25	2.5 - 25 (6 - 25)	18	M5	Slotted (-)	2.3 - 2.5 (19.8 - 22) <sup>*3</sup>
	B1, B2	10	2.5 - 10 (2.5 - 10)	10	M4	Slotted (-)	1.5 - 1.7 (13.5 - 15)
	⊕	16	10 - 25 (-)	-	M6	Phillips/slotted combo	5.4 - 6.0 (47.8 - 53.1)

Model	Terminals	Recommended Gauge mm <sup>2</sup>	Applicable Gauge (IP20 Applicable Gauge <sup>*1</sup> ) mm <sup>2</sup>	Wire Stripping Length <sup>*2</sup> mm	Terminal Screw		Tightening Torque N·m (lb·in.)
					Size	Shape	
4075	R/L1, S/L2, T/L3	25	2.5 - 25 (2.5 - 25)	18	M5	Slotted (-)	2.3 - 2.5 (19.8 - 22) <sup>*3</sup>
	U/T1, V/T2, W/T3	25	2.5 - 25 (2.5 - 25)	18	M5	Slotted (-)	2.3 - 2.5 (19.8 - 22) <sup>*3</sup>
	-, +1	25	2.5 - 25 (4 - 25)	18	M5	Slotted (-)	2.3 - 2.5 (19.8 - 22) <sup>*3</sup>
	B1, B2	10	2.5 - 10 (2.5 - 10)	10	M4	Slotted (-)	1.5 - 1.7 (13.5 - 15)
	⊕	16	16 - 25 (-)	-	M6	Hex bolt (+)	5.4 - 6.0 (47.8 - 53.1)
4089	R/L1, S/L2, T/L3	25	2.5 - 25 (10 - 25)	18	M5	Slotted (-)	2.3 - 2.5 (19.8 - 22) <sup>*3</sup>
	U/T1, V/T2, W/T3	25	2.5 - 25 (10 - 25)	18	M5	Slotted (-)	2.3 - 2.5 (19.8 - 22) <sup>*3</sup>
	-, +1	35	2.5 - 35 (16 - 35)	20	M6	Hex socket cap (WAF: 5 mm)	5 - 5.5 (45 - 49)
	B1, B2	16	2.5 - 16 (4 - 16)	18	M5	Slotted (-)	2.3 - 2.5 (19.8 - 22) <sup>*3</sup>
	⊕	16	16 - 25 (-)	-	M6	Hex bolt (+)	5.4 - 6.0 (47.8 - 53.1)
4103	R/L1, S/L2, T/L3	35	16 - 50 (50)	27	M6	Hex socket cap (WAF: 5 mm)	8 - 9 (71 - 80)
	U/T1, V/T2, W/T3	35	16 - 50 (50)	27	M6	Hex socket cap (WAF: 5 mm)	8 - 9 (71 - 80)
	-, +1	50	25 - 70 (50 - 70)	27	M8	Hex socket cap (WAF: 6 mm)	10 - 12 (89 - 107)
	B1, B2	25	6 - 35 (6 - 35)	21	M6	Minus (-)	3 - 3.5 (27 - 31)
	⊕	16	16 - 25 (-)	-	M6	Hex bolt (+)	5.4 - 6.0 (47.8 - 53.1)
4140	R/L1, S/L2, T/L3	50	50 - 95 (95)	37	M10	Hex socket cap (WAF: 8 mm)	12 - 14 (107 - 124)
	U/T1, V/T2, W/T3	50	50 - 95 (95)	37	M10	Hex socket cap (WAF: 8 mm)	12 - 14 (107 - 124)
	-, -, +1, +1 <sup>*5</sup>	25	16 - 50 (50)	28	M6	Hex socket cap (WAF: 5 mm)	8 - 9 (71 - 80)
	B1, B2 <sup>*6</sup>	50	25 - 70 (50 - 70)	28	M8	Hex socket cap (WAF: 6 mm)	8 - 9 (71 - 80)
	⊕	25	25 - 50 (-)	-	M8	Hex bolt (slotted)	9.0 - 11 (79.7 - 97.4)

## 2.12 Main Circuit Wiring

Model	Terminals	Recommended Gauge mm <sup>2</sup>	Applicable Gauge (IP20 Applicable Gauge <sup>*1</sup> ) mm <sup>2</sup>	Wire Stripping Length <sup>*2</sup> mm	Terminal Screw		Tightening Torque N·m (lb·in.)
					Size	Shape	
4168	R/L1, S/L2, T/L3	70	50 - 95 (95)	37	M10	Hex socket cap (WAF: 8 mm)	12 - 14 (107 - 124)
	U/T1, V/T2, W/T3	70	50 - 95 (95)	37	M10	Hex socket cap (WAF: 8 mm)	12 - 14 (107 - 124)
	-, -, +1, +1 <sup>*5</sup>	35	16 - 50 (50)	28	M6	Hex socket cap (WAF: 5 mm)	8 - 9 (71 - 80)
	B1, B2 <sup>*6</sup>	50	25 - 70 (50 - 70)	28	M8	Hex socket cap (WAF: 6 mm)	8 - 9 (71 - 80)
	⊕	35	25 - 50 (-)	-	M8	Hex bolt (slotted)	9.0 - 11 (79.7 - 97.4)
4208	R/L1, S/L2, T/L3	50 × 2P	25 - 95 × 2P (70 - 95 × 2P)	-	M10	Hex self-locking nut	20 (177)
	U/T1, V/T2, W/T3	50 × 2P	25 - 95 × 2P (70 - 95 × 2P)	-	M10	Hex self-locking nut	20 (177)
	-, +1	70 × 2P	35 - 120 × 2P (120 × 2P)	-	M10	Hex self-locking nut	20 (177)
	+3	35 × 2P	25 - 70 × 2P (70 × 2P)	-	M10	Hex self-locking nut	20 (177)
	⊕	50	50 - 240 (-)	-	M10	Hex bolt (slotted)	18 - 23 (159 - 204)
4250	R/L1, S/L2, T/L3	50 × 2P	25 - 95 × 2P (70 - 95 × 2P)	-	M10	Hex self-locking nut	20 (177)
	U/T1, V/T2, W/T3	50 × 2P	25 - 95 × 2P (70 - 95 × 2P)	-	M10	Hex self-locking nut	20 (177)
	-, +1	70 × 2P	35 - 120 × 2P (120 × 2P)	-	M10	Hex self-locking nut	20 (177)
	+3	50 × 2P	25 - 70 × 2P (70 × 2P)	-	M10	Hex self-locking nut	20 (177)
	⊕	70	70 - 240 (-)	-	M10	Hex bolt (slotted)	18 - 23 (159 - 204)
4296	R/L1, S/L2, T/L3	70 × 2P	25 - 95 × 2P (70 - 95 × 2P)	-	M10	Hex self-locking nut	20 (177)
	U/T1, V/T2, W/T3	70 × 2P	25 - 95 × 2P (70 - 95 × 2P)	-	M10	Hex self-locking nut	20 (177)
	-, +1	95 × 2P	35 - 120 × 2P (120 × 2P)	-	M10	Hex self-locking nut	20 (177)
	+3	70 × 2P	25 - 70 × 2P (70 × 2P)	-	M10	Hex self-locking nut	20 (177)
	⊕	95	95 - 240 (-)	-	M10	Hex bolt (slotted)	18 - 23 (159 - 204)

Model	Terminals	Recommended Gauge mm <sup>2</sup>	Applicable Gauge (IP20 Applicable Gauge *) mm <sup>2</sup>	Wire Stripping Length *2 mm	Terminal Screw		Tightening Torque N·m (lb·in.)
					Size	Shape	
4371	R/L1, S/L2, T/L3	120 × 2P	70 - 150 × 2P (150 × 2P)	-	M12	Hex self-locking nut	35 (310)
	U/T1, V/T2, W/T3	120 × 2P	70 - 150 × 2P (150 × 2P)	-	M12	Hex self-locking nut	35 (310)
	-, +1	120 × 2P	95 - 185 × 2P (185 × 2P)	-	M12	Hex self-locking nut	35 (310)
	+3	70 × 2P	50 - 95 × 2P (-)	-	M12	Hex self-locking nut	35 (310)
	⊕	120	120 - 240 (-)	-	M12	Hex bolt (slotted)	32 - 40 (283 - 354)
4389	R/L1, S/L2, T/L3	120 × 2P	70 - 150 × 2P (150 × 2P)	-	M12	Hex self-locking nut	35 (310)
	U/T1, V/T2, W/T3	120 × 2P	70 - 150 × 2P (150 × 2P)	-	M12	Hex self-locking nut	35 (310)
	-, +1	120 × 2P	95 - 185 × 2P (185 × 2P)	-	M12	Hex self-locking nut	35 (310)
	+3	95 × 2P	50 - 95 × 2P (-)	-	M12	Hex self-locking nut	35 (310)
	⊕	95	35 - 240 (-)	-	M12	Hex bolt (slotted)	32 - 40 (283 - 354)
4453	R/L1, S/L2, T/L3 R1/L11, S1/L21, T1/L31	120 × 4P	70 - 150 × 4P (150 × 4P)	-	M12	Hex self-locking nut	35 (310)
	U/T1, V/T2, W/T3	95 × 4P	70 - 150 × 4P (120 - 150 × 4P)	-	M12	Hex self-locking nut	35 (310)
	-, +1	95 × 4P	95 - 185 × 4P (185 × 4P)	-	M12	Hex self-locking nut	35 (310)
	+3	70 × 4P	35 - 95 × 4P (95 × 4P)	-	M12	Hex self-locking nut	35 (310)
	⊕	150	50 - 150 (-)	-	M12	Hex bolt (slotted)	32 - 40 (283 - 354)
4568	R/L1, S/L2, T/L3 R1/L11, S1/L21, T1/L31	120 × 4P	70 - 150 × 4P (150 × 4P)	-	M12	Hex self-locking nut	35 (310)
	U/T1, V/T2, W/T3	95 × 4P	70 - 150 × 4P (120 - 150 × 4P)	-	M12	Hex self-locking nut	35 (310)
	-, +1	95 × 4P	95 - 185 × 4P (185 × 4P)	-	M12	Hex self-locking nut	35 (310)
	+3	70 × 4P	35 - 95 × 4P (95 × 4P)	-	M12	Hex self-locking nut	35 (310)
	⊕	95 × 2P	60 - 150 (-)	-	M12	Hex bolt (slotted)	32 - 40 (283 - 354)

Model	Terminals	Recommended Gauge mm <sup>2</sup>	Applicable Gauge (IP20 Applicable Gauge <sup>*1</sup> ) mm <sup>2</sup>	Wire Stripping Length <sup>*2</sup> mm	Terminal Screw		Tightening Torque N·m (lb·in.)
					Size	Shape	
4675	R/L1, S/L2, T/L3 R1/L11, S1/L21, T1/L31	120 × 4P	70 - 150 × 4P (150 × 4P)	-	M12	Hex self-locking nut	35 (310)
	U/T1, V/T2, W/T3	95 × 4P	70 - 150 × 4P (120 - 150 × 4P)	-	M12	Hex self-locking nut	35 (310)
	-, +1	95 × 4P	95 - 185 × 4P (185 × 4P)	-	M12	Hex self-locking nut	35 (310)
	+3	70 × 4P	35 - 95 × 4P (95 × 4P)	-	M12	Hex self-locking nut	35 (310)
	⊕	95 × 2P	60 - 150 (-)	-	M12	Hex bolt (slotted)	32 - 40 (283 - 354)

- \*1 For IP20 protection, use wires that are in the range of applicable gauges.
- \*2 Remove insulation from the ends of wires to expose the length of wire shown.
- \*3 For wire gauges more than 30 mm<sup>2</sup>, tighten to a tightening torque of 4.1 N·m to 4.5 N·m (36 lb·in. to 40 lb·in.).
- \*4 Install an RCM/RCD with this wire gauge to maintain compliance with IEC/EN 61800-5-1:2007.
- \*5 Terminals - and +1 have two screws. The Recommended Gauge is the wire gauge for one terminal.
- \*6 A junction terminal is necessary to connect a braking resistor unit (LKEB-series) to terminals B1 and B2.

### ◆ Main Circuit Terminal and Motor Wiring

This section outlines the various steps, precautions, and checkpoints for wiring the main circuit terminals and motor terminals.

**WARNING!** *Electrical Shock Hazard. Do not connect the AC power line to the output terminals of the drive. Failure to obey can cause death or serious injury by fire.*

**NOTICE:** *Make sure that you align the phase order for the drive and motor when you connect the motor to drive output terminals U/T1, V/T2, and W/T3. Failure to obey correct wiring procedures can cause the motor to run in reverse if the phase order is incorrect.*

**NOTICE:** *Do not connect phase-advancing capacitors or LC/RC noise filters to the output circuits. Failure to obey can cause damage to the drive, phase-advancing capacitors, LC/RC noise filters, and leakage breakers (ELCB, GFCI, or RCM/RCD).*

### ■ Cable Length Between Drive and Motor

When the wiring between the drive and the motor is too long, voltage drop along the motor cable can decrease motor torque, usually at low frequency output. If you connect motors in parallel with long motor cable, this is also a problem. Drive output current increases when the leakage current from the cable increases. An increase in leakage current can cause overcurrent and decrease the precision of the current detection.

Use the values in [Table 2.17](#) to adjust the drive carrier frequency. When the system configuration makes the motor wiring distance more than 100 m (328 ft), do not use metal conduits or use isolated cables for each phase to decrease stray capacitance.

**Table 2.17 Carrier Frequency against Cable Length Between Drive and Motor**

Cable Length Between Drive and Motor	Up to 50 m (164 ft.)	Up to 100 m (328 ft.)	More than 100 m (328 ft.)
Carrier Frequency	15 kHz or less	5 kHz or less	2 kHz or less

**Note:**

- To set the carrier frequency in a drive that is operating more than one motor, calculate the cable length as the total distance of wiring to all connected motors.
- IN OLV/PM and AOLV/PM [*A1-02 = 5 and 6*], the maximum cable length is 100 m (328 ft.).
- When you connect to a PM motor, it can be necessary to adjust the overcurrent detection. Refer to [L8-27: Overcurrent Detection Gain on page 982](#) for more information.

### ■ Ground Wiring

Follow the precautions to wire the ground for one drive or a series of drives.

**WARNING! Electrical Shock Hazard.** Make sure that the protective ground wire complies with technical standards and local safety regulations. The leakage current of the drive will be more than 3.5 mA in drive models 2xxxB, 2xxxC, 4002B to 4371B, 4002C to 4371C (with EMC filter turned ON) and 4389 to 4675. The IEC/EN 61800-5-1:2007 standard specifies that you must wire the power supply to automatically turn off when the protective ground wire disconnects. You can also connect a protective ground wire that has a minimum cross-sectional area of 10mm<sup>2</sup> (copper wire) or 16 mm<sup>2</sup> (aluminum wire). Failure to obey these standards can cause death or serious injury.

**WARNING! Electrical Shock Hazard.** Ground the neutral point on the power supply of drive models 2xxxB/C and 4xxxA/B/C to comply with the EMC Directive before turning on the EMC filter or if there is high resistance grounding. If the EMC filter is switched ON without the neutral point being grounded or if there is high resistance grounding, it can cause death or serious injury.

**WARNING! Electrical Shock Hazard.** Use a ground wire that complies with technical standards on electrical equipment and use the minimum length of ground wire. Incorrect equipment grounding can cause serious injury or death from dangerous electrical potentials on the equipment chassis.

**WARNING! Electrical Shock Hazard.**

Correctly ground the ground terminals. Obey federal and local electrical wiring codes for correct grounding methods.

- 200 V class: ground to 100  $\Omega$  or less
- 400 V class: ground to 10  $\Omega$  or less

Failure to obey can cause death or serious injury from contacting ungrounded electrical equipment.

**NOTICE:** Do not share the ground wire with other devices, for example welding machines or large-current electrical equipment. Incorrect equipment grounding can cause drive or equipment malfunction from electrical interference.

**NOTICE:** To use more than one drive, obey the instructions to ground all drives. Incorrect equipment grounding can cause incorrect operation of drives and equipment.

Refer to [Figure 2.83](#) when connecting more than one drive. Do not loop the grounding wire.

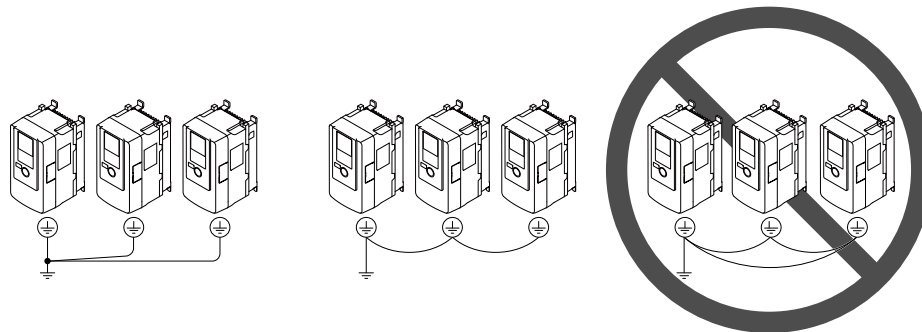


Figure 2.83 Wiring More than One Drive

## ■ Wiring the Main Circuit Terminal Block

**WARNING! Electrical Shock Hazard.** De-energize the drive and correctly ground the terminal board before you wire the main circuit terminals. Failure to obey can cause death or serious injury.

## ■ Main Circuit Configuration

The figures in this section show the different schematics of the drive main circuit. The connections change when the drive capacity changes. The DC power supply for the main circuit also supplies power to the control circuit.

**Note:**

Drive models 2004A to 2415A and 4002A to 4675A do not have a built-in EMC filter.

**WARNING! Fire Hazard.** The braking resistor connection terminals are B1 and B2. Do not connect braking resistors to other terminals. Incorrect wiring connections could cause the braking resistor to overheat. Failure to obey can cause death or serious injury by fire and damage to the drive and braking circuit.

**NOTICE:** Do not use the negative DC bus terminal “-” as a ground terminal. This terminal is at high DC voltage potential. Incorrect wiring connections could cause damage to the drive.

Model	Figure
2004 to 2082, 4002 to 4044	<a href="#">Figure 2.84</a>
2110 to 2138, 4060 to 4168	<a href="#">Figure 2.85</a>
2169 to 2313, 4208 to 4250	<a href="#">Figure 2.86</a>
2360 to 2415, 4296 to 4675	<a href="#">Figure 2.87</a>

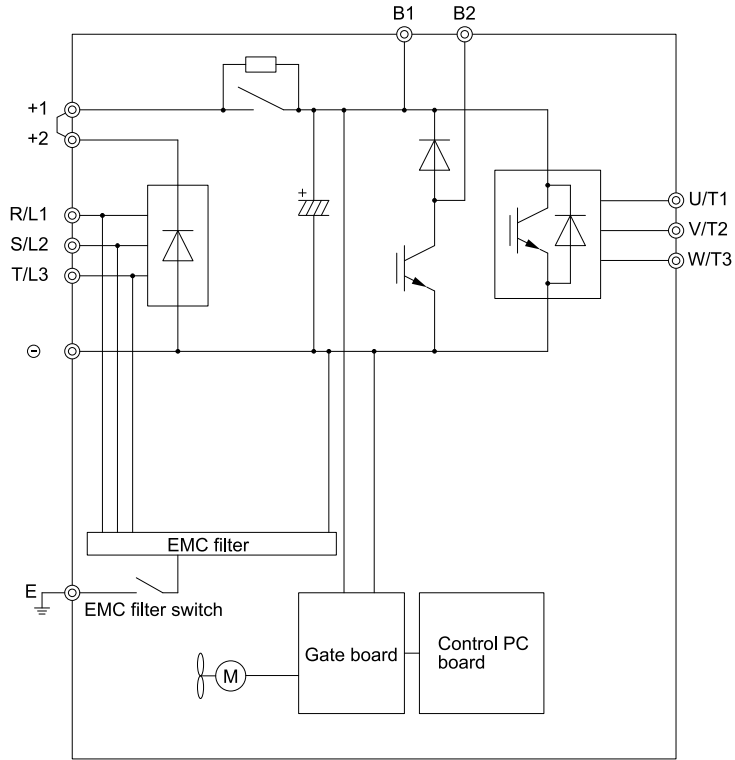


Figure 2.84 Drive Main Circuit Configuration

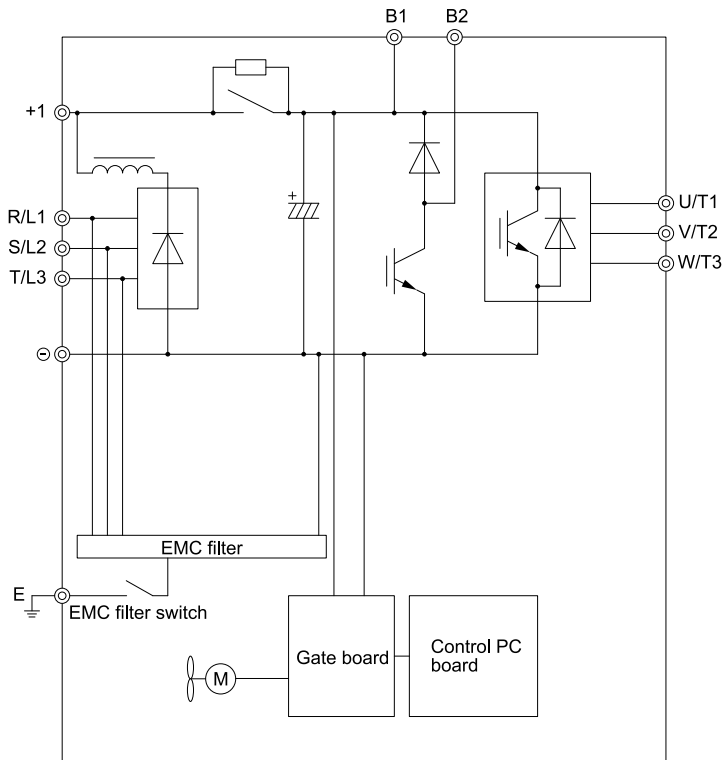


Figure 2.85 Drive Main Circuit Configuration



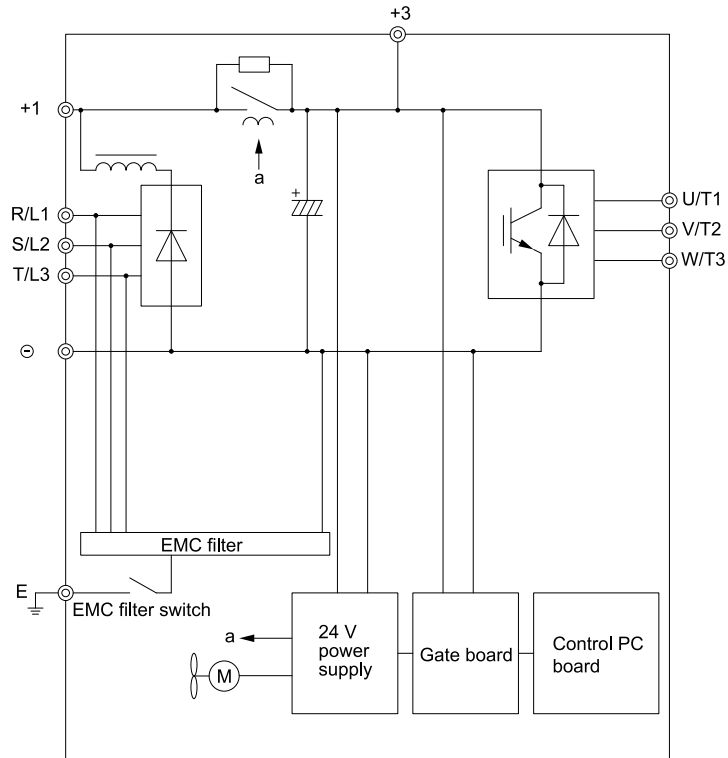


Figure 2.86 Drive Main Circuit Configuration

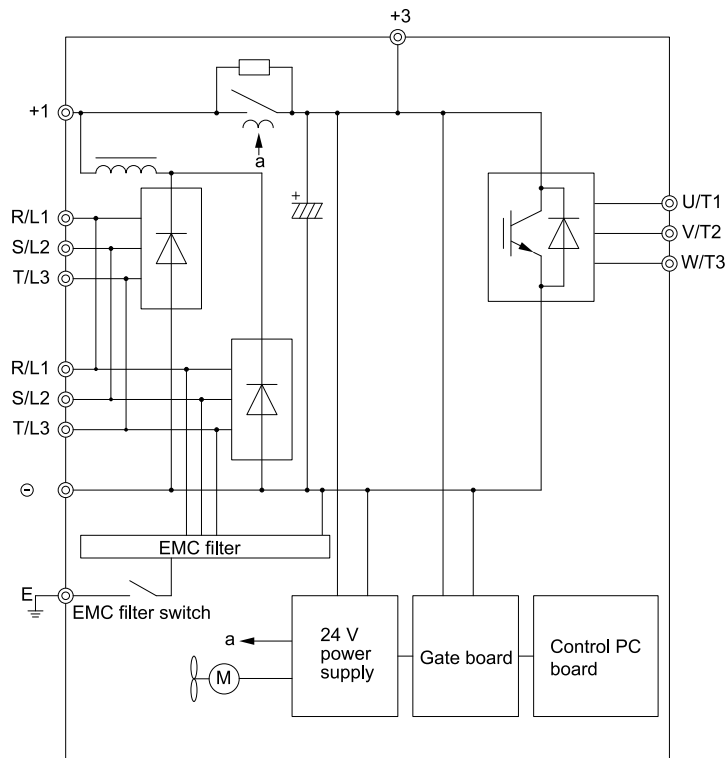


Figure 2.87 Drive Main Circuit Configuration

### ◆ Protection of Main Circuit Terminals

When wiring the main circuit terminals, do not let cable ends go near terminals or the drive. If you use crimped terminals, make sure that you also use insulation caps.

## 2.13 Main Circuit Terminal Block Wiring Procedure

**DANGER!** *Electrical Shock Hazard. Do not examine, connect, or disconnect wiring on an energized drive. Before servicing, disconnect all power to the equipment and wait for the time specified on the warning label at a minimum. The internal capacitor stays charged after the drive is de-energized. The charge indicator LED extinguishes when the DC bus voltage decreases below 50 Vdc. When all indicators are OFF, remove the covers before measuring for dangerous voltages to make sure that the drive is safe. Failure to obey will cause death or serious injury.*

The procedures to wire the main circuit terminal block are different for different drive models. Refer to [Table 2.18](#) for model numbers and procedures.

**Table 2.18 Types of Wiring Procedure for the Main Circuit Terminal Block**

Model	Procedure	Reference
2004 - 2211 4002 - 4168	Procedure A	98
2257 - 2415 4208 - 4675	Procedure B	101

### ◆ Wiring the Main Circuit Terminal Block Using Procedure A

Wire the main circuit terminal block correctly as specified by the instructions in the manual.

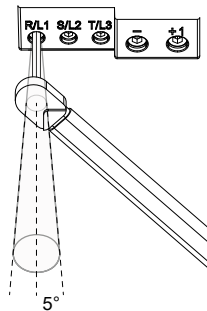
Read these instructions before wiring the terminal block.

### ■ Notes on Wiring the Main Circuit Terminal Block

Read these notes before you wire the main circuit terminal block.

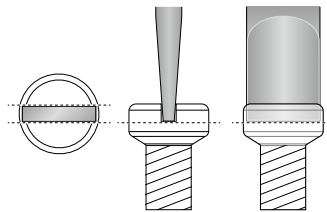
**Note:**

- Use UL-Listed, vinyl-coated insulated copper wires for operation with a continuous maximum permitted temperature of 75 °C at 600 V
- Remove all unwanted objects that are near the terminal block connections.
- Remove the insulation from the connection wires to the wire stripping lengths shown in the manual.
- Do not use bent or crushed wires. Remove the damaged end of the wire before you use it. Incorrect connections can cause death or serious injury from fire.
- Do not solder stranded wire. Soldered wire connections can become loose over time and cause unsatisfactory drive performance.
- If you use stranded wire, make sure that all of the wire strands are in the connection. Also, do not twist the stranded wire too much. Incorrect connections can cause death or serious injury from fire.
- Put the wire all the way into the terminal block. Remove the insulation from the wire to the recommended wire stripping length to fit the wire with insulation in the plastic housing.
- Use a torque driver, torque ratchet, or torque wrench for the screws. A slotted driver or a hex tool will be necessary to wire the screw clamp terminal. Use applicable tools as specified by the recommended conditions in the product manual.
- If you use power tools to tighten the terminal screws, use a low speed setting (300 to 400 r/min). Failure to obey can cause damage to the terminal screws.
- Users can purchase wiring tools from Yaskawa. Contact Yaskawa or your nearest sales representative for more information.
- Wire gauges on existing drive models to be replaced may not match wire gauge ranges on new drives. Contact Yaskawa or your nearest sales representative for wire gauges that you can and cannot use.
- Do not tighten the terminal screws at an angle of 5 degrees or more. Failure to obey can cause damage to the terminal screws.



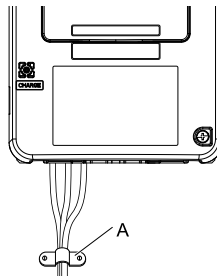
**Figure 2.88 Permitted Angle**

- Put the bit all the way into the hex socket to tighten the hex socket cap screw.
- When tightening slotted screws, hold the straight-edge screwdriver perpendicularly to the screw. Do not allow the tip of the screwdriver to shift or protrude from the groove of the screw.



**Figure 2.89 Tightening Slotted Screws**

- After connecting the wires to the terminal block, lightly pull on the wires to make sure that they do not come out of the terminals.
- Remove the correct section of the wiring cover to make wiring easier.
- Do not let strain on the wiring cause damage. Use a strain relief near the wiring to release the tension. Refer to [Figure 2.90](#) for an example.



**A - Strain relief**

**Figure 2.90 Strain Relief Example**

Table 2.19 Recommended Wiring Tools

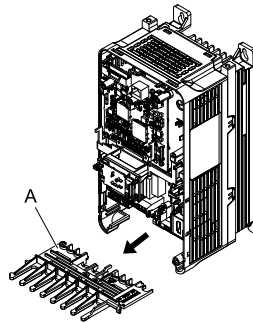
Screw Size	Screw Shape	Adapter	Bit		Torque Driver Model (Tightening Torque)	Torque Wrench
			Model	Manufacturer		
M4	Slotted (-)	Bit	SF-BIT-SL 1,0X4,0-70	PHOENIX CONTACT	TSD-M 3NM (1.2 - 3 N·m)	-
M5 *1	Slotted (-)	Bit	SF-BIT-SL 1,2X6,5-70	PHOENIX CONTACT	Wire Gauge ≤ 25 mm <sup>2</sup> (AWG 10): TSD-M 3NM (1.2 - 3 N·m)	Wire Gauge ≤ 25 mm <sup>2</sup> (AWG 10): -
					Wire Gauge ≥ 30 mm <sup>2</sup> (AWG 8): -	Wire Gauge ≥ 30 mm <sup>2</sup> (AWG 8): 4.1 - 4.5 N·m *2 *3
M6	Hex socket cap (WAF: 5 mm)	Bit	SF-BIT-HEX 5-50	PHOENIX CONTACT	-	5 - 9 N·m *2 *3
	Slotted (-)	Bit	SF-BIT-SL 1,2X6,5-70	PHOENIX CONTACT	-	3 - 3.5 N·m *2 *3
M8	Hex socket cap (WAF: 6 mm)	Bit	SF-BIT-HEX 6-50	PHOENIX CONTACT	-	8 - 12 N·m *2 *3
M10	Hex socket cap (WAF: 8 mm)	Bit	SF-BIT-HEX 8-50	PHOENIX CONTACT	-	12 - 14 N·m *2 *3

\*1 When wiring drive models 2056 and 4089 and smaller, select the correct tools for the wire gauge.  
 \*2 Use 6.35 mm (0.25 in) bit socket holder.  
 \*3 Use a torque wrench that can apply this torque measurement range.

■ Main Circuit Terminal Block Wiring Procedure

Remove the keypad and front cover before wiring the main circuit terminal block.

1. Pull the wiring cover forward to remove it from the drive.



A - Wiring cover

Figure 2.91 Remove the Wiring Cover

2. Put the end of a prepared wire into the terminal block.

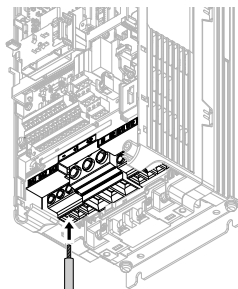
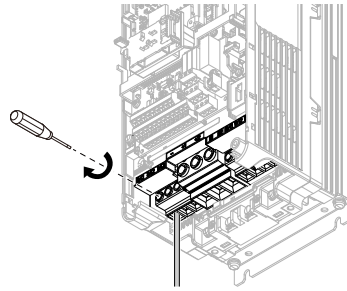


Figure 2.92 Install the Electrical Wire

**Note:**

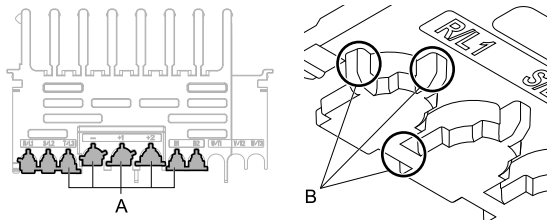
If there is a jumper between terminals +1 and +2, loosen the terminal block screws and remove the jumper before wiring the terminals.

3. Tighten the screws to the specified torque.



**Figure 2.93 Tighten Terminal Block Screws**

4. Check the signal from the wired terminal and use a diagonal-cutting pliers to remove areas of the wiring cover cutaway section.  
Cut the areas shown in [Figure 2.94](#).



**A - Cutaway section**

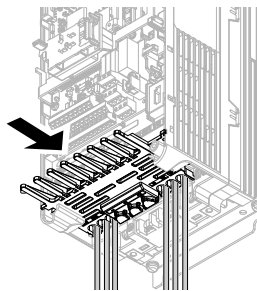
**B - Use a diagonal-cutting pliers to clip this area.**

**Figure 2.94 Clip the Cutaway Section of the Wiring Cover**

**Note:**

- Different drive models have different wiring cover shapes.
- Remove only the areas from the wiring cover that apply to the wired terminal. The drive will not keep its IP20 protective level if areas that do not apply to the wired terminal are removed.
- Tightly hold the cutaway section when removing pieces of the cutaway section. Pieces of the cutaway section can fly out and cause injury.
- Remove sharp edges from the wiring cover cutaway section to prevent damage to the wires.
- The drive might not keep its IP20 protective level if wires other than those specified by Yaskawa are used, even if the wiring cover is used correctly. Contact Yaskawa or your nearest sales representative for more information.

5. Install the wiring cover to its initial position. Put the cables through the holes cut from the wiring cover.



**Figure 2.95 Reattach the Wiring Cover**

6. Install the front cover and the keypad to their initial positions.

## ◆ Wiring the Main Circuit Terminal Block Using Procedure B

Wire the main circuit terminal block correctly as specified by the instructions in the manual.  
Read these instructions before wiring the terminal block.

■ **Notes on Wiring the Main Circuit Terminal Block**

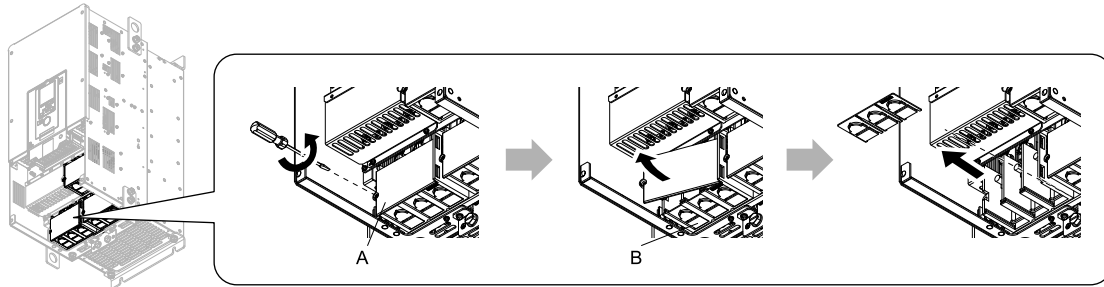
**Note:**

- Do not shake the electrical wire too much.
- Be sure to use only wires with the correct size, stripped wire length, and tightening torque as specified by Yaskawa.
- Use tools that fit the shape of the screw head to tighten and loosen the terminal block screws.
- Make sure that there are no loose stranded wires or frayed wires after wiring is complete.

■ **Main Circuit Terminal Block Wiring Procedure**

Remove the terminal cover before wiring the main circuit terminal block.

1. Remove the screws on the terminal block cover and pull the terminal block cover away from the drive. Pull the wiring cover away from the drive to remove the wiring cover after removing the terminal block cover.

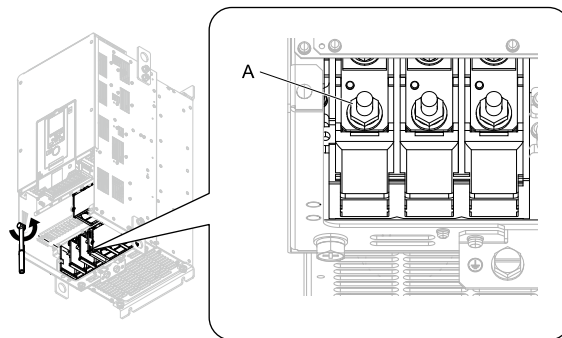


A - Terminal block cover

B - Wiring cover

Figure 2.96 Remove the Wiring Cover

2. Remove the terminal block nut.



A - Nut

Figure 2.97 Remove the Terminal Block Nut

3. Wire the closed-loop crimp terminal to the main circuit terminal block.

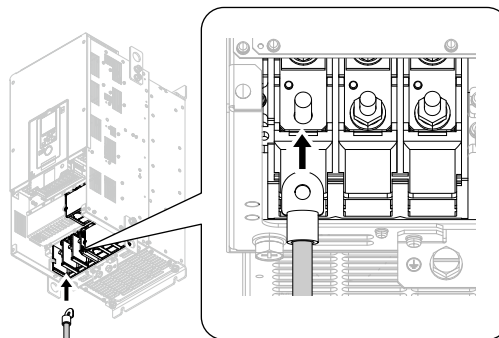
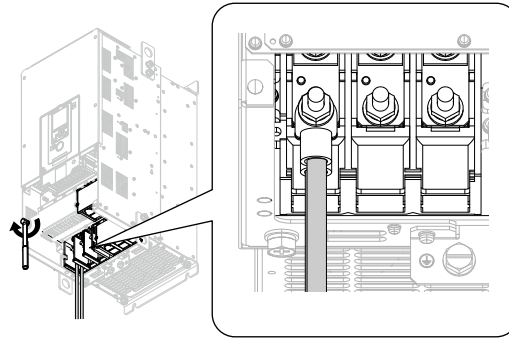


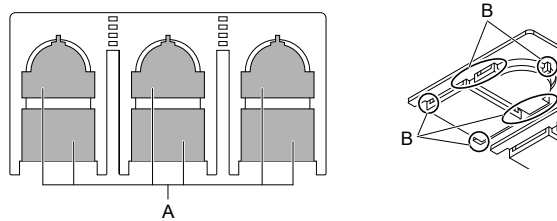
Figure 2.98 Install the Electrical Wire

4. Tighten the nut to the specified torque.



**Figure 2.99 Tighten the Terminal Block Nut**

5. Check the signal from the wired terminal and use a diagonal-cutting pliers to remove areas of the wiring cover cutaway section. Cut the areas shown in [Figure 2.100](#).



**A - Cutaway section**

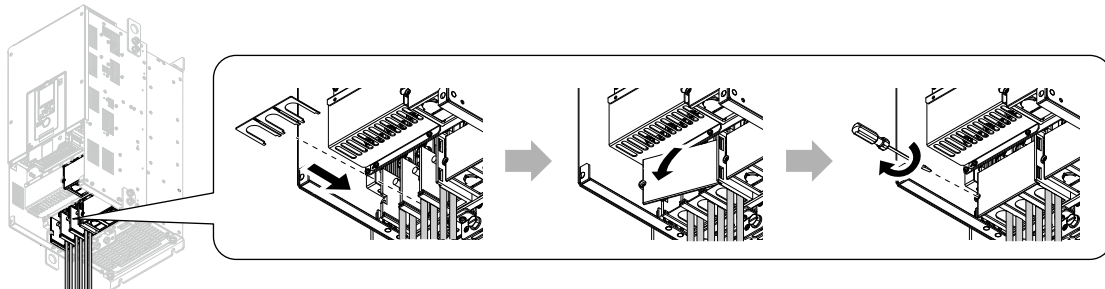
**B - Use a diagonal-cutting pliers to clip this area.**

**Figure 2.100 Clip the Cutaway Section of the Wiring Cover**

**Note:**

- Different drive models have different wiring cover shapes.
- Remove only the areas from the wiring cover that apply to the wired terminal. The drive will not keep its IP20 protective level if areas that do not apply to the wired terminal are removed.
- Tightly hold the cutaway section when removing pieces of the cutaway section. Pieces of the cutaway section can fly out and cause injury.
- Remove sharp edges from the wiring cover cutaway section to prevent damage to the wires.
- The drive might not keep its IP20 protective level if wires other than those specified by Yaskawa are used, even if the wiring cover is used correctly. Contact Yaskawa or your nearest sales representative for more information.
- If the recommended gauge for the electrical wires are used, the wiring cover of the main circuit power input terminal and the drive output terminal do not need to be attached. Attach the wiring cover when using the applicable gauge for electrical wires.

6. Attach the wiring cover and terminal block cover to their initial positions and tighten the screws on the terminal block cover.



**Figure 2.101 Reattach the Wiring Cover**

7. Put the terminal cover back in its initial position.

## 2.14 Control Circuit Wiring

This section gives information about wiring the control circuit.

### ◆ Control Circuit Connection Diagram

Wire the drive control circuit as shown in Figure 2.102.

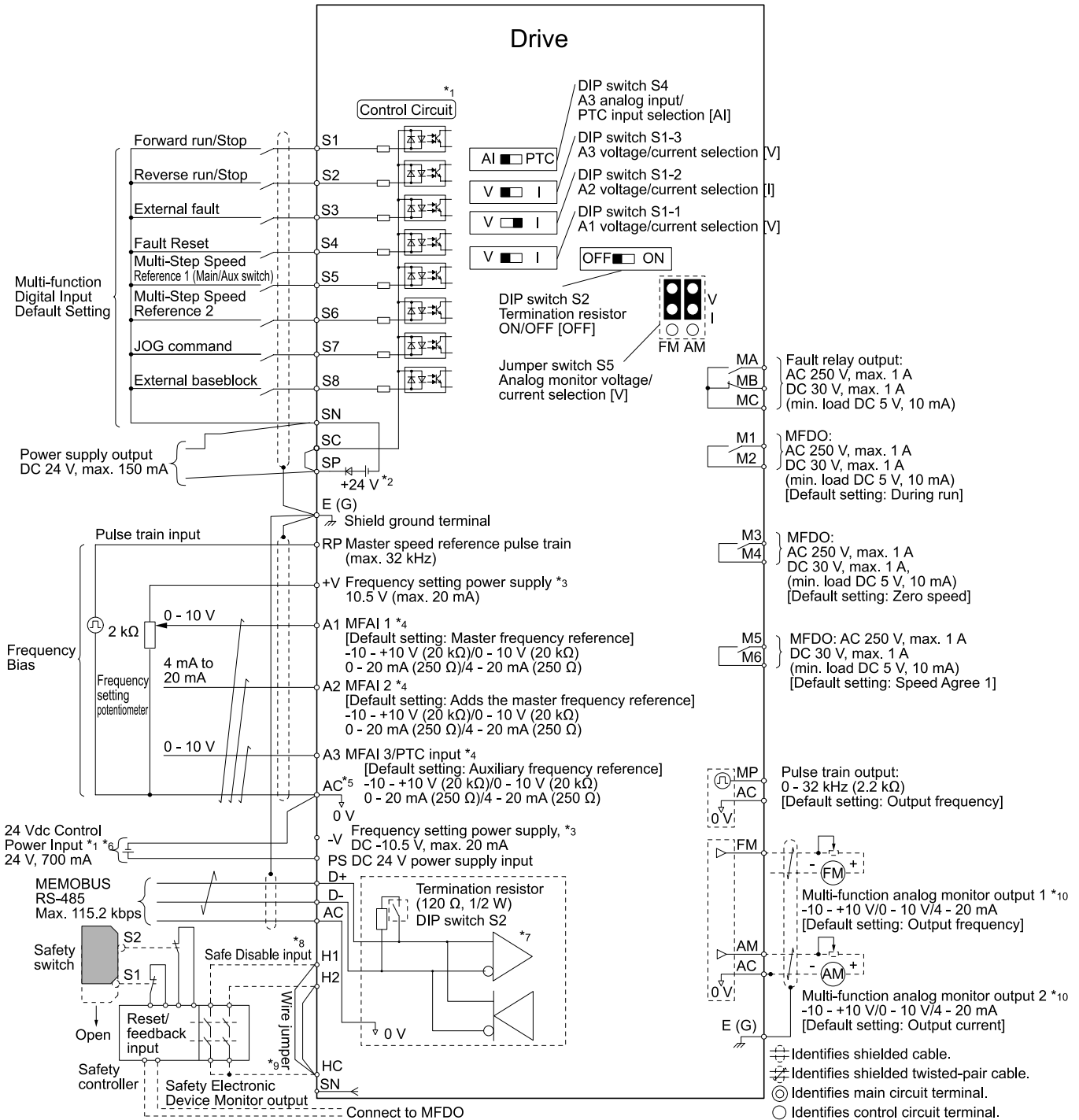


Figure 2.102 Control Circuit Connection Diagram

\*1 To operate the control circuit while the main circuit power supply is OFF, connect a 24 V power supply unit (option).

\*2 Install a wire jumper between terminals SC-SP-SN to select the type of the power supply for MFDI (sinking/sourcing mode or internal/external power supply).

**NOTICE:** Do not close the circuit between terminals SP and SN. Failure to obey will cause damage to the drive.

- Sinking Mode: Install a jumper between terminals SC and SP.



**NOTICE:** Do not close the circuit between terminals SC and SN. Failure to obey will cause damage to the drive.

- Sourcing Mode: Install a jumper between terminals SC and SN.

**NOTICE:** Do not close the circuit between terminals SC and SP. Failure to obey will cause damage to the drive.

- External power supply: Remove the wire jumper between terminals SC-SN and terminals SC-SP.

\*3 The output current capacity of the +V and -V terminals on the control circuit is 20 mA.

**NOTICE:** Do not install a jumper between terminals +V, -V, and AC. Failure to obey can cause damage to the drive.

\*4 Set DIP switches S1-1 to S1-3 to select between a voltage or current input signal to terminals A1 to A3. The default setting for S1-1 and S1-3 is voltage input (“V” side). The default setting for S1-2 is current input (“I” side).

\*5 Do not ground the control circuit terminals AC or connect them to the drive.

**WARNING!** Do not ground the control circuit terminals AC or connect them to the drive. Failure to comply may cause malfunction or failure.

\*6 Make sure that you connect terminals PS and AC correctly. Failure to obey will cause damage to the drive.

\*7 Set DIP switch S2 to the ON position to enable the termination resistor in the last drive in a MEMOBUS/Modbus communications.

\*8 To use the internal power supply with the Safe Disable input, use sourcing mode.

\*9 Disconnect the wire jumper between H1 and HC, and H2 and HC to use the Safe Disable input.

\*10 Use multi-function analog monitor outputs with analog frequency meters, ammeters, voltmeters, and wattmeters. Do not use monitor outputs with feedback-type signal devices.

## ◆ Control Circuit Terminal Block Functions

*Hx-xx parameters* set functions for the multi-function input and output terminals.

**WARNING!** Sudden Movement Hazard. Correctly wire the control circuits and make sure that control circuits operate correctly after connecting the wires. Drives with untested control circuits can cause death or serious injury.

**WARNING!** Sudden Movement Hazard. Make sure that the drive I/O signals and external sequence are correct before doing a test run. The I/O terminal function can automatically change from the factory setting when the setting for A1-06 [Application Preset] changes. Failure to obey can cause death or serious injury.

**NOTICE:** Turn the drive ON (Run) and OFF (Stop) a maximum of one time each 30 minutes with the MC on the power source side to extend the service life of the relay contacts and electrolytic capacitors in the drive. Run and Stop the motor as much as possible with the drive. The drive can fail if users frequently turn the drive ON and OFF with the MC on the power source side to Run and Stop the drive. Incorrect operation can decrease the service life of the relay contacts and electrolytic capacitors.

## ■ Input Terminals

Refer to [Table 2.20](#) for a list of input terminals and functions.

Table 2.20 Multi-function Input Terminals

Mode	Terminals	Name (Default)	Function (Signal Level)
Digital Inputs	S1	MFDI selection 1 (ON: Forward run OFF: Stop)	<ul style="list-style-type: none"> <li>• Photocoupler</li> <li>• 24 V, 6 mA</li> </ul> <p><b>Note:</b> Install the wire jumpers between terminals SC-SP and SC-SN to set the MFDI power supply.</p> <ul style="list-style-type: none"> <li>• SINK Mode: Install a jumper between terminals SC and SP.</li> </ul> <p><b>NOTICE: Do not close the circuit between terminals SC and SN. Failure to obey will cause damage to the drive.</b></p> <ul style="list-style-type: none"> <li>• SOURCE Mode: Install a jumper between terminals SC and SN.</li> </ul> <p><b>NOTICE: Do not close the circuit between terminals SC and SP. Failure to obey will cause damage to the drive.</b></p> <ul style="list-style-type: none"> <li>• External power supply: No jumper necessary between terminals SC-SN and terminals SC-SP.</li> </ul>
	S2	MFDI selection 2 (ON: Reverse run OFF: Stop)	
	S3	MFDI selection 3 (External fault (N.O.))	
	S4	MFDI selection 4 (Fault reset)	
	S5	MFDI selection 5 (Multi-step speed reference 1)	
	S6	MFDI selection 6 (Multi-step speed reference 2)	
	S7	MFDI selection 7 (Jog command)	
	S8	MFDI selection 8 (Baseblock command (N.O.))	
	SN	MFDI power supply 0 V	
	SC	MFDI selection common	<p><b>NOTICE: Do not close the circuit between terminals SP and SN. Failure to obey will cause damage to the drive.</b></p>
SP	MFDI power supply +24 Vdc		
Safe Disable Input	H1	Safe Disable input 1	<p>Remove the jumper between terminals H1-HC and H2-HC to use the Safe Disable input.</p> <ul style="list-style-type: none"> <li>• 24 V, 6 mA</li> <li>• ON: Normal operation</li> <li>• OFF: Coasting motor</li> <li>• Internal impedance 4.7 kΩ</li> <li>• Minimum OFF time of 2 ms.</li> </ul>
	H2	Safe Disable input 2	
	HC	Safe Disable function common	<p>Safe Disable function common</p> <p><b>NOTICE: Do not close the circuit between terminals HC and SN. Failure to obey will cause damage to the drive.</b></p>

Mode	Terminals	Name (Default)	Function (Signal Level)
Master Frequency Reference	RP	Master frequency reference pulse train input (Master frequency reference)	<ul style="list-style-type: none"> <li>Response frequency: 0 Hz to 32 kHz</li> <li>H level duty: 30% to 70%</li> <li>H level voltage: 3.5 V to 13.2 V</li> <li>L level voltage: 0.0 V to 0.8 V</li> <li>Input impedance: 3 k<math>\Omega</math></li> </ul>
	+V	Power supply for frequency setting	10.5 V (allowable current 20 mA maximum)
	-V	Power supply for frequency setting	-10.5 V (allowable current 20 mA maximum)
	A1	MFAI1 (Master frequency reference)	Voltage input or current input Select terminal A1 with DIP switch S1-1 and H3-01 [Terminal A1 Signal Level Select].
	A2	MFAI2 (Combined to terminal A1)	Select terminal A2 with DIP switch S1-2 and H3-09 [Terminal A2 Signal Level Select] <ul style="list-style-type: none"> <li>-10 V to +10 V/-100% to +100%</li> <li>0 V to 10 V/100% (input impedance: 20 k<math>\Omega</math>)</li> <li>4 mA to 20 mA/100%, 0 mA to 20 mA/100% (input impedance: 250 <math>\Omega</math>)</li> </ul>
	A3	MFAI3/PTC input (Auxiliary frequency reference)	<ul style="list-style-type: none"> <li>Voltage input or current input Select using DIP switch S1-3 and H3-05 [Terminal A3 Signal Level Select].</li> <li>-10 V to +10 V/-100% to +100%</li> <li>0 V to 10 V/100% (input impedance: 20 k<math>\Omega</math>)</li> <li>4 mA to 20 mA/100%, 0 mA to 20 mA/100% (input impedance: 250 <math>\Omega</math>)</li> <li>PTC input (Motor Overheat Protection) Set DIP switch S4 to "PTC" and set DIP switch S1-3 to "V" to set terminal A3 for PTC input.</li> </ul>
	AC	Frequency reference common	0 V
E (G)	Connecting shielded cable	-	

## ■ Output Terminals

Refer to [Table 2.21](#) and [Table 2.22](#) for a list of output terminals and functions.

**Table 2.21 Control Circuit Output Terminals**

Type	Terminal	Name (Default)	Function (Signal Level)
Fault Relay Output	MA	N.O. output (Fault)	<ul style="list-style-type: none"> <li>Relay output</li> <li>30 Vdc, 10 mA to 1 A</li> <li>250 Vac, 10 mA to 1 A</li> <li>Minimum load: 5 V, 10 mA (Reference value)</li> </ul>
	MB	N.C. output (Fault)	
	MC	Digital output common	
MFDO	M1	MFDO	<ul style="list-style-type: none"> <li>Relay output</li> <li>30 Vdc, 10 mA to 1 A</li> <li>250 Vac, 10 mA to 1 A</li> <li>Minimum load: 5 V, 10 mA (Reference value)</li> </ul> <p><b>Note:</b> Do not set functions that frequently switch ON/OFF to MFDO (M1 to M6) because this will decrease the performance life of the relay contacts. Yaskawa estimates switching life at 200,000 times (assumes 1 A, resistive load).</p>
	M2	(During run)	
	M3	MFDO	
	M4	(Zero speed)	
	M5	MFDO	
	M6	(Speed agree 1)	

**Table 2.22 Control Circuit Monitor Output Terminals**

Type	Terminal	Name (Default)	Function (Signal Level)
Monitor Output	MP	Pulse Train Output (Output frequency)	32 kHz (maximum)
	FM	MFAO 1 (Output frequency)	Select voltage or current output. <ul style="list-style-type: none"> <li>• 0 V to +10 V/0% to 100%</li> <li>• -10 V to +10 V/-100% to +100%</li> <li>• 4 mA to 20 mA</li> </ul> <b>Note:</b> Select with jumper switch S5 and H4-07 [Terminal FM Signal Level Select] or H4-08 [Terminal AM Signal Level Select].
	AM	MFAO 2 (Output current)	
	AC	Monitor common	0 V

■ **External Power Supply Input Terminals**

Refer to [Table 2.23](#) for a list of the functions of the external power supply input terminals.

**Table 2.23 External Power Supply Input Terminals**

Type	Terminal	Name (Default)	Function
External Power Supply Input Terminals	PS	External 24 V power supply input	Supplies backup power to the drive control circuit, keypad, and option board. 21.6 VDC to 26.4 VDC, 700 mA
	AC	External 24 V power supply ground	0 V

■ **Serial Communication Terminals**

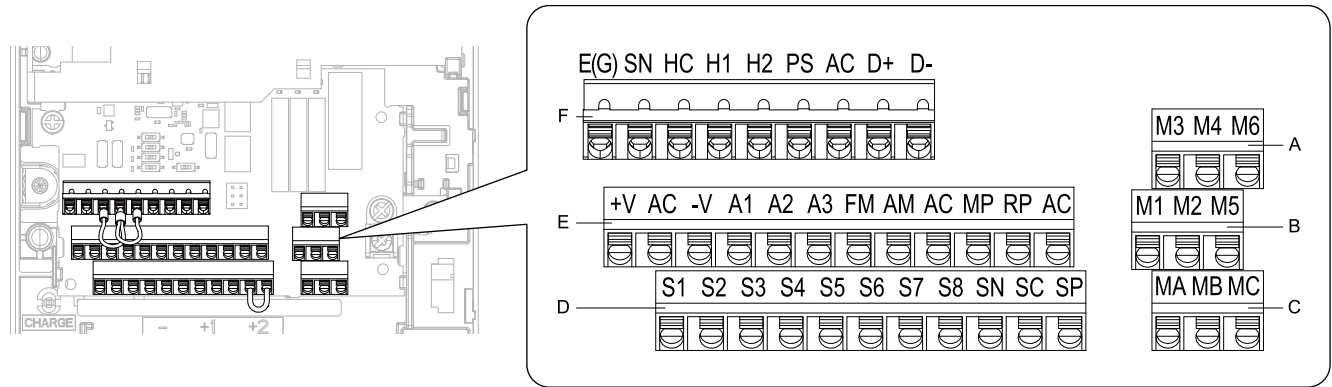
Refer to [Table 2.24](#) for a list of serial communication terminals and functions.

**Table 2.24 Serial Communication Terminals**

Type	Terminal	Terminal Name	Function (Signal Level)
MEMOBUS/Modbus Communications	D+	Communication input/output (+)	MEMOBUS/Modbus communications Use an RS-485 cable to connect the drive.  <b>Note:</b> Set DIP switch S2 to ON to enable the termination resistor in the last drive in a MEMOBUS/Modbus network.  <ul style="list-style-type: none"> <li>• RS-485</li> <li>• MEMOBUS/Modbus communication protocol</li> <li>• Maximum 115.2 kbps</li> </ul>
	D-	Communication output (-)	
	AC	Shield ground	0 V

◆ **Control Circuit Terminal Configuration**

The control circuit terminals are arranged on the drive as shown in [Figure 2.103](#).



- A - Terminal block (TB2-3)
- B - Terminal block (TB2-2)
- C - Terminal block (TB2-1)
- D - Terminal block (TB1)
- E - Terminal block (TB3)
- F - Terminal block (TB4)

Figure 2.103 Control Circuit Terminal Arrangement

### Control Circuit Wire Gauges and Tightening Torques

Use the tables in this section to select the correct wires. Use shielded wire for the control circuit terminal block. Use crimp ferrules on the wire ends to make wiring easier and more reliable.

Table 2.25 Control Circuit Wire Gauges and Tightening Torques

Terminal	Bare Wire		Crimp Ferrule	
	Recommended Gauge mm <sup>2</sup> (AWG)	Applicable Gauge mm <sup>2</sup> (AWG)	Recommended Gauge mm <sup>2</sup> (AWG)	Applicable Gauge mm <sup>2</sup> (AWG)
S1 - S8, SC, SN, SP H1, H2, HC RP, +V, -V, A1, A2, A3, AC MP, FM, AM, AC D+, D-, AC MA, MB, MC, M1-M6 PS, E(G)	0.75 (18)	<ul style="list-style-type: none"> <li>• Stranded wire 0.2 - 1.0 (24 - 18)</li> <li>• Solid wire 0.2 - 1.5 (24 - 16)</li> </ul>	0.5 (20)	0.25 - 0.5 (24 - 20)

#### Crimp Ferrules

Attach an insulated sleeve when you use crimp ferrules. Refer to Table 2.26 for the recommended external dimensions of the crimp ferrule and the model number.

Use the CRIMPFOX 6, a crimping tool made by PHOENIX CONTACT.

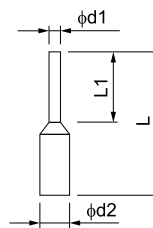


Figure 2.104 External Dimensions of Crimp Ferrules

Table 2.26 Crimp Ferrule Models and Sizes

Wire Gauge mm <sup>2</sup> (AWG)	Model	L (mm)	L1 (mm)	φd1 (mm)	φd2 (mm)
0.25 (24)	AI 0.25-8YE	12.5	8	0.8	2.0
0.34 (22)	AI 0.34-8TQ	12.5	8	0.8	2.0
0.5 (20)	AI 0.5-8WH, AI 0.5-8OG	14	8	1.1	2.5

## ◆ Wiring the Control Circuit Terminal

**WARNING!** *Electrical Shock Hazard. Do not remove covers or touch circuit boards while the drive is energized. Failure to obey can cause death or serious injury.*

**NOTICE:** *Isolate control circuit wiring from main circuit wiring (terminals R/L1, S/L2, T/L3, B1, B2, U/T1, V/T2, W/T3, -, +1, +2) and other high-power wiring. Incorrect wiring procedures could cause drive malfunction because of electrical interference.*

**NOTICE:** *Isolate contact output terminals MA, MB, MC and M1-M6 from other control circuit wiring. The drive and connected equipment will malfunction or the drive can trip because of incorrect wiring.*

**NOTICE:** *Use a class 2 power supply when connecting to the control terminals. Refer to NEC Article 725 Class 1, Class 2, and Class 3 Remote-Control, Signaling, and Power Limited Circuits for requirements concerning class 2 power supplies. Improper application of peripheral devices could result in drive performance degradation due to improper power supply.*

**NOTICE:** *Insulate wire shields with tape or shrink tubing to prevent contact with other signal lines or equipment. Incorrect wiring procedures could cause the drive or connected equipment to malfunction because of short circuits.*

**NOTICE:** *Connect the shield of shielded cable to the applicable ground terminal. Incorrect equipment grounding could cause the drive or connected equipment to malfunction or to trip again and again.*

Correctly ground the drive terminals and complete main circuit wiring before you wire the control circuit.

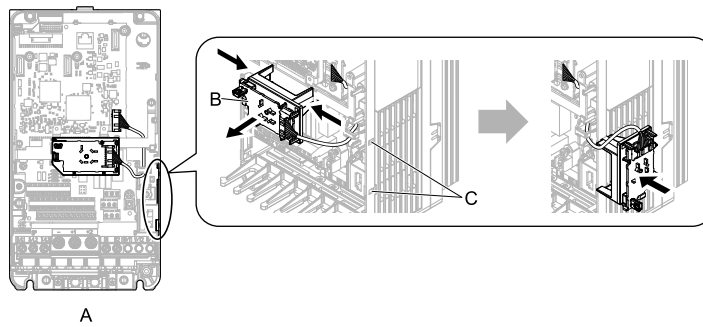
Remove the keypad and front cover.

1. Push in on the tabs on the both sides of the LED status ring board to release the board from the bracket. Pull the board forward to remove it.

**NOTICE:** *Make sure that the LED status ring board is safe after you remove it from the bracket. Failure to obey will cause damage to the LED status ring board.*

**Note:**

You can temporarily store the LED status ring board with the temporary placement holes on the drive. The location of the temporary placement holes changes by drive model.

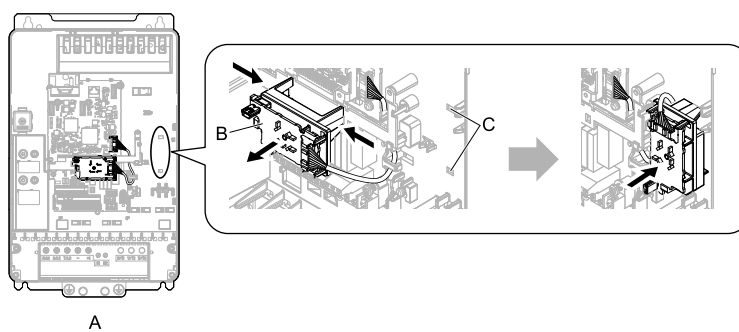


A - Drive front

B - LED status ring board

C - Temporary placement holes

Figure 2.105 Remove the LED Status Ring Board

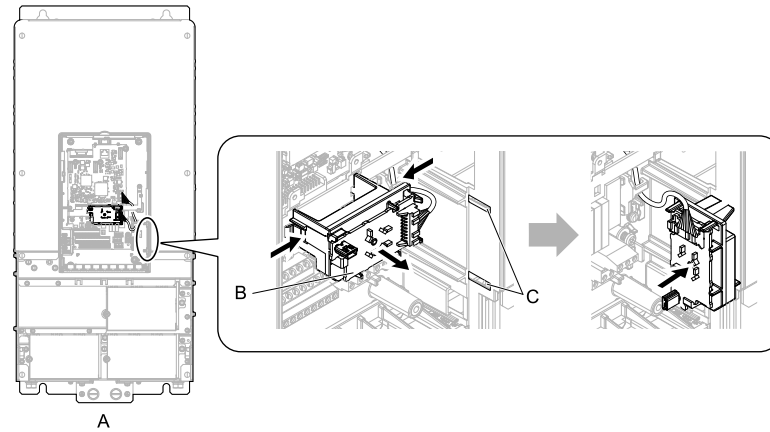


A - Drive front

B - LED status ring board

C - Temporary placement holes

Figure 2.106 Remove the LED Status Ring Board



**A - Drive front**

**B - LED status ring board**

**C - Temporary placement holes**

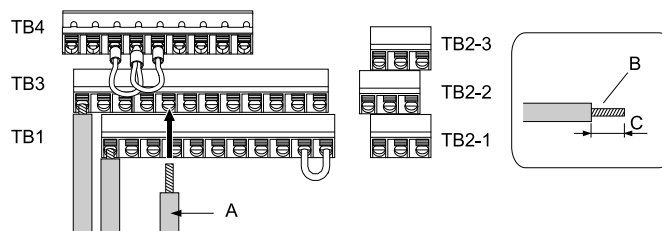
**Figure 2.107 Remove the LED Status Ring Board**

2. Refer to the following figure and wire the control circuit.

**WARNING! Fire Hazard.** Tighten all terminal screws to the correct tightening torque. Connections that are too loose or too tight can cause incorrect operation and damage to the drive. Incorrect connections can also cause death or serious injury from fire.

**NOTICE:** Use shielded, twisted-pair wires and ground the shield to the ground terminal of the drive. Failure to obey can cause electrical interference and unsatisfactory system performance.

**NOTICE:** Do not use control circuit wiring that is longer than 50 m (164 ft.) to supply the frequency reference with an analog signal from a remote source. Failure to obey could cause unsatisfactory system performance.



**A - Wire with a crimp ferrule attached, or unsoldered wire with the core wires lightly twisted**

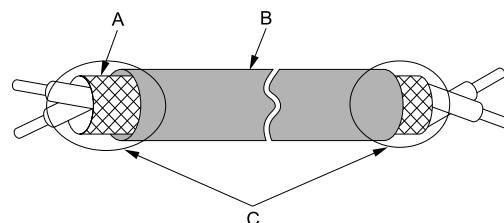
**B - Pull back the shielding and lightly twist the end with your fingers to keep the ends from fraying.**

**C - Remove approximately 5.5 mm (0.21 in.) of the covering at the end of the wire if you do not use crimp ferrules.**

**Figure 2.108 Wiring Procedure for the Control Circuit**

**Note:**

- Do not solder the core wire. Soldered wire connections can become loose over time and cause unsatisfactory drive performance.
- Refer to [Figure 2.109](#) for information to prepare terminal ends of the shielded wire.
- Prepare the wire ends of shielded twisted-pair wires as shown in [Figure 2.109](#) to use an analog reference from an external frequency setting potentiometer to set the frequency. Connect the shield to terminal E (G) of the drive.



**A - Connect the cable sheath to terminal E (G) of the drive.**

**B - Sheath**

**C - Insulate with electrical tape or shrink tubing.**

**Figure 2.109 Preparing Ends of Shielded Cable**

- Put the cable through the clearance in the wiring cover.

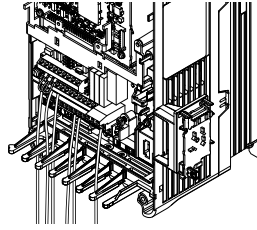


Figure 2.110 Control Circuit Wiring

- Install the LED status ring board, front cover, and the keypad to their initial positions.

### ◆ Switches and Jumpers on the Terminal Board

The terminal board has switches to adapt the drive I/Os to the external control signals as shown in Figure 2.111. Set the switches to select the functions for each terminal.

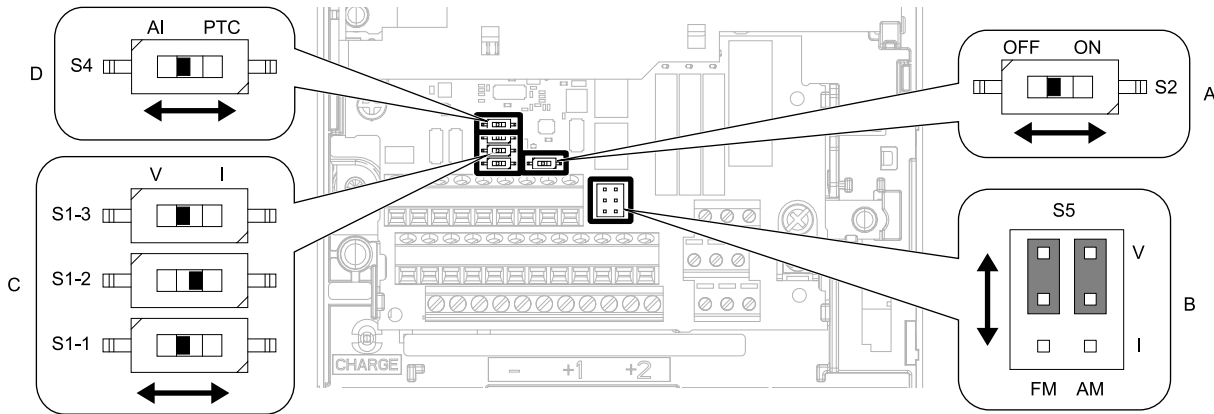


Figure 2.111 Locations of Switches

Table 2.27 I/O Terminals and Switches Functions

Position	Switch	Terminal	Function	Default Setting
A	DIP switch S2	-	Enables and disables the MEMOBUS/Modbus communications termination resistor.	OFF
B	Jumper switch S5	FM, AM	Sets terminals FM and AM to voltage or current output.	FM: V (voltage output) AM: V (voltage output)
C	DIP switch S1-1	A1	Selects the input signal type (voltage/current).	V (voltage input)
	DIP switch S1-2	A2	Selects the input signal type (voltage/current).	I (current input)
	DIP switch S1-3	A3	Selects the input signal type (voltage/current).	V (voltage input)
D	Dip switch S4	A3	Selects MFAI or PTC input.	AI (analog input)



## 2.15 Control I/O Connections

This section gives information about the settings for the listed control circuit I/O signals.

- MFDI (terminals S1 to S8)
- MFDO (terminals M1 to M6)
- Pulse train output (terminal MP)
- MFAI (terminals A1 to A3)
- PTC input (terminal A3)
- MFAO (terminals FM, AM)
- MEMOBUS/Modbus communications (terminals D+, D-, AC)

### ◆ Pulse Train Output

You can use pulse train monitor output terminal MP for sourcing mode or for sinking mode.

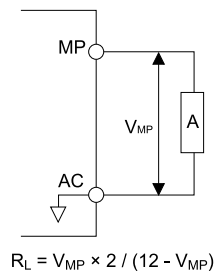
**NOTICE:** Connect peripheral devices correctly. Failure to obey can cause incorrect drive operation and damage to the drive or connected circuits.

- Use for sourcing mode  
The load impedance changes the voltage level of the pulse train output signal.

Load Impedance $R_L(k\Omega)$	Output Voltage $V_{MP}(V)$
1.5 k $\Omega$ or more	5 V or more
4.0 k $\Omega$ or more	8 V or more
10 k $\Omega$ or more	10 V or more

**Note:**

Use the formula in Figure 2.112 to calculate the necessary load resistance (k $\Omega$ ) to increase output voltage (V)<sub>MP</sub>.

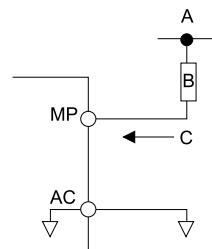


A - Load impedance

Figure 2.112 Wiring to Use Pulse Train Output in Sourcing Mode

- Use in sinking mode  
The external power supply changes the voltage level of the pulse train output signal. Keep the voltage from an external source between 10.8 Vdc to 16.5 Vdc. Adjust the load impedance to keep the current at 16 mA or lower.

External Power Supply (V)	Load Impedance (k $\Omega$ )	Sinking Current (mA)
10.8 Vdc to 16.5 Vdc	1.0 k $\Omega$ or more	16 mA maximum



A - External power supply

B - Load impedance

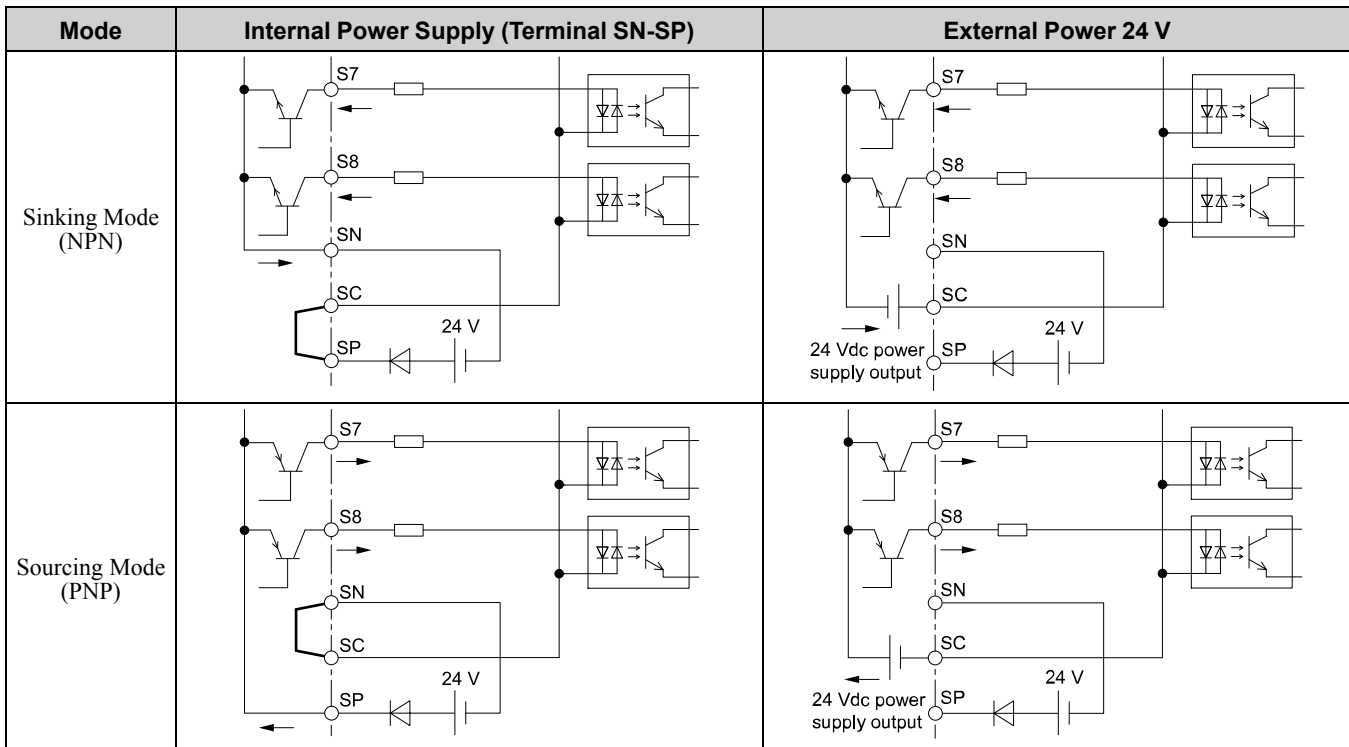
C - Sinking current

Figure 2.113 Wiring to Use Pulse Train Output in Sinking Mode

### ◆ Set Sinking Mode/Sourcing Mode

Close the circuit between terminals SC-SP and SC-SN to set the sinking mode/sourcing mode and the internal/external power supply for the MFDI terminals. The default setting for the drive is internal power supply sinking mode.

**NOTICE:** Do not close the circuit between terminals SP and SN. Failure to obey will cause damage to the drive.



### ◆ Set Input Signals for MFAI Terminals A1 to A3

Use terminals A1 to A3 to input a voltage or a current signal. Set the signal type as shown in Table 2.28.

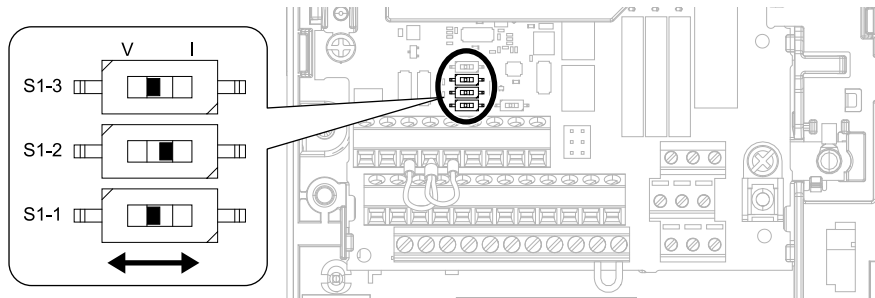


Figure 2.114 Location of DIP Switch S1

Table 2.28 MFAI Terminals A1 to A3 Signal Settings

Terminal	Input Signal	DIP Switch Settings		Parameters	
		Switch	Setting	No.	Signal Level
A1	Voltage input	S1-1	V (Default)	H3-01	0: 0 V to 10 V/0% to 100% (input impedance: 20 kΩ) 1: -10 V to +10 V/-100% to 100%
	Current input		I		2: 4 mA to 20 mA/0% to 100% 3: 0 mA to 20 mA/0% to 100% (input impedance: 250 Ω)
A2	Voltage input	S1-2	V	H3-09	0: 0 V to 10 V/0% to 100% (input impedance: 20 kΩ) 1: -10 V to +10 V/-100% to 100%
	Current input		I (Default)		2: 4 mA to 20 mA/0% to 100% 3: 0 mA to 20 mA/0% to 100% (input impedance: 250 Ω)

Terminal	Input Signal	DIP Switch Settings		Parameters	
		Switch	Setting	No.	Signal Level
A3	Voltage input	S1-3	V (Default)	H3-05	0: 0 V to 10 V/0% to 100% (input impedance: 20 kΩ) 1: -10 V to +10 V/-100% to 100%
	Current input		I		2: 4 mA to 20 mA/0% to 100% 3: 0 mA to 20 mA/0% to 100% (input impedance: 250 Ω)

**Note:**

- Set H3-02, H3-10 = 0 [Terminal A1 Function Selection, Terminal A2 Function Selection = Frequency Reference] to set A1 and A2 to frequency reference. The drive will add the analog input values together to make the frequency reference.
- Use tweezers or a jig with a tip width of approximately 0.8 mm (0.03 in.) to set DIP switches.
- Set DIP switch S4 to “AI” to use terminal A3 as an analog input (voltage/current) terminal. The default setting for DIP switch S4 is “AI”.

◆ **Set MFAI Terminal A3 to PTC Input**

Set terminal A3 as an MFAI or as the PTC input for motor overload protection. Use DIP switch S4 to set the input function.

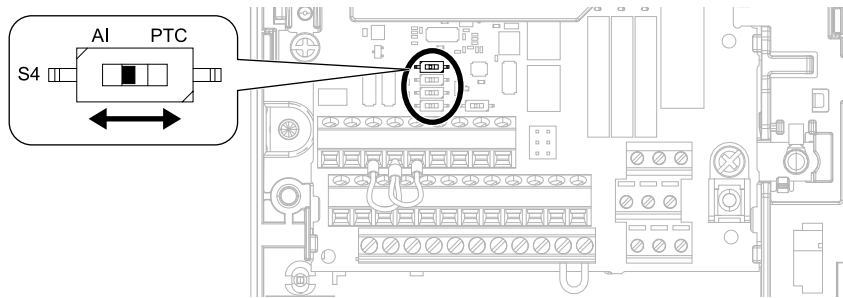


Figure 2.115 Location of DIP Switch S4

Terminal	Settings for DIP Switches	Description
A3	AI (Default)	Functions as an MFAI terminal. Set H3-06 [Terminal A3 Function Selection] to select the input function.
	PTC	Functions as the PTC input terminal. Set H3-06 = E [Motor Temperature (PTC Input)]. Set S1-3 to “V” for voltage input.

◆ **Set Output Signals for MFAO Terminals FM, AM**

Set the signal type for terminals AM and FM to voltage or current output. Use jumper switch S5 and H4-07, H4-08 [Terminal FM Signal Level Select, Terminal AM Signal Level Select] to set the signal type.

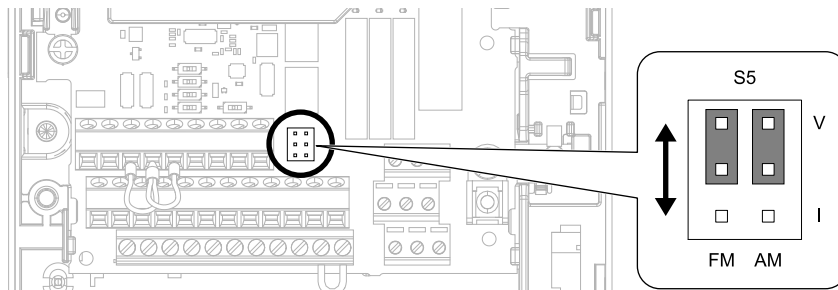
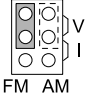
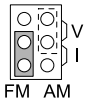
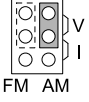
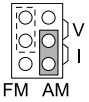


Figure 2.116 Location of Jumper Switch S5

Terminal	Types of Output Signals	Jumper Switch S5	Parameters	
			No.	Signal Level
FM	Voltage output (Default)		H4-07	0: 0 V to 10 V 1: -10 V to +10 V
	Current output			2: 4 mA to 20 mA
AM	Voltage output (Default)		H4-08	0: 0 V to 10 V 1: -10 V to +10 V
	Current output			2: 4 mA to 20 mA

◆ **Switch ON Termination Resistor for MEMOBUS/Modbus Communications**

When the drive is the last slave in a MEMOBUS/Modbus communications, set DIP switch S2 to the ON position. This drive has a built-in termination resistor for the RS-485 interface.

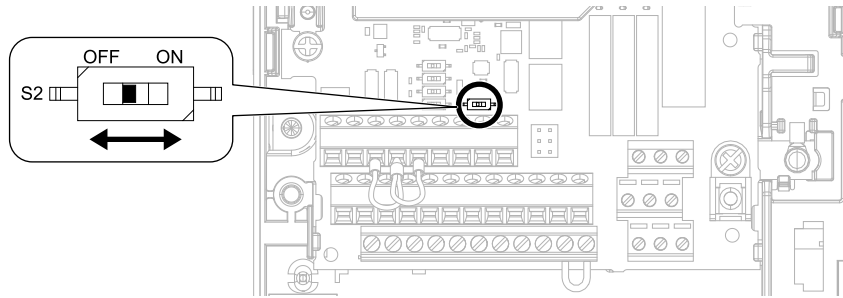


Figure 2.117 Location of DIP Switch S2

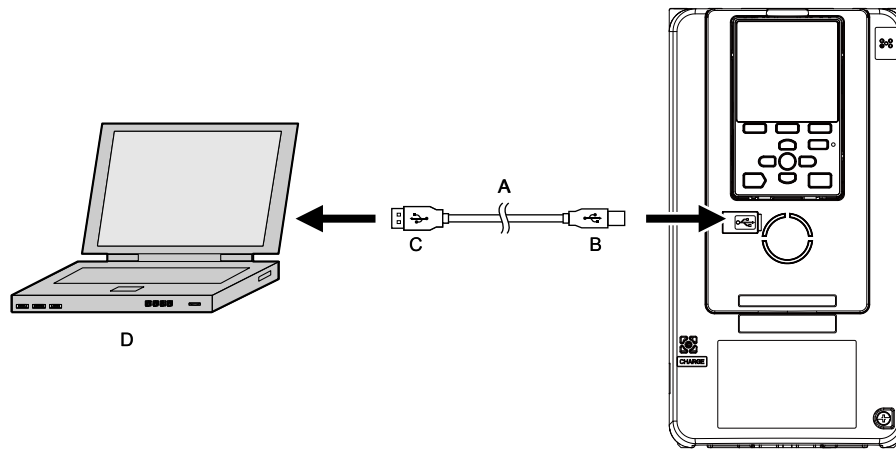
Table 2.29 MEMOBUS/Modbus Communications Termination Resistor Setting

DIP Switch S2	Description
ON	The built-in termination resistor is ON.
OFF (Default)	The built-in termination resistor is OFF.

## 2.16 Connect the Drive to a PC

The drive has a mini-B type USB port.

You can use a USB cable (USB 2.0, type: A - mini-B) to connect the drive to a type-A USB port on a PC. After you connect the drive to the PC, you can use Yaskawa DriveWizard Industrial software to monitor drive performance and manage parameter settings.



- A - USB 2.0, type A - mini-B cable**      **C - Type-A connector**  
**B - Mini-B type connector**                      **D - PC**

Figure 2.118 Connect to a PC (USB)

## 2.17 External Interlock

For applications that will have unwanted effects on the system if the drive stops, make an interlock between fault relay output (MA, MB, MC) and the MFDO *DriveReady* signal.

### ◆ Drive Ready

When the drive is operating or is prepared to accept a Run command, the MFDO terminal to which *Drive Ready* [H2-xx = 6] is set will enter the ON status.

In these conditions, Drive Ready is OFF and the drive ignores Run commands:

- The drive is de-energized
- During a fault
- There is problem with the control power supply
- There is a parameter setting error that will not let the drive run, although a Run command is entered
- An overvoltage or undervoltage fault occurs when the Run command is entered
- The drive is in Programming Mode.

### ◆ Interlock Circuit Example

Refer to [Figure 2.119](#) for an example of how two drives that run one application use the Drive Ready and Fault output signals to interlock with the controller.

Terminal	Output Signal	Parameter Settings for Output Signal
MA, MB, MC	Fault	-
M1-M2	Drive Ready	H2-01 = 6

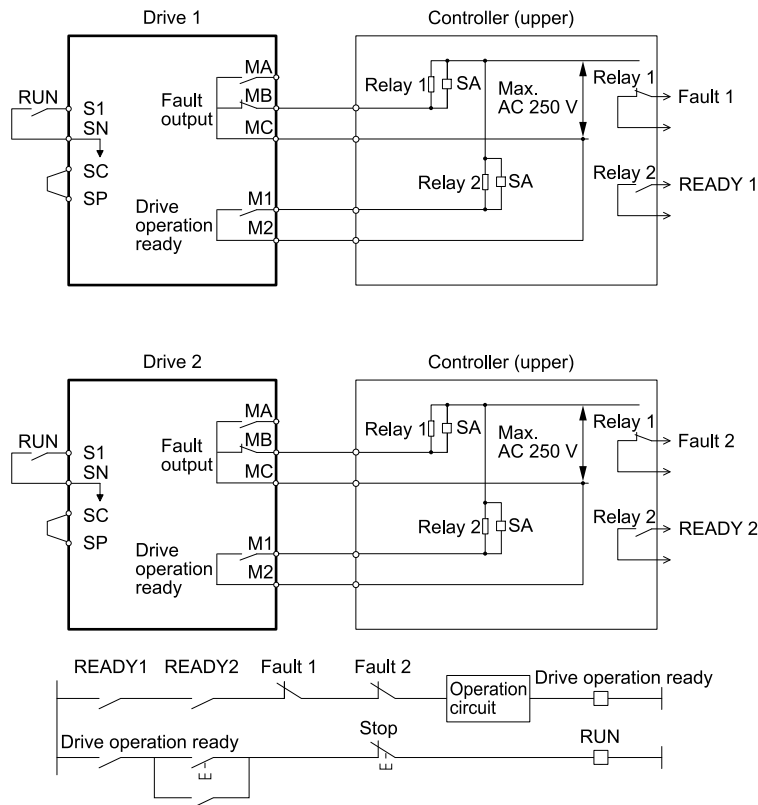


Figure 2.119 Interlock Circuit Example

## 2.18 Braking Resistor Installation

A braking resistor or braking resistor unit (dynamic braking option) helps stop the motor quickly and smoothly when there is high load inertia. If you try to decelerate a motor in less time than usual for a coast to stop, the motor will rotate faster than the synchronous speed that aligns with the set frequency. This will cause the motor to become an induction generator. The inertia energy of the motor and regenerate to the drive and charge the drive DC bus capacitor and increase the voltage. If the voltage is more than the overvoltage level, an *ov* [Overvoltage] will occur. To prevent these overvoltage faults, a dynamic braking option is necessary.

### WARNING!

Set  $L3-04 = 0$  [Stall Prevention during Decel = Disabled] when operating the drive with:

- a regenerative converter
- regenerative unit
- braking unit
- braking resistor
- braking resistor unit.

Failure to obey could prevent the drive from stopping in the specified deceleration time and cause serious injury or death.

**NOTICE:** Do not allow unqualified personnel to use the product. Before you connect a dynamic braking option to the drive, make sure that you review *Braking Unit and Braking Resistor Unit Installation Manual TOBPC72060001*. Failure to obey can cause damage to the drive and braking circuit.

### Note:

- Select the correct braking circuit size to dissipate the power that is necessary to decelerate the load in the correct time. Before you run the drive, make sure that the braking circuit can dissipate the energy for the set deceleration time.
- To install a dynamic braking option, set  $L8-01 = 0$  [3% ERF DB Resistor Protection = Disabled].

**WARNING! Fire Hazard.** The braking resistor connection terminals are B1 and B2. Do not connect braking resistors to other terminals. Incorrect wiring connections could cause the braking resistor to overheat. Failure to obey can cause death or serious injury by fire and damage to the drive and braking circuit.

**NOTICE:** Connect braking resistors to the drive as shown in the I/O wiring examples. Incorrectly wiring braking circuits can cause damage to the drive or equipment.

To connect a Yaskawa ERF series braking resistor to the drive, set  $L8-01 = 1$  [Enabled].

To use a non-ERF type braking resistor, connect a thermal overload relay between the drive and the braking resistor, and set a circuit to de-energize the drive at the trip contacts of the thermal overload relay.

### ◆ Install a Braking Resistor: ERF-Type

Connect the braking resistor to drive models 2004 to 2021 and 4002 to 4012 as shown in [Figure 2.120](#).

When you use a braking resistor, set  $L8-01 = 1$  [3% ERF DB Resistor Protection = Enabled] and set one of the MFDO parameters  $H2-01$  to  $H2-03 = D$  [MFDO Function Select = Braking Resistor Fault]. Use a sequence that uses MFDO to de-energize the drive.

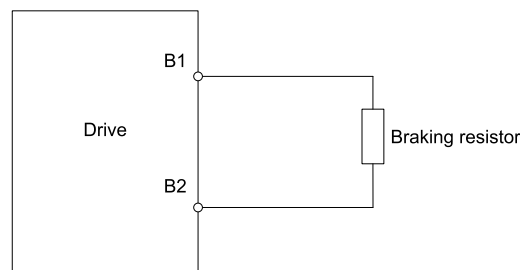


Figure 2.120 Install a Braking Resistor: ERF-Type

### ◆ Install a Braking Resistor Unit: LKEB-Type

Connect the braking resistor unit as shown in [Figure 2.121](#). To install a braking resistor unit, set  $L8-01 = 0$  [3% ERF DB Resistor Protection = Disabled].

Models 2004 to 2138 and 4002 to 4168 have a built-in braking transistor.

To prevent overheating the braking resistor unit, set a sequence to de-energize the drive at the trip contacts of the thermal overload relay.

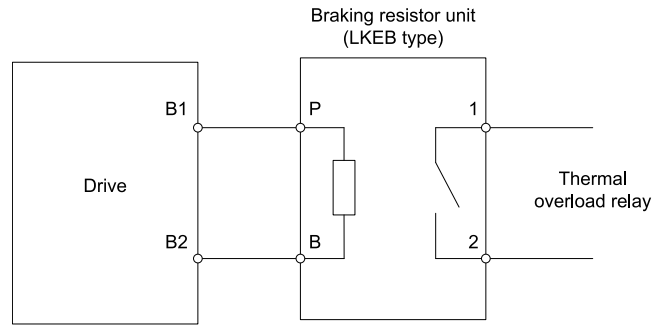


Figure 2.121 Install a Braking Resistor Unit: LKEB-Type

### ◆ Install a Braking Unit Connection: CDBR-Type

To install a CDBR type braking unit, connect terminal +3 on the drive to terminal + on the braking unit. Then connect terminal - on the drive to terminal - on the braking unit. Terminal +2 on the drive is not necessary for CDBR-type braking unit connections.

Set  $L8-55 = 0$  [*Internal DB Transistor Protection = Disable*].

**Note:**

To install a CDBR-type braking unit to the drive models 2004 to 2138 and 4002 to 4168 that have a built-in braking transistor, connect drive terminal B1 to terminal + on the braking unit.

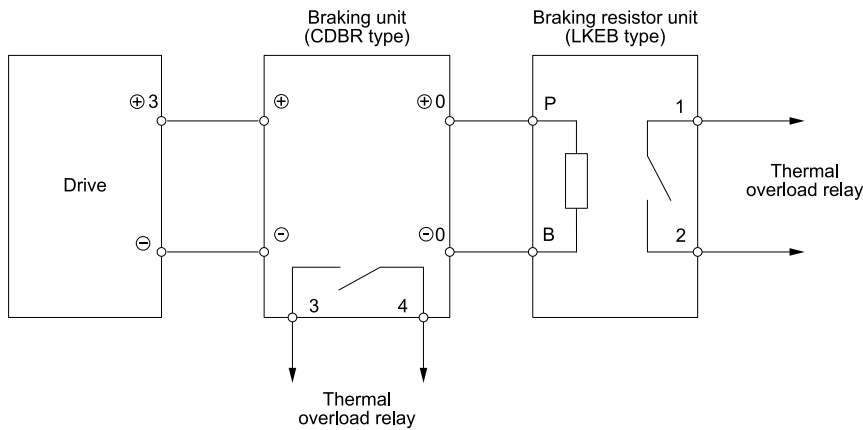


Figure 2.122 Install a Braking Unit: CDBR-Type/Braking Resistor Unit: LKEB-Type

### ◆ Connect Braking Units in Parallel

To connect two or more braking units in parallel, refer to [Figure 2.123](#) for wiring and connector selections.

Braking units have connectors to select master or slave. On the first braking unit, select the master side. On the second unit and all subsequent units, select the slave side.



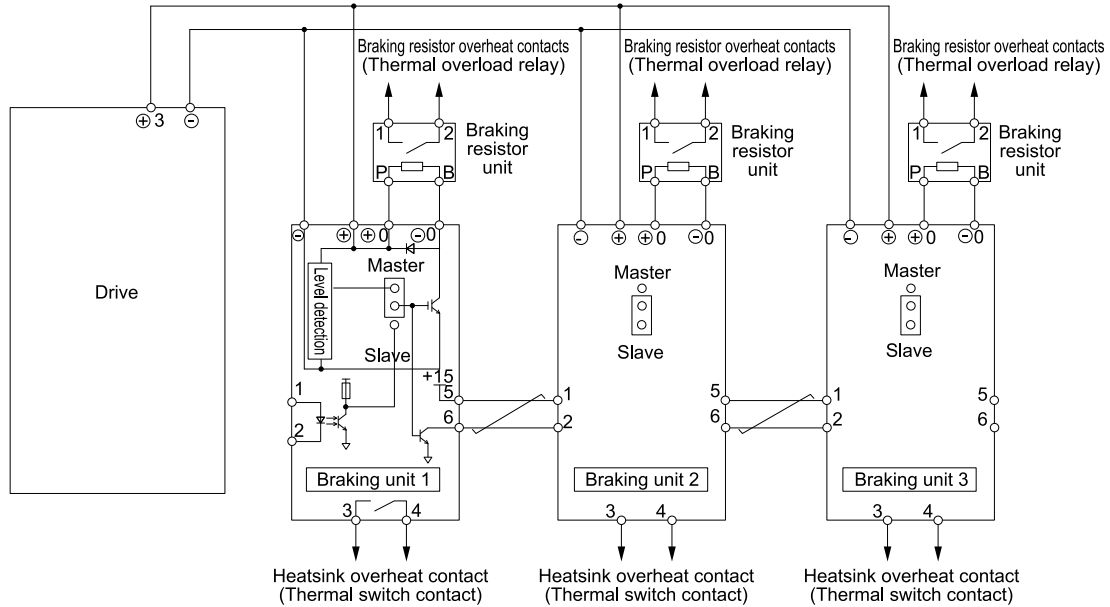


Figure 2.123 Connect Braking Units in Parallel

### ◆ Dynamic Braking Option Overload Protection

To prevent overheating the dynamic braking option, set a sequence to de-energize the drive at the trip contacts of the thermal overload relay.

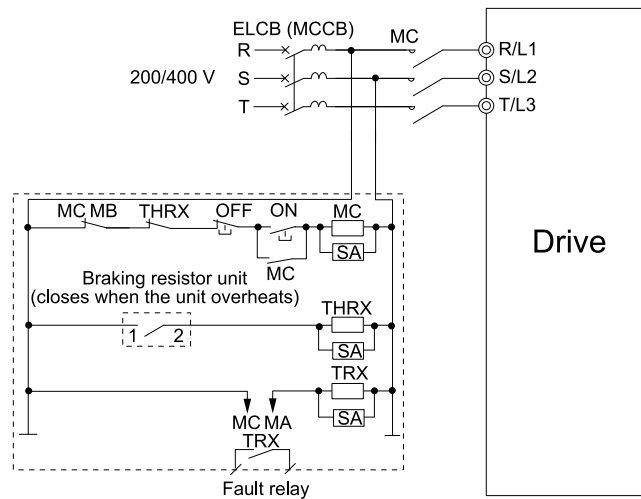


Figure 2.124 Power Supply Interrupt for Overheat Protection Example

**WARNING! Fire Hazard.** When you use a braking unit, use a thermal relay on the braking resistors and set a fault contact output for the braking resistor unit to disconnect drive main power through an input contactor. **Incorrect braking circuit protection can overheat the resistors and cause death or serious injury by fire.**

## 2.19 Drive Wiring Protection

### ◆ Install a Molded-Case Circuit Breaker (MCCB) or Residual Current Monitor/Device (RCM/RCD)

Install a molded-case circuit breaker (MCCB) or a ground fault circuit interrupter (RCM/RCD) for line protection between the power supply and main circuit power supply input terminals R/L1, S/L2, and T/L3. The MCCB/RCM/RCD give overload protection and also prevent damage to the main circuit and the devices that are wired to the main circuit.

Use the information in this section to select the correct MCCB or RCM/RCD and to safely connect the device.

- The capacity of the MCCB or RCM/RCD must be 1.5 to 2 times the rated output current of the drive. Use an MCCB or RCM/RCD as an alternative to overheat protection (150% for one minute at the rated output current) to prevent drive faults.
- When you connect more than one drive to one MCCB or RCM/RCD that is shared with other equipment, refer to [Figure 2.125](#) and use a magnetic contactor (MC) and set a sequence that de-energizes the drive when errors it outputs errors.

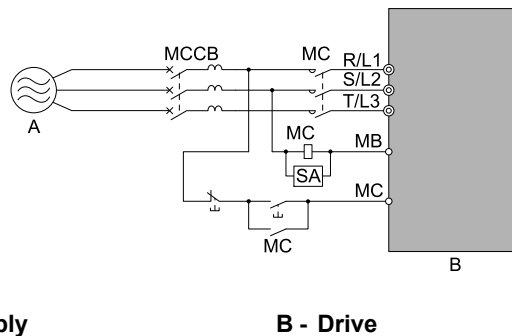


Figure 2.125 Connect an MCCB

**WARNING!** *Electrical Shock Hazard. Use an MCCB, RCM/RCD, or Magnetic Contactor (MC) to de-energize the drive before you wire the main circuit terminal. Failure to obey can cause death or serious injury.*

### ◆ Install a Residual Current Monitoring/Detection (RCM/RCD)

When the drive output does switches at high speeds, it causes high frequency leakage current. To prevent electrical shock and fires caused by ground fault protection that is not sufficient, install an RCM/RCD.

Use a high frequency RCM/RCD at the power input side of the drive and make sure that each drive has a minimum cumulative sensitivity amperage of 30 mA. The specialized breaker removes high-frequency leakage current, and only detects the leakage current from frequency bands that are dangerous to humans.

If a device does not have protection against high frequencies, high frequency leakage currents can cause the device to malfunction. If you have a malfunction on a device that is not protected, decrease the carrier frequency of the drive, switch to a better breaker, or use an RCM/RCD with a minimum cumulative sensitivity amperage of 200 mA for each drive.

These conditions can have an effect on leakage current:

- Drive capacity
- Carrier frequency
- Wiring distance and types of motor cables
- EMI/RFI filter

To prevent damage and injury to personnel and drives, use a high-frequency RCM/RCD that is rated for AC and DC power supplies.

**Note:**

Yaskawa recommends these RCM/RCDs, which are designed to operate with high frequencies.

- Mitsubishi Electric Corporation; NV series
- Schneider Electric; NS series

## 2.20 Dynamic Braking Option, Motor Protection

### ◆ Install an Electromagnetic Contactor (MC) at the Input Side of the Drive

You can use an MC as an alternative to a molded case circuit breaker (MCCB) when:

- The protective functions of the drive have been triggered
- An emergency stop occurred, and the sequence de-energizes the drive.

If an MC on the input side of the drive (primary side) stops the drive, regenerative braking will not operate, and the drive will coast to stop.

**NOTICE:** Do not connect electromagnetic switches or MCs to the output motor circuits without correct sequencing. Incorrect sequencing of output motor circuits could cause damage to the drive.

**NOTICE:** Turn the drive ON (Run) and OFF (Stop) a maximum of one time each 30 minutes with the MC on the power source side to extend the service life of the relay contacts and electrolytic capacitors in the drive. Run and Stop the motor as much as possible with the drive. The drive can fail if users frequently turn the drive ON and OFF with the MC on the power source side to Run and Stop the drive. Incorrect operation can decrease the service life of the relay contacts and electrolytic capacitors.

**NOTICE:** Use an MC to make sure that you can fully remove power to the drive when necessary. Wire the MC to open when a fault output terminal is triggered.

**Note:**

- When machinery must not restart after recovery from a momentary power loss that occurred during run, install an MC at the input side of the drive and set a sequence that does not automatically set the start signal to ON after recovery of power.
- When it is necessary to stop momentary power loss, for example to maintain a circuit that has momentary power loss, use a delayed-release MC.

### ■ Protect the Braking Resistor/Braking Resistor Unit

Use an MC on the input side (primary side) to prevent damage to the braking resistor/braking resistor unit.

**WARNING! Fire Hazard.** When you use a braking unit, use a thermal relay on the braking resistors and set a fault contact output for the braking resistor unit to disconnect drive main power through an input contactor. **Incorrect braking circuit protection can overheat the resistors and cause death or serious injury by fire.**

### ◆ Install a Thermal Overload Relay on the Drive Output

A thermal overload relay disconnects the power line to the motor during a motor overload condition to prevent damage to the motor.

Install a thermal overload relay between the drive and motor in these conditions:

- When operating more than one motor from one drive.
- When operating the motor directly from the power line with a power line bypass.

When operating one motor from one drive, it is not necessary to install a thermal overload relay. The drive has electronic motor overload protection in the drive software.

**Note:**

- When you install a thermal overload relay, set parameter  $L1-01 = 0$  [Motor Overload (oLI) Protection = Disabled].
- Set up a sequence that will trip an external fault (coast to stop) for the contacts of the thermal overload relay.

### ■ General Precautions When Using Thermal Overload Relays

When you use a motor thermal overload relay on the drive output to prevent nuisance trips and overheating of the motor at low speeds, be sure to think about these application precautions:

- Operation of a low speed motor
- Operating more than one motor from one drive
- Length of the motor cables
- Nuisance tripping because of high drive carrier frequency.

#### Operation of a Low Speed Motor

Usually, you use thermal overload relays on general-purpose motors (standard motors). When a drive drives a general-purpose motor, the motor current is approximately 5% to 10% more than with a commercial power supply. When a motor with a shaft-driven fan operates at low speeds, the cooling capacity decreases. This can cause the motor to overheat when the load current is in the motor rated value. Enable the electronic thermal protection in the drive when possible to prevent this problem.

The electronic thermal overload function uses the relation between the speed and heat characteristics in the variable speed control range to simulate the cooling ability of general-purpose motors and forced-vented motors to prevent damage to the motor.

### **Operating More than One Motor from One Drive**

To disable the overload protection function of the electronic thermal protector of the drive, set  $LI-01 = 0$  [*Motor Overload (oL1) Protection = Disabled*].

#### **Note:**

If you operate more than one motor from one drive, you cannot use the electronic thermal protection of the drive.

### **Length of the Motor Cables**

If you use long motor cables with a high carrier frequency, the increased leakage current can cause nuisance tripping of the thermal relay. To prevent this, decrease the carrier frequency or increase the tripping level of the thermal overload relay.

### **Nuisance Tripping Because of High Drive Carrier Frequency**

High carrier frequency PWM drives make current waveforms that can increase the temperature in overload relays. It may be necessary to increase the trip level setting when encountering nuisance triggering of the relay.

**WARNING! Fire Hazard.** Make sure that a secondary problem is not the cause of the overload before you increase the detection level of the thermal relay. Verify local ordinances for electrical wiring, then adjust electrothermal settings. Incorrect wiring can cause death or serious injury from fire.

## 2.21 Improve the Power Factor

### ◆ Connect an AC Reactor or a DC Reactor

AC reactors and DC reactors decrease surges in current and improve the power factor on the input side of the drive.

Connect an AC reactor or a DC reactor to the input side (primary side) in the these conditions:

- To decrease harmonic current or improve the power factor of the power supply
- When there is switching of phase advancing capacitor
- With a large capacity power supply transformer (600 kVA or more).

**Note:**

- You can use an AC reactor and DC reactor together.
- When you connect a thyristor converter (for example, a DC drive) to the same power supply system, you should use an AC reactor, regardless of the conditions of the power supply.
- The main circuit terminal block for the drive, and the terminal blocks for the AC and DC reactors come in different shapes. The drive has a European-style terminal block, and the AC and DC reactors have a circular terminal block. Use caution when you prepare the ends of the wires.

### ■ Connect an AC Reactor

**Note:**

When you connect an AC reactor to the output side (secondary side) of the driver, set  $C6-02 = 1$  [*Carrier Frequency Selection = 2.0 kHz*].

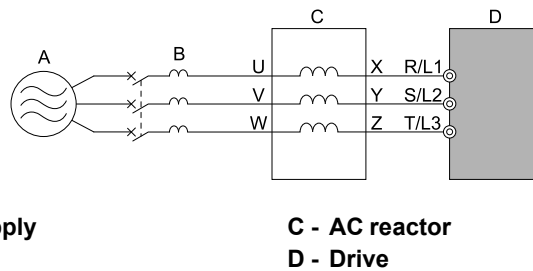


Figure 2.126 AC Reactor Connection Example

### ■ Connect a DC Reactor

When you install a DC link choke, remove the jumper between terminals +1 and +2. If you will not use a DC link choke, do not remove the jumper. Refer to [Figure 2.127](#) for an example of how to wire the DC reactor.

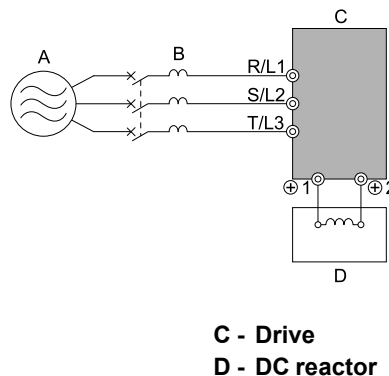


Figure 2.127 DC Reactor Connection Example

## 2.22 Prevent Switching Surge

---

### ◆ Connect a Surge Protective Device

A surge protective device decreases the surge voltage that is generated from switching an inductive load near the drive. Inductive loads include:

- Magnetic contactors
- Electromagnetic relays
- Magnetic valves
- Solenoids
- Magnetic brakes.

Always use a surge protective device or diode with inductive loads.

**Note:**

Do not connect a surge protective device to the drive output side.

## 2.23 Decrease Noise

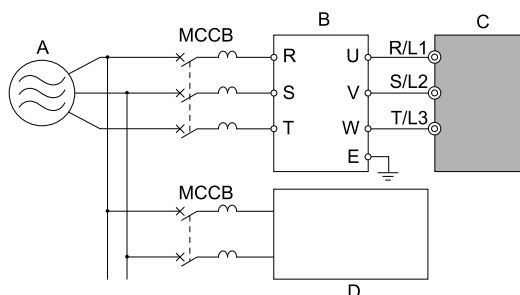
### Note:

The main circuit terminal block for the drive and the terminal block for the noise filter come in different shapes. The drive has a European-style terminal block and the noise filter has a circular terminal block. Use caution when you prepare the ends of the wires.

### ◆ Connect a Noise Filter to the Input Side (Primary Side)

High-speed switching makes noise in the drive output. This noise flows from the drive to the power supply, and can possibly have an effect on other equipment. Install a noise filter to the input side of the drive to decrease the quantity of noise that flows to the power supply. A noise filter also prevents noise from entering the drive from the power supply.

- Use a noise filter specially designed for drives.
- Install the noise filter as close as possible to the drive.



A - Power supply

B - Input side (primary side) noise filter

C - Drive

D - Other controller

### Note:

The input side (primary side) noise filter model is LNFD-xx.

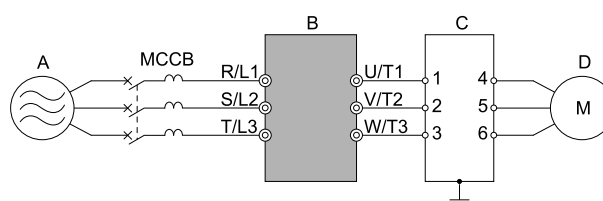
Figure 2.128 Example of Connecting the Noise Filter on the Input Side (Primary Side)

### ◆ Connect a Noise Filter to the Output Side (Secondary Side)

A noise filter on the output side of the drive decreases inductive noise and radio frequency interference.

Figure 2.129 shows an example of output-side noise filter wiring.

**NOTICE:** Do not connect phase-advancing capacitors or LC/RC noise filters to the output circuits. Failure to obey can cause damage to the drive, phase-advancing capacitors, LC/RC noise filters, and leakage breakers (ELCB, GFCI, or RCM/RCD).



A - Power supply

B - Drive

C - Noise filter on output side (secondary side)

D - Motor

Figure 2.129 Example of Connecting the Noise Filter on the Output Side (Secondary Side)

### Note:

#### Glossary

- Radio frequency interference:

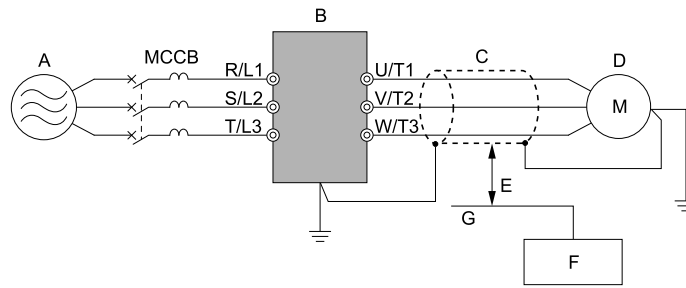
Electromagnetic waves radiated from the drive and cables make noise through the full radio bandwidth that can have an effect on nearby devices.

- Inductive noise:

The noise from electromagnetic induction can have an effect on the signal line and can cause the controller to malfunction.

### ■ Prevent Inductive Noise

In addition to installing a noise filter, you can also run all wiring through a grounded metal conduit to decrease inductive noise occurring at the output side. Put the cables a minimum of 30 cm (11.8 in.) away from the signal line to prevent induced noise. Ground the cables to metal conduits.



- |                                 |  |
|---------------------------------|--|
| <b>A - Power supply</b>         | <b>E - Minimum of 30 cm (11.8 in.) apart</b> |
| <b>B - Drive</b>                | <b>F - Controller</b>                        |
| <b>C - Shielded motor cable</b> | <b>G - Signal line</b>                       |
| <b>D - Motor</b>                |  |

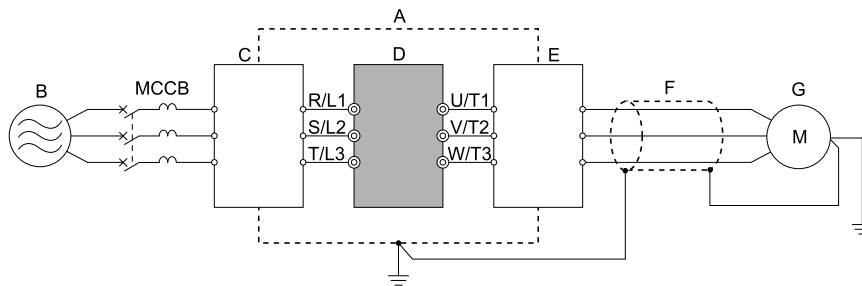
Figure 2.130 Prevent Inductive Noise

### ■ Decrease Radio Frequency Interference

The drive, input lines, and output lines generate radio frequency interference. Use noise filters on input and output sides and install the drive in a steel box to decrease radio frequency interference.

**Note:**

Keep the cable between the drive and motor as short as possible.



- |                         |                                 |
|-------------------------|---------------------------------|
| <b>A - Steel box</b>    | <b>E - Noise filter</b>         |
| <b>B - Power supply</b> | <b>F - Shielded motor cable</b> |
| <b>C - Noise filter</b> | <b>G - Motor</b>                |
| <b>D - Drive</b>        |                                 |

Figure 2.131 Decrease Radio Frequency Interference



## 2.24 Protect the Drive during Failures

### ◆ Factory-Recommended Branch Circuit Protection

Use branch circuit protection to protect against short circuits and to maintain compliance with UL61800-5-1. Yaskawa recommends connecting semiconductor protection fuses on the input side for branch circuit protection. Refer to [Table 2.30](#) to [Table 2.33](#) for the recommended fuses.

**WARNING! Electrical Shock Hazard.** Do not immediately energize the drive or operate peripheral devices after the drive blows a fuse or trips an RCM/RCD. Wait for the time specified on the warning label at a minimum and make sure that all indicators are OFF. Then check the wiring and peripheral device ratings to find the cause of the problem. Contact Yaskawa before energizing the drive or peripheral devices if the cause is not known. Failure to obey can cause death or serious injury and damage to the drive.

- 200 V class

Use the fuses specified in this document to prepare the drive for use on a circuit that supplies not more than 100,000 RMS symmetrical amperes and 240 Vac when there is a short circuit in the power supply.

- 400 V class

Use the fuses specified in this document to prepare the drive for use on a circuit that supplies not more than 100,000 RMS symmetrical amperes and 480 Vac when there is a short circuit in the power supply.

The built-in short circuit protection of the drive does not provide branch circuit protection. The user must provide branch circuit protection as specified by the National Electric Code (NEC), the Canadian Electric Code, Part I (CEC), and local codes.

**Table 2.30 Factory-Recommended Branch Circuit Protection: 200 V Class (ND)**

Drive Model	Maximum Applicable Motor Output kW (HP)	Input Current Rating A	Semiconductor Protection Fuse Rated Current Manufacturer: EATON/ Bussmann
2004	0.75 (0.75)	4.8	FWH-45B
2006	1.1 (1.5)	6.7	FWH-45B
2010	2.2 (3)	12.7	FWH-45B
2012	3 (4)	17	FWH-100B
2018	3.7 (5)	20.7	FWH-100B
2021	5.5 (7.5)	30	FWH-100B
2030	7.5 (10)	40.3	FWH-125B
2042	11 (15)	52	FWH-150B
2056	15 (20)	78.4	FWH-200B
2070	18.5 (25)	96	FWH-225A
2082	22 (30)	114	FWH-225A FWH-250A *1
2110	30 (40)	111	FWH-225A FWH-250A *1
2138	37 (50)	136	FWH-275A FWH-300A *1
2169	45 (60)	164	FWH-275A FWH-350A *1
2211	55 (75)	200	FWH-325A FWH-450A *1
2257	75 (100)	271	FWH-600A
2313	90 (125)	324	FWH-800A
2360	110 (150)	394	FWH-1000A
2415	-	-	-

\*1 Yaskawa recommends a fuse with a large rated current for applications with repeated loads.

Table 2.31 Factory-Recommended Branch Circuit Protection: 200 V Class (HD)

Drive Model	Maximum Applicable Motor Output kW (HP)	Input Current Rating A	Semiconductor Protection Fuse Rated Current Manufacturer: EATON/ Bussmann
2004	0.55 (0.5)	3.6	FWH-45B
2006	0.75 (1)	4.8	FWH-45B
2010	1.5 (2)	8.9	FWH-45B
2012	2.2 (3)	12.7	FWH-100B
2018	3 (4)	17	FWH-100B
2021	3.7 (5)	20.7	FWH-100B
2030	5.5 (7.5)	30	FWH-125B
2042	7.5 (10)	40.3	FWH-150B
2056	11 (15)	58.2	FWH-200B
2070	15 (20)	78.4	FWH-225A
2082	18.5 (25)	96	FWH-225A FWH-250A *1
2110	22 (30)	82	FWH-225A FWH-250A *1
2138	30 (40)	111	FWH-275A FWH-300A *1
2169	37 (50)	136	FWH-275A FWH-350A *1
2211	45 (60)	164	FWH-325A FWH-450A *1
2257	55 (75)	200	FWH-600A
2313	75 (100)	271	FWH-800A
2360	90 (125)	324	FWH-1000A
2415	110 (150)	394	FWH-1000A

\*1 Yaskawa recommends a fuse with a large rated current for applications with repeated loads.

Table 2.32 Factory-Recommended Branch Circuit Protection: 400 V Class (ND)

Drive Model	Maximum Applicable Motor Output kW (HP) Input Voltage < 460 V	Maximum Applicable Motor Output kW (HP) Input Voltage ≥ 460 V	Input Current Rating A	Semiconductor Protection Fuse Rated Current Manufacturer: EATON/ Bussmann
4002	0.75 (1)	0.75 (1)	2.5	FWH-50B
4004	1.5 (2)	1.5 (2)	4.7	FWH-50B
4005	2.2 (3)	2.2 (3)	6.7	FWH-50B
4007	3.0 (4)	3.0 (4)	8.9	FWH-60B
4009	4.0 (5)	3.7 (5)	11.7	FWH-60B
4012	5.5 (7.5)	5.5 (7.5)	15.8	FWH-60B
4018	7.5 (10)	7.5 (10)	21.2	FWH-80B
4023	11 (15)	11 (15)	30.6	FWH-90B
4031	15 (20)	15 (20)	41.3	FWH-150B
4038	18.5 (25)	18.5 (25)	50.5	FWH-200B
4044	22 (30)	22 (30)	59.7	FWH-200B
4060	30 (40)	30 (40)	58.3	FWH-225A
4075	37 (50)	37 (50)	71.5	FWH-250A

Drive Model	Maximum Applicable Motor Output kW (HP) Input Voltage < 460 V	Maximum Applicable Motor Output kW (HP) Input Voltage ≥ 460 V	Input Current Rating A	Semiconductor Protection Fuse Rated Current Manufacturer: EATON/ Bussmann
4089	45 (60)	45 (60)	86.5	FWH-275A
4103	55 (75)	55 (75)	105	FWH-275A
4140	75 (100)	75 (100)	142	FWH-300A
4168	90 (125)	90 (125)	170	FWH-325A FWH-400A */
4208	110 (150)	110 (150)	207	FWH-500A
4250	132 (175)	150 (200)	248	FWH-600A
4296	160 (200)	185 (250)	300	FWH-700A
4371	200 (250)	220 (300)	373	FWH-800A
4389	220 (300)	260 (350)	410	FWH-1000A
4453	250 (335)	300 (400)	465	FWH-1200A
4568	315 (400)	335 (450)	584	FWH-1200A
4675	355 (450)	370 (500)	657	FWH-1400A FWH-1600A */

\*1 Yaskawa recommends a fuse with a large rated current for applications with repeated loads.

**Table 2.33 Factory-Recommended Branch Circuit Protection: 400 V Class (HD)**

Drive Model	Maximum Applicable Motor Output kW (HP) Input Voltage < 460 V	Maximum Applicable Motor Output kW (HP) Input Voltage ≥ 460 V	Input Current Rating A	Semiconductor Protection Fuse Rated Current Manufacturer: EATON/ Bussmann
4002	0.55 (0.75)	0.55 (0.75)	1.9	FWH-50B
4004	1.1 (1.5)	0.75 (1)	3.5	FWH-50B
4005	1.5 (2)	1.5 (2)	4.7	FWH-50B
4007	2.2 (3)	2.2 (3)	6.7	FWH-60B
4009	3 (4)	3 (4)	8.9	FWH-60B
4012	4.0 (5)	3.7 (5)	11.7	FWH-60B
4018	5.5 (7.5)	5.5 (7.5)	15.8	FWH-80B
4023	7.5 (10)	7.5 (10)	21.2	FWH-90B
4031	11 (15)	11 (15)	30.6	FWH-150B
4038	15 (20)	15 (20)	41.3	FWH-200B
4044	18.5 (25)	18.5 (25)	50.5	FWH-200B
4060	22 (30)	22 (30)	43.1	FWH-225A
4075	30 (40)	30 (40)	58.3	FWH-250A
4089	37 (50)	37 (50)	71.5	FWH-275A
4103	45 (60)	45 (60)	86.5	FWH-275A
4140	55 (75)	55 (75)	105	FWH-300A
4168	75 (100)	75 (100)	142	FWH-325A FWH-400A */
4208	90 (125)	90 (125)	170	FWH-500A
4250	110 (150)	110 (150)	207	FWH-600A
4296	132 (175)	150 (200)	248	FWH-700A
4371	160 (200)	185 (250)	300	FWH-800A

## 2.24 Protect the Drive during Failures

Drive Model	Maximum Applicable Motor Output kW (HP) Input Voltage < 460 V	Maximum Applicable Motor Output kW (HP) Input Voltage ≥ 460 V	Input Current Rating A	Semiconductor Protection Fuse Rated Current Manufacturer: EATON/ Bussmann
4389	200 (250)	220 (300)	373	FWH-1000A
4453	220 (300)	260 (350)	410	FWH-1200A
4568	250 (335)	300 (400)	465	FWH-1200A
4675	315 (400)	335 (450)	584	FWH-1400A FWH-1600A <sup>*1</sup>

\*1 Yaskawa recommends a fuse with a large rated current for applications with repeated loads.

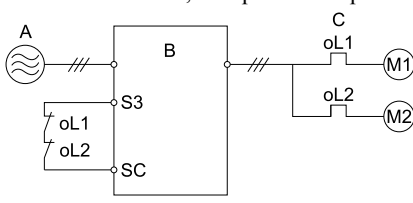
## 2.25 Wiring Checklist

Wire the drive, check these items, then do a test run.

**Table 2.34 Power Supply Voltage/Output Voltage**

Checked	No.	Item to Check
	1	The power supply voltage must be within the input voltage specification range of the drive.

**Table 2.35 Main Circuit Wiring**

Checked	No.	Item to Check
	1	Put the power supply through a molded-case circuit breaker (MCCB) before it gets to the drive input. Connect an applicable MCCB.
	2	Correctly wire the power supply to drive terminals R/L1, S/L2, and T/L3.
	3	Correctly wire the drive and motor together. The motor lines and drive output terminals U/T1, V/T2, and W/T3 must align to make the correct phase order. <b>Note:</b> If the phase order is incorrect, the drive will rotate in the opposite direction.
	4	Use 600 V heat resistant indoor PVC wire for the power supply and motor lines. <b>Note:</b> Wire gauge recommendations assume use of 600 V class 2 heat-resistant indoor PVC wire.
	5	Use the correct wire gauges for the main circuit. <b>Note:</b> • When the wiring distance between the drive and the motor is long, use this formula for the voltage drop in the wire: Motor rated voltage (V) $\times 0.02 \geq \sqrt{3} \times$ wire resistance ( $\Omega/\text{km}$ ) $\times$ wiring distance (m) $\times$ motor rated current (A) $\times 10^{-3}$ • When the cable between the drive and motor is longer than 50 m (164 ft.), use parameter C6-02 [Carrier Frequency Selection] to decrease the carrier frequency.
	6	Correctly ground the drive.
	7	Tighten main circuit and grounding terminal screws of the drive to their specified torques.
	8	When operating more than one motor from one drive, set up overload protection circuits.  <b>A - Power Supply</b> <b>B - Drive</b> <b>C - oL1 - oLn: thermal overload relay</b> <b>Note:</b> Set H1-03 = 25 [Terminal S3 Function Selection = External Fault (NC-Always-Coast)].
	9	When you use a braking resistor or a braking resistor unit, install an electromagnetic contactor (MC). Correctly install the resistor and make sure that overload protection uses the MC to shut off the power supply.
	10	Make sure that phase advancing capacitors, input noise filters, or ELCBs, GFCIs, RCM/RCDs are NOT installed on the output side of the drive.

**Table 2.36 Control Circuit Wiring**

Checked	No.	Item to Check
	1	Use twisted-pair cable for all drive control circuit wiring.
	2	Ground the shields of shielded wiring to the terminal E (G).
	3	For 3-Wire sequence, set parameters for MFDI terminals, and wire control circuits.
	4	Correctly install any option cards.
	5	Examine the drive for other wiring errors. Only use a multimeter to check wiring.
	6	Tighten the control circuit terminal screws of the drive to their specified torques.

## 2.25 Wiring Checklist

---

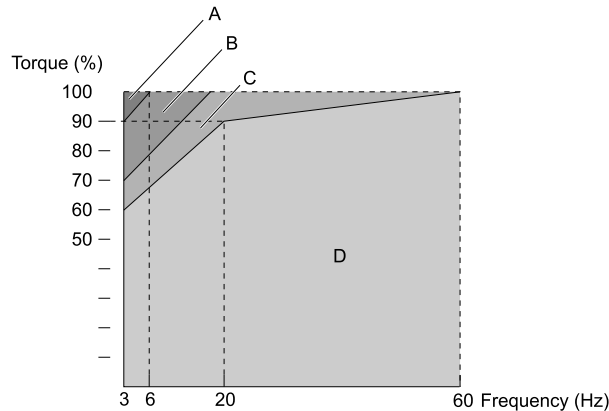
Checked	No.	Item to Check
	7	Pick up all wire clippings.
	8	Make sure that none of the wires on the terminal block touch other terminals or connections.
	9	Isolate control circuit wiring from main circuit wiring.
	10	Make sure that control circuit wiring is not longer than 50 m (164 ft.).
	11	Make sure that Safe Disable input wiring is not longer than 30 m (98 ft.).

## 2.26 Motor Application Precautions

### ◆ Precautions for Existing Standard Motors

#### ■ Low-Speed Range

When a drive operates a standard motor, it will lose more power compared to operating the motor with a commercial power supply. In the low speed range, the temperature of the motor increases quickly because the motor cannot decrease its temperature when the speed decreases. In these conditions, decrease the load torque of the motor in the low-speed range. Figure 2.132 shows the permitted load characteristics for a Yaskawa standard motor. When 100% continuous torque is necessary at low speeds, use a motor designed to operate with a drive.



A - 25% ED (or 15 min.)

B - 40% ED (or 20 min.)

C - 60% ED (or 40 min.)

D - Continuous operation

Figure 2.132 Permitted Load Characteristics for a Yaskawa Standard Motors

#### ■ Insulation Withstand Voltage

Consider motor voltage tolerance levels and motor insulation in applications with an input voltage of over 440 V or particularly long wiring distances. Use an insulated drive motor.

**NOTICE:** Use a motor that provides insulation correct for PWM drives. Failure to obey can cause a short circuit or ground fault from insulation deterioration.

#### ■ High-Speed Operation

If you operate a motor more than its rated speed, you can have problems with the motor bearing durability and dynamic balance of the machine. Contact the motor or machine manufacturer.

#### ■ Torque Characteristics

When you operate a motor with a drive, the torque characteristics are different than when you operate the motor directly from line power. Make sure that you know about the load torque characteristics for your application.

#### ■ Vibration

Vibrations could occur in the these conditions:

- Resonance with the natural frequency of machinery  
Use caution if you add a variable-speed drive to applications that operate the motor from line power at a constant speed. If resonance occurs, install shock-absorbing rubber around the base of the motor and enable the Jump frequency control.
- The motor is not balanced  
Use caution if the motor speed is more than the rated motor speed.
- Subsynchronous resonance  
Subsynchronous resonance can occur with long motor shafts and in applications such as turbines, blowers, and fans with high inertia loads.  
Use Closed Loop Vector Control when these applications have subsynchronous resonance problems.

### ■ Audible Noise

The audible noise of the motor changes when the carrier frequency setting changes. When you use a high carrier frequency, audible noise from the motor is equivalent to the motor noise generated when you operate from line power. If you operate at speeds that are more than the rated rotation speed, the unwanted motor noise increases.

---

### ◆ Precautions for PM Motors

- Contact Yaskawa or your nearest sales representative to use a non-Yaskawa PM motor.
- You cannot operate a PM motor from a commercial power supply. If you must operate from a commercial power supply, use an induction motor.
- You cannot operate more than one PM motor from one drive. Use an induction motor and a variable-speed control drive.
- In Open Loop Vector Control for PM motor (OLV/PM), the motor can operate in the reverse direction for 1/2 turn (electrical angle) at start up.
- The quantity of generated starting torque changes when the control method and motor type change. Verify the starting torque, permitted load characteristics, impact load tolerance, and speed control range before you set up the motor with the drive. Contact Yaskawa or your nearest sales representative to use a motor that does not meet these specifications.
- In OLV/PM control, braking torque is always 125% or less when operating between 20% and 100% speed. A braking resistor unit will not change the value. Braking torque is 50% or less when operating at 20% speed or less.
- In OLV/PM control, the allowable load inertia moment is approximately 50 times higher than the motor inertia moment. Use Closed Loop Vector Control for PM motors for applications with a larger inertia moment.
- When you use a holding brake in OLV/PM control, release the brake before you start the motor. Failure to set the correct timing can cause a decrease in speed. Do not use these configurations in applications with heavy loads, for example conveyors or elevators.
- To restart a coasting motor that is rotating faster than 200 Hz in V/f Control, first use the Short Circuit Braking function to stop the motor. A special braking resistor unit is necessary for Short Circuit Braking. Contact Yaskawa or your nearest sales representative for more information.  
To restart a coasting motor that is rotating slower than 200 Hz, use the Speed Search function.  
If the motor cable is long, use Short Circuit Braking to stop the motor.

#### Note:

The Short Circuit Braking function uses the drive to forcefully cause a short across the motor wires to stop the motor before it has time to coast to a stop.

- You can also use EZ Open Loop Vector Control (EZOLV) to operate synchronous reluctance motors (SynRM). Contact Yaskawa or your nearest sales representative for more information.
  - After you replace a failed PM motor encoder, make sure that the motor can rotate and do Z Pulse Offset Tuning or PM Rotational Auto-Tuning.
  - If *oC* [Overcurrent], *STPo* [Motor Step-Out Detected], or *LSo* [Low Speed Motor Step-Out] occur during restart, retry Speed Search and use the Short Circuit Braking function when starting to adjust the motor.
- 

### ◆ Precautions for Specialized Motors

#### ■ Pole Change Motors

The rated current of pole change motors is different than standard motors. Check the maximum current of the motor before you select a drive. Always stop the motor before you switch between the number of motor poles. If you change the number of poles while the motor is rotating, the overvoltage from regeneration or the overcurrent protection circuitry will make the motor coast to stop.

#### ■ Submersible Motors

The rated current of a submersible motor is more than the rated current of a standard motor. Use a sufficiently large motor cable that will not let voltage drop decrease the maximum torque level.

#### ■ Explosion-Proof Motors

You must test the motor and the drive together for explosion-proof certification. You must also test existing installations of explosion-proof motors. The drive is not designed for explosion-proof areas. Install the drive in a safe location.



---

The encoder used with pressure-resistant explosion-proof motors is intrinsically safe. When wiring between the drive and encoder, always connect through a specialized pulse coupler.

### ■ Geared Motors

The continuous speed range is different for different lubricating methods and manufacturers. For oil lubrication, continuous operation in the low-speed range can cause burnout. Contact the manufacturer for more information about applications where operating at more than the rated frequency is necessary.

### ■ Single-Phase Motors

Variable speed drives are not designed to operate with single-phase motors. The drive is for use with three-phase motors only. If you use capacitors to start the motor, it can cause a high frequency current to flow to the capacitors and can damage the capacitors. A split-phase start or a repulsion start can burn out the starter coils because the internal centrifugal switch is not activated.

### ■ Motors with Brakes

If you use a drive to operate a motor that has a brake connected to the output side, low voltage levels can cause the brake to possibly not release at start. Use a motor with a brake that has a dedicated source of power for the brake. Connect the brake power supply to the power supply side of the drive. Motors with built-in brakes make noise when operating at low speeds.

---

### ◆ Notes on the Power Transmission Mechanism

For power transmission machinery that uses oil to lubricate gearboxes, transmissions, or reduction gears, make sure that you use precaution if you operate the machinery continuously at low speed. Oil does not lubricate the system as well at low speeds. If you operate at frequencies higher than the rated frequency, it can cause problems with the power transmission mechanism. These problems include audible noise, decreased service life, and decreased durability.



## Startup Procedure and Test Run

---

3.1	Safety Precautions .....	140
3.2	Component Names and Functions .....	141
3.3	LED Status Ring.....	147
3.4	Start-up Procedures .....	149
3.5	Items to Check before Starting Up the Drive.....	153
3.6	Keypad Operation .....	155
3.7	Automatic Parameter Settings Optimized for Specific Applications (Application Presets).....	190
3.8	Auto-Tuning .....	192
3.9	Test Run .....	202
3.10	Fine Tuning during Test Runs (Adjust the Control Function).....	204
3.11	Test Run Checklist .....	215

## 3.1 Safety Precautions

### DANGER

#### Electrical Shock Hazard

**Do not examine, connect, or disconnect wiring on an energized drive. Before servicing, disconnect all power to the equipment and wait for the time specified on the warning label at a minimum. The internal capacitor stays charged after the drive is de-energized. The charge indicator LED extinguishes when the DC bus voltage decreases below 50 Vdc. When all indicators are OFF, remove the covers before measuring for dangerous voltages to make sure that the drive is safe.**

Failure to obey will cause death or serious injury.

### WARNING

#### Electrical Shock Hazard

**Do not operate equipment when covers are missing. Some figures in this section include drives without covers or safety shields to more clearly show the inside of the drive. Replace covers and shields before operation. Use drives only as specified by the instructions.**

Failure to obey can cause death or serious injury.

**Do not remove covers or touch circuit boards while the drive is energized.**

Failure to obey can cause death or serious injury.

**Prepare an isolated holding brake. The holding brake wiring must activate an external sequence to de-energize the drive or trigger an emergency switch when the drive detects a fault.**

Failure to obey could cause death or serious injury.

#### Crush Hazard

**In hoist applications, use the applicable safety precautions to prevent the load from falling.**

Failure to obey can cause death or serious injury from falling loads.

## 3.2 Component Names and Functions

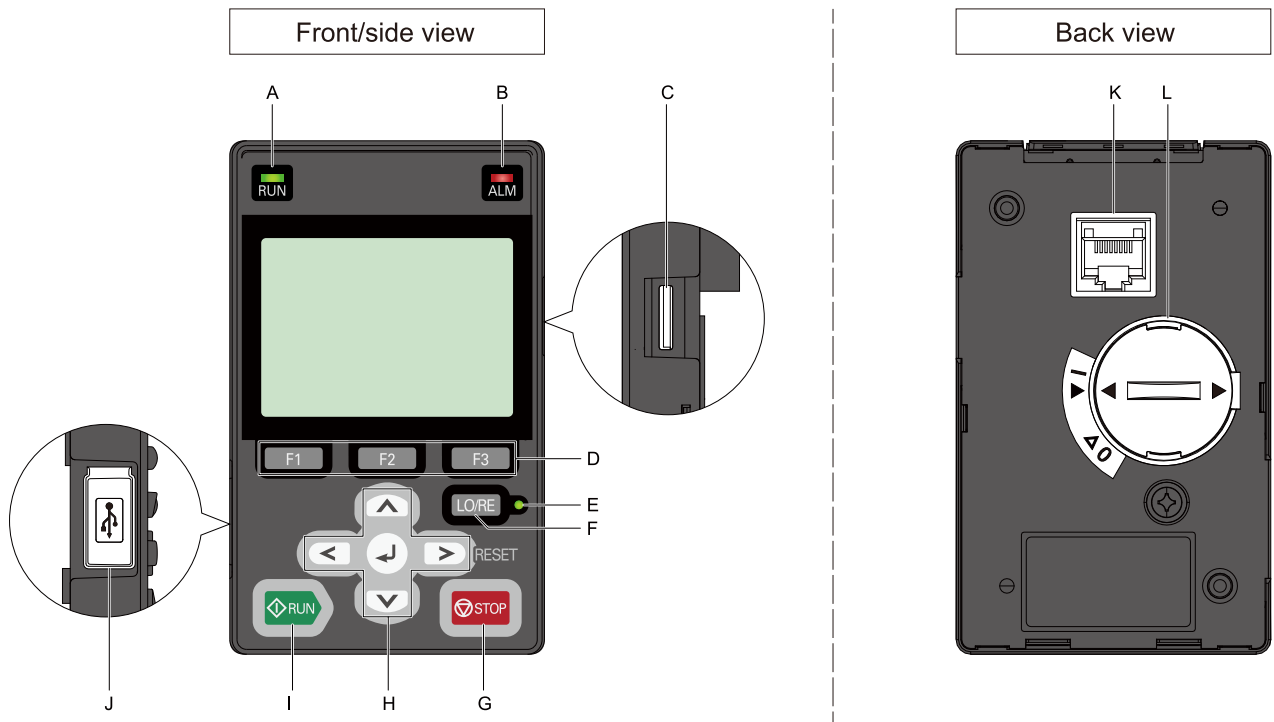


















Figure 3.1 Keypad

Table 3.1 Keypad: Names and Functions

No.	Name	Function
A	RUN LED 	Illuminates to show that the drive is operating the motor. The LED turns OFF when the drive stops. Flashes to show that: <ul style="list-style-type: none"> <li>The drive is decelerating to stop.</li> <li>The drive received a Run command but the frequency reference is 0 Hz.</li> </ul> Flashes quickly to show that: <ul style="list-style-type: none"> <li>The drive received a Run command from the Multi-Function Digital Input (MFDI) terminals and is switching to REMOTE Mode while the drive is in LOCAL Mode.</li> <li>The drive received a Run command from the MFDI terminals when the drive is not in Drive Mode.</li> <li>The drive received a Fast Stop command.</li> <li>The safety function shuts off the drive output.</li> </ul> <ul style="list-style-type: none"> <li>The user pushed  on the keypad while the drive is operating in REMOTE Mode.</li> <li>The drive is energized with an active Run command and <math>b1-17 = 0</math> [Run Command at Power Up = Disregard Existing RUN Command].</li> </ul>
B	ALM LED 	Illuminates when the drive detects a fault. Flashes when the drive detects: <ul style="list-style-type: none"> <li>Alarm</li> <li>An oPE parameter setting error</li> <li>A fault or alarm during Auto-Tuning</li> </ul> The light switches off when the drive is in normal operation. There is no fault or alarm.
C	microSD Card Insertion Slot	The insertion point for a microSD card.
D	Function Keys (F1, F2, F3) 	The menu shown on the keypad sets the functions for function keys. The name of each function is in the lower half of the display window.

### 3.2 Component Names and Functions

No.	Name	Function
E	LO/RE LED 	Illuminated: The keypad controls the Run command (LOCAL Mode). OFF: The control circuit terminal or serial transmission device controls the Run command (REMOTE Mode). <b>Note:</b> <ul style="list-style-type: none"> <li>• LOCAL: Operated using the keypad. Use the keypad to enter Run/Stop commands and the frequency reference command.</li> <li>• REMOTE: Operated from the control circuit terminal or serial transmission. Use the frequency reference source entered in <i>b1-01</i> and the Run command source selected in <i>b1-02</i>.</li> </ul>
F	LO/RE Selection Key 	Switches drive control for the Run command and frequency reference between the keypad (LOCAL) and an external source (REMOTE). <b>Note:</b> <ul style="list-style-type: none"> <li>• Stop operation to enable the LO/RE Selection Key when in Drive Mode. Set <i>o2-01 = 0</i> [<i>LO/RE Key Function Selection = Disabled</i>] to disable  when switching from REMOTE to LOCAL will have a negative effect on system performance.</li> <li>• The drive will not switch between LOCAL and REMOTE when it is receiving a Run command from an external source.</li> </ul>
G	STOP Key 	Stops drive operation. <b>Note:</b> The STOP key has highest priority. Push  to stop the motor even when a Run command (REMOTE Mode) is active at any external Run command source. Set <i>o2-02 = 0</i> [ <i>STOP Key Function Selection = Disabled</i> ] to disable the priority in  .
H	Left Arrow Key 	Moves the cursor to the left.
	Up Arrow Key/Down Arrow Key 	<ul style="list-style-type: none"> <li>• Scrolls up or down to display the next item or the previous item.</li> <li>• Selects parameter numbers, and increments or decrements setting values.</li> </ul>
	Right Arrow Key (RESET) 	<ul style="list-style-type: none"> <li>• Moves the cursor to the right.</li> <li>• Continues to the next screen.</li> <li>• Clears drive faults.</li> </ul>
	ENTER Key 	<ul style="list-style-type: none"> <li>• Enters parameter values and settings.</li> <li>• Selects menu items to move the user between keypad displays.</li> <li>• Selects each mode, parameter, and set value.</li> </ul>
I	RUN Key 	Starts the drive in LOCAL mode. Starts the motor tuning procedure in Auto-Tuning Mode. <b>Note:</b> Push  on the keypad to set the drive to LOCAL Mode before using the keypad to operate the motor.
J	USB Terminal	Insertion point for a mini USB cable. Uses a USB cable (USB standard 2.0, type A - mini-B) to connect the keypad to a PC.
K	RJ-45 Connector	Connects to the drive using an RJ-45 8-pin straight through UTP CAT5e extension cable or keypad connector.
L	Clock Battery Cover	Cover for the customer-supplied clock battery. <b>Note:</b> <ul style="list-style-type: none"> <li>• Refer to “Replace the Keypad Battery” (page 437) for details on the battery models and installation procedure.</li> <li>• Make sure to prepare the clock battery. The clock battery is not supplied as accessories.</li> </ul>

**WARNING! Sudden Movement Hazard.** The drive may start unexpectedly if switching control sources when setting *b1-07 = 1* [*LOCAL/REMOTE Run Selection = Accept Existing RUN Command*]. Clear all personnel from rotating machinery and electrical connections prior to switching control sources. Failure to comply may cause death or serious injury.

## ◆ LCD Display

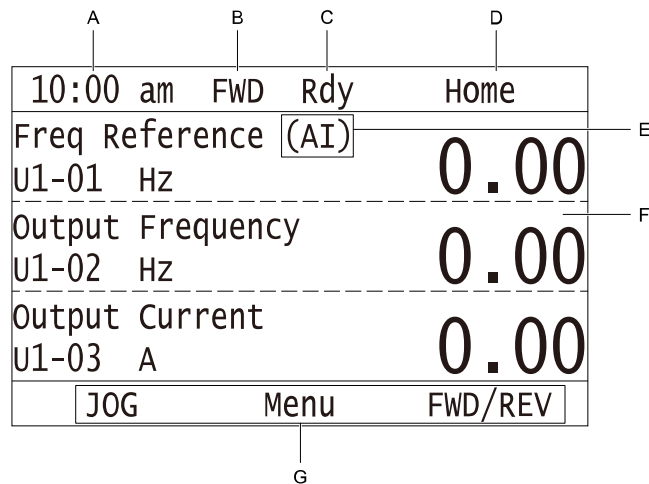






Figure 3.2 LCD Display Indications

Table 3.2 LCD Display Indications and Meanings

Symbol	Name	Description
A	Time display area	Shows the current time. Set the time on the default settings screen.
B	Forward run/ Reverse indication	Shows direction of motor rotation. <ul style="list-style-type: none"> <li>• FWD: Shown when set to Forward run.</li> <li>• REV: Shown when set to Reverse run.</li> </ul> <b>Note:</b> In DriveWorksEZ operation, FWD or REV flash.
C	Ready	The screen will show Rdy when the drive is ready for operation or when the drive is running.
D	Mode display area	Shows the name of the current mode or screen.
E	Frequency reference source indicator	Shows the current frequency reference source. <ul style="list-style-type: none"> <li>• KPD: keypad</li> <li>• AI: analog input terminal (terminals A1 to A3)</li> <li>• COM: MEMOBUS/Modbus communications</li> <li>• OPT: option card</li> <li>• RP: pulse train input terminal (terminal RP)</li> </ul>
F	Data display area	Shows parameter values, monitor values, and details of the results of operations.
G	Function keys 1 to 3 (F1 to F3)	The function names shown in this area will change when the selected screen changes. Push one of the function keys <b>F1</b> to <b>F3</b> on the keypad to do the function.

◆ Indicator LEDs and Drive Status

Indicator	Display	Drive Status
<b>RUN LED</b> 	Illuminated	The drive is operating the motor.
	Flashing	<ul style="list-style-type: none"> <li>The drive is decelerating to stop.</li> <li>The drive received a Run command but the frequency reference is 0 Hz.</li> <li>The drive received a DC Injection Braking command.</li> </ul>
	Flashing Quickly	<ul style="list-style-type: none"> <li>The drive received a Run command from the Multi-Function Digital Input (MFDI) terminals and is switching to REMOTE Mode while the drive is in LOCAL Mode.</li> <li>The drive received a Run command from the external source when the drive is not in the Drive Ready (READY) state.</li> <li>The drive received a Fast Stop command.</li> <li>The safety function shuts off the drive output.</li> <li>The user pushed  on the keypad while the drive is operating in REMOTE Mode.</li> <li>The drive is energized with an active Run command and <math>b1-17 = 0</math> [Run Command at Power Up = Disregard Existing RUN Command].</li> <li>When <math>b1-03 = 3</math> [Stopping Method Selection = Coast to Stop with Timer], the Run command is disabled then enabled during the Run wait time.</li> <li>The drive received a DC Injection Braking command.</li> </ul>
	OFF	The motor is stopped.
<b>ALM LED</b> 	Illuminated	The drive detects a fault.
	Flashing	The drive detects: <ul style="list-style-type: none"> <li>Alarm</li> <li>An oPE parameter setting error</li> <li>Auto-Tuning Errors</li> </ul> <b>Note:</b> The digital characters shown on the keypad will also flash.
	OFF	The drive does not detect fault or alarm.
<b>LO/RE LED</b> 	Illuminated	The keypad controls the Run command (LOCAL Mode).
	OFF	The control circuit terminal or serial transmission device controls the Run command (REMOTE Mode).

■ LED Flashing Statuses

Refer to Figure 3.3 for the difference between flashing and flashing quickly.

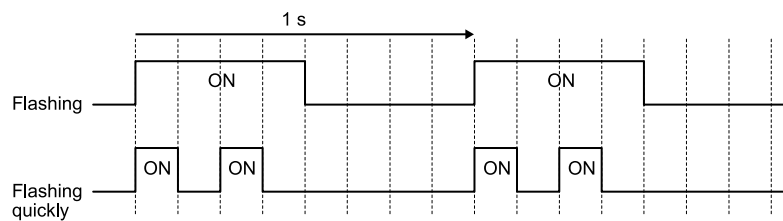


Figure 3.3 LED Flashing Statuses

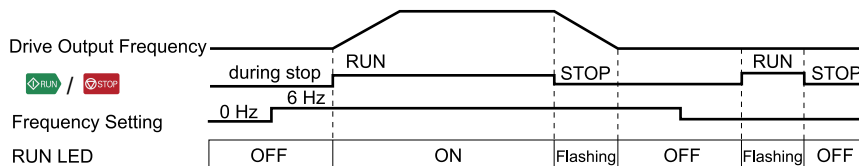


Figure 3.4 Relation between RUN LED and Drive Operation



◆ Keypad Mode and Menu Displays

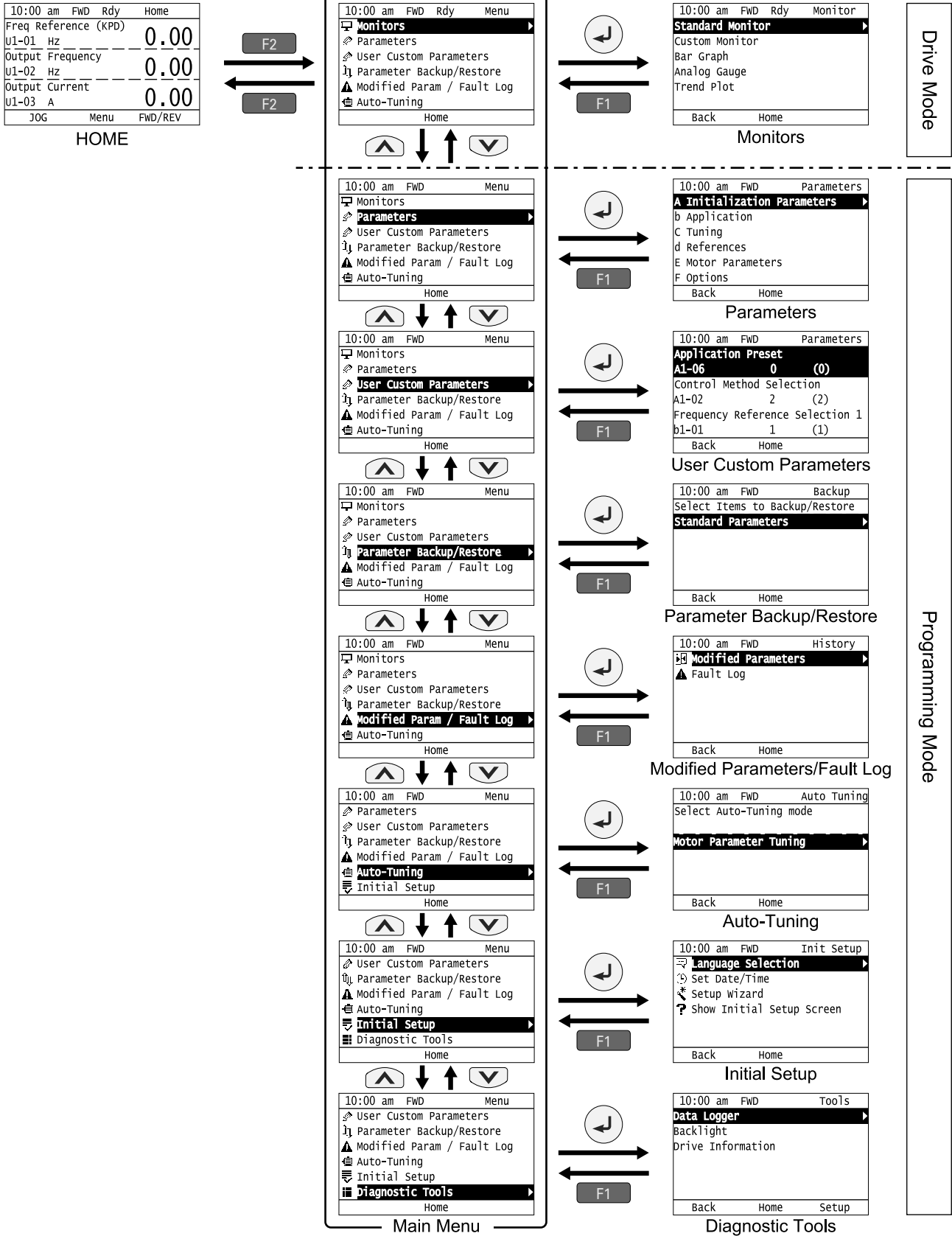




Figure 3.5 Keypad Functions and Display Levels

## 3.2 Component Names and Functions

### Note:

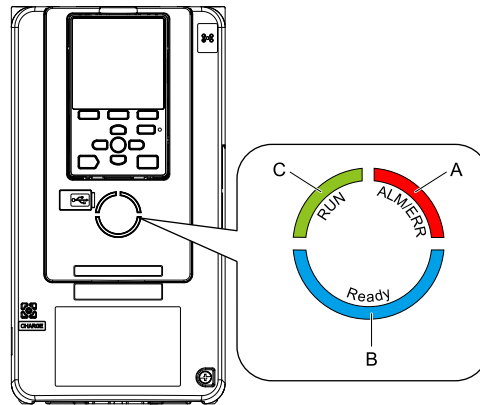
- Energize the drive with factory defaults to show the Initial Setup screen. Push **F2** (Home) to show the HOME screen.  
–Select [No] from the [Show Initial Setup Screen] setting to not display the Initial Setup screen.
- Push  from the Home screen to show drive monitors.
- Push  to set *d1-01 [Reference 1]* when the Home screen shows *U1-01 [Frequency Reference]* in LOCAL Mode.
- The keypad will show [Rdy] when the drive is in Drive Mode. The drive is prepared to accept a Run command.
- The drive will not accept a Run command in Programming Mode in the default setting. Set *b1-08 [Run Command Select in PRG Mode]* to accept or reject a Run command from an external source while in Programming Mode.  
–Set *b1-08 = 0 [Disregard RUN while Programming]* to reject the Run command from an external source while in Programming Mode (default).  
–Set *b1-08 = 1 [Accept RUN while Programming]* to accept the Run command from an external source while in Programming Mode.  
–Set *b1-08 = 2 [Allow Programming Only at Stop]* to prevent changes from Drive Mode to Programming Mode while the drive is operating.

**Table 3.3 Drive Mode Screens and Functions**

Mode	Keypad Screen	Function
Drive Mode	Monitors	Sets monitor items to display.
Programming Mode	Parameters	Changes parameter settings.
	User Custom Parameters	Shows the User Parameters.
	Parameter Backup/Restore	Saves parameters to the keypad as backup.
	Modified Parameters/Fault Log	Shows modified parameters and fault history.
	Auto-Tuning	Auto-Tunes the drive.
	Initial Setup	Changes initial settings.
	Diagnostic Tools	Sets data logs and backlight.


## 3.3 LED Status Ring

The LED Status Ring on the drive cover shows the drive operating status.



A - ALM/ERR  
B - Ready

C - RUN

LED	Status	Description	
A	ALM/ERR	<p>Illuminated</p> <p>The drive detects a fault.</p> <p>Flashing <sup>*1</sup></p> <p>The drive detects:</p> <ul style="list-style-type: none"> <li>An Alarm</li> <li>An oPE parameter setting error</li> <li>A fault or error during Auto-Tuning.</li> </ul> <p><b>Note:</b> The LED will illuminate to identify a fault if the drive detects a fault and an alarm at the same time.</p> <p>OFF</p> <p>No fault or alarm occurs on the drive.</p>	
	B	Ready	<p>Illuminated</p> <p>The drive is operating or is prepared for operation.</p> <p>Flashing <sup>*1</sup></p> <p>The drive is in <i>Sto</i> [<i>Safe Torque OFF</i>] Mode.</p> <p>Flashing Quickly <sup>*1</sup></p> <p>The voltage of the main circuit power supply dropped, and only the external 24 V power supply provides the power to the drive.</p> <p>OFF</p> <ul style="list-style-type: none"> <li>The drive detects a fault.</li> <li>There is no fault and the drive received a Run command, but the drive cannot operate. For example, in Programming Mode or when  is flashing.</li> </ul>
		C	RUN

\*1 Refer to [Figure 3.6](#) for the difference between "flashing" and "flashing quickly".

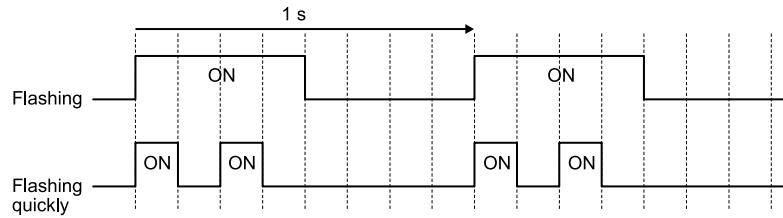


Figure 3.6 LED Flashing Statuses

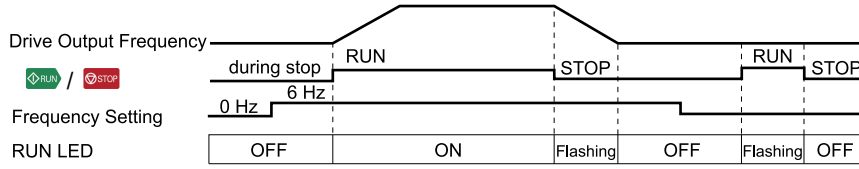


Figure 3.7 Relation between RUN LED and Drive Operation

## 3.4 Start-up Procedures

This section gives the basic steps necessary to start up the drive.

Use the flowcharts in this section to find the most applicable start-up method for your application.

This section gives information about only the most basic settings.

**Note:**

Refer to the *A1-06* section to use an Application Preset to set up the drive.

### ◆ Flowchart A: Connect and Run the Motor with Minimum Setting Changes

Flowchart A shows a basic start-up sequence to connect and run a motor with a minimum of setting changes. Settings can change when the application changes.

Use the drive default parameter settings for basic applications where high precision is not necessary.

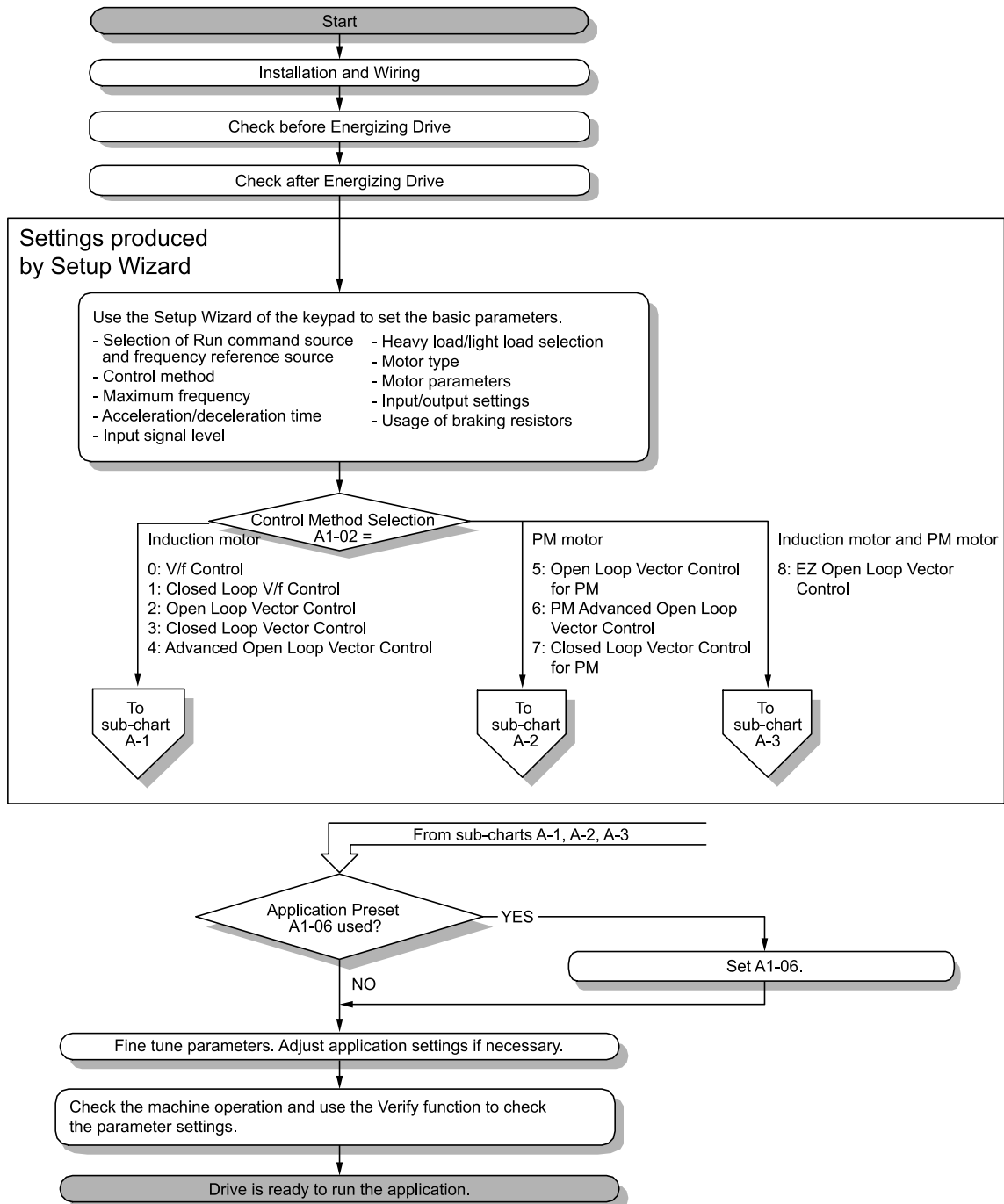


Figure 3.8 Basic Steps before Startup

◆ Sub-Chart A-1: Induction Motor Auto-Tuning and Test Run Procedure

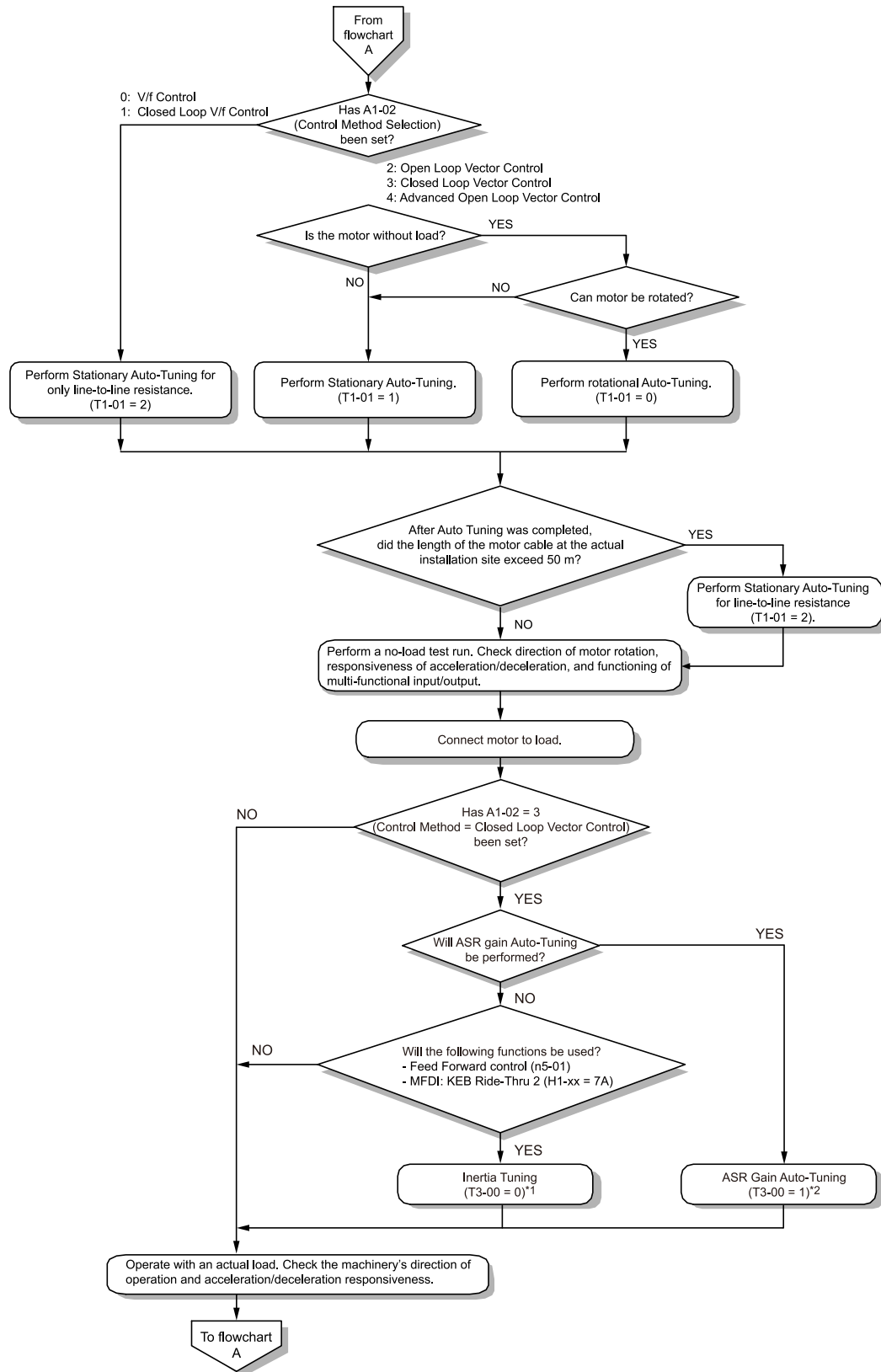


Figure 3.9 Induction Motor Auto-Tuning and Test Run Procedure

\*1 Be sure to release the holding brake before doing Inertia Tuning.

\*2 In ASR Tuning, the drive will automatically tune Feed Forward control and KEB Ride-Thru 2 parameters.

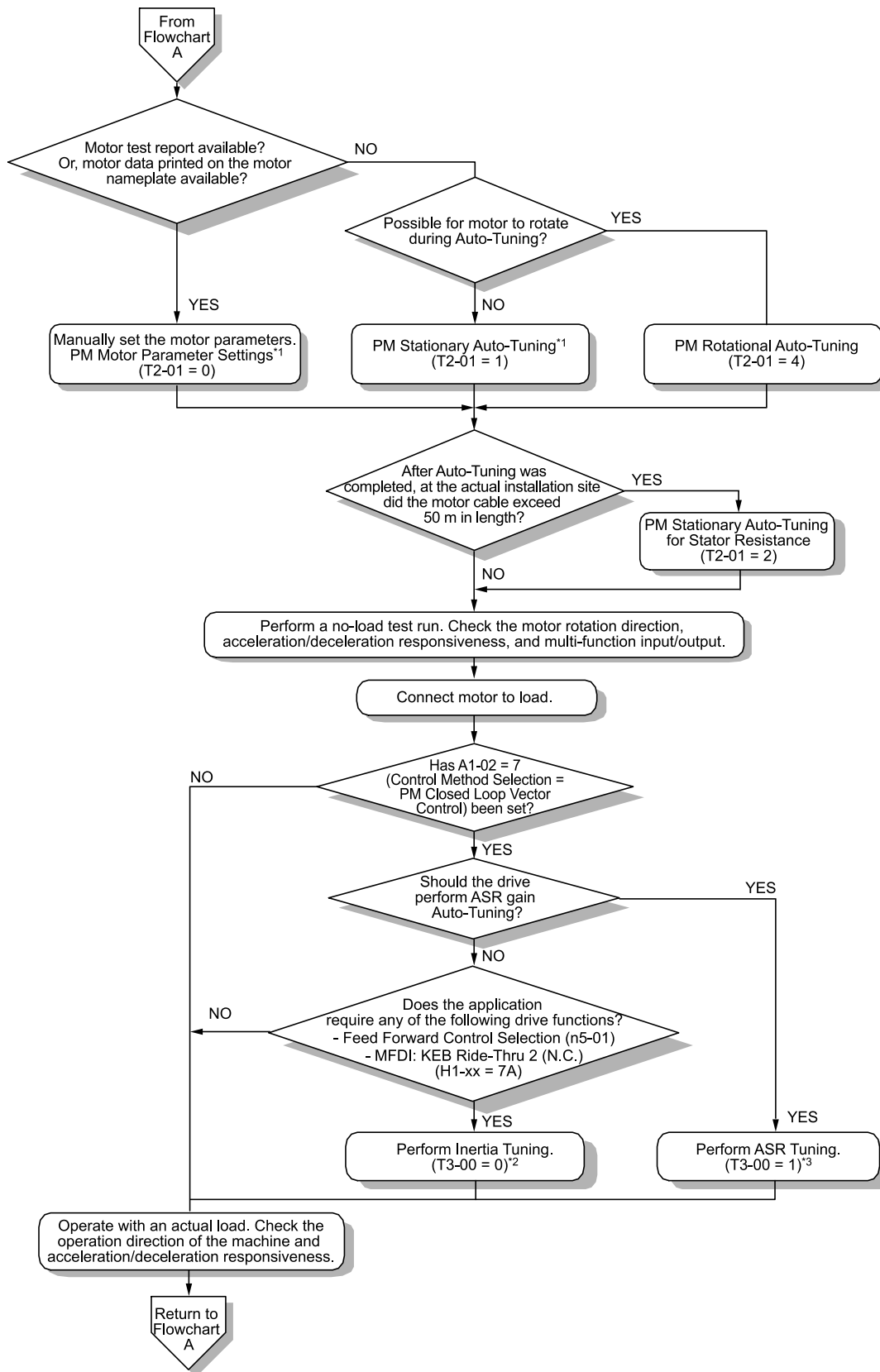
◆ Sub-Chart A-2: PM Motor Auto-Tuning and Test Run Procedure

Sub-Chart A-2 gives the basic steps to start up the drive for a PM motor.

**Note:**

1. Although Auto-Tuning will set parameters for speed control with an encoder, set F1-05 [PG 1 Rotation Selection] before starting Auto-Tuning.
2. If you replace the encoder, do Z Pulse Offset Tuning.

**WARNING! Crash Hazard.** Test the system to make sure that the drive operates safely after you wire the drive and set parameters. Failure to obey can cause injury or damage to equipment.



Startup Procedure and Test Run

3

**Figure 3.10 PM Motor Auto-Tuning and Test Run Procedure**

### 3.4 Start-up Procedures

- \*1 For Yaskawa PM motors (SMRA-series, SSR1-series, or SST4-series), set E5-01 (Motor Code). For PM motors from a different manufacturer, set  $E5-01 = FFFF$ .
- \*2 Be sure to release the holding brake before doing Inertia Tuning.
- \*3 In ASR Tuning, the drive will automatically tune Feed Forward control and KEB Ride-Thru 2 parameters.

#### ◆ Subchart A-3: EZ Open Loop Vector Control Test Run Procedure

Subchart A-3 gives the setup procedure to run a PM motor in EZ Open Loop Vector Control.

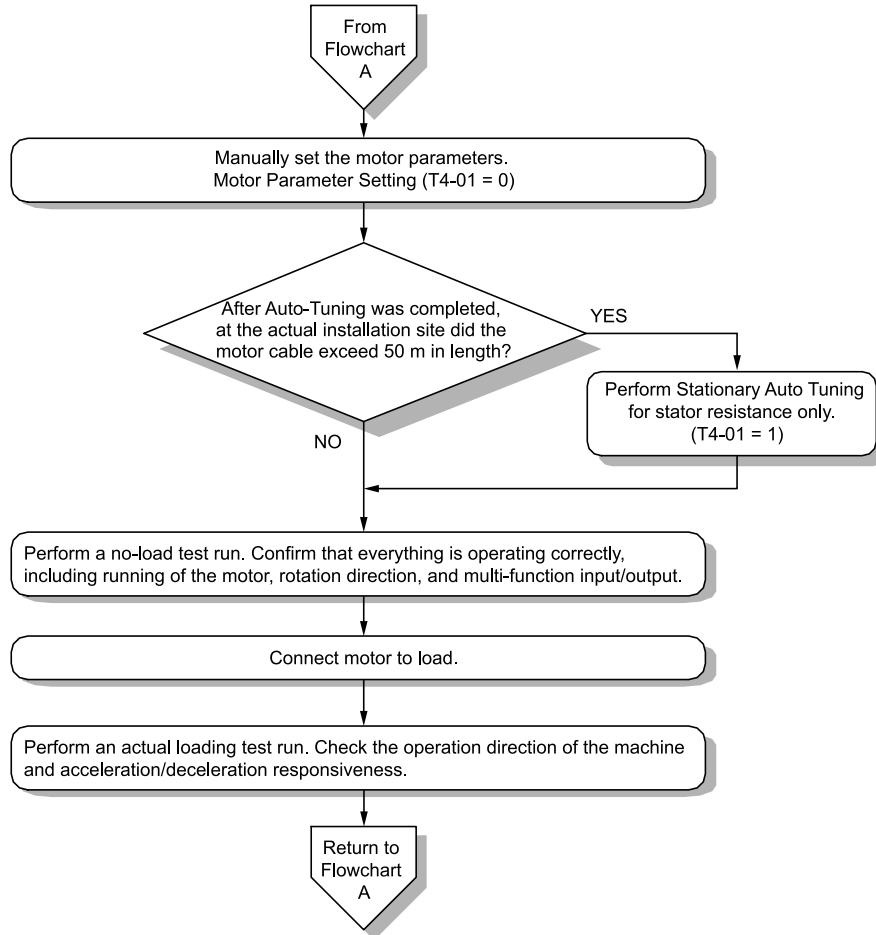


Figure 3.11 Procedure for Test Run of EZ Open Loop Vector Control Method



## 3.5 Items to Check before Starting Up the Drive

### ◆ Check before Energizing the Drive

Check the items in [Table 3.4](#) before energizing the drive.




**Table 3.4 Items to Check before Energizing the Drive**

Items to Check	Description
Input Power Supply Voltage	The voltage of the input power supply must be: 200 V class: three-phase AC 200 V to 240 V 50/60 Hz, DC 270 V to 340 V 400 V class: three-phase AC 380 V to 480 V 50/60 Hz, DC 510 V to 680 V
	Correctly and safely wire power supply input terminals R/L1, S/L2, T/L3.
	Correctly ground the drive and motor.
Connection between Drive Output Terminals and Motor Terminals	Correctly wire drive output terminals (U/T1, V/T2, and W/T3) and motor terminals (U, V, and W), and tighten loose screws.
Control Circuit Terminal Wiring	Turn OFF the inputs from all devices and switches connected to the drive control circuit terminals.
Control Circuit Terminal Status	Turn OFF the inputs from all devices and switches connected to the drive control circuit terminals.
Connection between Machinery and Motor	Disengage all couplings and belts that connect the motor and machinery.

### ◆ Check after Energizing the Drive

Check the items in [Table 3.5](#) after energizing the drive. The keypad will show these screens depending on the drive status.

**Table 3.5 Display Status after Energizing the Drive**

Status	Display	Description
During Usual Operation	10:00 am FWD Init Setup Language Selection Set Date/Time Setup Wizard Show Initial Setup Screen Home	<ul style="list-style-type: none"> <li>The data display area will show the Initial Setup screen or the HOME screen</li> <li>Energize the drive with factory defaults to show the Initial Setup screen. Select [No] from the [Show Initial Setup Screen] settings to show the HOME screen without showing the Initial Setup screen.</li> </ul>
	Initial Setup Screen or 10:00 am FWD Rdy Home Freq Reference (AI) U1-01 Hz 0.00 Output Frequency U1-02 Hz 0.00 Output Current U1-03 A 0.00 JOG Menu FWD/REV HOME Screen	
When the Drive Detects a Fault	10:00 am FWD EF3 External Fault (Terminal S3) RESET Home	<p>The display changes depending on the fault. Refer to "Troubleshooting" to remove the cause of the fault.  will illuminate.</p> <p><b>Note:</b> If the screen shows a different screen, do these steps to show the fault content again:</p> <ol style="list-style-type: none"> <li>Push  from the HOME screen.</li> <li>Push  (Home) from a different screen than the HOME screen.</li> </ol>

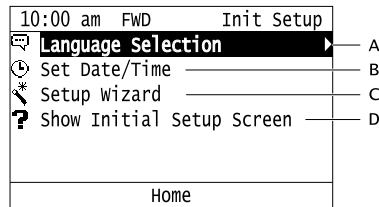
#### ◆ Make the Initial Settings

The keypad will show the Initial Setup screen when energizing the drive for the first time. Users can set the date and time or the language to show on the keypad. The Setup Wizard prepares the drive for operation, from setting the basic parameters to performing Auto-Tuning. Refer to *Set Parameters Using the Setup Wizard on page 181* for more information.

**Note:**

If the keypad does not show the Initial Setup screen, [Initial Setup] from the Main Menu to show the Initial Setup screen.

1. Make the initial settings for each item.



**A - Language Selection**

**C - Setup Wizard**

**B - Set Date/Time**

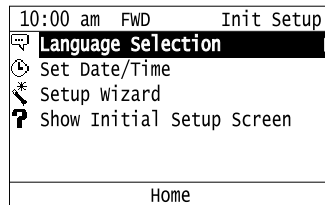
**D - Show Initial Setup Screen**

**Note:**

If you select [Yes] from the [Show Initial Setup Screen] setting, the keypad will show the Initial Setup screen each time the drive is energized.

If you select [NO], the keypad will not show the Initial Setup screen each time the drive is energized, starting with the next time.

2. Push **F2** (Home).



The display shows the HOME screen.

## 3.6 Keypad Operation

### ◆ Use the HOME Screen



The functions that can be controlled from the HOME screen and the content that is displayed are explained in the following.

10:00 am	FWD	Rdy	Home
Freq Reference(AI)			0.00
U1-01	Hz		
Output Frequency			0.00
U1-02	Hz		
Output Current			0.00
U1-03	A		
JOG	Menu	FWD/REV	





### ■ View Monitors Shown in Home Screen

This figure shows monitor data in the data display area of the HOME screen.



10:00 am	FWD	Rdy	Home	
Freq Reference (AI)			0.00	— Monitor
U1-01	Hz			
Output Frequency			0.00	
U1-02	Hz			
Output Current			0.00	
U1-03	A			
JOG	Menu	FWD/REV		


- To change what the screen shows, change the setting for *o1-40 [Home display selection]*.
- When *o1-40 [Home display selection]* is set to “Custom Monitor”, and there is more than one screen, use  or  to switch between screens.

### ■ JOG Operation

Push  to illuminate . Push  (JOG) to run the motor. Release  to stop the motor.

### ■ Change Motor between Forward/Reverse Run



You can change the direction of motor rotation when operating the drive from the keypad. Push  to illuminate .

Push and hold  (FWD/REV) to toggle the direction of motor rotation between forward and reverse.







### ■ Show the Standard Monitor

Push  to show the standard monitor (*Ux-xx*). Push  (HOME) to go back to the HOME screen.

**Note:**

When a fault, minor fault, or an error occurs, push  to show the content of the fault. Push  again to show the standard monitor (*Ux-xx*).

### ■ Change the Frequency Reference Value

1. Push  to access the screen to change the frequency.
2. Push  or  to select the specified digit, then push  or  to change the value.
3. Push  to confirm the change.

**Note:**

The HOME screen must show *U1-01 [Frequency Reference]* or you must set the keypad as the Run command source (REMOTE) to use this function.

#### ■ Show the Main Menu

Push **F2** to show the main menu. Push **F2** (HOME) to go back to the HOME screen.

10:00 am	FWD	Rdy	Menu
Monitors			
Parameters			
User Custom Parameters			
Parameter Backup/Restore			
Modified Param / Fault Log			
Auto-Tuning			
Home			

#### ◆ Show the Standard Monitor

This section shows how to show the standard monitor (Ux-xx).

1. Push **F2** (Home) to show the HOME screen.

**Note:**

- The keypad will show [Home] in the top right corner when the HOME screen is active.
- If [Home] is not shown on **F2**, push **F1** (Back) to show [Home] on **F2**.

2. Push **F2** (Menu).



10:00 am	FWD	Rdy	Home
Freq Reference (AI)			
U1-01	Hz		0.00
Output Frequency			
U1-02	Hz		0.00
Output Current			
U1-03	A		0.00
JOG	Menu	FWD/REV	

3. Push  or  to select [Monitors], then push .



10:00 am	FWD	Rdy	Menu
Monitors			
Parameters			
User Custom Parameters			
Parameter Backup/Restore			
Modified Param / Fault Log			
Auto-Tuning			
Home			

4. Push  or  to select [Standard Monitor], then push .

10:00 am	FWD	Rdy	Monitor
Standard Monitor			
Custom Monitor			
Bar Graph			
Analog Gauge			
Trend Plot			
Back	Home		

5. Push  or  to move the cursor to change the value .

10:00 am	FWD	Rdy	Monitor
Freq Reference (AI)			
U1-01	Hz		0.00
Output Frequency			
U1-02	Hz		0.00
Output Current			
U1-03	A		0.00
Back	Home	FWD/REV	

6. Push  or  to change the monitor number to show the monitor item.

10:00 am	FWD	Rdy	Monitor
Terminal A1 Input Lv			
U1-13	%		0.0
Terminal A2 Input Lv			
U1-14	%		0.0
Terminal A3 Input Lv			
U1-15	%		0.0
Back	Home	FWD/REV	

## ◆ Set Custom Monitors

You can select and register a maximum of 12 monitoring items to regularly show on the keypad. This procedure shows how to set the motor speed to [Custom Monitor 1].

1. Push **F2** (Home) to show the HOME screen.

**Note:**

- The keypad will show [Home] in the top right corner when the HOME screen is active.
- If [Home] is not shown on **F2**, push **F1** (Back) to show [Home] on **F2**.

2. Push **F2** (Menu).

10:00 am	FWD	Rdy	Home
Freq Reference (AI)			0.00
U1-01	Hz		0.00
Output Frequency			0.00
U1-02	Hz		0.00
Output Current			0.00
U1-03	A		0.00
JOG	Menu	FWD/REV	

3. Push **▲** or **▼** to select [Monitors], then push **↵**.

10:00 am	FWD	Rdy	Menu
Monitors			
Parameters			
User Custom Parameters			
Parameter Backup/Restore			
Modified Param / Fault Log			
Auto-Tuning			
Home			

4. Push **▲** or **▼** to select [Custom Monitor], then push **F3** (Setup).

10:00 am	FWD	Rdy	Monitor
Standard Monitor			
Custom Monitor			
Bar Graph			
Analog Gauge			
Trend Plot			
Back	Home	Setup	

5. Push **▲** or **▼** to select [Custom Monitor 1], then push **↵**.

10:00 am	FWD	Setup	
Custom Monitor 1			
Custom Monitor 2			
Custom Monitor 3			
Custom Monitor 4			
Custom Monitor 5			
Custom Monitor 6			
Back	Home		

6. Push **▲** or **▼** to select the monitor number to register, then push **↵**.

Enter the three digits in “x-xx” part of monitor  $U_x-xx$  to identify which monitor to output. For example, to show monitor  $U1-05$ , set it to “105” as shown in this figure.

10:00 am	FWD	Parameters	
Custom Monitor 1			
01-24		<b>105</b>	
Frequency Reference			
Default : 101			
Back	Default		

The configuration procedure is complete.

## ◆ Show Custom Monitors

The procedure in this section shows how to show the registered custom monitors.

1. Push **F2** (Home) to show the HOME screen.

**Note:**

- The keypad will show [Home] in the top right corner when the HOME screen is active.
- If [Home] is not shown on **F2**, push **F1** (Back) to show [Home] on **F2**.

2. Push **F2** (Menu).

10:00 am	FWD	Rdy	Home
Freq Reference (AI)			
U1-01	Hz		0.00
Output Frequency			
U1-02	Hz		0.00
Output Current			
U1-03	A		0.00
JOG	Menu	FWD/REV	

3. Push **▲** or **▼** to select [Monitors], then push **↵**.

10:00 am	FWD	Rdy	Menu
<b>Monitors</b>			
Parameters			
User Custom Parameters			
Parameter Backup/Restore			
Modified Param / Fault Log			
Auto-Tuning			
Home			

4. Push **▲** or **▼** to select [Custom Monitor], then push **↵**.

10:00 am	FWD	Rdy	Monitor
Standard Monitor			
<b>Custom Monitor</b>			
Bar Graph			
Analog Gauge			
Trend Plot			
Back	Home	Setup	

The keypad shows the selected monitor as shown in this figure.

10:00 am	FWD	Rdy	Monitor
Motor Speed			
U1-05	Hz		20.00
Output Power			
U1-08	kw		15.0
Terminal A1 Input Lv			
U1-13	%		30.0
Back	Home	FWD/REV	

- When there are a minimum of two screens, push **▲** or **▼** to switch between screens.
- If you registered only one custom monitor to [Custom Monitor 1], the screen will show only one monitor. If you registered custom monitors only to [Custom Monitor 1] and [Custom Monitor 2], the screen will show only two monitors.

#### ◆ Set the Monitors to Show as a Bar Graph

The procedure in this section shows how to show the frequency reference monitor as a bar graph.

1. Push **F2** (Home) to show the HOME screen.

**Note:**

- The keypad will show [Home] in the top right corner when the HOME screen is active.
- If [Home] is not shown on **F2**, push **F1** (Back) to show [Home] on **F2**.

2. Push **F2** (Menu).

10:00 am	FWD	Rdy	Home
Freq Reference (AI)			
U1-01	Hz		0.00
Output Frequency			
U1-02	Hz		0.00
Output Current			
U1-03	A		0.00
JOG	Menu	FWD/REV	

3. Push  or  to select [Monitors], then push .

10:00 am FWD Rdy Menu
<b>Monitors</b>
Parameters
User Custom Parameters
Parameter Backup/Restore
Modified Param / Fault Log
Auto-Tuning
Home

4. Push  or  to select [Bar Graph], then push **F3** (Setup).

10:00 am FWD Rdy Monitor
Standard Monitor
Custom Monitor
<b>Bar Graph</b>
Analog Gauge
Trend Plot
Back Home Setup

5. Push  or  to select the location to store the monitor, then push .

10:00 am FWD Setup
<b>Custom Monitor 1</b>
Custom Monitor 2
Custom Monitor 3
Back Home

6. Push .

10:00 am FWD Setup
Custom Monitor 1
<b>Custom Monitor 1</b>
01-24 101 (101)
1st Monitor Area Selection
01-41 0 (0)
Back Home

7. Push  or  to select the monitor number to register, then push .

Enter the three digits in "x-xx" part of monitor  $U_x-xx$  to identify which monitor to output. For example, to show monitor  $U1-01$  [Frequency Reference], set it to "101" as shown in this figure.

10:00 am FWD Parameters
Custom Monitor 1
01-24 <b>101</b>
Frequency Reference
Default : 101
Back Default

The configuration procedure is complete.

## ◆ Show Monitors as Bar Graphs

The procedure in this section shows how to show a specific monitor as a bar graph. You can show a maximum of three.

1. Push **F2** (Home) to display the HOME screen.

**Note:**


- [Home] appears in the upper right hand corner of the screen when in HOME mode.
- If [Home] is not shown on **F2**, push **F1** (Back) to show [Home] on **F2**.

2. Push **F2** (Menu).

10:00 am	FWD	Rdy	Home
Freq Reference (AI)			
U1-01	Hz		0.00
Output Frequency			
U1-02	Hz		0.00
Output Current			
U1-03	A		0.00
JOG	Menu	FWD/REV	

3. Push  or  to select [Display Monitor], then push .

10:00 am	FWD	Rdy	Menu
<b>Monitors</b>			
Parameters			
User Custom Parameters			
Parameter Backup/Restore			
Modified Param / Fault Log			
Auto-Tuning			
Home			

4. Push  or  to select [Display Bar Graph], and push .

10:00 am	FWD	Rdy	Monitor
Standard Monitor			
Custom Monitor			
<b>Bar Graph</b>			
Analog Gauge			
Trend Plot			
Back	Home	Setup	

The screen will show the monitors as shown in this figure.

10:00 am	FWD	Rdy	Monitor
U1-01			
40.00Hz	-100%	0%	100%
U1-02			
40.00Hz	-100%	0%	100%
U1-03			
3.0A	-100%	0%	100%
Back	Home	FWD/REV	

## ◆ Set the Monitors to Show as Analog Gauges

The procedure in this section shows how to show the frequency reference monitor as an analog gauge.

1. Push **F2** (Home) to show the HOME screen.

**Note:**

- The keypad will show [Home] in the top right corner when the HOME screen is active.
- If [Home] is not shown on **F2**, push **F1** (Back) to show [Home] on **F2**.

2. Push **F2** (Menu).

10:00 am	FWD	Rdy	Home
Freq Reference (AI)			
U1-01	Hz		0.00
Output Frequency			
U1-02	Hz		0.00
Output Current			
U1-03	A		0.00
JOG	Menu	FWD/REV	

3. Push  or  to select [Monitors], then push .

10:00 am	FWD	Rdy	Menu
<b>Monitors</b>			
Parameters			
User Custom Parameters			
Parameter Backup/Restore			
Modified Param / Fault Log			
Auto-Tuning			
Home			



4. Push  or  to select [Analog Gauge], then push  (Setup).

10:00 am	FWD	Rdy	Monitor
Standard Monitor			
Custom Monitor			
Bar Graph			
<b>Analog Gauge</b>			
Trend Plot			
Back	Home	Setup	

5. Push .

10:00 am	FWD	Setup
Analog Gauge		
<b>Custom Monitor 1</b>		
01-24	101	(101)
Analog Gauge Area Selection		
01-55	1	(1)
Back	Home	

6. Push  or  to select the monitor number to register, then push .


Enter the three digits in "x-xx" part of monitor  $U_x-xx$  to identify which monitor to output. For example, to show monitor  $U1-01$  [Frequency Reference], set it to "101" as shown in this figure.

10:00 am	FWD	Parameters
Custom Monitor 1		
01-24	<b>101</b>	
Frequency Reference		
Default : 101		
Back	Default	




The configuration procedure is complete.

## ◆ Display Monitors as an Analog Gauge

The following explains how to display the contents selected for a monitor as an analog gauge.

1. Push  (Home) to show the HOME screen.

### Note:


- The keypad will show [Home] in the top right corner when the HOME screen is active.
- If [Home] is not on , push  (Back) to show [Home] on .

2. Push  (Menu).

10:00 am	FWD	Rdy	Home
Freq Reference (AI)			
U1-01	Hz		0.00
Output Frequency			
U1-02	Hz		0.00
Output Current			
U1-03	A		0.00
JOG	Menu	FWD/REV	

3. Push  or  to select [Monitors], then push .

10:00 am	FWD	Rdy	Menu
<b>Monitors</b>			
Parameters			
User Custom Parameters			
Parameter Backup/Restore			
Modified Param / Fault Log			
Auto-Tuning			
Home			

4. Push  or  to select [Analog Gauge], then push .

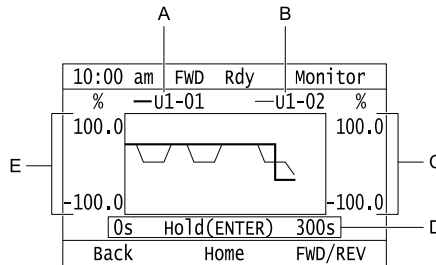
10:00 am FWD Rdy Monitor
Standard Monitor
Custom Monitor
Bar Graph
<b>Analog Gauge</b>
Trend Plot
Back Home Setup

It will be displayed as follows.

10:00 am FWD Rdy Monitor
Output Frequency
50.0
0.0 60.0Hz 100.0
Back Home FWD/REV

### ◆ Set Monitoring Items to be Shown as a Trend Plot


You must set the items in this figure to display as a trend plot.






- A - Monitor Parameter 1 (set with [Custom Monitor 1])
- B - Monitor Parameter 2 (set with [Custom Monitor 2])
- C - Trend Plot 2 Scale Maximum/Minimum Value
- D - Trend Plot Time Scale
- E - Trend Plot 1 Scale Maximum/Minimum Value

### ■ Select Monitor Items to Show as a Trend Plot

The procedure in this section shows how to show the frequency reference monitor as a trend plot.

1. Push  (Home) to show the HOME screen.

**Note:**

- The keypad will show [Home] in the top right corner when the HOME screen is active.
- If [Home] is not shown on , push  (Back) to show [Home] on .

2. Push  (Menu).




10:00 am FWD Rdy Home
Freq Reference (AI)
U1-01 Hz 0.00
Output Frequency
U1-02 Hz 0.00
Output Current
U1-03 A 0.00
JOG Menu FWD/REV

3. Push  or  to select [Monitors], then push .

10:00 am FWD Rdy Menu
<b>Monitors</b>
Parameters
User Custom Parameters
Parameter Backup/Restore
Modified Param / Fault Log
Auto-Tuning
Home

4. Push  or  to select [Trend Plot], then push  (Setup).

10:00 am	FWD	Rdy	Monitor
Standard Monitor			
Custom Monitor			
Bar Graph			
Analog Gauge			
<b>Trend Plot</b> ▶			
Back		Home Setup	

5. Push  or  to select [Custom Monitor 1], then push .

10:00 am	FWD	Setup
<b>Custom Monitor 1</b> ▶		
Custom Monitor 2		
Trend Plot Time Scale Setting		
Back		Home

6. Push .

10:00 am	FWD	Setup
Custom Monitor 1		
<b>Custom Monitor 1</b>		
o1-24	101	(101)
Trend Plot 1 Scale Minimum Value		
o1-47	-100.0	(-100.0)%
Back		Home





7. Push  or  to select the monitor number to register, then push .

When the *U parameters* are on the display as "Ux-xx", the three digits in "x-xx" identify which monitor to output. For example, to show monitor U1-01 [*Frequency Reference*], set it to "101" as shown in this figure.



10:00 am	FWD	Parameters
Custom Monitor 1		
o1-24	<b>101</b>	
Frequency Reference		
Default : 101		
Back		Default


8. Push  or  to select [Trend Plot 1 Scale Minimum Value], then push .

10:00 am	FWD	Setup
Custom Monitor 1		
<b>Trend Plot 1 Scale Minimum Value</b>		
o1-47	-100.0	(-100.0)%
Trend Plot 1 Scale Maximum Value		
o1-48	100.0	( 100.0)%
Back		Home




9. Push  or  to select the specified digit, then push  or  to select the correct number.

10:00 am	FWD	Parameters
Trend Plot 1 Scale Minimum Value		
o1-47	<b>-</b> 100.0 %	
Default : -100.0%		
Range : -300.0~ 99.9		
Back		Default Min/Max





- Push  (Default) to set the parameters to the factory default.
- Push  (Min/Max) to move between the minimum value and maximum value.

10. Push  to keep the changes.



10:00 am	FWD	Parameters
Trend Plot 1 Scale Minimum Value		
o1-47	00	20.0 %
Default : -100.0%		
Range : -300.0~ 99.9		
Back	Default	Min/Max


11. Push  or  to select [Trend Plot 1 Scale Maximum Value], then push .

10:00 am	FWD	Setup
Custom Monitor 1		
Trend Plot 1 Scale Minimum Value		
o1-47	100.0	(-100.0)%
Trend Plot 1 Scale Maximum Value		
o1-48	100.0	( 100.0)%
Back Home		

12. Push  or  to select the specified digit, then push  or  to select the correct number.

10:00 am	FWD	Parameters
Trend Plot 1 Scale Maximum Value		
o1-48	0	100.0 %
Default : 100.0%		
Range : 20.1~ 300.0		
Back	Default	Min/Max

- Push  (Default) to set the parameters to the factory default.
- Push  (Min/Max) to move between the minimum value and maximum value.

13. Push  to keep the changes.


10:00 am	FWD	Parameters
Trend Plot 1 Scale Maximum Value		
o1-48	00	80.0 %
Default : 100.0%		
Range : 20.1~ 300.0		
Back	Default	Min/Max

14. Push  (Back).




If necessary, use the same procedure to set [Custom Monitor 2].

### ■ Set the Time Scale for the Trend Plot Monitor

The procedure in this section shows how to set the time scale for the trend plot monitor.

1. Push  (Home) to show the HOME screen.

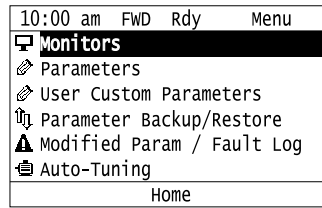
**Note:**

- The keypad will show [Home] in the top right corner when the HOME screen is active.
- If [Home] is not shown on , push  (Back) to show [Home] on .

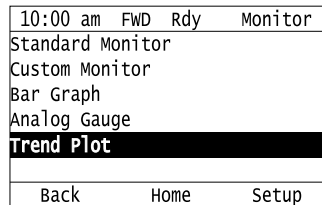
2. Push  (Menu).

10:00 am	FWD	Rdy	Home
Freq Reference (AI)			
U1-01	Hz		0.00
Output Frequency			
U1-02	Hz		0.00
Output Current			
U1-03	A		0.00
JOG	Menu	FWD/REV	

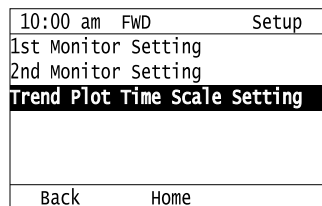
3. Push or to select [Monitors], then push .



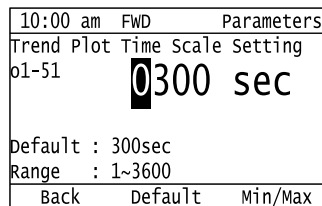
4. Push or to select [Trend Plot], then push (Setup).



5. Push or to select [Trend Plot Time Scale Setting], then push .

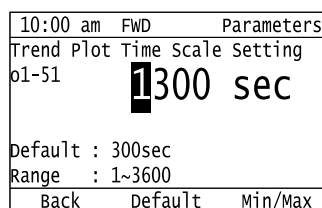


6. Push or to select the specified digit, then push or to select the correct number.



- Push (Default) to set the parameters to the factory default.
- Push (Min/Max) to move between the minimum value and maximum value.

7. Push to keep the changes.



The configuration procedure is complete.

## ◆ Show Monitor Items as a Trend Plot

The procedure in this section shows how to show the selected monitor data as a trend plot.

1. Push (Home) to show the HOME screen.

**Note:**

- The keypad will show [Home] in the top right corner when the HOME screen is active.
- If [Home] is not shown on , push (Back) to show [Home] on .

2. Push **F2** (Menu).

10:00 am	FWD	Rdy	Home
Freq Reference (AI)			
U1-01	Hz		0.00
Output Frequency			
U1-02	Hz		0.00
Output Current			
U1-03	A		0.00
JOG	Menu	FWD/REV	

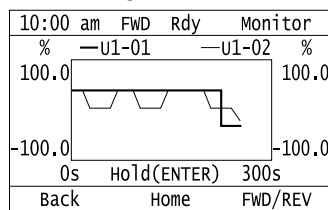
3. Push  or  to select [Monitors], then push .

10:00 am	FWD	Rdy	Menu
<b>Monitors</b>			
Parameters			
User Custom Parameters			
Parameter Backup/Restore			
Modified Param / Fault Log			
Auto-Tuning			
Home			


4. Push  or  to select [Trend Plot], then push .

10:00 am	FWD	Rdy	Monitor
Standard Monitor			
Custom Monitor			
Bar Graph			
Analog Gauge			
<b>Trend Plot</b>			
Back Home Setup			

The screen will show the monitors as shown in this figure.



**Note:**

Push  (Hold) to switch between Pause and Restart for the monitor display. The "Hold (ENTER)" message flashes while monitoring is paused.

## ◆ Change Parameter Settings

Do the steps in this procedure to set parameters for the application. This example shows how to change the setting value for *C1-01 [Acceleration Time 1]*.

1. Push **F2** (Home) to show the HOME screen.

**Note:**

- When the drive is in HOME Mode, the screen shows [Home] in the upper right-hand corner of the screen.
- If [Home] is not on **F2**, push **F1** (Back).

2. Push **F2** (Menu).

10:00 am	FWD	Rdy	Home
Freq Reference (AI)			
U1-01	Hz		0.00
Output Frequency			
U1-02	Hz		0.00
Output Current			
U1-03	A		0.00
JOG	Menu	FWD/REV	

3. Push  or  to select [Parameters], then push .




10:00 am FWD	Menu
Monitors	
<b>Parameters</b>	
User Custom Parameters	
Parameter Backup/Restore	
Modified Param / Fault Log	
Auto-Tuning	
Home	

4. Push  or  to select [C Tuning], then push .





10:00 am FWD	Parameters
A Initialization Parameters	
b Application	
<b>C Tuning</b>	
d References	
E Motor Parameters	
F Options	
Back	Home

5. Push  or  to select [C1 Accel & Decel Time], then push .



10:00 am FWD	Parameters
<b>C1 Accel &amp; Decel Time</b>	
C2 S-Curve Characteristics	
C3 Slip Compensation	
C4 Torque Compensation	
C6 Duty & Carrier Frequency	
Back	Home


6. Push  or  to select C1-01, then push .

10:00 am FWD	Parameters
Acceleration Time 1	
<b>C1-01 10.0 (10.0)sec</b>	
Deceleration Time 1	
C1-02 10.0 (10.0)sec	
Acceleration Time 2	
C1-03 10.0 (10.0)sec	
Back	Home


7. Push  or  to select the specified digit, then push  or  to select the correct number.

10:00 am FWD	Parameters
Acceleration Time 1	
C1-01 <b>00</b> 10.0sec	
Default : 10.0sec	
Range : 0.0~6000.0	
Back	Default Min/Max

- Push  [Default] to set the parameters to factory defaults.
- Push  [Min/Max] to show the minimum value or the maximum value on the display.

8. Push  to keep the changes.

10:00 am FWD	Parameters
Acceleration Time 1	
C1-01 00 <b>2</b> 0.0 sec	
Default : 10.0 sec	
Range : 0.0~6000.0	
Back	Default Min/Max

9. Continue to change parameters, then push  [Back] to go back to the home screen after you change all the applicable parameters.

## ◆ Examine User Custom Parameters

The User Custom Parameters show the parameters set in A2-01 to A2-32 [User Parameter 1 to User Parameter 32]. This lets users to quickly access and change settings to these parameters.

**Note:**

The User Custom Parameters always show A1-06 [Application Selection] at the top of the list. The A2-01 to A2-32 settings change when the A1-06 setting changes, which makes it easier to set and reference the necessary parameter settings.

1. Push **F2** (Home) to show the HOME screen.

**Note:**

- The keypad will show [Home] in the top right corner when the HOME screen is active.
- If [Home] is not shown on **F2**, push **F1** (Back) to show [Home] on **F2**.

2. Push **F2** (Menu).

10:00 am	FWD	Rdy	Home
Freq Reference (AI)			
U1-01	Hz		0.00
Output Frequency			
U1-02	Hz		0.00
Output Current			
U1-03	A		0.00
JOG	Menu	FWD/REV	

3. Push **▲** or **▼** to select [User Custom Parameters], then push **↵**.

10:00 am	FWD	Menu
Monitors		
Parameters		
<b>User Custom Parameters</b>		
Parameter Backup/Restore		
Modified Param / Fault Log		
Auto-Tuning		
Home		

4. Push **▲** or **▼** to show the parameter to examine.

10:00 am	FWD	Parameters
Application Preset		
A1-06	0	(0)
Control Method Selection		
A1-02	2	(2)
Frequency Reference Selection 1		
b1-01	1	(1)
Back	Home	


5. To change the parameter settings, push **▲** or **▼** to select the parameter, then push **↵**.

10:00 am	FWD	Parameters
Application Preset		
A1-06	0	(0)
<b>Control Method Selection</b>		
<b>A1-02</b>	<b>2</b>	<b>(2)</b>
Frequency Reference Selection 1		
b1-01	1	(1)
Back	Home	

6. Push **◀** or **▶** to select the digit, then push **▲** or **▼** to change the value.

10:00 am	FWD	Parameters
Control Method Selection		
A1-02	<b>2</b>	
Open Loop Vector Control		
Default : 2		
Back	Default	



7. Change the value, push .

10:00 am	FWD	Parameters
Control Method Selection		
A1-02		0
V/f Control		
Default : 2		
Back	Default	


The parameter setting procedure is complete.

## ◆ Save a Backup of Parameters




You can save a backup of the drive parameters to the keypad. The keypad can store parameter setting values for a maximum of four drives in different storage areas. Making backups of the parameter settings can save time when setting parameters after replacing a drive. If you set up more than one drive, you can copy the parameter settings from a drive that completed a test run to the other drives.

### Note:

- Always stop the motor before making a backup of the parameters.
- When making a backup, the drive will not accept Run commands.

1. Push  (Home) to show the HOME screen.

### Note:




- The keypad will show [Home] in the top right corner when the HOME screen is active.
- If [Home] is not shown on , push  (Back) to show [Home] on .

2. Push  (Menu).

10:00 am	FWD	Rdy	Home
Freq Reference (AI)			
U1-01	Hz		0.00
Output Frequency			
U1-02	Hz		0.00
Output Current			
U1-03	A		0.00
JOG	Menu	FWD/REV	

3. Push  or  to select [Parameter Backup/Restore], then push .




10:00 am	FWD	Menu
Monitors		
Parameters		
User Custom Parameters		
Parameter Backup/Restore		
Modified Param / Fault Log		
Auto-Tuning		
Home		

4. Push  or  to select the items to back up, then push .

10:00 am	FWD	Backup
Select Items to Backup/Restore		
Standard Parameters		
Back		
Home		

5. Push  or  to select [Backup (drive → keypad)], then push .

10:00 am	FWD	Backup
Select Desired Action		
Backup (drive → keypad)		
Restore (keypad → drive)		
Verify (check for mismatch)		
Erase (backup data of keypad)		
Back		
Home		

6. Push  or  to select a memory location, then push .

10:00 am	FWD	Backup
Select Backup/Restore Location		
#1	No Data	▶
#2	No Data	
#3	No Data	
#4	No Data	
Back	Home	


The keypad shows “End” when the backup procedure completes successfully.

## ◆ Write Backed-up Parameters to the Drive




You can back up parameters on the keypad and write them to different drives.

**Note:**

- Always stop the drive before you start to restore the parameter backups.
- The drive rejects Run commands while it is restoring parameters.

1. Push  (Home) to show the HOME screen.



**Note:**




- The keypad will show [Home] in the top right corner when the HOME screen is active.
- If [Home] is not shown on , push  (Back) to show [Home] on .

2. Push  (Menu).

10:00 am	FWD	Rdy	Home
Freq Reference (AI)			
U1-01	Hz		0.00
Output Frequency			
U1-02	Hz		0.00
Output Current			
U1-03	A		0.00
JOG	Menu	FWD/REV	

3. Push  or  to select [Parameter Backup/Restore], then push .

10:00 am	FWD	Menu
Monitors		
Parameters		
User Custom Parameters		
 Parameter Backup/Restore	▶	
 Modified Param / Fault Log		
Auto-Tuning		
Home		

4. Push  or  to select the item to restore, then push .

10:00 am	FWD	Backup
Select Items to Backup/Restore		
Standard Parameters		
▶		
Back	Home	

5. Push  or  to select [Restore (keypad → drive)], then push .

10:00 am	FWD	Backup
Select Desired Action		
Backup (drive → keypad)		
Restore (keypad → drive)		
▶		
Verify (check for mismatch)		
Erase (backup data of keypad)		
Back	Home	

6. Push  or  to select the backed-up parameter data, then push .

10:00 am	FWD	Backup
Select Backup/Restore Location		
#1	2016/01/01 13:00	0-62
#2	No Data	
#3	No Data	
#4	No Data	
Back		Home

The keypad will show the "End" message when the write process is complete.

**Note:**

Different settings and conditions will change the keypad display.

		A	B	C
	10:00 am	FWD	Backup	
	Select Backup/Restore Location			
	#1	2016/01/01 14:10	0-62	
F	#2	2016/01/01 02:10pm	1-62	*
E	#3	----/--/-- --:--	2-62	*
D	#4	No Data		
Back		Home		


- A - A1-02 [Control Method Selection] settings**      **D - Parameter backup data is not registered**  
**B - o2-04 [Drive Model (KVA) Selection] settings (2 or 3 digits)**      **E - Backup data does not contain the date information**  
**C - Presence of DriveWorksEZ parameter backup**      **F - Backup date**

## ◆ Verify Keypad Parameters and Drive Parameters




This procedure verifies that the parameter setting values that were backed up in the keypad agree with the parameter setting values in the drive.

**Note:**

- Always stop the drive before you start to verify the parameters.
- The drive does not accept Run commands while restoring parameters.

1. Push  (Home) to show the HOME screen.

**Note:**




- The keypad will show [Home] in the top right corner when the HOME screen is active.
- If [Home] is not shown on , push  (Back) to show [Home] on .

2. Push  (Menu).




10:00 am	FWD	Rdy	Home
Freq Reference (AI)			
U1-01	Hz		0.00
Output Frequency			
U1-02	Hz		0.00
Output Current			
U1-03	A		0.00
JOG		Menu	
		FWD/REV	

3. Push  or  to select [Parameter Backup/Restore], then push .




10:00 am	FWD	Menu
Monitors		
Parameters		
User Custom Parameters		
Parameter Backup/Restore		
Modified Param / Fault Log		
Auto-Tuning		
Home		

4. Push  or  to select the item to verify, then push .

10:00 am	FWD	Backup
Select Items to Backup/Restore		
Standard Parameters ▶		
Back	Home	

5. Push  or  to select [Verify (check for mismatch)], then push .

10:00 am	FWD	Backup
Select desired action.		
Backup (drive → keypad)		
Restore (keypad → drive)		
Verify (check for mismatch) ▶		
Erase (backup data of keypad)		
Back	Home	

6. Push  or  to select the data to verify, then push .

10:00 am	FWD	Backup
Select Backup/Restore Location		
#1 2016/01/01 13:00 0-62 ▶		
#2 No Data		
#3 No Data		
#4 No Data		
Back	Home	


The keypad shows “End” when the parameter settings backed up in the keypad agree with the parameter settings copied to the drive.

**Note:**




The keypad shows *vFyE [Parameters do not Match]* when the parameter settings backed up in the keypad do not agree with the parameter settings copied to the drive. Push one of the keys to return to the screen in Step 6.

## ◆ Delete Parameters Backed Up to the Keypad

This procedure deletes the parameters that were backed up to the keypad.

1. Push  (Home) to show the HOME screen.

**Note:**




- The keypad will show [Home] in the top right corner when the HOME screen is active.
- If [Home] is not shown on , push  (Back) to show [Home] on .

2. Push  (Menu).

10:00 am	FWD	Rdy	Home
Freq Reference (AI)			
U1-01	Hz		0.00
Output Frequency			
U1-02	Hz		0.00
Output Current			
U1-03	A		0.00
JOG	Menu	FWD/REV	

3. Push  or  to select [Parameter Backup/Restore], then push .




10:00 am	FWD	Menu
Monitors		
Parameters		
User Custom Parameters		
Parameter Backup/Restore ▶		
Modified Param / Fault Log		
Auto-Tuning		
Home		

4. Push  or  to select the item to delete, then push .

10:00 am	FWD	Backup
Select Items to Backup/Restore		
Standard Parameters ▶		
Back	Home	

5. Push  or  to select [Delete], then push .

10:00 am	FWD	Backup
Select desired action.		
Backup (drive → keypad)		
Restore (keypad → drive)		
Verify (check for mismatch)		
Erase (backup data of keypad) ▶		
Back	Home	


6. Push  or  to select the data to delete, then push .

10:00 am	FWD	Backup
Select Backup/Restore Location		
#1 2016/01/01 14:10 0-62 ▶		
#2 2016/01/01 02:10pm 1-62		
#3 ----/--/-- --:-- 2-62		
#4 No Data		
Back	Home	




The keypad will show the “End” message when the write process is complete.

## ◆ Check Modified Parameters

This procedure will show all parameters that were changed from their defaults as the result of Auto-Tuning or setting changes. This helps find which settings have been changed, and is very useful when you replace a drive. This lets users quickly access and re-edit changed parameters. If no parameters have been changed, the keypad will show “0 Parameters”.

1. Push  (Home) to show the HOME screen.

### Note:

- The keypad will show [Home] in the top right corner when the HOME screen is active.
- If [Home] is not shown on , push  (Back) to show [Home] on .




2. Push  (Menu).


10:00 am	FWD	Rdy	Home
Freq Reference (AI)			
U1-01	Hz		0.00
Output Frequency			
U1-02	Hz		0.00
Output Current			
U1-03	A		0.00
JOG	Menu	FWD/REV	


3. Push  or  to select [Modified Param / Fault Log], then push .



10:00 am	FWD	Menu
Monitors		
Parameters		
User Custom Parameters		
Parameter Backup/Restore		
▲ Modified Param / Fault Log ▶		
Auto-Tuning		
Home		

4. Push  or  to select [Modified Parameters], then push .

10:00 am	FWD	History
 Modified Parameters 		
 Fault Log		
<hr/>		
Back	Home	

5. Push .





10:00 am	FWD	Modified
User Modified Parameters		
<b>Standard Parameters</b> 		
<b>2 Parameters</b>		
<hr/>		
Back	Home	

6. Push  or  to show the parameter to check.


10:00 am	FWD	Modified
<b>Acceleration Time 1</b>		
<b>c1-01</b>	<b>20.0</b>	<b>(10.0)sec</b>
Motor Rated Current (FLA)		
E2-01	97.2	(77.2)A
<hr/>		
Back	Home	

7. To re-edit a parameter, push  or , select the parameter to edit, then push .

10:00 am	FWD	Modified
<b>Acceleration Time 1</b>		
<b>c1-01</b>	<b>20.0</b>	<b>(10.0)sec</b>
Motor Rated Current (FLA)		
E2-01	97.2	(77.2)A
<hr/>		
Back	Home	

8. Push  or  to select the digit, then push  or  to change the value.

10:00 am	FWD	Parameters
Acceleration Time 1		
c1-01	<b>00</b> 20.0	sec
Default : 10.0sec		
Range : 0.0~6000.0		
Back	Default	Min/Max

9. When you are done changing the value, push .

10:00 am	FWD	Parameters
Acceleration Time 1		
c1-01	00 <b>30</b> .0	sec
Default : 10.0sec		
Range : 0.0~6000.0		
Back	Default	Min/Max

The parameter revision procedure is complete.

### ◆ Restore Modified Parameters to Defaults

This procedure will set all parameters with changed values to their default settings.

1. Push **F2** (Home) to show the HOME screen.

**Note:**

- The keypad will show [Home] in the top right corner when the HOME screen is active.
- If [Home] is not shown on **F2**, push **F1** (Back) to show [Home] on **F2**.

2. Push **F2** (Menu).

10:00 am	FWD	Rdy	Home
Freq Reference (AI)			0.00
U1-01	Hz		0.00
Output Frequency			0.00
U1-02	Hz		0.00
Output Current			0.00
U1-03	A		0.00
JOG	Menu	FWD/REV	

3. Push **▲** or **▼** to select [Modified Param / Fault Log], then push **↵**.

10:00 am	FWD	Menu
Monitors		
Parameters		
User Custom Parameters		
Parameter Backup/Restore		
<b>Modified Param / Fault Log</b>		
Auto-Tuning		
Home		

4. Push **▲** or **▼** to select [Modified Parameters], then push **↵**.

10:00 am	FWD	History
<b>Modified Parameters</b>		
Fault Log		
Back Home		

5. Push **↵**.


10:00 am	FWD	Modified
User Modified Parameters		
<b>Standard Parameters</b>		
2 Parameters		
Back Home		

6. Push **▲** or **▼** to select the parameters to return to their default settings, then push **↵**.

10:00 am	FWD	Modified
<b>Acceleration Time 1</b>		
<b>C1-01</b>	20.0	(10.0)sec
Motor Rated Current (FLA)		
E2-01	97.2	(77.2)A
Back Home		

7. Push **F2** (Default).

10:00 am	FWD	Parameters
Acceleration Time 1		
C1-01	<b>0020.0</b>	sec
Default :	10.0sec	
Range :	0.0~6000.0	
Back	Default	Min/Max

8. Push .

10:00 am	FWD	Parameters
Acceleration Time 1		
C1-01	0010.0	sec
Default : 10.0sec		
Range : 0.0~6000.0		
Back	Default	Min/Max


The modified parameters are now set to default values.

## ◆ Show Fault History




You can examine a maximum of 10 fault codes and dates and times that the faults occurred.

**Note:**

- Make sure that you first set the date and time on the keypad if you will monitor the date and time of the faults.
- If the keypad does not have a clock battery, you must set the date and time each time you energize the drive.



1. Push  (Home) to show the HOME screen.

**Note:**

- The keypad will show [Home] in the top right corner when the HOME screen is active.
- If [Home] is not shown on , push  (Back) to show [Home] on .

2. Push  (Menu).



10:00 am	FWD	Rdy	Home
Freq Reference (AI)			
U1-01	Hz		0.00
Output Frequency			
U1-02	Hz		0.00
Output Current			
U1-03	A		0.00
JOG	Menu	FWD/REV	

3. Push  or  to select [Modified Parameters/Fault History], then push .

10:00 am	FWD	Menu
Monitors		
Parameters		
User Custom Parameters		
Parameter Backup/Restore		
▲ Modified Param / Fault Log ▶		
Auto-Tuning		
Home		

4. Push  or  to select [Fault History], then push .

10:00 am	FWD	History
Modified Parameters		
▲ Fault Log ▶		
Back Home		

5. Push  or  to show the fault history you will examine.

10:00 am	FWD	History
Fault History Log		
01 ov	2016/01/01 14:00	Overvoltage
02 oc	2016/01/01 14:00	Overcurrent
Back Home		

## ◆ Auto-Tuning the Drive

Auto-Tuning uses motor characteristics to automatically set drive parameters.

Refer to the motor nameplate or the motor test report for the necessary information for Auto-Tuning.



VARTSPEED									
3-PHASE PERMANENT MAGNET MOTOR									
TYPE SST4-					POLES E5-04				
PROTECTION					COOLING				
kw	V	Hz	RATING	A	r/min	r <sub>i</sub>	E5-05		
E5-02	E1-05			E5-03	E1-04,06	Ld	E5-06		
						Lq	E5-07		
						Ke	E5-09		
TNS. COOLANT TEMP.		°C		ALTITUDE		m	Δθ	E5-11	
STD		MASS		Kg		Δθ'			
BRG NO	DRIVE END	OPP END		YEAR		Ki			
SER NO	YEAR		YEAR		Kt				
YASKAWA ELECTRIC CORPORATION					JAPAN		Si		

Figure 3.12 Motor Nameplate (Example)

**WARNING! Sudden Movement Hazard.** Remove all persons and objects from the area around the drive, motor, and load before starting Auto-Tuning. The drive and motor can start suddenly during Auto-Tuning and cause death or serious injury.

**WARNING! Electrical Shock Hazard.** When doing Stationary Auto-Tuning, the motor will receive high voltage when the motor is stopped. Do not touch the motor until Auto-Tuning is completed. Failure to obey can cause injury or death from electrical shock.

**NOTICE:** Rotational Auto-Tuning will not function correctly if a holding brake is engaged on the load. Make sure that the motor can freely spin before starting Auto-Tuning. Failure to obey could cause incorrect operation of the drive.

**NOTICE:** Do not do Rotational Auto-Tuning with the load connected to the motor. Uncouple the load from the motor. Failure to obey can cause incorrect operation. The drive cannot accurately calculate motor parameters if the load is connected to the motor while doing Rotational Auto-Tuning, and the drive will not operate the motor correctly.

This procedure shows how to do Rotational Auto-Tuning.

1. Push **F2** (Home) to show the HOME screen.

**Note:**

- The keypad will show [Home] in the top right corner when the HOME screen is active.
- If [Home] is not shown on **F2**, push **F1** (Back) to show [Home] on **F2**.

2. Push **F2** (Menu).

10:00 am	FWD	Rdy	Home
Freq Reference (AI)			
U1-01	Hz		0.00
Output Frequency			
U1-02	Hz		0.00
Output Current			
U1-03	A		0.00
JOG	Menu	FWD/REV	

3. Push **▲** or **▼** to select [Auto-Tuning], then push **↵**.

10:00 am	FWD	Menu
Parameters		
User Custom Parameters		
Parameter Backup/Restore		
Modified Param / Fault Log		
<b>Auto-Tuning</b>	▶	
Initial Setup		
Home		






4. Push **↵**.

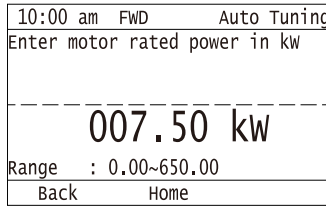
10:00 am	FWD	Auto Tuning
Select Auto-Tuning mode		
<b>Motor Parameter Tuning</b>	▶	
Back	Home	


5. Push **▲** or **▼** to select [Rotational Auto-Tuning], then push **↵**.

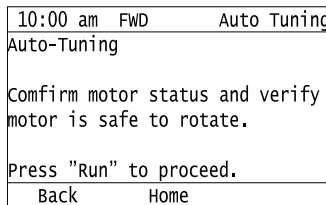
10:00 am	FWD	Auto Tuning
Select Auto-Tuning method		
<b>Rotational Auto-Tuning</b>	▶	
Stationary Auto-Tuning		
Stationary Line-Line Resistance		
Back	Home	

6. Follow the messages shown on the keypad to input the necessary Auto-Tuning data.

Example: Push  or  to select the specified digit, then push  or  to change the number, then push  to save the changes and continue to the next entry field.





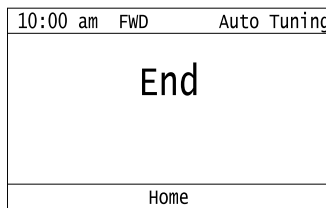
- Follow the messages shown on the keypad to do the next steps.
- When the keypad shows the Auto-Tuning start screen, push .






Auto-Tuning starts.

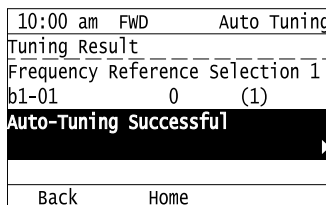
When doing Rotational Auto-Tuning, the motor will stay stopped for approximately one minute with power energized and then the motor will start to rotate.




- When the keypad shows the this screen after Auto-Tuning is complete for 1 or 2 minutes, push  or .



The keypad will show a list of the changed parameters as the result of Auto-Tuning.


- Push  or  in the parameter change confirmation screen to check the changed parameters, then select [Auto-Tuning Successful] at the bottom of the screen and push .

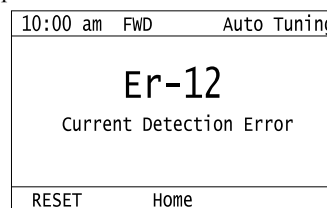
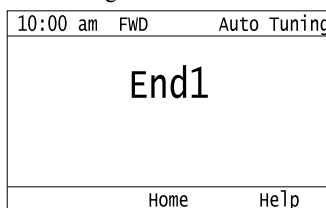


To change a parameter again, push  or  to select the parameter to change then push  to show the Parameter setting screen.

Auto-Tuning is complete.

**Note:**

If the drive detects an error or you push  before Auto-Tuning is complete, Auto-Tuning will stop and the keypad will show an error code. *Endx* identifies that Auto-Tuning was successful with calculation errors. Find and repair the cause of the error and do Auto-Tuning again, or set the motor parameters manually. You can use the drive in the application if you cannot find the cause of the *Endx* error. *Er-xx* identifies that Auto-Tuning was not successful. Find and repair the cause of the error and do Auto-Tuning again.



## ◆ Set the Keypad Language Display

The procedure in this section shows how to set the language shown on the keypad.

1. Push **F2** (Home) to show the HOME screen.

**Note:**

- The keypad will show [Home] in the top right corner when the HOME screen is active.
- If [Home] is not shown on **F2**, push **F1** (Back), to show [Home] on **F2**.

2. Push **F2** (Menu).

10:00 am	FWD	Rdy	Home
Freq Reference (AI)			0.00
U1-01	Hz		0.00
Output Frequency			0.00
U1-02	Hz		0.00
Output Current			0.00
U1-03	A		0.00
JOG	Menu	FWD/REV	

3. Push **▲** or **▼** to select [Initial Settings], then push **↵**.

10:00 am	FWD	Menu
✎	User Custom Parameters	
🔄	Parameter Backup/Restore	
⚠	Modified Param / Fault Log	
🔧	Auto-Tuning	
☰	<b>Initial Setup</b>	▶
🔧	Diagnostic Tools	
Home		

4. Push **▲** or **▼** to select [Language Selection], then push **↵**.

10:00 am	FWD	Init Setup
🗨	<b>Language Selection</b>	▶
🕒	Set Date/Time	
🔧	Setup Wizard	
?	Show Initial Setup Screen	
Back Home		

5. Push **▲** or **▼** to select the language, then push **↵**.

10:00 am	FWD	Init Setup
Language Selection		
<b>English</b>		
Japanese		
Deutsch		
Frangais		
Italiano		
Back Home		

The procedure to set the keypad language is complete.

## ◆ Set the Date and Time

The procedure in this section shows how to set the date and time.

**Note:**

- Refer to [Replace the Keypad Battery on page 437](#) for information about the battery installation procedure.  
To set the drive to detect an alarm when the battery is dead or when the clock is not set, install the battery then set  $o4-24 = 1$  [bAT Detection selection = Enable (Alarm Detected)].
- If the keypad does not have a clock battery, you must set the date and time each time you energize the drive.

1. Push **F2** (Home) to show the HOME screen.

**Note:**




- The keypad will show [Home] in the top right corner when the HOME screen is active.
- If [Home] is not shown on **F2**, push **F1** (Back) to show [Home] on **F2**.

2. Push **F2** (Menu).




10:00 am	FWD	Rdy	Home
Freq Reference (AI)			
U1-01	Hz		0.00
Output Frequency			
U1-02	Hz		0.00
Output Current			
U1-03	A		0.00
JOG	Menu	FWD/REV	

3. Push  or  to select [Initial Setup], then push .




10:00 am	FWD	Menu
User Custom Parameters		
Parameter Backup/Restore		
Modified Param / Fault Log		
Auto-Tuning		
<b>Initial Setup</b>		
Diagnostic Tools		
Home		

4. Push  or  to select [Set Date/Time], and push .

10:00 am	FWD	Init Setup
Language Selection		
<b>Set Date/Time</b>		
Setup Wizard		
Show Initial Setup Screen		
Back	Home	

5. Push  or  to select the format of date display, then push .


10:00 am	FWD	Init Setup
<b>YYYY/MM/DD (2016/01/01)</b>		
DD/MM/YYYY (01/01/2016)		
MM/DD/YYYY (01/01/2016)		
Back	Home	

6. Push  or  to select the format of time display, then push .





10:00 am	FWD	Init Setup
24 hour clock (00:00)		
<b>12 hour EA clock (00:00 am)</b>		
12 hour JP clock (00:00 am)		
Back	Home	

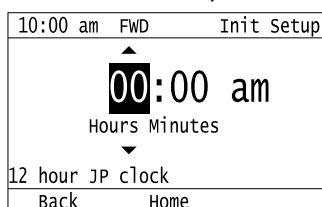
7. Push  or  to select a number from Year/Month/Day, then push  or  to change the value.


10:00 am	FWD	Init Setup
20 <b>16</b> /01/01		
Year Month Day		
YYYY/MM/DD		
Back	Home	

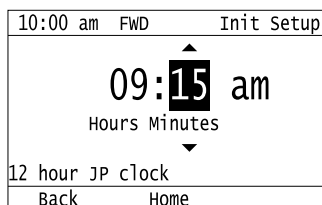
8. When you are done changing the value, push .

10:00 am	FWD	Init Setup
2016/ <b>04</b> /01		
Year Month Day		
YYYY/MM/DD		
Back	Home	

9. Push  or  to select the hour or minute, then push  or  to change the value.



10. When you are done setting the time, push .



The procedure for setting the date and time is complete.


## ◆ Set Parameters Using the Setup Wizard

The Setup Wizard lets users follow simple messages on the keypad to set these basic parameters:




- Frequency reference source
- Input signal level
- Run command source
- Duty Rating
- Motor type
- Control method
- Maximum frequency
- Input/output settings

### Note:

The Setup Wizard function will initialize all parameters before it sets the basic parameters.

1. Push  (Home) to show the HOME screen.







### Note:




- The keypad will show [Home] in the top right corner when the HOME screen is active.
- If [Home] is not shown on , push  (Back) to show [Home] on .

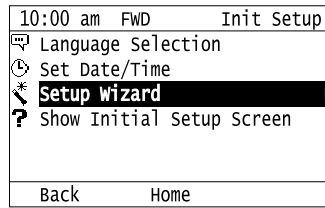
2. Push  (Menu).




10:00 am	FWD	Rdy	Home
Freq Reference (AI)			
U1-01	Hz		0.00
Output Frequency			
U1-02	Hz		0.00
Output Current			
U1-03	A		0.00
JOG	Menu	FWD/REV	

3. Push  or  to select [Initial Setup], then push .

10:00 am	FWD	Menu
	User Custom Parameters	
	Parameter Backup/Restore	
	Modified Param / Fault Log	
	Auto-Tuning	
	<b>Initial Setup</b>	
	Diagnostic Tools	
Home		

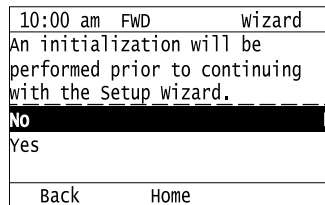
4. Push  or  to select [Setup Wizard], then push .






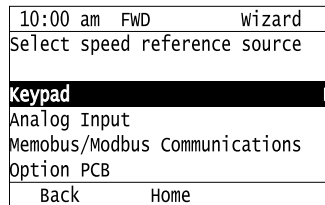
5. Push  or  to select [Yes], then push .

**Note:**

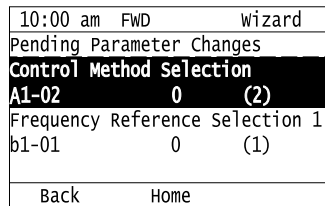
This operation will initialize all parameters.






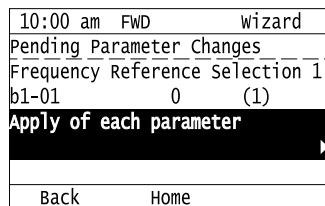
6. Push  or  to select the item to set, then push .






7. For the next steps, follow the instructions shown on the keypad until the “Parameter Change Confirmation Screen” is shown.






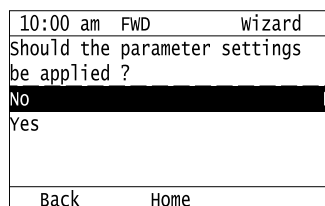
8. In the parameter change confirmation screen, push  or  to examine the changed parameter, then select [Apply of each parameter] at the bottom of the screen and push .



**Note:**

To change a parameter again, push  or  to select the parameter to change, then push  to show the parameter setting screen.

9. Push  or  to select [Yes], then push .



The Setup Wizard procedure is complete.

## ◆ Disable the Initial Setup Screen

Do the steps in this procedure to not show the initial start-up screen when the drive is energized.

1. Push **F2** (Home) to show the HOME screen.







**Note:**

- When the drive is in HOME Mode, the screen shows [Home] in the upper right-hand corner of the screen.
- If the screen does not show [Home] for **F2**, push **F1** (Back), and then push **F2** to show [Home].





2. Push **F2** (MENU).




10:00 am	FWD	Rdy	Home
Freq Reference (AI)			
U1-01	Hz		0.00
-----			
Output Frequency			
U1-02	Hz		0.00
-----			
Output Current			
U1-03	A		0.00
-----			
JOG	Menu	FWD/REV	

3. Push  /  to select [Initial Setup], then push .

10:00 am	FWD	Menu
	User Custom Parameters	
	Parameter Backup/Restore	
	Modified Param / Fault Log	
	Auto-Tuning	
	<b>Initial Setup</b>	
	Diagnostic Tools	
-----		
Home		

4. Push  /  to select [Show Initial Setup Screen], then push .

10:00 am	FWD	Init Setup
	Language Selection	
	Set Date/Time	
	Setup Wizard	
	<b>Show Initial Setup Screen</b>	
-----		
Back	Home	

5. Push  /  to select [No], then push .

10:00 am	FWD	Init Setup
Show Initial Setup Screen		
-----		
No		
<b>Yes</b>		
-----		
Back	Home	

- [No]: The keypad will not show the Initial Setup Screen when the drive is energized.
- [Yes]: The keypad will show the Initial Setup Screen when the drive is energized.

## ◆ Start Data Logging

The data log function keeps a record of a maximum of 10 drive monitors. The procedure in this section shows how to start logging data.


1. Make sure that a microSD card is inserted in the keypad.
2. Push **F2** (Home) to show the HOME screen.








**Note:**

- The keypad will show [Home] in the top right corner when the HOME screen is active.
- If [Home] is not shown on **F2**, push **F1** (Back) to show [Home] on **F2**.


3. Push **F2** (Menu).

10:00 am	FWD	Rdy	Home
Freq Reference (AI)			
U1-01	Hz		0.00
Output Frequency			
U1-02	Hz		0.00
Output Current			
U1-03	A		0.00
JOG	Menu	FWD/REV	


4. Push  or  to select [Diagnostic Tools], then push .

10:00 am	FWD	Menu
	User Custom Parameters	
	Parameter Backup/Restore	
	Modified Param / Fault Log	
	Auto-Tuning	
	Initial Setup	
	<b>Diagnostic Tools</b>	
Home		

5. Push  or  to select [Data Logger], then push .


10:00 am	FWD	Tools
<b>Data Logger</b>		
Backlight		
Drive Information		
Back	Home	Setup

6. Push  or  to select [Yes] or [No], then push .

10:00 am	FWD	Tools
Begin Data Logging?		
<b>Yes</b>		
No		
Back	Home	

- [Yes]: Data logging starts.
- [No]: Data logging will not start.

If the drive was logging data when you entered the command, the keypad look like this:

10:00 am	FWD	Tools
End Data Logging?		
<b>Yes</b>		
No		
Start Time : 2016/01/01 00:00		
Period : 00:10:00		
Back	Home	

## ◆ Set Data to Log

### ■ Set Monitor to Log

The procedure in this section shows how to set the monitor for which to log data.

1. Push **F2** (Home) to show the HOME screen.



**Note:**







- The keypad will show [Home] in the top right corner when the HOME screen is active.
- If [Home] is not shown on **F2**, push **F1** (Back) to show [Home] on **F2**.



2. Push **F2** (Menu).

10:00 am	FWD	Rdy	Home
Freq Reference (AI)			
U1-01	Hz		0.00
Output Frequency			
U1-02	Hz		0.00
Output Current			
U1-03	A		0.00
JOG	Menu	FWD/REV	

3. Push  or  to select [Diagnostic Tools], then push .

10:00 am	FWD	Menu	
	User Custom Parameters		
	Parameter Backup/Restore		
	Modified Param / Fault Log		
	Auto-Tuning		
	Initial Setup		
	<b>Diagnostic Tools</b>		
Home			

4. Push  or  to select [Data Logger], then push **F3** (Setup).

10:00 am	FWD	Tools	
<b>Data Logger</b>			
Backlight			
Drive Information			
Back	Home	Setup	

5. Push  or  to select [Log Monitor], then push .

10:00 am	FWD	Setup	
<b>Log Monitor</b>			
Log Sampling Interval			
Back	Home		

6. Push  or  to select the save-destination monitor parameter, then push .

10:00 am	FWD	Setup	
Log Monitor			
<b>Log Monitor Data 1</b>			
o5-03	101	(101)	
Log Monitor Data 2			
o5-04	102	(102)	
Back	Home		

7. Push  or  to select the monitor number to be logged, then push .

10:00 am	FWD	Parameters	
Log Monitor Data 1			
o5-03		<b>101</b>	
Freq Reference			
Default : 101			
Back	Default		

The setting procedure is complete.

## ■ Set the Sampling Time

The procedure in this section shows how to set the sampling time for data logging.




1. Push **F2** (Home) to show the HOME screen.

### Note:

- The keypad will show [Home] in the top right corner when the HOME screen is active.
- If [Home] is not shown on **F2**, push **F1** (Back) to show [Home] on **F2**.

2. Push **F2** (Menu).

10:00 am	FWD	Rdy	Home
Freq Reference (AI)			
U1-01	Hz		0.00
Output Frequency			
U1-02	Hz		0.00
Output Current			
U1-03	A		0.00
JOG	Menu	FWD/REV	

3. Push  or  to select [Diagnostic Tools], then push .





10:00 am	FWD	Menu
User Custom Parameters		
Parameter Backup/Restore		
Modified Param / Fault Log		
Auto-Tuning		
Initial Setup		
<b>Diagnostic Tools</b>		
Home		

4. Push  or  to select [Data Logger], then push **F3** (Setup).


10:00 am	FWD	Tools
<b>Data Logger</b>		
Backlight		
Drive Information		
Back	Home	Setup

5. Push  or  to select [Log Sampling Interval], then push .

10:00 am	FWD	Setup
Log Monitor		
<b>Log Sampling Interval</b>		
Back		
Home		

6. Push  or  to select the digit, then push  or  to change the value.

10:00 am	FWD	Parameters
Log Sampling Interval		
05-02	<b>0</b>	1000 ms
Default : 1000ms		
Range : 100~60000		
Back	Default	Min/Max

7. When you are done changing the value, push .

10:00 am	FWD	Parameters
Log Sampling Interval		
05-02	<b>20</b>	0000 ms
Default : 1000ms		
Range : 100~60000		
Back	Default	Min/Max

The procedure to set the sampling time is complete.

#### ◆ Set Backlight to Automatically Turn OFF

You can set the backlight of the keypad screen to automatically turn OFF after a set length of time since the last key operation on the keypad. The procedure in this section shows how to turn ON and turn OFF the backlight.

1. Push **F2** (Home) to show the HOME screen.







**Note:**

- The keypad will show [Home] in the top right corner when the HOME screen is active.
- If [Home] is not shown on **F2**, push **F1** (Back) to show [Home] on **F2**.

2. Push **F2** (Menu).


10:00 am	FWD	Rdy	Home
Freq Reference (AI)			0.00
U1-01	Hz		0.00
Output Frequency			0.00
U1-02	Hz		0.00
Output Current			0.00
U1-03	A		0.00
JOG	Menu	FWD/REV	

3. Push  or  to select [Diagnostic Tools], then push .

10:00 am	FWD	Menu	
	User Custom Parameters		
	Parameter Backup/Restore		
	Modified Param / Fault Log		
	Auto-Tuning		
	Initial Setup		
	<b>Diagnostic Tools</b>	▶	
	Home		

4. Push  or  to select [Backlight], then push .

10:00 am	FWD	Tools	
Data Logger			
	<b>Backlight</b>	▶	
Drive Information			
Back	Home	Setup	

5. Push  or  to select [ON] or [OFF], then push .

10:00 am	FWD	Tools	
LCD backlight ON/OFF Selection			
OFF			
	<b>ON</b>	▶	
Back	Home		

- [ON]: Backlight is always ON
- [OFF]: Backlight turns OFF after set length of time.

6. Push **F3** (Setup).

10:00 am	FWD	Tools	
Data Logger			
	<b>Backlight</b>	▶	
Drive Information			
Back	Home	Setup	

7. Push .

10:00 am	FWD	Setup	
Energy Saving			
<b>Time to turn off LCD backlight</b>			
o1-38	60	(60)sec	
Back	Home		

8. Push or to select the digit, then push or to change the value.

10:00 am	FWD	Parameters
Time to turn off LCD backlight		
01-38	<b>060</b>	sec
Default : 60sec		
Range : 10~300		
Back	Default	Min/Max

9. When you are done changing the value, push .

10:00 am	FWD	Parameters
Time to turn off LCD backlight		
01-38	<b>030</b>	sec
Default : 60sec		
Range : 10~300		
Back	Default	Min/Max

The procedure to set the backlight to turn OFF automatically is complete.

### ◆ Show Information about the Drive

The procedure in this section shows how to show the drive model, maximum applicable motor output (HD/ND), rated output current (HD/ND), software version, and the serial number on the keypad.

1. Push (Home) to show the HOME screen.

**Note:**

- The keypad will show [Home] in the top right corner when the HOME screen is active.
- If [Home] is not shown on , push (Back) to show [Home] on .

2. Push (Menu).

10:00 am	FWD	Rdy	Home
Freq Reference (AI)			
U1-01	Hz		<b>0.00</b>
-----			
Output Frequency			
U1-02	Hz		<b>0.00</b>
-----			
Output Current			
U1-03	A		<b>0.00</b>
JOG	Menu	FWD/REV	

3. Push or to select [Diagnostic Tools], then push .

10:00 am	FWD	Menu
User Custom Parameters		
Parameter Backup/Restore		
Modified Param / Fault Log		
Auto-Tuning		
Initial Setup		
<b>Diagnostic Tools</b> ▶		
Home		

4. Push or to select [Drive Information], then push .

10:00 am	FWD	Tools
Data Logger		
Backlight		
<b>Drive Information</b> ▶		
Back	Home	

The keypad will show the drive information.



## 3.7 Automatic Parameter Settings Optimized for Specific Applications (Application Presets)

The drive has application presets to set the necessary parameters for different applications to their best values. Use *A1-06* from [User Custom Parameters] on the Main menu to check the parameters that were automatically changed by the application preset function.

**Note:**

Make sure that you set *A1-03* = 2220, 3330 [Initialize Parameters = 2-Wire Initialization, 3-Wire Initialization] to initialize parameters before you set *A1-06*.

This section shows the procedure to set an application preset.

1. Push **F2** (Home) to show the HOME screen.

**Note:**

- The keypad will show [Home] in the top right corner when the HOME screen is active.
- If [Home] is not shown on **F2**, push **F1** (Back) to show [Home] on **F2**.

2. Push **F2** (Menu).




10:00 am	FWD	Rdy	Home
Freq Reference (AI)			
U1-01	Hz		0.00
Output Frequency			
U1-02	Hz		0.00
Output Current			
U1-03	A		0.00
JOG	Menu	FWD/REV	

3. Push  or  to select [Parameters], then push .




10:00 am	FWD	Menu
Monitors		
<b>Parameters</b>		
User Custom Parameters		
Parameter Backup/Restore		
Modified Param / Fault Log		
Auto-Tuning		
Home		

4. Push  or  to select [A Initialization Parameters], then push .




10:00 am	FWD	Parameters
<b>A Initialization Parameters</b>		
b Application		
C Tuning		
d References		
E Motor Parameters		
F Options		
Back	Home	

5. Push  or  to select [A1 Initialization], then push .

10:00 am	FWD	Parameters
<b>A1 Initialization</b>		
A2 User Parameters		
Back	Home	

6. Push  or  to select *A1-06*, then push .

10:00 am	FWD	Parameters
Password		
A1-04	0	(0)
<b>Application Preset</b>		
A1-06	1	(0)
DriveWorksEZ Function Selection		
A1-07	0	(0)
Back	Home	

7. Push  or  to change the value, then push .

10:00 am FWD	Parameters
Application Preset	
A1-06	<b>3</b>
Exhaust fan	
Default : 0	
Back	Default

The parameter setting procedure is complete.

**Note:**

- For hoist applications, make sure that you do Auto-Tuning after you set *A1-06*.
- You cannot change the value set in *A1-06*. To select an application preset, first set *A1-03* = 2220 to initialize parameters and then make a selection to *A1-06*. If initializing all parameters will cause a problem, it is not necessary to change settings.
- When the drive changes to the *A1-06* setting, it will also reset the parameters automatically registered to *A2-17* to *A2-32* [*User Parameters 17 to 32*] when *A2-33* = 1 [*User Parameter Auto Selection = Enabled: Auto Save Recent Params*].

## 3.8 Auto-Tuning

Auto-Tuning uses motor characteristics to automatically set drive parameters for vector control. Think about the type of motor, drive control method, and the motor installation environment and select the best Auto-Tuning method.

The keypad will show the messages with prompts to input the necessary parameter information. These prompts are specified by the selected Auto-Tuning method and the control method setting in A1-02.

**WARNING! Crush Hazard.** Rotational Auto-Tuning rotates the motor at a frequency that is 50% or more of the rated frequency of the motor. Make sure that there are no issues related to safety in the area around the drive and motor. Failure to obey can cause death or serious injury and damage to machinery.

### ◆ Auto-Tuning for Induction Motors

This section gives information about Auto-Tuning for induction motors. Set these parameters for Auto-Tuning:

- Motor parameters E1-xx, E2-xx (E3-xx, E4-xx for motor 2)
- Speed feedback detection-use F1-xx (only with CLV)

**Note:**

Do Stationary Auto-Tuning if you cannot do Rotational Auto-Tuning. There can be large differences between the measured results and the motor characteristics when Auto-Tuning is complete. Examine the parameters for the measured motor characteristics after you do Stationary Auto-Tuning.

**Table 3.6 Types of Auto-Tuning for Induction Motors**

Type	Parameter Settings	Application Conditions and Benefits	Applicable Control Method (A1-02 Value)				
			V/f (0)	CL-V/f (1)	OLV (2)	CLV (3)	AOLV (4)
Rotational Auto-Tuning	T1-01 = 0	<ul style="list-style-type: none"> <li>• When you can decouple the motor and load the motor can rotate freely while Auto-Tuning.</li> <li>• When operating motors that have fixed output characteristics.</li> <li>• When it is necessary to use motors that have high-precision control.</li> <li>• When you cannot decouple the motor and load, but the motor load is less than 30%.</li> </ul>	x	x	x	x	x
Stationary Auto-Tuning 1	T1-01 = 1	<ul style="list-style-type: none"> <li>• When you cannot decouple the motor and load, but the motor load is more than 30%.</li> <li>• When the information from the motor test report or motor nameplate is not available.</li> </ul> <p><b>Note:</b> With Stationary Auto-Tuning, the energized drive stays stopped for approximately 1 minute. During this time, the drive automatically measures the necessary motor parameters.</p> <ul style="list-style-type: none"> <li>• When operating the motor with a light load after Auto-Tuning. The drive can automatically calculate the motor parameter settings necessary for torque control. Set T1-12 = 1 [Test Mode Selection = Yes] to do a test run after Auto-Tuning.</li> </ul>	-	-	x	x	x
Line-to-Line Resistance	T1-01 = 2	<ul style="list-style-type: none"> <li>• After Auto-Tuning, the wiring distance between the drive and motor changed by 50 m or more.</li> <li>• When the wiring distance is 50 m or more in the V/f Control mode.</li> <li>• When the motor output and drive capacity are different.</li> </ul>	x	x	x	x	x



## ■ Input Data for Induction Motor Auto-Tuning

To do Auto-Tuning, input data for the items in Table 3.7 that have an "x". Before starting Auto-Tuning, record the information on the motor nameplate as a reference.

Table 3.7 Input Data for Induction Motor Auto-Tuning

Input Data	Parameters	Unit	Auto-Tuning Mode (T1-01 Value)		
			Rotational Auto-Tuning (0)	Stationary Auto-Tuning 1 (1)	Stationary Line-Line Resistance (2)
Motor Rated Power	T1-02	kW	x	x	x
Motor Rated Voltage	T1-03	V	x	x	-
Motor Rated Current	T1-04	A	x	x	x
Motor Base Frequency	T1-05	Hz	x	x	-
Number of Poles	T1-06	-	x	x	-
Motor Base Speed	T1-07	min <sup>-1</sup>	x	x	-
Encoder Pulse Count (PPR)	T1-08	-	x *1	x *1	-
Motor No-Load Current	T1-09	A	-	x	-
Motor Rated Slip Frequency	T1-10	Hz	-	x *2	-
Motor Iron Loss	T1-11	W	x *3	-	-
Test Mode Selection *4	T1-12	-	-	x *5	-
No-Load Voltage	T1-13	V	x *6	x *6	-

\*1 Input this value when A1-02 = 3 [Control Method Selection = Closed Loop Vector].

\*2 0 Hz is displayed as the initial value. If you do not know the Motor Rated Slip Frequency, keep the setting at 0 Hz.

\*3 Input this value when A1-02 = 0 or 1 [Control Method Selection = V/f Control or V/f Control with Encoder].

\*4 If T1-12 = 1 [Test Mode Selection = Yes], when you run the motor in Drive Mode for the first time after Auto-Tuning, the drive will automatically set E2-02 [Motor Rated Slip] and E2-03 [Motor No-Load Current].

\*5 Input this value when T1-10 [Motor Rated Slip Frequency] = 0 Hz.

\*6 Set the same value to No-Load Voltage as T1-03 [Motor Rated Voltage] to get the same characteristics using Yaskawa 1000-Series drives or other legacy models.

## ◆ Auto-Tuning for PM Motors

This section gives information about Auto-Tuning for PM motors. Set these parameters for Auto-Tuning:

- Motor parameters E1-xx, E5-xx
- Speed feedback detection uses F1-xx (only with CLV/PM)

**Table 3.8 Auto-Tuning for PM Motors**

Method	Parameter Settings	Applicable When/Advantages	Applicable Control Method (A1-02 Value)		
			OLV/PM (5)	AOLV/PM (6)	CLV/PM (7)
PM Motor Parameter Settings	T2-01 = 0	<ul style="list-style-type: none"> <li>When the information from the motor test report or motor nameplate is not available.</li> <li>Rotational/Stationary Auto-Tuning that energizes the motor is not done. Manually input the necessary motor parameters.</li> </ul>	x	x	x
PM Stationary Auto-Tuning	T2-01 = 1	<ul style="list-style-type: none"> <li>When the information from the motor test report or motor nameplate is not available.</li> </ul> <p><b>Note:</b> With Stationary Auto-Tuning, the energized drive stays stopped for approximately 1 minute. During this time, the drive automatically measures the necessary motor parameters.</p>	x	x	x
PM Stationary Auto-Tuning for Stator Resistance	T2-01 = 2	<ul style="list-style-type: none"> <li>After Auto-Tuning, the wiring distance between the drive and motor changed by 50 m or more.</li> <li>When the motor output and drive capacity are different.</li> </ul>	x	x	x
Z Pulse Offset Tuning	T2-01 = 3	<ul style="list-style-type: none"> <li>When you do not know the encoder Z-pulse offset.</li> <li>When the encoder was replaced</li> <li>If you have compensated for the deviation from Z phase (<math>\Delta\theta</math>).</li> </ul> <p><b>Note:</b> The motor will rotate slowly while the drive measures the encoder base position.</p>	-	-	x
PM Rotational Auto-Tuning	T2-01 = 4	<ul style="list-style-type: none"> <li>When the information from the motor test report or motor nameplate is available.</li> <li>When you can decouple the motor and load the motor can rotate freely while Auto-Tuning. Values measured during Auto-Tuning are automatically set to the motor parameters.</li> </ul>	x	x	x

■ **Input Data for PM Motor Auto-Tuning**

To do Auto-Tuning, input data for the items in Table 3.9 and Table 3.10 that have an "x". Before starting Auto-Tuning, prepare the motor test report or record the information on the motor nameplate as a reference.

**Table 3.9 Input Data for PM Motor Auto-Tuning**

Input Data	Parameters	Unit	Auto-Tuning Method (T2-01 Value)					
			PM Motor Parameter Settings (0)			PM Stationary Auto-Tuning (1)		PM Stationary Auto-Tuning for Stator Resistance (2)
Control method	A1-02	-	5, 6, 7	5	6, 7	5	6, 7	5, 6, 7
PM Motor Code Selection	T2-02	-	Motor code of Yaskawa motor *1	FFFF *2	FFFF *2	-	-	-
PM Motor Type	T2-03	-	-	-	-	x	x	-
PM Motor Rated Power	T2-04	kW	-	x	x	x	x	-

Input Data	Parameters	Unit	Auto-Tuning Method (T2-01 Value)					
			PM Motor Parameter Settings (0)			PM Stationary Auto-Tuning (1)		PM Stationary Auto-Tuning for Stator Resistance (2)
Control method	A1-02	-	5, 6, 7	5	6, 7	5	6, 7	5, 6, 7
PM Motor Code Selection	T2-02	-	Motor code of Yaskawa motor *1	FFFF *2	FFFF *2	-	-	-
PM Motor Rated Voltage	T2-05	V	-	x	x	x	x	-
PM Motor Rated Current	T2-06	A	-	x	x	x	x	x
PM Motor Base Frequency	T2-07	Hz	-	x	-	x	-	-
Number of PM Motor Poles	T2-08	-	-	x	x	x	x	-
PM Motor Base Speed	T2-09	min <sup>-1</sup>	-	-	x	-	x	-
PM Motor Stator Resistance	T2-10	Ω	x	x	x	-	-	-
PM Motor d-Axis Inductance	T2-11	mH	x	x	x	-	-	-
PM Motor q-Axis Inductance	T2-12	mH	x	x	x	-	-	-
Induced Voltage Const Unit Select	T2-13	-	x	x	x	-	-	-
PM Motor Induced Voltage Const	T2-14	*3	x	x	x	-	-	-
Pull-In Current Lv for PM Motor Tun	T2-15	%	-	-	-	x	x	-
PG Num Of Pulses/Rev for PM Motor Tun	T2-16	-	*4	-	*4	-	*4	-
Encoder Z-Pulse Offset for PM Motor	T2-17	Degrees	*4	-	*4	-	*4	-

\*1 Set the motor code for a Yaskawa PM motor.

\*2 Set the motor code to FFFF for a PM motor from a different manufacturer.

\*3 Changes when the value set in T2-13 changes.

\*4 Input this value when A1-02 = 7 [Control Method Selection = PM Closed Loop Vector Control].

Table 3.10 Input Data for PM Motor Auto-Tuning

Input Data	Parameters	Unit	Auto-Tuning Method (T2-01 Value)			
			Z Pulse Offset Tuning (3)	PM Rotational Auto-Tuning (4)		
Control method	A1-02	-	7	5	6	7
PM Motor Code Selection	T2-02	-	-	-	-	-
PM Motor Type	T2-03	-	-	x	x	x
PM Motor Rated Power	T2-04	kW	-	x	x	x
PM Motor Rated Voltage	T2-05	V	-	x	x	x
PM Motor Rated Current	T2-06	A	-	x	x	x
PM Motor Base Frequency	T2-07	Hz	-	x	-	-

Input Data	Parameters	Unit	Auto-Tuning Method (T2-01 Value)			
			Z Pulse Offset Tuning (3)	PM Rotational Auto-Tuning (4)		
Control method	A1-02	-	7	5	6	7
PM Motor Code Selection	T2-02	-	-	-	-	-
Number of PM Motor Poles	T2-08	-	-	x	x	x
PM Motor Base Speed	T2-09	min <sup>-1</sup>	-	-	x	x
PM Motor Stator Resistance	T2-10	Ω	-	-	-	-
PM Motor d-Axis Inductance	T2-11	mH	-	-	-	-
PM Motor q-Axis Inductance	T2-12	mH	-	-	-	-
InducedVoltage Const Unit Select	T2-13	-	-	-	-	-
PM Motor Induced Voltage Const	T2-14	*1	-	-	-	-
Pull-InCurrentLv forPM Motor Tun	T2-15	%	-	x	x	x
PGNumOfPulses/Rev forPMMotor Tun	T2-16	-	-	-	-	x
Encoder Z-Pulse Offset for PM Motor	T2-17	Degrees	-	-	-	-

\*1 Changes when the value set in T2-13 changes.

### ◆ EZ Tuning

This section gives information about the Auto-Tuning mode for EZ Open Loop Vector Control. Auto-Tuning will set the E9-xx parameters.

Table 3.11 EZ Tuning Mode Selection

Mode	Parameter Settings	Application Conditions and Benefits	Applicable Control Method (A1-02 Value)
Motor Parameter Setting	T4-01 = 0	<ul style="list-style-type: none"> <li>For efficient operation of induction motors and PM motors.</li> <li>For derating torque applications, for example fans and pumps.</li> </ul>	EZOLV (8)
Line-to-Line Resistance	T4-01 = 1	<ul style="list-style-type: none"> <li>After Auto-Tuning, the wiring distance between the drive and motor changed by 50 m or more.</li> <li>When the motor output and drive capacity are different.</li> </ul>	EZOLV (8)

### ■ Input Data for EZ Tuning

To do Auto-Tuning, input data for the items in Table 3.12 that have an "x". Before starting Auto-Tuning, prepare the motor test report or record the information on the motor nameplate as a reference.

Table 3.12 Input Data for EZ Tuning

Input Data	Parameters	Unit	Auto-Tuning Mode (T4-01 Value)	
			Motor Parameter Setting (0)	Line-to-Line Resistance (1)
Motor Type Selection	T4-02	-	x	-
Motor Max Revolutions	T4-03	min <sup>-1</sup>	x	-
Motor Rated Revolutions	T4-04	min <sup>-1</sup>	x	-
Motor Rated Frequency	T4-05	Hz	x	-
Motor Rated Voltage	T4-06	V	x	-
Motor Rated Current	T4-07	A	x	x
Motor Rated Capacity	T4-08	kW	x	-
Number of Poles	T4-09	-	x	-

## ◆ Control Tuning

To increase drive responsiveness and prevent hunting, use Auto-Tuning to automatically adjust the control-related parameters.

These types of Auto-Tuning are available for the control system:

- Inertia Tuning
- ASR Tuning
- Deceleration Rate Tuning
- KEB Tuning

### Note:

If you do Control Tuning, you cannot set  $H1-xx = 16$  [Motor 2 Selection]. Do not do Control Tuning for applications that switch between motor 1 and motor 2.

Table 3.13 Control Loop Tuning Selection

Mode	T3-00	Application Conditions and Benefits	Applicable Control Method (A1-02 Value)								
			V/f (0)	CL-V/f (1)	OLV (2)	CLV (3)	AOLV (4)	OLV/ PM (5)	AOLV/ PM (6)	CLV/ PM (7)	EZOL V (8)
Inertia Tuning	0	<ul style="list-style-type: none"> <li>• For Feed Forward Control</li> <li>• When <math>L2-29 = 1</math> [Kinetic Energy Backup Method = Single Drive KEB Ride-Thru 2].</li> <li>• When MFDI <math>H1-xx = 7A</math> [KEB Ride-Thru 2 Activate (N.C.)].</li> </ul>	-	-	-	x	-	-	-	x	-
ASR Tuning	1	To let the set response frequency (including Inertia Tuning) automatically adjust the ASR gain.	-	-	-	x	-	-	-	x	-
Deceleration Rate Tuning	2	To automatically adjust the deceleration rate to prevent an <i>ov</i> [Overvoltage] fault.	x	x	x	x	x	x	x	x	x
KEB Tuning	3	<ul style="list-style-type: none"> <li>• To automatically adjust parameter settings to prevent an <i>ov</i> [Overvoltage] fault with the KEB Ride-Thru function.</li> <li>• When <math>L3-11 = 1</math> [Overvoltage Suppression Select = Enabled].</li> </ul>	x	x	x	x	x	x	x	x	x

Table 3.14 Input Data for Control Tuning

Input Data	Parameters	Unit	Auto-Tuning Mode (T3-00 Value)			
			Inertia Tuning (0)	ASR (Speed Regulator) (1)	Dec Rate Tuning (2)	KEB Tuning (3)
Test Signal Frequency	T3-01	Hz	x	x	-	-
Test Signal Amplitude	T3-02	Rad	x	x	-	-
Motor Inertia	T3-03	Kg·m <sup>2</sup>	x	x	-	-
System Response Frequency	T3-04	Hz	-	x	-	-

### ■ Inertia Tuning

Inertia Tuning uses the motor speed and torque reference to estimate the system inertia and automatically sets the drive parameters related to the inertia ratio of the machinery and motor. Use Inertia Tuning for Feed Forward control or when  $H1-xx = 7A$  [*MFDI Function Select = KEB Ride-Thru 2 Activate (N.C.)*].

Inertia tuning identifies the load inertia and optimizes the speed loop gain and feed forward gain to get a high level of control capability. You can set the speed response without thinking about the load, which increases the precision when synchronizing multiple drives. Since the motor can continue to operate during a power outage, Inertia Tuning keeps the best ramp to stop deceleration curve for KEB Ride-Thru.

### ■ ASR Tuning

ASR Tuning estimates the motor load inertia and automatically sets the parameters. ASR Tuning also uses the measured load inertia value to do an automatic adjustment after calculating the proportional gain of speed control (ASR).

### ■ Deceleration Rate Tuning

Deceleration Rate Tuning automatically sets the deceleration rate to prevent an *ov* [*Overvoltage*] fault during motor deceleration. Set  $C1-11$  [*Accel/Decel Time Switchover Freq*] first to automatically set parameters  $C1-02$  [*Deceleration Time 1*] (high speed range) and  $C1-08$  [*Deceleration Time 4*] (low speed range).

### ■ KEB Tuning

KEB Tuning automatically sets parameters used for the KEB Ride-Thru function and for the overvoltage suppression function.

Control Tuning automatically sets the parameters in [Table 3.15](#) to the best values.

Table 3.15 Parameters set in Control Tuning

Parameters Automatically Set	Inertia Tuning	ASR Tuning	Deceleration Rate Tuning	KEB Tuning
C1-02 [Deceleration Time 1]	-	-	x	-
C1-08 [Deceleration Time 4]	-	-	x *1	-
C1-09 [Fast Stop Time]	-	-	-	x *2
C5-01 [ASR Proportional Gain 1]	-	x	-	-
C5-17 [Motor Inertia]	x	x	-	-
C5-37 [Motor 2 Inertia]	x	x	-	-
C5-18 [Load Inertia Ratio]	x	x	-	-
C5-38 [Motor 2 Load Inertia Ratio]	x	x	-	-
L2-06 [Kinetic Energy Backup Decel Time]	-	-	-	x *3
L3-24 [Motor Accel Time @ Rated Torque]	x	x	-	-

Parameters Automatically Set	Inertia Tuning	ASR Tuning	Deceleration Rate Tuning	KEB Tuning
L3-25 [Load Inertia Ratio]	x	x	-	x
n5-02 [Motor Inertia Acceleration Time]	x	x	-	-
n5-03 [Feed Forward Control Gain]	x	x	-	-

- \*1 The drive automatically sets C1-08 [Deceleration Time 4] only when C1-11 [Accel/Decel Time Switchover Freq]  $\neq 0$ .
- \*2 When L2-29 = 0 [Kinetic Energy Backup Method = Single Drive KEB Ride-Thru 1], the drive will automatically adjust C1-09 [Fast Stop Time] and will not adjust L2-06 [Kinetic Energy Backup Decel Time]. If the Fast Stop time must not change, do not do KEB Tuning.
- \*3 When L2-29 = 1, 2, or 3 [Kinetic Energy Backup Method = Single Drive KEB Ride-Thru 2, System KEB Ride-Thru 1, or System KEB Ride-Thru 2], the drive will automatically adjust L2-06 [Kinetic Energy Backup Decel Time].

## ◆ Precautions before Auto-Tuning

Examine the topics in this section before you start Auto-Tuning.

### ■ Prepare for Basic Auto-Tuning

- You must input data from the motor nameplate or motor test report to do Auto-Tuning. Make sure that this data is available before Auto-Tuning the drive.
- For best performance, make sure that the drive input supply voltage is equal to or more than the motor rated voltage.

#### Note:

Better performance is possible when you use a motor with a base voltage that is less than the input supply voltage (20 V for 200 V class models and 40 V for 400 V class models). This is very important when operating the motor at more than 90% of base speed, where high torque precision is necessary. If the input power supply is equal to the motor rated voltage, the drive output voltage will not be sufficient, and performance will decrease.


- Push  on the keypad to cancel Auto-Tuning.
- If a Safe Disable input signal is input to the drive during Auto-Tuning, Auto-Tuning measurements will not complete successfully. If this occurs, cancel the Auto-Tuning, then do it again.
- Table 3.16 gives information about the terminal operations of digital inputs and outputs during Auto-Tuning.

Table 3.16 Status of Input/Output Terminals during Auto-Tuning

Auto-Tuning Type	Mode	Digital Input	Digital Output <sup>*1</sup>	
Induction Motor Auto-Tuning	Rotational	Rotational Auto-Tuning	Disabled	Functions the same as during usual operation.
	Stationary	Stationary Auto-Tuning	Disabled	Keeps the status at the start of Auto-Tuning.
		Stationary Auto-Tuning for Line-to-Line Resistance	Disabled	Keeps the status at the start of Auto-Tuning.
PM Motor Auto-Tuning	Rotational	Z-Pulse Offset Tuning	Disabled	Keeps the status at the start of Auto-Tuning.
		PM Rotational Auto-Tuning	Disabled	Functions the same as during usual operation.
	Stationary	PM Motor Parameter Settings	Disabled	Disabled
		PM Stationary Auto-Tuning	Disabled	Keeps the status at the start of Auto-Tuning.
		PM Stationary Auto-Tuning for Stator Resistance	Disabled	Keeps the status at the start of Auto-Tuning.
EZ Tuning	Stationary	Motor Parameter Setting	Disabled	Disabled
		Stationary Auto-Tuning for Line-to-Line Resistance	Disabled	Keeps the status at the start of Auto-Tuning.

Auto-Tuning Type	Mode		Digital Input	Digital Output <sup>*1</sup>
ASR and Inertia Tuning	Rotational	Inertia Tuning	Disabled	Functions the same as during usual operation.
		ASR Tuning	Disabled	Functions the same as during usual operation.
		Deceleration Rate Tuning	Disabled	Functions the same as during usual operation.
		KEB Tuning	Disabled	Functions the same as during usual operation.

\*1 A terminal to which H2-xx = E [MFDO Function Select = Fault] is assigned functions the same as during usual operation.

**WARNING! Crush Hazard.** Make sure that the holding brake does not open during Stationary Auto-Tuning for Line-to-Line Resistance with the machine connected to the motor. Wire the sequence to prevent a multi-function output terminal to open the holding brake during Auto-Tuning. Failure to obey can cause damage to the machine or personal injury.

**WARNING! Sudden Movement Hazard.** Disconnect the load from the motor for Rotational Auto-Tuning. Failure to obey could cause death or serious injury and cause damage to the machine.

**WARNING! Crush Hazard.** Rotational Auto-Tuning rotates the motor at a frequency that is 50% or more of the rated frequency of the motor. Make sure that there are no issues related to safety in the area around the drive and motor. Failure to obey can cause death or serious injury and damage to machinery.

**NOTICE: Crush Hazard.** When executing Auto-Tuning, voltage is applied to the motor before the motor rotates. Do not touch the motor until Auto-Tuning is completed. Failure to comply may result in injury or death from electrical shock. If PM Rotational Auto-Tuning is performed, the motor will remain stopped for approximately one minute with power applied and then the motor will rotate for one minute.

#### ■ Precautions before Rotational Auto-Tuning

**WARNING! Electrical Shock Hazard.** In Rotational Auto-Tuning, the drive applies voltage to the motor before the motor rotates. Do not touch the motor until Auto-Tuning is complete. Failure to obey could cause serious injury.

- Uncouple the drive from the motor before Rotational Auto-Tuning to prevent drive malfunction. If you do Rotational Auto-Tuning with the motor connected to a load that is more than 30% of the motor duty rating, the drive will not correctly calculate the motor parameters and the motor can operate incorrectly.
- When the load is 30% or less of the motor duty rating, you can do Auto-Tuning with the motor connected to a load.
- Make sure that the motor magnetic brake is released.
- Make sure that external force from the machine will not cause the motor to rotate.

#### ■ Precautions before Stationary Auto-Tuning

- Make sure that the motor magnetic brake is not open.
- Make sure that external force from the machine will not cause the motor to rotate.

**WARNING! Electrical Shock Hazard.** In Stationary Auto-Tuning, the drive applies voltage to the motor. Do not touch the motor until Auto-Tuning is complete. Failure to obey could cause serious injury.

#### Automatically Set E2-02 [Motor Rated Slip] and E2-03 [Motor No-Load Current]

If T1-12 = 1 [Test Mode Selection = Yes] when selecting Stationary Auto-Tuning, the drive will automatically set motor parameters E2-02 [Motor Rated Slip] and E2-03 [Motor No-Load Current] after Auto-Tuning is complete when you use the motor for the first time in Drive Mode.

After Stationary Auto-Tuning is complete, use this procedures to do the operation in test mode:

1. Check the E2-02 and E2-03 values on the “Modified Parameters/Fault Log” screen or the “Parameters” screen.
2. Operate the motor in Drive Mode with these conditions:
  - Do not disconnect the wiring between the motor and drive.
  - Do not lock the motor shaft with a mechanical brake or other device.
  - The maximum motor load must be 30% of the rated load.
  - Keep a constant speed of 30% of E1-06 [Base Frequency] (default value = maximum frequency) or more for 1 second or longer.
3. After the motor stops, check the E2-02 and E2-03 values on the “Modified Parameters/Fault Log” screen or the “Parameters” screen again.
4. Make sure that the input data is correct.  
When the settings in E2-02 and E2-03 are different than in step 1, the drive set the values automatically.



**Note:**

- If you cannot operate the motor with the conditions in step 2 for the first test run and if the values set in *E2-02* and *E2-03* are much different than data in the official test report for the motor and the data listed in *Defaults by Drive Model and Duty Rating ND/HD on page 623*, these problems can occur:
  - Motor vibrations or hunting
  - Not sufficient torque
  - Overcurrent
- In elevator applications, there is a risk of the cage falling and causing personal injury. Do one of these precautions to decrease the risk:
  - After doing Stationary Auto-Tuning, operate the drive as specified by the conditions and procedure above.
  - Set  $T1-12 = 0$  [*Test Mode Selection = No*].
  - Do Rotational Auto-Tuning.
- If you initialize the drive after completing Step 1, do the procedure beginning from Step 1 again.
- For general-purpose motors, the target value for *E2-02* is 1 Hz to 3 Hz, and the target rated current for *E2-03* is 30% to 65%. Larger capacity motors have a lower rated slip, and a smaller ratio for the no-load current rated current. *Defaults by Drive Model and Duty Rating ND/HD on page 623* for details.

### ■ Precautions before Stationary Auto-Tuning for Line-to-Line Resistance and Stator Resistance Auto-Tuning

In V/f control, when the motor cable is 50 meters (164 feet), do Stationary Auto-Tuning for Line-to-Line Resistance.

**WARNING!** *Electrical Shock Hazard. In Stationary Auto-Tuning, the drive applies voltage to the motor. Do not touch the motor until Auto-Tuning is complete. Failure to obey could cause serious injury.*

### ■ Precautions before Inertia Tuning and ASR Tuning

Before Inertia Tuning or ASR Tuning, check these items:

**WARNING!** *Electrical Shock Hazard. In Rotational Auto-Tuning, the drive applies voltage to the motor before the motor rotates. Do not touch the motor until Auto-Tuning is complete. Failure to obey could cause serious injury.*

- Do rotational motor parameter tuning or look at the motor test report or nameplate to enter the values manually.
- Make sure that the motor magnetic brake is released.
- Connect the motor and load.
- Make sure that external force from the machine will not cause the motor to rotate.
- Make sure that the machine does not prevent reverse rotation. You cannot do Inertia Tuning or ASR Tuning with machines that prevent reverse rotation.
- When the motor can rotate during Auto-Tuning, check for safety issues near the drive, motor, and machine.

**Note:**

If there are gears between the machine and motor shaft, Inertia Tuning or ASR Tuning are possibly not applicable.

### ■ Precautions before Using Deceleration Rate Tuning and KEB Tuning

Before Deceleration Rate Tuning or KEB Tuning, check these items:

**Note:**

- Do not do Deceleration Rate Tuning if you use a braking resistor unit or a regenerative converter.
- Do Deceleration Rate Tuning and KEB Tuning with the load attached to the motor.
- Do not do Deceleration Rate Tuning or KEB Tuning for these applications:
  - In Deceleration Rate Tuning and KEB Tuning, the drive will automatically rotate the motor forward and accelerate and decelerate the motor again and again.
    - On a machine that does not let the motor rotate forward
    - In applications with a small range of operation (trolleys and other such applications that can only move linearly)
    - In elevator applications
    - Applications where sudden acceleration and sudden deceleration are not applicable.
- To do KEB Tuning with the external main circuit capacitors connected to the drive, set *L3-26 [Additional DC Bus Capacitors]* then do KEB Tuning.
- Do not do KEB Tuning or Deceleration Rate Tuning if the drive is set to use  $H1-xx = 16$  [*MFDI Function Select = Motor 2 Selection*]. Failure to obey can cause an *ov [Overvoltage]* fault.

## 3.9 Test Run

After you use the Setup Wizard to set the basic parameters and Auto-Tune the drive, the next step is to do a test run.

**WARNING! Crash Hazard.** Test the system to make sure that the drive operates safely after you wire the drive and set parameters. Failure to obey can cause injury or damage to equipment.

### ◆ No-Load Test Run

Before connecting the motor to the machine, make sure that you check the operation status of the motor.

#### ■ Precautions before Operation

Before rotating the motor, check these items:

- Check for safety issues near the drive, motor, and machine.
- Make sure that all emergency stop circuits and machine safety mechanisms are operating correctly.



#### ■ Items to Check before Operation

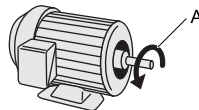
Check these items before operation:

- Is the motor rotating in the forward direction?
- Is the motor rotating smoothly (no unusual sounds or unusual vibrations)?
- Does the motor accelerate/decelerate smoothly?



### ◆ Do a No-Load Test Run

Do these steps for a no-load test run:

1. Energize the drive, or push **F2** to show the HOME screen.  
If [Home] is not shown on **F2**, push **F1** (Back) to show [Home] on **F2**.
2. Push **LO/RE** to illuminate the LOCAL/REMOTE indicator.
3. Push  to show *d1-01 [Reference 1]*, and set it to 6.00 Hz.
4. Push .  
The RUN indicator illuminates, and the motor runs at 6.00 Hz in the forward direction.
5. Make sure that the motor is rotating in the correct direction and that the drive does not show a fault.  
If the drive detects a fault, remove the cause.



**A - Forward Rotation of Motor (Counter Clockwise Direction as Seen from Load Shaft)**


6. Push  to increase the frequency reference value.  
Change the setting value in increments of 10 Hz if necessary and examine the response.
7. Each time you increase the setting value, use *U1-03 [Output Current]* to check the drive output current.  
When the output current of the drive is not more than the motor rated current, the status is correct.  
Ex.: 6 Hz → 20 Hz → 30 Hz → 40 Hz → 50 Hz → 60 Hz
8. Make sure that the motor rotates correctly, then push .  
The RUN indicator will flash. When the motor stops, the indicator will go out.

### ◆ Actual-Load Test Run

Test the operation without a load, then connect the motor and machine to do a test run.

#### ■ Precautions before Operation

Before rotating the motor, check these items:









- Check for safety issues near the drive, motor, and machine.
- Make sure that all emergency stop circuits and machine safety mechanisms are operating correctly.
- Make sure that the motor is fully stopped.
- Connect the motor with the machine.  
Make sure that there are no loose installation screws and that the motor load shafts and machine junctions are correctly secured.
- Keep the keypad near you to push  immediately if there is unusual or incorrect operation.

### ■ Checklist before Operation

- Make sure that the direction of the machine operation is correct (The motor must rotate in the correct direction).
- Make sure that the motor accelerates and decelerates smoothly.

### ◆ Do an Actual-Load Test Run

Connect the motor and machine, then do the test run with the same procedure you used for the no-load test run.

- Make sure that *U1-03 [Output Current]* is not too high.
  1. Energize the drive, or push  (Home) to show the HOME screen.  
If [Home] is not shown on , push  (Back) to show [Home] on .
  2. Set *d1-01 [Reference 1]* to 6.00 Hz.
  3. Push  to illuminate the LOCAL/REMOTE indicator.
  4. Push .  
The RUN indicator illuminates, and the motor runs at 6.00 Hz in the forward direction.
  5. Make sure that the motor is rotating in the correct direction and that the drive does not show a fault.  
If the drive detects a fault, remove the cause.
  6. Push  to increase the frequency reference value.  
Change the setting value in increments of 10 Hz if necessary and examine the response.
  7. Each time you increase the setting value, use *U1-03 [Output Current]* to check the drive output current.  
When the output current of the drive is not more than the motor rated current, the status is correct.  
Ex.: 6 Hz → 20 Hz → 30 Hz → 40 Hz → 50 Hz → 60 Hz
  8. Make sure that the motor rotates correctly, then push .  
The RUN indicator will flash. When the motor stops, the indicator will go out.
  9. Change the frequency reference and direction of motor rotation, and make sure that there are no unusual sounds or vibrations.
  10. If there are hunting or oscillation errors caused by control function, adjust the settings to stop the errors.

## 3.10 Fine Tuning during Test Runs (Adjust the Control Function)

This section gives information about the adjustment procedures to stop hunting or oscillation errors caused by control function during a test run. Adjust the applicable parameters as specified by your control method and drive status.

- [V/f Control and Closed Loop V/f Control on page 204](#)
- [Open Loop Vector Control Method on page 205](#)
- [Closed Loop Vector Control Method on page 208](#)
- [Advanced Open Loop Vector Control Method on page 209](#)
- [Fine-Tuning Open Loop Vector Control for PM Motors on page 211](#)
- [Advanced Open Loop Vector Control Method for PM on page 212](#)
- [Closed Loop Vector Control Method for PM on page 213](#)
- [EZ Open Loop Vector Control Method on page 214](#)

**Note:**

This section only lists frequently adjusted parameters. If you must adjust parameters that have a higher degree of precision, contact Yaskawa.

### ◆ V/f Control and Closed Loop V/f Control

**Table 3.17 Parameters for Fine Tuning the Drive (V/f Control and Closed Loop V/f Control Methods)**

Issue	Parameter Number	Solution	Default Setting	Recommended Setting
Hunting or oscillation at mid-range speeds (10 Hz to 40 Hz)	n1-02 [Hunting Prevention Gain Setting]	<ul style="list-style-type: none"> <li>• If torque is not sufficient with heavy loads, decrease the setting value.</li> <li>• If hunting or oscillation occur with light loads, increase the setting value.</li> <li>• If hunting occurs with a low-inductance motor, for example a motor with a larger frame size or a high-frequency motor, lower the setting value.</li> </ul>	1.00	0.10 - 2.00
<ul style="list-style-type: none"> <li>• The volume of the motor excitation sound is too high.</li> <li>• Hunting or oscillation at low speeds (10 Hz or lower), or at mid-range speeds (10 Hz to 40 Hz)</li> </ul>	C6-02 [Carrier Frequency Selection]	<ul style="list-style-type: none"> <li>• If the volume of the motor excitation sound is too high, increase the carrier frequency.</li> <li>• If hunting or oscillation occur at low or mid-range speeds, decrease the carrier frequency.</li> </ul>	1 (2 kHz) *1	1 to upper limit value
<ul style="list-style-type: none"> <li>• Torque or speed response are slow.</li> <li>• Hunting or oscillation</li> </ul>	C4-02 [Torque Compensation Delay Time]	<ul style="list-style-type: none"> <li>• If torque or speed response are slow, decrease the setting value.</li> <li>• If hunting or oscillation occur, increase the setting value.</li> </ul>	200 ms *2	100 - 1000 ms
<ul style="list-style-type: none"> <li>• Torque at low speeds (10 Hz or lower) is not sufficient.</li> <li>• Hunting or oscillation</li> </ul>	C4-01 [Torque Compensation Gain]	<ul style="list-style-type: none"> <li>• If torque at low speeds (10 Hz or lower) is not sufficient, increase the setting value.</li> <li>• If hunting or oscillation occur with light loads, decrease the setting value.</li> </ul>	1.00	0.50 - 1.50

Issue	Parameter Number	Solution	Default Setting	Recommended Setting
<ul style="list-style-type: none"> <li>Torque at low speeds (10 Hz or lower) is not sufficient.</li> <li>Large initial vibration at start up.</li> </ul>	<ul style="list-style-type: none"> <li>E1-08 [Mid Point A Voltage]</li> <li>E1-10 [Minimum Output Voltage]</li> </ul>	<ul style="list-style-type: none"> <li>If torque at low speeds (10 Hz or lower) is not sufficient, increase the setting value.</li> <li>If there is large initial vibration at start up, decrease the setting value</li> </ul>	<ul style="list-style-type: none"> <li>E1-08: 15.0 V *3</li> <li>E1-10: 9.0 V *3</li> </ul>	Default setting +/- 5 V *4
In V/f control method, speed precision is unsatisfactory.	C3-01 [Slip Compensation Gain]	Set E2-01 [Motor Rated Current], E2-02 [Motor Rated Slip], and E2-03 [Motor No-Load Current], then adjust C3-01.	0.0 (no slip compensation)	0.5 - 1.5
In Closed Loop V/f control method, speed precision is unsatisfactory.	<ul style="list-style-type: none"> <li>C5-01 [ASR Proportional Gain 1 (P)]</li> <li>C5-02 [ASR Integral Time 1 (I)] *5</li> </ul>	Adjust C5-01, C5-02.	<ul style="list-style-type: none"> <li>C5-01: 0.20</li> <li>C5-02: 0.200 s</li> </ul>	<ul style="list-style-type: none"> <li>Proportional gain = 0.10 to 1.00</li> <li>Integral time = 0.100 to 2.000 s</li> </ul>

- \*1 Default value changes when o2-04 [Drive Model (KVA) Selection] and C6-01 [Normal / Heavy Duty Selection] values change.
- \*2 Default value changes when A1-02 [Control Method Selection] and o2-04 [Drive Model (KVA) Selection] values change.
- \*3 Default value changes when A1-02 [Control Method Selection] and E1-03 [V/f Pattern Selection] values change.
- \*4 Recommended settings are for 200 V class drives. Multiply the voltage by 2 for 400 V class drives.
- \*5 In Closed Loop V/f Control, ASR only controls the output frequency. You cannot make a high-gain as in Closed Loop Vector control.

### ◆ Open Loop Vector Control Method

In Open Loop Vector Control, keep C4-01 [Torque Compensation Gain] at its default setting (1.00). Do not adjust it.

If you cannot get speed precision during regeneration in Open Loop Vector Control, set C3-04 = 1 [Slip Compensation @ Regen Select = Enabled Above 6Hz].

### 3.10 Fine Tuning during Test Runs (Adjust the Control Function)

**Table 3.18 Parameters for Fine Tuning the Drive (Open Loop Vector Control Method)**

Issue	Parameter Number	Solution	Default Setting	Recommended Setting
<ul style="list-style-type: none"> <li>• Torque or speed response are slow.</li> <li>• Hunting or oscillation at mid-range speeds (10 Hz to 40 Hz)</li> </ul>	n2-01 [SpdFeedbackDetectCtr (AFR) Gain]	<ul style="list-style-type: none"> <li>• To increase the speed of torque or speed response, decrease the setting value in increments of 0.05.</li> <li>• If hunting or oscillation occur, decrease the setting value in increments of 0.05.</li> </ul>	1.00	0.50 - 2.00
	n2-02 [SpdFeedbackDetCtr (AFR)TimeConst1]	<ul style="list-style-type: none"> <li>• To increase the speed of torque or speed response, decrease the setting value in increments of 10 ms and examine the response.</li> <li>• If hunting or oscillation occur or if the load inertia is too much, increase the setting value in increments of 50 ms and examine the response.</li> </ul> <p><b>Note:</b> Make sure that this parameter setting is: <math>n2-02 \leq n2-03</math> [SpdFeedbackDetCtr (AFR)TimeConst2] holds true.</p> <p>When you adjust <i>n2-02</i>, you must also increase the <i>C4-02</i> [Torque Compensation Delay Time] value by the same ratio.</p>	50 ms	50 - 2000 ms

### 3.10 Fine Tuning during Test Runs (Adjust the Control Function)

Issue	Parameter Number	Solution	Default Setting	Recommended Setting
<p><i>ov</i> [overvoltage] occurs when the drive stops accelerating, starts to decelerate, or when there are large changes in the load.</p>	<p>n2-03 [SpdFeedbackDetCtr (AFR)TimeConst2]</p>	<ul style="list-style-type: none"> <li>If <i>ov</i> occurs, increase the setting value in increments of 50 ms and examine the response.</li> <li>If the response is not sufficient, decrease the setting value in increments of 10 ms and examine the response.</li> </ul> <p><b>Note:</b> Make sure that this parameter setting is: <i>n2-02</i> [SpdFeedbackDetCtr (AFR)TimeConst1] ≤ <i>n2-03</i>. When you adjust <i>n2-03</i> you must also increase the <i>C4-06</i> [Motor 2 Torque Comp Delay Time] value by the same ratio.</p>	750 ms	750 - 2000 ms
	<p>C4-06 [Motor 2 Torque Comp Delay Time]</p>	<ul style="list-style-type: none"> <li>If <i>ov</i> occurs, increase the setting value in increments of 10 ms and examine the response.</li> <li>If the response is not sufficient, decrease the setting value in increments of 2 ms and examine the response.</li> </ul> <p><b>Note:</b> Make sure that this parameter setting is: <i>C4-02</i> [Torque Compensation Delay Time] ≤ <i>C4-06</i>. When you adjust <i>C4-06</i>, you must also increase then <i>n2-03</i> [SpdFeedbackDetCtr (AFR)TimeConst2] value by the same ratio.</p>	150 ms	150 - 750 ms
<ul style="list-style-type: none"> <li>Torque or speed response are slow.</li> <li>Hunting or oscillation</li> </ul>	<p>C4-02 [Torque Compensation Delay Time]</p>	<ul style="list-style-type: none"> <li>If torque or speed response are slow, decrease the setting value in increments of 2 ms.</li> <li>If hunting or oscillation occur, increase the setting value in increments of 10 ms.</li> </ul> <p><b>Note:</b> Make sure that this parameter setting is: <i>C4-02</i> ≤ <i>C4-06</i> [Motor 2 Torque Comp Delay Time]. When you adjust <i>C4-02</i>, you must also increase the <i>n2-02</i> [SpdFeedbackDetCtr (AFR)TimeConst1] value by the same ratio.</p>	20 ms *I	20 - 100 ms *I

### 3.10 Fine Tuning during Test Runs (Adjust the Control Function)

Issue	Parameter Number	Solution	Default Setting	Recommended Setting
<ul style="list-style-type: none"> <li>Speed response is slow.</li> <li>Speed is not stable.</li> </ul>	C3-02 [Slip Compensation Delay Time]	<ul style="list-style-type: none"> <li>If speed response is slow, decrease the setting value in increments of 10 ms.</li> <li>If speed is not stable, increase the value in increments of 10 ms.</li> </ul>	200 ms <sup>*1</sup>	100 - 500 ms
Speed precision is unsatisfactory.	C3-01 [Slip Compensation Gain]	<ul style="list-style-type: none"> <li>If speed is too slow, increase the setting value in increments of 0.1.</li> <li>If speed is too fast, decrease the setting value in increments of 0.1.</li> </ul>	1.0 <sup>*2</sup>	0.5 - 1.5
<ul style="list-style-type: none"> <li>The volume of the motor excitation sound is too high.</li> <li>Hunting or oscillation at low speeds (10 Hz or lower)</li> </ul>	C6-02 [Carrier Frequency Selection]	<ul style="list-style-type: none"> <li>If the volume of the motor excitation sound is too high, increase the carrier frequency.</li> <li>If hunting or oscillation occur at low speeds, decrease the carrier frequency.</li> </ul>	1 (2 kHz) <sup>*3</sup>	0 to upper limit value
<ul style="list-style-type: none"> <li>Torque at low speeds (10 Hz or lower) is not sufficient. speed response is slow.</li> <li>Speed response is slow.</li> <li>Large initial vibration at start up.</li> </ul>	<ul style="list-style-type: none"> <li>E1-08 [Mid Point A Voltage]</li> <li>E1-10 [Minimum Output Voltage]</li> </ul>	<ul style="list-style-type: none"> <li>If torque or speed response are slow, increase the setting value.</li> <li>If there is large initial vibration at start up, decrease the setting value</li> </ul> <p><b>Note:</b> If the setting value is set too high, a large torque reference may be output even with light loads.</p>	<ul style="list-style-type: none"> <li>E1-08: 11.0 <sup>*2</sup></li> <li>E1-10: 2.0 <sup>*2</sup></li> </ul>	Default setting +/- 2 V <sup>*4</sup>

\*1 Default value changes when A1-02 [Control Method Selection] and o2-04 [Drive Model (KVA) Selection] values change.

\*2 Default value changes when A1-02 [Control Method Selection] and E1-03 [V/f Pattern Selection] values change.

\*3 Default value changes when o2-04 [Drive Model (KVA) Selection] and C6-01 [Normal / Heavy Duty Selection] values change.

\*4 Recommended settings are for 200 V class drives. Multiply the voltage by 2 for 400 V class drives.

## ◆ Closed Loop Vector Control Method

Table 3.19 Parameters for Fine Tuning the Drive (Closed Loop Vector Control Method)

Issue	Parameter Number	Solution	Default Setting	Recommended Setting
<ul style="list-style-type: none"> <li>Torque or speed response are slow.</li> <li>Hunting or oscillation</li> </ul>	<ul style="list-style-type: none"> <li>High speed C5-01 [ASR Proportional Gain 1 (P)]</li> <li>Low speed C5-03 [ASR Proportional Gain 2 (P)] <sup>*1</sup></li> </ul>	<ul style="list-style-type: none"> <li>If torque or speed response are slow, increase the setting value in increments of 5.00.</li> <li>If hunting or oscillation occur, decrease the setting value.</li> </ul>	20.00	10.00 - 50.00
	<ul style="list-style-type: none"> <li>High speed C5-02 [ASR Integral Time 1 (I)]</li> <li>Low speed C5-04 [ASR Integral Time 2 (I)] <sup>*1</sup></li> </ul>	<ul style="list-style-type: none"> <li>If torque or speed response are slow, decrease the setting value.</li> <li>If hunting or oscillation occur, increase the setting value.</li> </ul>	0.500 s	0.300 to 1.000 s
The drive cannot find ASR proportional gain or integral time for low speed or high speed.	C5-07 [ASR Gain Switchover Frequency] <sup>*1</sup>	Change the ASR proportional gain and ASR integral time to conform to the output frequency.	0.0 Hz	0.0 Hz to maximum output frequency



Issue	Parameter Number	Solution	Default Setting	Recommended Setting
Hunting or oscillation	C5-06 [ASR Delay Time] <i>*1</i>	<ul style="list-style-type: none"> <li>If torque or speed response are slow, decrease the setting value in increments of 0.010.</li> <li>If the rigidity of the machine is unsatisfactory and vibration is possible, increase the setting value.</li> </ul>	0.004 s	0.004 to 0.020 s
<ul style="list-style-type: none"> <li>The volume of the motor excitation sound is too high.</li> <li>Hunting or oscillation at low speeds (3 Hz or lower)</li> </ul>	C6-02 [Carrier Frequency Selection]	<ul style="list-style-type: none"> <li>If the volume of the motor excitation sound is too high, increase the carrier frequency.</li> <li>If hunting or oscillation occur at low speeds, decrease the carrier frequency.</li> </ul>	1 (2.0 kHz) <i>*2</i>	2.0 kHz to upper limit value

\*1 Refer to the section on C5-xx parameters for more information about speed control (ASR).

\*2 Default value changes when *o2-04 [Drive Model (KVA) Selection]* and *C6-01 [Normal / Heavy Duty Selection]* values change.

### ◆ Advanced Open Loop Vector Control Method

Table 3.20 Parameters for Fine Tuning the Drive (Advanced Open Loop Vector Control Method)

Issue	Parameter Number	Solution	Default Setting	Recommended Setting
<ul style="list-style-type: none"> <li><i>oS [Overspeed]</i> occurs.</li> <li>Hunting or oscillation.</li> </ul>	T1-01 [Auto-Tuning Mode Selection]	<ul style="list-style-type: none"> <li>Make sure that the output of the drive and the motor are connected correctly.</li> <li>Decouple the motor and machine and do Rotational Auto-Tuning.</li> </ul>	-	0
The volume of the motor excitation sound is too high.	C6-02 [Carrier Frequency Selection]	If the volume of the motor excitation sound is too high, increase the carrier frequency.	1 (2 kHz) <i>*1</i>	1 to upper limit value
Speed precision is unsatisfactory	E2-02 [Motor Rated Slip]	<ul style="list-style-type: none"> <li>Decouple the motor and machine and do Rotational Auto-Tuning.</li> <li>If the motor speed is slow, increase the value of <i>E2-02</i> in small increments (approximately 0.1% of the default setting value).</li> <li>If the motor speed is fast, decrease the value of <i>E2-02</i> in small increments (approximately 0.1% of the default setting value).</li> </ul>	<i>*2</i>	Set to a value that is $\pm 5\%$ of the current value.

### 3.10 Fine Tuning during Test Runs (Adjust the Control Function)

Issue	Parameter Number	Solution	Default Setting	Recommended Setting
<ul style="list-style-type: none"> <li>Torque or speed response are slow.</li> <li>Hunting or oscillation</li> </ul>	<ul style="list-style-type: none"> <li>High speed C5-01 [ASR Proportional Gain 1 (P)]</li> <li>Low speed C5-03 [ASR Proportional Gain 2 (P)] *3</li> </ul>	<ul style="list-style-type: none"> <li>If torque or speed response are slow, increase the setting value in increments of 5.00.</li> <li>If hunting or oscillation occur, decrease the setting value.</li> </ul>	20.00	10.00 - 50.00
	<ul style="list-style-type: none"> <li>High speed C5-02 [ASR Integral Time 1 (I)]</li> <li>Low speed C5-04 [ASR Proportional Gain 2 (P)] *3</li> </ul>	<ul style="list-style-type: none"> <li>If torque or speed response are slow, decrease the setting value.</li> <li>If hunting or oscillation occur, increase the setting value.</li> </ul>	0.500 s	0.300 to 1.000 s
The drive cannot find speed response for low speed or high speed.	<ul style="list-style-type: none"> <li>C5-07 [ASR Gain Switchover Frequency] *4</li> <li>High speed C5-01 [ASR Proportional Gain 1 (P)]</li> <li>C5-02 [ASR Integral Time 1 (I)]</li> <li>Low speed C5-03 [ASR Proportional Gain 2 (P)] *3</li> <li>C5-04 [ASR Integral Time 2 (I)]</li> </ul>	Change the ASR proportional gain and ASR integral time to conform to the output frequency.	0.0 Hz	0.0 to maximum output frequency
Hunting or oscillation	C5-06 [ASR Delay Time] *4	<ul style="list-style-type: none"> <li>If torque or speed response are slow, decrease the setting value in increments of 0.010.</li> <li>If the rigidity of the machine is unsatisfactory and vibration is possible, increase the setting value.</li> </ul>	0.004 s	0.004 to 0.020 s

\*1 Default value changes when o2-04 [Drive Model (KVA) Selection] and C6-01 [Normal / Heavy Duty Selection] values change.

\*2 Default value changes when o2-04 [Drive Model (KVA) Selection] value changes.

\*3 Refer to the section on C5-xx parameters for more information about speed control (ASR).

\*4 The best values for a no-load operation are different than the best values for actual loading operation.

## ◆ Fine-Tuning Open Loop Vector Control for PM Motors

Table 3.21 Parameters for Fine-Tuning Performance in OLV/PM

Issue	Parameter Number	Solution	Default Setting	Recommended Setting
Unsatisfactory motor performance	E1 parameters, E5 parameters	<ul style="list-style-type: none"> <li>Check the settings for <i>E1-06, E1-04 [Base Frequency, Maximum Output Frequency]</i>.</li> <li>Check the <i>E5-xx</i> and make sure that all motor data has been set correctly.</li> </ul> <p><b>Note:</b> Do not set <i>E5-05 [PM Motor Resistance (ohms/phase)]</i> to a line-to-line resistance value.</p> <ul style="list-style-type: none"> <li>Do Auto-Tuning.</li> </ul>	-	-
Unsatisfactory motor torque and speed response	n8-55 [Motor to Load Inertia Ratio]	Adjust to match the load inertia ratio of the motor and machine.	0	Near the actual load inertia ratio.
	n8-45 [Speed Feedback Detection Gain]	Decrease the setting value in increments of 0.05.	0.80	-
	C4-01 [Torque Compensation Gain]	Adjust the setting value. <b>Note:</b> Setting this value too high can cause overcompensation and motor oscillation.	0.00	1.00
<ul style="list-style-type: none"> <li>Oscillation at start.</li> <li>Motor stalls.</li> </ul>	n8-51 [Pull-in Current @ Accel/Decel]	Increase the setting value in increments of 5%.	50%	-
	<ul style="list-style-type: none"> <li>b2-02 [DC Injection Braking Current]</li> <li>b2-03 [DC Inject Braking Time at Start]</li> </ul>	Use DC Injection Braking at start. <b>Note:</b> This can cause the motor to rotate in reverse for approximately 1/8 of a turn at start.	<ul style="list-style-type: none"> <li>b2-02: 50%</li> <li>b2-03: 0.0 s</li> </ul>	<ul style="list-style-type: none"> <li>b2-02: Adjust as necessary.</li> <li>b2-03: 0.5 s</li> </ul>
	n8-55 [Motor to Load Inertia Ratio]	Increase the setting value. <b>Note:</b> When operating a single motor or with a minimum amount of inertia, setting this value too high can cause motor oscillation.	0	Near to the actual load inertia ratio.
There is too much current during deceleration.	n8-79 [Pull-in Current at Deceleration]	Set $n8-79 < n8-51$ .	0% <b>Note:</b> When $n8-79 = 0$ , the drive will apply the $n8-51$ setting to the pull-in current during deceleration.	Decrease in increments of 5%.

### 3.10 Fine Tuning during Test Runs (Adjust the Control Function)

Issue	Parameter Number	Solution	Default Setting	Recommended Setting
Stalling or oscillation occurs when load is applied during constant speed	n8-47 [Pull-in Current Comp Filter Time]	Decrease the setting value in increments of 0.2 s.	5.0 s	-
	n8-48 [Pull-in/Light Load Id Current]	Increase the setting value in increments of 5%.	30%	-
	n8-55 [Motor to Load Inertia Ratio]	Increase the setting value. <b>Note:</b> When operating a single motor or with a minimum amount of inertia, setting this value too high can cause motor oscillation.	0	Near to the actual load inertia ratio.
Hunting or oscillation	n8-45 [Speed Feedback Detection Gain]	Increase the setting value in increments of 0.05.	0.80	-
The drive detects <i>STPo</i> [Motor Step-Out Detected] fault when the load is not too high.	<ul style="list-style-type: none"> <li>E5-09 [PM Back-EMF Vpeak (mV/(rad/s))]</li> <li>E5-24 [PM Back-EMF L-L Vrms (mV/rpm)]</li> </ul>	<ul style="list-style-type: none"> <li>Adjust the setting value.</li> <li>Examine the motor code on the motor nameplate or the data sheet, then set correct values for E5-09 or E5-24.</li> </ul>	*1	<ul style="list-style-type: none"> <li>Yaskawa motor Set the motor code from the motor nameplate.</li> <li>Motor from another manufacturer Set the values from the test report.</li> </ul>
The drive detected stalling or <i>STPo</i> [Motor Step-Out Detected] at high speed and maximum output voltage.	n8-62 [Output Voltage Limit Level]	Set to a value lower than the actual input voltage.	<ul style="list-style-type: none"> <li>200.0 V</li> <li>400.0 V</li> </ul>	-

\*1 Default value changes when E5-01 [Motor Code Selection] and o2-04 [Drive Model (KVA) Selection] values change.

### ◆ Advanced Open Loop Vector Control Method for PM

Table 3.22 Parameters for Fine Tuning the Drive (Advanced Open Loop Vector Control Method for PM)

Issue	Parameter Number	Solution	Default Setting	Recommended Setting
<ul style="list-style-type: none"> <li>Torque or speed response are slow.</li> <li>Hunting or oscillation</li> </ul>	<ul style="list-style-type: none"> <li>High speed C5-01 [ASR Proportional Gain 1 (P)]</li> <li>Low speed C5-03 [ASR Proportional Gain 2 (P)]</li> </ul>	<ul style="list-style-type: none"> <li>If torque or speed response are slow, increase the setting value in increments of 5.00.</li> <li>If hunting or oscillation occur, decrease the setting value.</li> </ul>	10.00	5.00 - 30.00 *1
	<ul style="list-style-type: none"> <li>High speed C5-02 [ASR Integral Time 1 (I)]</li> <li>Low speed C5-04 [ASR Integral Time 2 (I)]</li> </ul>	<ul style="list-style-type: none"> <li>If torque or speed response are slow, decrease the setting value.</li> <li>If hunting or oscillation occur, increase the setting value.</li> </ul>	0.500 s	0.300 to 1.000 s *1
The drive cannot find ASR proportional gain or integral time for low speed or high speed.	C5-07 [ASR Gain Switchover Frequency]	Change the ASR proportional gain and ASR integral time to conform to the output frequency.	0.0 %	0.0% to maximum rotation speed
Hunting or oscillation	C5-06 [ASR Delay Time]	If the rigidity of the machine is unsatisfactory and vibration is possible, increase the setting value in increments of 0.010.	0.016 s	0.016 to 0.035 s *1
Step-out	E1-xx parameters, E5-xx parameters	Refer to the motor nameplate or test report and set E1-xx or E5-xx correctly.	-	-

\*1 The best values for a no-load operation are different than the best values for actual loading operation.

◆ Closed Loop Vector Control Method for PM

Table 3.23 Parameters for Fine Tuning the Drive (Closed Loop Vector Control Method for PM)

Issue	Parameter Number	Solution	Default Setting	Recommended Setting
<ul style="list-style-type: none"> <li>Torque or speed response are slow.</li> <li>Hunting or oscillation</li> </ul>	<ul style="list-style-type: none"> <li>High speed C5-01 [ASR Proportional Gain 1 (P)]</li> <li>Low speed C5-03 [ASR Proportional Gain 2 (P)]</li> </ul>	<ul style="list-style-type: none"> <li>If torque or speed response are slow, increase the setting value in increments of 5.00.</li> <li>If hunting or oscillation occur, decrease the setting value.</li> </ul>	20.00	10.00 - 50.00 <sup>*1</sup>
	<ul style="list-style-type: none"> <li>High speed C5-02 [ASR Integral Time 1 (I)]</li> <li>Low speed C5-04 [ASR Integral Time 2 (I)]</li> </ul>	<ul style="list-style-type: none"> <li>If torque or speed response are slow, decrease the setting value.</li> <li>If hunting or oscillation occur, increase the setting value.</li> </ul>	0.500 s	0.300 to 1.000 s <sup>*1</sup>
The drive cannot find speed response for low speed or high speed.	<ul style="list-style-type: none"> <li>C5-07 [ASR Gain Switchover Frequency]</li> <li>High speed C5-01 [ASR Proportional Gain 1 (P)]</li> <li>C5-02 [ASR Integral Time 1 (I)]</li> <li>Low speed C5-03 [ASR Proportional Gain 2 (P)]</li> <li>C5-04 [ASR Integral Time 2 (I)]</li> </ul>	Change the ASR proportional gain and ASR integral time to conform to the output frequency.	0.0 %	0.0% to maximum rotation speed
Hunting or oscillation	C5-06 [ASR Delay Time]	If the rigidity of the machine is unsatisfactory and vibration is possible, increase the setting value in increments of 0.010.	0.004 s	0.004 to 0.020 s <sup>*1</sup>
Step-out	E1-xx parameters, E5-xx parameters	Refer to the motor nameplate or test report and set E1-xx or E5-xx correctly.	-	-

\*1 The best values for a no-load operation are different than the best values for actual loading operation.

◆ EZ Open Loop Vector Control Method

Table 3.24 Parameters for Fine Tuning the Drive (EZ Open Loop Vector Control Method)

Issue	Parameter Number	Solution	Default Setting	Recommended Setting
<ul style="list-style-type: none"> <li>Torque or speed response are slow.</li> <li>Hunting or oscillation</li> </ul>	<ul style="list-style-type: none"> <li>High speed C5-01 [ASR Proportional Gain 1 (P)]</li> <li>Low speed C5-03 [ASR Proportional Gain 2 (P)]</li> </ul>	<ul style="list-style-type: none"> <li>If torque or speed response are slow, increase the setting value in increments of 5.00.</li> <li>If hunting or oscillation occur, decrease the setting value.</li> </ul>	10.00	10.00 - 50.00 <sup>*1</sup>
	<ul style="list-style-type: none"> <li>High speed C5-02 [ASR Integral Time 1 (I)]</li> <li>Low speed C5-04 [ASR Integral Time 2 (I)]</li> </ul>	<ul style="list-style-type: none"> <li>If torque or speed response are slow, decrease the setting value.</li> <li>If hunting or oscillation occur, increase the setting value.</li> </ul>	0.500 s	0.300 to 1.000 s <sup>*1</sup>
The drive cannot find ASR proportional gain or integral time for low speed or high speed.	C5-07 [ASR Gain Switchover Frequency]	Change the ASR proportional gain and ASR integral time to conform to the output frequency.	0.0%	0.0% to maximum rotation speed
Hunting or oscillation	C5-06 [ASR Delay Time]	If the rigidity of the machine is unsatisfactory and vibration is possible, increase the setting value in increments of 0.010.	0.004 s	0.004 to 0.020 s <sup>*1</sup>
Step-out	E9-xx parameters	Refer to the motor nameplate or test report and set E9-xx correctly.	-	-
Oscillation when the motor starts.	n8-51 [Pull-in Current @ Acceleration]	Increase the setting value.	80%	Increase in increments of 5%.
Motor stalls.	L7-01 to L7-04 [Torque Limit]	Increase the setting value.	200%	Increase in increments of 10%.

\*1 The best values for a no-load operation are different than the best values for actual loading operation.

## 3.11 Test Run Checklist

Examine the items in this checklist and check each item before a test run.

Check	No.	Description
	1	Correctly install and wire the drive as specified by this manual.
	2	Energize the drive.
	3	Set the voltage for the power supply in <i>E1-01 [Input AC Supply Voltage]</i> .

Check the applicable items as specified by your control method.

**WARNING! Sudden Movement Hazard.** Correctly wire the start/stop and safety circuits before energizing the drive. Momentarily closing a digital input terminal can start a drive that is programmed for 3-Wire control. Failure to obey can cause death or serious injury from moving equipment.

**Table 3.25 V/f Control [A1-02 = 0] and Closed Loop V/f Control [A1-02 = 1]**

Check	No.	Description
	4	Select the best V/f pattern for your application and motor characteristics. Example: For a motor with a rated frequency of 60 Hz, set <i>E1-03 = 1 [V/f Pattern Selection = Const Trq, 60Hz base, 60Hz max]</i> as a standard V/f pattern.

**Table 3.26 Closed Loop V/f Control [A1-02 = 1]**

Check	No.	Description
	5	Set <i>F1-01 [Encoder 1 Pulse Count (PPR)]</i> correctly and make sure that encoder pulse counting direction is correct.
	6	Set <i>C5-01 [ASR Proportional Gain 1]</i> and <i>C5-02 [ASR Integral Time 1]</i> .

**Table 3.27 Open Loop Vector Control [A1-02 = 2] or Closed Loop Vector Control [A1-02 = 3]**

Check	No.	Description
	7	Decouple motor shafts and machines.
	8	Refer to the information on the motor nameplate and set this data correctly: <ul style="list-style-type: none"> <li>• Motor rated power (kW) to <i>T1-02</i></li> <li>• Motor rated voltage (V) to <i>T1-03</i></li> <li>• Motor rated current (A) to <i>T1-04</i></li> <li>• Motor base frequency (Hz) to <i>T1-05</i></li> <li>• Number of motor poles to <i>T1-06</i></li> <li>• Motor base speed (min<sup>-1</sup>) to <i>T1-07</i></li> </ul>
	9	Do Rotational Auto-Tuning.

**Table 3.28 Closed Loop Vector Control [A1-02 = 3]**

Check	No.	Description
	10	Set <i>F1-01 [Encoder 1 Pulse Count (PPR)]</i> and <i>F1-05 [Encoder 1 Rotation Selection]</i> .
	11	Set <i>C5-01 [ASR Proportional Gain 1]</i> and <i>C5-02 [ASR Integral Time 1]</i> .

**Table 3.29 PM Open Loop Vector Control [A1-02 = 5]**

Check	No.	Description
	12	Set <i>E5-01 through E5-24 [PM Motor Settings]</i> .

**Table 3.30 PM Advanced Open Loop Vector [A1-02 = 6]**

Check	No.	Description
	13	Set <i>E5-01 through E5-24 [PM Motor Settings]</i> .
	14	Set <i>C5-01 [ASR Proportional Gain 1]</i> and <i>C5-02 [ASR Integral Time 1]</i> .

**Table 3.31 PM Closed Loop Vector Control [A1-02 = 7]**

Check	No.	Description
	15	Set <i>E5-01 through E5-24 [PM Motor Settings]</i> .
	16	Set <i>C5-01 [ASR Proportional Gain 1]</i> and <i>C5-02 [ASR Integral Time 1]</i> .

### 3.11 Test Run Checklist

Check	No.	Description
	17	Set F1-01 [Encoder 1 Pulse Count (PPR)] and F1-05 [Encoder 1 Rotation Selection].
	18	Set E5-11 [Encoder Z-Pulse Offset].

Check	No.	Description
	19	The keypad will show "Rdy" after starting to operate the motor.
	20	To give the Run command and frequency reference from the keypad, push <b>LO/RE</b> to set to LOCAL Mode (when in LOCAL Mode, the LO/RE LED illuminates).
	21	If the motor rotates in the opposite direction during test run, switch two of the motor cables (U/T1, V/T2, W/T3).
	22	Set Heavy Duty or Normal Duty Mode with C6-01 [Normal / Heavy Duty Selection] to conform to the load condition.
	23	Set E2-01 [Motor Rated Current (FLA)] and L1-01 [Motor Overload Protection Select] correctly for motor thermal protection.
	24	Set the drive for REMOTE Mode when the control circuit terminals supply the Run command and frequency reference (in REMOTE Mode, the LO/RE LED turns OFF).
	25	<p>When terminal A1 is used for the frequency reference:</p> <ul style="list-style-type: none"> <li>• Voltage input <ul style="list-style-type: none"> <li>– Set DIP Switch S1-1 on the drive to "V".</li> <li>– Set H3-01 = 0, 1 [Terminal A1 Signal Level Select = 0 to 10V (Lower Limit at 0), -10 to +10V (Bipolar Reference)].</li> <li>– Set H3-02 = 0 [Terminal A1 Function Selection = Frequency Reference].</li> </ul> </li> <li>• Current input <ul style="list-style-type: none"> <li>– Set DIP Switch S1-1 on the drive to "I".</li> <li>– Set H3-01 = 2, 3 [Terminal A1 Signal Level Select = 4 to 20 mA, 0 to 20 mA].</li> <li>– Set H3-02 = 0 [Terminal A1 Function Selection = Frequency Reference].</li> </ul> </li> </ul>
	26	<p>When terminal A2 is used for the frequency reference:</p> <ul style="list-style-type: none"> <li>• Voltage input <ul style="list-style-type: none"> <li>– Set DIP Switch S1-2 on the drive to "V".</li> <li>– Set H3-09 = 0, 1 [Terminal A2 Signal Level Select = 0 to 10V (Lower Limit at 0), -10 to +10V (Bipolar Reference)].</li> <li>– Set H3-10 = 0 [Terminal A2 Function Selection = Frequency Reference].</li> </ul> </li> <li>• Current input <ul style="list-style-type: none"> <li>– Set DIP Switch S1-2 on the drive to "I".</li> <li>– Set H3-09 = 2, 3 [Terminal A2 Signal Level Select = 4 to 20 mA, 0 to 20 mA].</li> <li>– Set H3-10 = 0 [Terminal A2 Function Selection = Frequency Reference].</li> </ul> </li> </ul>



Check	No.	Description
	27	<p>When terminal A3 is used for the frequency reference:</p> <ul style="list-style-type: none"> <li>• Voltage input <ul style="list-style-type: none"> <li>– Set DIP Switch S4 on the drive to analog input side.</li> <li>– Set DIP Switch S1-3 on the drive to “V”.</li> <li>– Set H3-05 = 0, 1 [Terminal A3 Signal Level Select = 0 to 10V (Lower Limit at 0), -10 to +10V (Bipolar Reference)].</li> <li>– Set H3-06 = 0 [Terminal A3 Function Selection = Frequency Reference].</li> </ul> </li> <li>• Current input <ul style="list-style-type: none"> <li>– Set DIP Switch S4 on the drive to analog input side.</li> <li>– Set DIP Switch S1-3 on the drive to “I”.</li> <li>– Set H3-05 = 2, 3 [Terminal A3 Signal Level Select = 4 to 20 mA, 0 to 20 mA].</li> <li>– Set H3-06 = 0 [Terminal A3 Function Selection = Frequency Reference].</li> </ul> </li> </ul>
	28	<p>Make sure that the frequency reference reaches the necessary minimum and maximum values.</p> <p>If drive operation is incorrect, make these adjustments:</p> <p>Gain adjustment: Set the maximum voltage and current values, then adjust the analog input gain until the frequency reference reaches the necessary value. (For terminal A1 input: H3-03, for terminal A2 input: H3-11, for terminal A3 input: H3-07)</p> <p>Bias adjustment: Set the maximum voltage/current values, then adjust the analog input bias until the frequency reference reaches the necessary minimum value. (For terminal A1 input: H3-04, for terminal A2 input: H3-12, for terminal A3 input: H3-08)</p>



# Standards Compliance

---

This chapter gives information about how to make the machines and devices that use this product comply with European standards and UL standards.

<b>4.1</b>	<b>General Safety</b> .....	<b>220</b>
<b>4.2</b>	<b>European Standards</b> .....	<b>222</b>
<b>4.3</b>	<b>UL Standards</b> .....	<b>256</b>
<b>4.4</b>	<b>China RoHS Compliance</b> .....	<b>282</b>
<b>4.5</b>	<b>对应中国RoHS指令</b> .....	<b>283</b>
<b>4.6</b>	<b>Safe Disable Input</b> .....	<b>284</b>

## 4.1 General Safety

### DANGER

#### Electrical Shock Hazard

**Do not examine, connect, or disconnect wiring on an energized drive. Before servicing, disconnect all power to the equipment and wait for the time specified on the warning label at a minimum. The internal capacitor stays charged after the drive is de-energized. The charge indicator LED extinguishes when the DC bus voltage decreases below 50 Vdc. When all indicators are OFF, remove the covers before measuring for dangerous voltages to make sure that the drive is safe.**

Failure to obey will cause death or serious injury.

### WARNING

#### Electrical Shock Hazard

**Do not operate equipment when covers are missing. Some figures in this section include drives without covers or safety shields to more clearly show the inside of the drive. Replace covers and shields before operation. Use drives only as specified by the instructions.**

Failure to obey can cause death or serious injury.

**Always ground the motor-side grounding terminal.**

Contacting the motor case can cause death or serious injury from incorrect equipment grounding.

**Do not remove covers or touch circuit boards while the drive is energized.**

Failure to obey can cause death or serious injury.

**Do not touch components while energized. Do not touch the output terminals directly with your hands. Also ensure that the output wiring do not come into contact with the drive case.**

Failure to obey could cause death or serious injury.

**Only let authorized persons install, wire, maintain, examine, replace parts, and repair the drive.**

Failure to obey can cause death or serious injury.

**Do not work on the drive or around the drive while wearing loose clothing or jewelry. Tighten loose clothing and remove all metal objects such as watches or rings.**

Failure to obey can cause death or serious injury.

**Do not make changes to the drive body or drive circuitry.**

Failure to obey can cause death or serious injury and will void warranty. Yaskawa is not responsible for changes to the product made by the user.

#### Fire Hazard

**Tighten all terminal screws to the correct tightening torque.**

Connections that are too loose or too tight can cause incorrect operation and damage to the drive. Incorrect connections can also cause death or serious injury from fire.

**Tighten screws against the bit at an angle in the specified range shown in this manual.**

If you tighten the screws at an angle not in the specified range, you can have loose connections that can cause damage to the terminal block or start a fire.

**Do not use the main circuit power supply (Overcurrent Category III) at incorrect voltages. Make sure that the drive rated voltage aligns with the power supply voltage before energizing the drive.**

Failure to obey can cause death or serious injury.

**Do not put flammable or combustible materials on top of the drive and do not install the drive near flammable or combustible materials. Attach the drive to metal or other noncombustible material.**

Failure to obey can cause death or serious injury.

**⚠ WARNING****Sudden Movement Hazard**

**Do not do work on the drive without eye protection. Wear eye protection before you start work on the drive.**

Failure to obey could cause serious injury or death.

**Electrical Shock Hazard**

**Do not immediately energize the drive or operate peripheral devices after the drive blows a fuse or trips an RCM/RCD. Wait for the time specified on the warning label at a minimum and make sure that all indicators are OFF. Then check the wiring and peripheral device ratings to find the cause of the problem. Contact Yaskawa before energizing the drive or peripheral devices if the cause is not known.**

Failure to obey can cause death or serious injury and damage to the drive.

**NOTICE**

**Observe correct electrostatic discharge (ESD) procedures when touching the drive and circuit boards.**

Failure to obey can cause ESD damage to the drive circuitry.

**Do not connect or disconnect the motor from the drive while the drive is supplying voltage.**

Incorrect equipment sequencing can cause damage to the drive.

**Do not use unshielded wire for control wiring. Use shielded twisted-pair wires and ground the shield to the ground terminal of the drive.**

Failure to comply may cause electrical interference resulting in poor system performance.

**Do not allow unqualified personnel to use the product. Before you connect a dynamic braking option to the drive, make sure that you review Braking Unit and Braking Resistor Unit Installation Manual TOBPC72060001.**

Failure to obey can cause damage to the drive and braking circuit.

**Do not change the drive circuitry.**

Failure to obey can cause damage to the drive and will void warranty. Yaskawa is not responsible for modifications of the product made by the user.

**Make sure that all connections are correct after you install the drive and connecting peripheral devices.**

Failure to obey can cause damage to the drive.

## 4.2 European Standards



**Figure 4.1 CE Mark**

The CE Mark identifies that the product meets environmental and safety standards in the European Union. Products manufactured, sold, or imported in the European Union must display the CE Mark.

European Union standards include standards for electrical appliances (Low Voltage Directive), standards for electrical noise (EMC Directive), and standards for machinery (Machinery Directive).

This product displays the CE Mark in accordance with the Low Voltage Directive, the EMC Directive, and the Machinery Directive.

**Table 4.1 Harmonized Standard**

European Directive	Harmonized Standard
CE Low Voltage Directive Compliance 2014/35/EU	IEC/EN 61800-5-1:2007
EMC Directive 2014/30/EU	EN 61800-3 2004+A1:2012
Machinery Directive 2006/42/EC	<ul style="list-style-type: none"> <li>• EN ISO 13849-1/AC:2009 (PL e (Cat.III))</li> <li>• IEC 62061/A1:2012 (SIL CL 3)</li> <li>• EN 62061/A1:2013 (SIL CL 3)</li> <li>• IEC/EN 61800-5-2:2007 (SIL3)</li> </ul>

**Note:**

Identifies that the device or machine containing this product is covered by the CE Mark.

The customer must display the CE Mark on the final device containing this product. Customers must verify that the final device complies with EU standards.

## ◆ EU Declaration of Conformity

### EU Declaration of Conformity

Original

**YASKAWA**

Ref.No. VKOHIN-S1706-03

**YASKAWA ELECTRIC CORPORATION**  
 2-13-1 Nishimiyaichi Yukuhashi City  
 Fukuoka Pref., 824-8511 Japan

declares under sole responsibility conformity of the following products

GA700 Series AC Drive

Model: CIPR-GA70 □ □ □ □ □ □ □ □ - □ □ □ □

Directive of the European Parliament and Council:

Low Voltage Directive (LVD)	: 2014/35/EU
Electromagnetic Compatibility Directive (EMC)	: 2014/30/EU
Machine Directive (MD)	: 2006/42/EC
Restriction of the use of certain hazardous substances (RoHS)	: 2011/65/EU

Applied harmonized Standards:

EN 62061:2005/A1:2015 (SILCL3)  
 EN ISO 13849-1:2015 (Cat.3, PL e)  
 EN 61800-5-2:2007 (SIL3)  
 EN 61800-5-1:2007  
 EN 61800-3:2004/A1:2012  
 EN 61000-6-4:2007/A1:2011  
 EN 61000-6-2:2005  
 EN 50581:2012

**YASKAWA ELECTRIC CORPORATION**  
 2-13-1 Nishimiyaichi Yukuhashi City  
 Fukuoka Pref., 824-8511 Japan

9<sup>th</sup>.June.2017


V - Factory  
 Please fill in title

Nobuaki Jinnouchi

**EU Declaration of Conformity**

Translation – German | French | Italian | Spanish | Portuguese

**YASKAWA**

Ref.No. VKOHIN-S1706-03

EG-Konformitätserklärung | Déclaration de conformité CE  
 Dichiarazione di conformità CE | Declaración de Conformidad de la CE  
 Declaração de Conformidade CE

**YASKAWA ELECTRIC CORPORATION**

2-13-1 Nishimiyaichi Yukuhashi City  
 Fukuoka Pref., 824-8511 Japan

**declares under sole responsibility conformity of the following products**

erklärt in alleiniger Verantwortung die Konformität für folgende Produkte  
 déclare, sous sa seule responsabilité, que-les produits  
 dichiara sotto la propria esclusiva responsabilità la conformità dei seguenti prodotti  
 bajo su exclusiva responsabilidad la conformidad para los siguientes productos  
 declara, sob a sua exclusiva responsabilidade, a conformidade dos seguintes produtos

GA700 Series AC Drive

Model: CIPR-GA70         -      **Directive of the European Parliament and Council**

Richtlinie des Europäischen Parlamentes und Rates / Directive du Parlement européen et du Conseil  
 Direttiva del Parlamento europeo e del Consiglio / Directiva del Parlamento Europeo y del Consejo /  
 Diretiva do Parlamento Europeu e do Conselho

**Low Voltage Directive (LVD)**

: 2014/35/EU

Niederspannungsrichtlinie / Directive Basse Tension  
 Direttiva sulla bassa tensione / Directiva de Baja Tensión / Diretiva "Baixa Tensão"

**Electromagnetic Compatibility Directive (EMC)**

: 2014/30/EU

EMV-Richtlinie / Directive CEM  
 Direttiva EMC / Directiva sobre Compatibilidad Electromagnética / Diretiva CEM

**Machine Directive (MD)**

: 2006/42/EC

Maschinenrichtlinie / Directive machines  
 Direttiva Macchine / Directiva de Máquinas / Directiva de máquinas

**Restriction of the use of certain Hazardous Substances (RoHS)**

: 2011/65/EU

Beschränkung der Verwendung bestimmter gefährlicher Stoffe in Elektro- und Elektronikgeräten.  
 Relative à la limitation de l'utilisation de certaines substances dangereuses dans les équipements électriques et électroniques.  
 Sulla restrizione dell'uso di determinate sostanze pericolose nelle apparecchiature elettriche ed elettroniche.  
 Sobre restricciones a la utilización de determinadas sustancias peligrosas en aparatos eléctricos y electrónicos.  
 Relativa à restrição do uso de determinadas substâncias perigosas em equipamentos eléctricos e electrónicos.

**Applied harmonized Standards:**

EN 62061:2005/A1:2015 (SILCL3)  
 EN ISO 13849-1:2015 (Cat.3, PL e)  
 EN 61800-5-2:2007 (SIL3)  
 EN 61800-5-1:2007

EN 50581:2012  
 EN 61000-6-2:2005  
 EN 61000-6-4:2007/A1:2011  
 EN 61800-3:2004/A1:2012

**Place / Date**

Ort, Datum / Lieu et date / Luogo, data / Lugar, Fecha / Local, data

**YASKAWA ELECTRIC CORPORATION**

2-13-1 Nishimiyaichi Yukuhashi City  
 Fukuoka Pref., 824-8511 Japan

9<sup>th</sup>, June , 2017

Drives Division  
 General Manager



Nobuaki Jinnouchi



**EU Declaration of Conformity**

Translation – Dutch | Irish | Greek | Bulgarian | Romanian

**YASKAWA**

Ref.No. VKOHIN-S1706-03

EG-conformiteitsverklaring | Dearbhú Comhréireachta AE  
 Δήλωση Συμμόρφωσης ΕΚ | ΕΟ-Декларация за съответствие  
 Declarație de conformitate CE

**YASKAWA ELECTRIC CORPORATION**

2-13-1 Nishimiyaichi Yukuhashi City  
 Fukuoka Pref., 824-8511 Japan

**declares under sole responsibility conformity of the following products**

verklaart onder eigen verantwoordelijkheid de conformiteit van de volgende producten  
 a dhearbhaíonn faoi fhreagracht aonair comhréireacht na dtáirgí seo a leanas  
 επιβεβαιώνει, με αποκλειστική του ευθύνη, τη συμμόρφωση των ακόλουθων προϊόντων  
 декларира на собствена отговорност съответствието на следния продукт  
 declară pe răspunderea sa exclusivă conformitatea următoarelor produse

GA700 Series AC Drive

Model: CIPR-GA70 □ □ □ □ □ □ □ □ - □ □ □ □ □ □

**Directive of the European Parliament and Council**

Richtlijn van het Europese Parlement en de Europese Raad  
 Treoir ó Pharlaimint na hEoipa agus ón gComhairle / Οδηγία του Ευρωπαϊκού Κοινοβουλίου και του Συμβουλίου  
 Директива на Европейския парламент и Съвета / Directiva Parlamentului European și a Consiliului

**Low Voltage Directive (LVD)**

: 2014/35/EU

Laagspanningsrichtlijn / Treoir maidir le hÍsealvoltagas  
 Οδηγία για τη χαμηλή τάση / Директивата за ниско напрежение  
 Directive voltaj scăzut

**Electromagnetic Compatibility Directive (EMC)**

: 2014/30/EU

EMC-richtlijn / Treoir maidir le Comhoiriúnacht Leictreamaighnéadach  
 Οδηγία ηλεκτρομαγνητικής συμβατότητας (EMC) / Директива за електромагнитна съвместимост  
 Directive CEM

**Machine Directive (MD)**

: 2006/42/EC

Machinerichtlijn / Treoir maidir le hInnill (MD)  
 Οδηγία για τα μηχανήματα / Директива Машини (DM) / Directivă mașinărie

**A Restriction of the use of certain hazardous substances (RoHS)**

: 2011/65/EU

Betreffende beperking van het gebruik van bepaalde gevaarlijke stoffen in elektrische en elektronische apparatuur.  
 για τον περιορισμό της χρήσης ορισμένων επικίνδυνων ουσιών σε ηλεκτρικό και ηλεκτρονικό εξοπλισμό.  
 относно ограничението за употребата на определени опасни вещества в електрическото и електронното оборудване.  
 Privind restricțiile de utilizare a anumitor substanțe periculoase în echipamentele electrice și electronice.

**Applied harmonized Standards:**

EN 62061:2005/A1:2015 (SILCL3)	EN 50581:2012
EN ISO 13849-1:2015 (Cat.3, PL e)	EN 61000-6-2:2005
EN 61800-5-2:2007 (SIL3)	EN 61000-6-4:2007/A1:2011
EN 61800-5-1:2007	EN 61800-3:2004/A1:2012


**Place / Date**

Plaats, Datum / Áit, Dáta / Τόπος, ημερομηνία / Место, Дата / Locul, data

**YASKAWA ELECTRIC CORPORATION**

2-13-1 Nishimiyaichi Yukuhashi City

Fukuoka Pref., 824-8511 Japan

9<sup>th</sup>, June, 2017


Drives Division  
 General Manager

Nobuaki Jinnouchi

**EU Declaration of Conformity**

Translation – Polish | Lithuanian | Czech | Slovak | Hungarian

**YASKAWA**

Ref.No. VKOHIN-S1706-03

Deklaracja zgodności WE | EB atitikties deklaracija  
 ES Prohlášení o shodě | Vyhlásenie o zhode ES  
 EK megfeleléségi nyilatkozat

**YASKAWA ELECTRIC CORPORATION**  
 2-13-1 Nishimiyaichi Yukuhashi City  
 Fukuoka Pref., 824-8511 Japan

**declares under sole responsibility conformity of the following products**

oświadcza z wyłączną odpowiedzialnością, że niżej wymienione wyroby są zgodne z odpowiednimi przepisami unijnymi  
 prisiimdama atsakomybę patvirtina toliau nurodytų gaminių atitikį  
 Prohlašuje na svou výhradní odpovědnost shodu níže uvedených výrobků  
 potvrdzuje vylučnú zodpovednosť za zhodu pre nasledujúce výrobky  
 saját kizárólagos felelősségére kijelenti, hogy a következő termékek megfelelnek az alábbiakban megfogalmazott követelményeknek

GA700 Series AC Drive

Model: CIPR-GA70         -      **Directive of the European Parliament and Council**

Dyrektýwa Parlamentu Europejskiego i Rady / Europsos Parlamento ir Tarybos direktyva  
 Směrnice Evropského parlamentu a Rady / Smernice Európskeho parlamentu a Rady  
 Az Európai Parlament és az Európai Tanács irányelve

**Low Voltage Directive (LVD)**

: 2014/35/EU

Dyrektýwa dot. niskich napięć / Žemos įtampos direktyva  
 Směrnice o zařízeních nízkého napětí / Smernica o nízkom napätí  
 Kisfeszültségű szűlő irányelv

**Electromagnetic Compatibility Directive (EMC)**

: 2014/30/EU

Dyrektýwa EMC / EMS direktyva / Směrnice o elektromagnetické kompatibilitě  
 Smernica EMC / Elektromágneses összeférhetőségről szűlő irányelv

**Machine Directive (MD)**

: 2006/42/EC

Dyrektýwa w sprawie maszyn / Direktyva dėl mašinų  
 Směrnice o strojních zařízeních / Smernica o strojových zariadeniach / Gépekről szűlő irányelv

**Restriction of the use of certain hazardous substances (RoHS)**

: 2011/65/EU

W sprawie ograniczenia stosowania niektórych niebezpiecznych substancji w sprzęcie elektrycznym i elektronicznym.  
 Dėl tam tikrų pavojingų medžiagų naudojimo elektros ir elektroninėje įrangoje aparatuose.  
 O omezení používání některých nebezpečných látek v elektrických a elektronických zařízeních.  
 O obmedzení používania určitých nebezpečných látok v elektrických a elektronických zariadeniach.  
 Egyes veszélyes anyagok elektromos és elektronikus berendezésekben való alkalmazásának korlátozásáról.

**Applied harmonized Standards:**

EN 62061:2005/A1:2015 (SILCL3)	EN 50581:2012
EN ISO 13849-1:2015 (Cat.3, PL e)	EN 61000-6-2:2005
EN 61800-5-2:2007 (SIL3)	EN 61000-6-4:2007/A1:2011
EN 61800-5-1:2007	EN 61800-3:2004/A1:2012

**Place / Date**

Miejscowość, data / Vieta, data / Misto, datum / Miesto, dátum / Hely, dátum

**YASKAWA ELECTRIC CORPORATION**  
 2-13-1 Nishimiyaichi Yukuhashi City  
 Fukuoka Pref., 824-8511 Japan

9<sup>th</sup>, June, 2017

Drives Division  
 General Manager



Nobuaki Jinnouchi

**EU Declaration of Conformity**

Translation - Danish | Swedish | Finnish | Latvian | Estonian

**YASKAWA**

Ref.No. VKOHIN-S1706-03

EF-overensstemmelseserklæring | EG-försäkran om överensstämmelse  
 EY-vaatimustenmukaisuusvakuutus | EK atbilstības deklarācija  
 EÜ vastavusdeklaratsioon

**YASKAWA ELECTRIC CORPORATION**

2-13-1 Nishimiyaichi Yukuhashi City  
 Fukuoka Pref., 824-8511 Japan

**declares under sole responsibility conformity of the following products**

erklærer som eneste ansvarlig overensstemmelsen for følgende produkter  
 försäkrar på eget ansvar att följande produkter uppfyller kraven på överensstämmelse  
 vakuuttaa yksinomaisella vastuullaan seuraavien tuotteiden vaatimustenmukaisuuden  
 uz savu atbildību paziņo par tālāk minēto izstrādājumu atbilstību  
 deklareerib ainuvastutusel järgmiste toodete vastavust

GA700 Series AC Drive

Model: CIPR-GA70 □ □ □ □ □ □ □ □ - □ □ □ □ □ □

**Directive of the European Parliament and Council**

Europa-Parlamentets og Rådets direktiv / EU-direktiv / Euroopan parlamentin ja neuvoston direktiivi  
 Euroopas Parlamenta un Padomes Direktīva / Euroopa Parlamendi ja nõukogu direktiiv

**Low Voltage Directive (LVD)**

: 2014/35/EU

Lavspændingsdirektivet / Lågspänningsdirektivet / Pienjännitedirektiivi  
 Zemsprieguma direktīva / Madalpingedirektiiv

**Electromagnetic Compatibility Directive (EMC)**

: 2014/30/EU

EMC-direktivet / EMC-direktivet / EMC-direktiivi  
 EMS direktīva / Elektromagnētīse ūhilduvuse direktiiv

**Machine Directive (MD)**

: 2006/42/EC

Maskindirektivet / Maskindirektivet / Konedirektiivi  
 Mašīnu direktīva / Masinadirektiiv

**Restriction of the use of certain hazardous substances (RoHS)**

: 2011/65/EU

Om begrænsning af anvendelsen af visse farlige stoffer i elektrisk og elektronisk udstyr.  
 Om begränsning av användning av vissa farliga ämnen i elektrisk och elektronisk utrustning.  
 Tiettyjen vaarallisten aineiden käytön rajoittamisesta sähkö- ja elektroniikkalaitteissa.  
 Par dažu bīstamu vielu izmantošanas ierobežošanu elektriskās un elektroniskās iekārtās.  
 Dēļ tam tikrų pavojingų medžiagų naudojimo elektros ir elektroninėje įrangoje apribojimo.

**Applied harmonized Standards:**

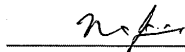
EN 62061:2005/A1:2015 (SILCL3)	EN 50581:2012
EN ISO 13849-1:2015 (Cat.3, PL e)	EN 61000-6-2:2005
EN 61800-5-2:2007 (SIL3)	EN 61000-6-4:2007/A1:2011
EN 61800-5-1:2007	EN 61800-3:2004/A1:2012

**Place / Date**

By, dato / Ort och datum / Paikka, pvm / Vieta, datums / Koht, kuupäev

**YASKAWA ELECTRIC CORPORATION**

2-13-1 Nishimiyaichi Yukuhashi City  
 Fukuoka Pref., 824-8511 Japan

9<sup>th</sup>, June, 2017


Drives Division  
 General Manager

Nobuaki Jinnouchi

**EU Declaration of Conformity**

Translation - Croatian | Slovene | Maltese

**YASKAWA**

Ref.No. VKOHIN-S1706-03

**EZ Izjava o skladnosti | Deklaracija o skladnosti ES  
Dikjarazzjoni tal-KE dwar il-Konformità****YASKAWA ELECTRIC CORPORATION**  
2-13-1 Nishimiyaichi Yukuhashi City  
Fukuoka Pref., 824-8511 Japan**declares under sole responsibility conformity of the following products**pod isključivom odgovornošću izjavljuje sukladnost sljedećih proizvoda  
na lastno odgovornost potrjuje skladnost naslednjih izdelkov  
tiddikjara taht ir-responsabbiltà unika taghha l-konformità tal-prodotti li gejjin

GA700 Series AC Drive

**Model:** CIPR-GA70 □ □ □ □ □ □ □ □ - □ □ □ □ □ □**Directive of the European Parliament and Council**Direktiva Europskog parlamenta i Vijeća / Direktiva Evropskega parlamenta in Sveta  
Eiropas Parlamenta un Padomes Direktīva / Euroopa Parlamendi ja nõukogu direktiv  
Direttiva tal-Parlament Ewropew u tal-Kunsill**Low Voltage Directive (LVD)**

: 2014/35/EU

Direktiva o niskom naponu / Niskonapetostna direktiva  
Direttiva dwar il-Voltaġġ Baxx**Electromagnetic Compatibility Directive (EMC)**

: 2014/30/EU

Direktiva o elektromagnetskoj kompatibilnosti (EMC) / EMC direktiva  
Direttiva dwar l-EMC**Machine Directive (MD)**

: 2006/42/EC

Direktiva o strojevima / Direktiva o strojih  
Direttiva dwar il-Makkinarju (MD)**Restriction of the use of certain hazardous substances (RoHS)**

: 2011/65/EU

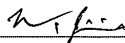
O ograničenju uporabe određenih opasnih tvari u električnoj i elektroničkoj opremi.  
O omejevanju uporabe nekaterih nevarnih snovi v električni in elektronski opremi.  
Dwar ir-restrizzjoni tal-użu ta' certi sustanzi perikoluzi fit-taghmir eletriku u elettroniku.**Applied harmonized Standards:**EN 62061:2005/A1:2015 (SILCL3)  
EN ISO 13849-1:2015 (Cat.3, PL e)  
EN 61800-5-2:2007 (SIL3)  
EN 61800-5-1:2007EN 50581:2012  
EN 61000-6-2:2005  
EN 61000-6-4:2007/A1:2011  
EN 61800-3:2004/A1:2012**Place / Date**

Mjesto, datum / Kraj, datum / Post, Data

**YASKAWA ELECTRIC CORPORATION**

2-13-1 Nishimiyaichi Yukuhashi City

Fukuoka Pref., 824-8511 Japan

9<sup>th</sup>, June, 2017Drives Division  
General Manager

Nobuaki Jinnouchi

**◆ CE Low Voltage Directive Compliance**

It has been confirmed that this product complies with the CE Low Voltage Directive by conducting a test according to IEC/EN 61800-5-1:2007.

The following conditions must be satisfied for machines and devices incorporating this product to comply with the CE Low Voltage Directive.

#### ■ Area of Use

Install this product in a location with overvoltage category III and pollution degree 2 or less. These standards are defined by IEC/EN 60664.

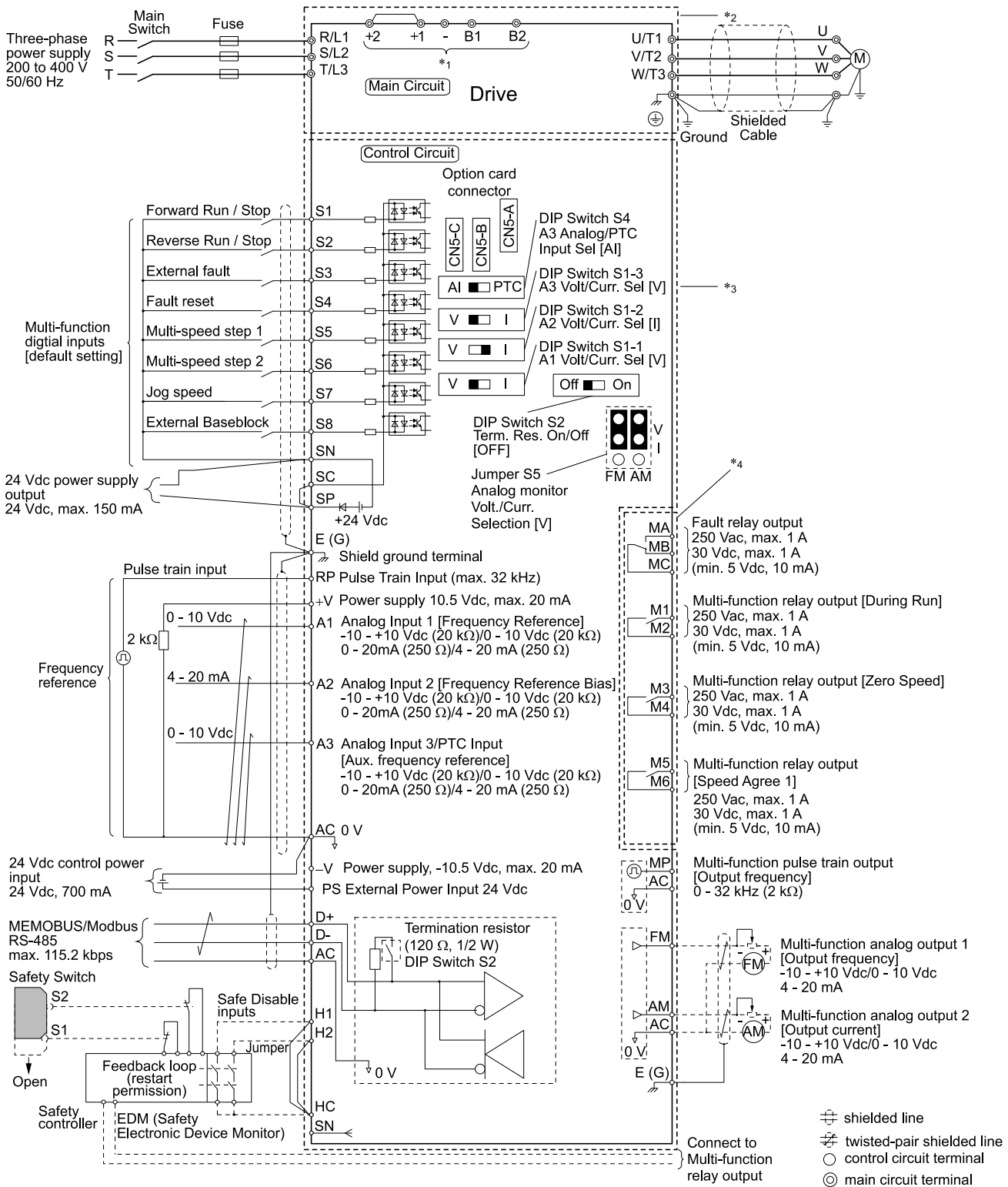
#### ■ Guarding against Debris

When installing IP20 enclosure drives (model: 2xxxB, 4xxxB), use an enclosure that does not let unwanted material enter the drive from above or below.

#### ■ Wiring Diagram

Refer to [Figure 4.2](#) for an example of a drive that is wired to comply with the CE Low Voltage Directive.

## 4.2 European Standards



**Figure 4.2 Wiring Diagram for CE Low Voltage Directive Compliance**

\*1 Connect peripheral options to terminals -, +1, +2, B1, and B2.

**WARNING! Electrical Shock Hazard.** Use terminals -, +1, +2, B1, and B2 to connect options to the drive. Do not connect an AC power supply lines to these terminals. Failure to obey can cause death or serious injury.

\*2 For circuit protection, the main circuit is separated from the surface case that can touch the main circuit.

\*3 The control circuit is a Safety Extra-Low Voltage circuit. Separate this circuit from other circuits with reinforced insulation. Make sure that the Safety Extra-Low Voltage circuit is connected as specified.

\*4 Reinforced insulation separates the output terminals from other circuits. Users can also connect circuits that are not Safety Extra-Low Voltage circuits if the drive output is 250 Vac 1 A max. or 30 Vdc 1 A maximum.

## ■ Main Circuit Wire Gauges and Tightening Torques

**WARNING!** *Electrical Shock Hazard. Only connect peripheral options, for example a DC reactor or braking resistor, to terminals +1, +2, +3, -, B1, and B2. Failure to obey can cause death or serious injury.*

### Note:

- Yaskawa recommends wire gauges using drive continuous current ratings of 75 °C (167 °F) 600 V class 2 heat-resistant indoor PVC wire. Assume these conditions:
  - Ambient temperature: 40 °C (104 °F) or lower
  - Wiring distance: 100 m (3281 ft.) or shorter
  - Normal Duty Rated current value
- Refer to the instruction manual for each device for recommended wire gauges to connect peripheral devices or options to terminals +1, +2, +3, -, B1, and B2. Contact Yaskawa or your nearest sales representative if the recommended wire gauges for the peripheral devices or options are out of the range of the applicable gauges for the drive.

### Three-Phase 200 V Class

Model	Terminals	Recommended Gauge mm <sup>2</sup>	Applicable Gauge (IP20 Applicable Gauge *) mm <sup>2</sup>	Wire Stripping Length *2 mm	Terminal Screw		Tightening Torque N·m (lb·in.)
					Size	Shape	
2004	R/L1, S/L2, T/L3	2.5	2.5 - 10 (2.5 - 10)	10	M4	Slotted (-)	1.5 - 1.7 (13.5 - 15)
	U/T1, V/T2, W/T3	2.5	2.5 - 10 (2.5 - 10)	10	M4	Slotted (-)	1.5 - 1.7 (13.5 - 15)
	-, +1, +2	2.5	2.5 - 16 (2.5 - 16)	18	M5	Slotted (-)	2.3 - 2.5 (19.8 - 22) *3
	B1, B2	2.5	2.5 - 4 (2.5 - 4)	10	M4	Slotted (-)	1.5 - 1.7 (13.5 - 15)
	⊕	2.5 *4	2.5 - 10 (-)	-	M4	Phillips/slotted combo	1.2 - 1.5 (10.6 - 13.3)
2006	R/L1, S/L2, T/L3	2.5	2.5 - 10 (2.5 - 10)	10	M4	Slotted (-)	1.5 - 1.7 (13.5 - 15)
	U/T1, V/T2, W/T3	2.5	2.5 - 10 (2.5 - 10)	10	M4	Slotted (-)	1.5 - 1.7 (13.5 - 15)
	-, +1, +2	2.5	2.5 - 16 (2.5 - 16)	18	M5	Slotted (-)	2.3 - 2.5 (19.8 - 22) *3
	B1, B2	2.5	2.5 - 4 (2.5 - 4)	10	M4	Slotted (-)	1.5 - 1.7 (13.5 - 15)
	⊕	2.5 *4	2.5 - 10 (-)	-	M4	Phillips/slotted combo	1.2 - 1.5 (10.6 - 13.3)
2010	R/L1, S/L2, T/L3	2.5	2.5 - 10 (2.5 - 10)	10	M4	Slotted (-)	1.5 - 1.7 (13.5 - 15)
	U/T1, V/T2, W/T3	2.5	2.5 - 10 (2.5 - 10)	10	M4	Slotted (-)	1.5 - 1.7 (13.5 - 15)
	-, +1, +2	2.5	2.5 - 16 (2.5 - 16)	18	M5	Slotted (-)	2.3 - 2.5 (19.8 - 22) *3
	B1, B2	2.5	2.5 - 4 (2.5 - 4)	10	M4	Slotted (-)	1.5 - 1.7 (13.5 - 15)
	⊕	2.5 *4	2.5 - 10 (-)	-	M4	Phillips/slotted combo	1.2 - 1.5 (10.6 - 13.3)

## 4.2 European Standards

Model	Terminals	Recommended Gauge mm <sup>2</sup>	Applicable Gauge (IP20 Applicable Gauge <sup>*1</sup> ) mm <sup>2</sup>	Wire Stripping Length <sup>*2</sup> mm	Terminal Screw		Tightening Torque N·m (lb·in.)
					Size	Shape	
2012	R/L1, S/L2, T/L3	2.5	2.5 - 10 (2.5 - 10)	10	M4	Slotted (-)	1.5 - 1.7 (13.5 - 15)
	U/T1, V/T2, W/T3	2.5	2.5 - 10 (2.5 - 10)	10	M4	Slotted (-)	1.5 - 1.7 (13.5 - 15)
	-, +1, +2	2.5	2.5 - 16 (2.5 - 16)	18	M5	Slotted (-)	2.3 - 2.5 (19.8 - 22) <sup>*3</sup>
	B1, B2	2.5	2.5 - 4 (2.5 - 4)	10	M4	Slotted (-)	1.5 - 1.7 (13.5 - 15)
	⊕	2.5 <sup>*4</sup>	2.5 - 10 (-)	-	M4	Phillips/slotted combo	1.2 - 1.5 (10.6 - 13.3)
2018	R/L1, S/L2, T/L3	2.5	2.5 - 10 (2.5 - 10)	10	M4	Slotted (-)	1.5 - 1.7 (13.5 - 15)
	U/T1, V/T2, W/T3	2.5	2.5 - 10 (2.5 - 10)	10	M4	Slotted (-)	1.5 - 1.7 (13.5 - 15)
	-, +1, +2	4	2.5 - 16 (2.5 - 16)	18	M5	Slotted (-)	2.3 - 2.5 (19.8 - 22) <sup>*3</sup>
	B1, B2	2.5	2.5 - 4 (2.5 - 4)	10	M4	Slotted (-)	1.5 - 1.7 (13.5 - 15)
	⊕	2.5 <sup>*4</sup>	2.5 - 10 (-)	-	M4	Phillips/slotted combo	1.2 - 1.5 (10.6 - 13.3)
2021	R/L1, S/L2, T/L3	6	2.5 - 10 (2.5 - 10)	10	M4	Slotted (-)	1.5 - 1.7 (13.5 - 15)
	U/T1, V/T2, W/T3	2.5	2.5 - 10 (2.5 - 10)	10	M4	Slotted (-)	1.5 - 1.7 (13.5 - 15)
	-, +1, +2	6	2.5 - 16 (2.5 - 16)	18	M5	Slotted (-)	2.3 - 2.5 (19.8 - 22) <sup>*3</sup>
	B1, B2	2.5	2.5 - 4 (2.5 - 4)	10	M4	Slotted (-)	1.5 - 1.7 (13.5 - 15)
	⊕	6 <sup>*4</sup>	4 - 10 (-)	-	M4	Phillips/slotted combo	1.2 - 1.5 (10.6 - 13.3)
2030	R/L1, S/L2, T/L3	10	2.5 - 10 (2.5 - 10)	10	M4	Slotted (-)	1.5 - 1.7 (13.5 - 15)
	U/T1, V/T2, W/T3	6	2.5 - 10 (2.5 - 10)	10	M4	Slotted (-)	1.5 - 1.7 (13.5 - 15)
	-, +1, +2	10	2.5 - 16 (2.5 - 16)	18	M5	Slotted (-)	2.3 - 2.5 (19.8 - 22) <sup>*3</sup>
	B1, B2	2.5	2.5 - 4 (2.5 - 4)	10	M4	Slotted (-)	1.5 - 1.7 (13.5 - 15)
	⊕	10	6 - 10 (-)	-	M5	Phillips/slotted combo	2.0 - 2.5 (17.7 - 22.1)



Model	Terminals	Recommended Gauge mm <sup>2</sup>	Applicable Gauge (IP20 Applicable Gauge <sup>*/</sup> ) mm <sup>2</sup>	Wire Stripping Length <sup>*2</sup> mm	Terminal Screw		Tightening Torque N·m (lb·in.)
					Size	Shape	
2042	R/L1, S/L2, T/L3	10	2.5 - 10 (2.5 - 10)	10	M4	Slotted (-)	1.5 - 1.7 (13.5 - 15)
	U/T1, V/T2, W/T3	10	2.5 - 10 (2.5 - 10)	10	M4	Slotted (-)	1.5 - 1.7 (13.5 - 15)
	-, +1, +2	16	2.5 - 16 (2.5 - 16)	18	M5	Slotted (-)	2.3 - 2.5 (19.8 - 22) <sup>*3</sup>
	B1, B2	4	2.5 - 4 (2.5 - 4)	10	M4	Slotted (-)	1.5 - 1.7 (13.5 - 15)
	⊕	10	6 - 10 (-)	-	M5	Phillips/slotted combo	2.0 - 2.5 (17.7 - 22.1)
2056	R/L1, S/L2, T/L3	25	2.5 - 25 (10 - 25)	18	M5	Slotted (-)	2.3 - 2.5 (19.8 - 22) <sup>*3</sup>
	U/T1, V/T2, W/T3	16	2.5 - 16 (6 - 16)	18	M5	Slotted (-)	2.3 - 2.5 (19.8 - 22) <sup>*3</sup>
	-, +1, +2	35	2.5 - 35 (10 - 35)	20	M6	Hex socket cap (WAF: 5 mm)	5 - 5.5 (45 - 49)
	B1, B2	10	2.5 - 10 (2.5 - 10)	10	M4	Slotted (-)	1.5 - 1.7 (13.5 - 15)
	⊕	16	10 - 16 (-)	-	M6	Phillips/slotted combo	5.4 - 6.0 (47.8 - 53.1)
2070	R/L1, S/L2, T/L3	35	2.5 - 35 (25 - 35)	20	M6	Hex socket cap (WAF: 5 mm)	5 - 5.5 (45 - 49)
	U/T1, V/T2, W/T3	16	2.5 - 16 (16)	20	M6	Hex socket cap (WAF: 5 mm)	5 - 5.5 (45 - 49)
	-, +1, +2	50	2.5 - 50 (35 - 50)	20	M6	Hex socket cap (WAF: 5 mm)	5 - 5.5 (45 - 49)
	B1, B2	10	2.5 - 10 (2.5 - 10)	10	M4	Slotted (-)	1.5 - 1.7 (13.5 - 15)
	⊕	16	16 - 25 (-)	-	M6	Phillips/slotted combo	5.4 - 6.0 (47.8 - 53.1)
2082	R/L1, S/L2, T/L3	35	2.5 - 35 (25 - 35)	20	M6	Hex socket cap (WAF: 5 mm)	5 - 5.5 (45 - 49)
	U/T1, V/T2, W/T3	25	2.5 - 25 (16 - 25)	20	M6	Hex socket cap (WAF: 5 mm)	5 - 5.5 (45 - 49)
	-, +1, +2	50	2.5 - 50 (35 - 50)	20	M6	Hex socket cap (WAF: 5 mm)	5 - 5.5 (45 - 49)
	B1, B2	16	2.5 - 16 (2.5 - 16)	10	M4	Slotted (-)	1.5 - 1.7 (13.5 - 15)
	⊕	16	16 - 25 (-)	-	M6	Phillips/slotted combo	5.4 - 6.0 (47.8 - 53.1)

## 4.2 European Standards

Model	Terminals	Recommended Gauge mm <sup>2</sup>	Applicable Gauge (IP20 Applicable Gauge <sup>*/1</sup> ) mm <sup>2</sup>	Wire Stripping Length <sup>*/2</sup> mm	Terminal Screw		Tightening Torque N·m (lb·in.)
					Size	Shape	
2110	R/L1, S/L2, T/L3	35	16 - 35 (25 - 35)	27	M6	Hex socket cap (WAF: 5 mm)	8 - 9 (71 - 80)
	U/T1, V/T2, W/T3	35	16 - 35 (25 - 35)	27	M6	Hex socket cap (WAF: 5 mm)	8 - 9 (71 - 80)
	-, +1	50	25 - 50 (25 - 50)	27	M8	Hex socket cap (WAF: 6 mm)	10 - 12 (89 - 107)
	B1, B2	25	6 - 25 (6 - 25)	21	M6	Minus (-)	3 - 3.5 (27 - 31)
	⊕	16	16 - 25 (-)	-	M6	Hex bolt (+)	5.4 - 6.0 (47.8 - 53.1)
2138	R/L1, S/L2, T/L3	50	16 - 50 (50)	27	M6	Hex socket cap (WAF: 5 mm)	8 - 9 (71 - 80)
	U/T1, V/T2, W/T3	50	16 - 50 (50)	27	M6	Hex socket cap (WAF: 5 mm)	8 - 9 (71 - 80)
	-, +1	70	25 - 70 (50 - 70)	27	M8	Hex socket cap (WAF: 6 mm)	10 - 12 (89 - 107)
	B1, B2	35	6 - 35 (6 - 35)	21	M6	Minus (-)	3 - 3.5 (27 - 31)
	⊕	25	25 (-)	-	M6	Hex bolt (+)	5.4 - 6.0 (47.8 - 53.1)
2169	R/L1, S/L2, T/L3	70	50 - 95 (95)	37	M10	Hex socket cap (WAF: 8 mm)	12 - 14 (107 - 124)
	U/T1, V/T2, W/T3	70	50 - 95 (95)	37	M10	Hex socket cap (WAF: 8 mm)	12 - 14 (107 - 124)
	-, -, +1, +1 <sup>*5 *6</sup>	35	16 - 50 (50)	28	M6	Hex socket cap (WAF: 5 mm)	8 - 9 (71 - 80)
	+3 <sup>*6</sup>	50	25 - 70 (50 - 70)	28	M8	Hex socket cap (WAF: 6 mm)	8 - 9 (71 - 80)
	⊕	35	25 - 50 (-)	-	M8	Hex bolt (slotted)	9.0 - 11 (79.7 - 97.4)
2211	R/L1, S/L2, T/L3	95	50 - 95 (95)	37	M10	Hex socket cap (WAF: 8 mm)	12 - 14 (107 - 124)
	U/T1, V/T2, W/T3	95	50 - 95 (95)	37	M10	Hex socket cap (WAF: 8 mm)	12 - 14 (107 - 124)
	-, -, +1, +1 <sup>*5 *6</sup>	50	16 - 50 (50)	28	M6	Hex socket cap (WAF: 5 mm)	8 - 9 (71 - 80)
	+3 <sup>*6</sup>	70	25 - 70 (50 - 70)	28	M8	Hex socket cap (WAF: 6 mm)	8 - 9 (71 - 80)
	⊕	50	25 - 50 (-)	-	M8	Hex bolt (slotted)	9.0 - 11 (79.7 - 97.4)

Model	Terminals	Recommended Gauge mm <sup>2</sup>	Applicable Gauge (IP20 Applicable Gauge *) mm <sup>2</sup>	Wire Stripping Length *2 mm	Terminal Screw		Tightening Torque N·m (lb·in.)
					Size	Shape	
2257	R/L1, S/L2, T/L3	50 × 2P	25 - 95 × 2P (70 - 95 × 2P)	-	M10	Hex self-locking nut	20 (177)
	U/T1, V/T2, W/T3	50 × 2P	25 - 95 × 2P (70 - 95 × 2P)	-	M10	Hex self-locking nut	20 (177)
	-, +1	70 × 2P	35 - 120 × 2P (120 × 2P)	-	M10	Hex self-locking nut	20 (177)
	+3	35 × 2P	25 - 70 × 2P (70 × 2P)	-	M10	Hex self-locking nut	20 (177)
	⊕	95	95 - 240 (-)	-	M10	Hex bolt (slotted)	18 - 23 (159 - 204)
2313	R/L1, S/L2, T/L3	70 × 2P	25 - 95 × 2P (70 - 95 × 2P)	-	M10	Hex self-locking nut	20 (177)
	U/T1, V/T2, W/T3	70 × 2P	25 - 95 × 2P (70 - 95 × 2P)	-	M10	Hex self-locking nut	20 (177)
	-, +1	95 × 2P	35 - 120 × 2P (120 × 2P)	-	M10	Hex self-locking nut	20 (177)
	+3	50 × 2P	25 - 70 × 2P (70 × 2P)	-	M10	Hex self-locking nut	20 (177)
	⊕	95	95 - 240 (-)	-	M10	Hex bolt (slotted)	18 - 23 (159 - 204)
2360	R/L1, S/L2, T/L3	120 × 2P	70 - 150 × 2P (150 × 2P)	-	M12	Hex self-locking nut	35 (310)
	U/T1, V/T2, W/T3	120 × 2P	70 - 150 × 2P (150 × 2P)	-	M12	Hex self-locking nut	35 (310)
	-, +1	120 × 2P	95 - 185 × 2P (185 × 2P)	-	M12	Hex self-locking nut	35 (310)
	+3	70 × 2P	50 - 95 × 2P (-)	-	M12	Hex self-locking nut	35 (310)
	⊕	120	120 - 240 (-)	-	M12	Hex bolt (slotted)	32 - 40 (283 - 354)
2415	R/L1, S/L2, T/L3	120 × 2P	70 - 150 × 2P (150 × 2P)	-	M12	Hex self-locking nut	35 (310)
	U/T1, V/T2, W/T3	120 × 2P	70 - 150 × 2P (150 × 2P)	-	M12	Hex self-locking nut	35 (310)
	-, +1	120 × 2P	95 - 185 × 2P (185 × 2P)	-	M12	Hex self-locking nut	35 (310)
	+3	70 × 2P	50 - 95 × 2P (-)	-	M12	Hex self-locking nut	35 (310)
	⊕	120	120 - 240 (-)	-	M12	Hex bolt (slotted)	32 - 40 (283 - 354)

\*1 For IP20 protection, use wires that are in the range of applicable gauges.

\*2 Remove insulation from the ends of wires to expose the length of wire shown.

\*3 For wire gauges more than 30 mm<sup>2</sup>, tighten to a tightening torque of 4.1 N·m to 4.5 N·m (36 lb·in. to 40 lb·in.).

\*4 Install an RCM/RCD with this wire gauge to maintain compliance with IEC/EN 61800-5-1:2007.

\*5 Terminals - and +1 have two screws. The Recommended Gauge is the wire gauge for one terminal.

\*6 A junction terminal is necessary to connect a braking unit (CDBR-series) to terminals - and +3.

## 4.2 European Standards

### Three-Phase 400 V Class

Model	Terminals	Recommended Gauge mm <sup>2</sup>	Applicable Gauge (IP20 Applicable Gauge <sup>*1</sup> ) mm <sup>2</sup>	Wire Stripping Length <sup>*2</sup> mm	Terminal Screw		Tightening Torque N·m (lb·in.)
					Size	Shape	
4002	R/L1, S/L2, T/L3	2.5	2.5 - 10 (2.5 - 10)	10	M4	Slotted (-)	1.5 - 1.7 (13.5 - 15)
	U/T1, V/T2, W/T3	2.5	2.5 - 10 (2.5 - 10)	10	M4	Slotted (-)	1.5 - 1.7 (13.5 - 15)
	-, +1, +2	2.5	2.5 - 16 (2.5 - 16)	18	M5	Slotted (-)	2.3 - 2.5 (19.8 - 22) <sup>*3</sup>
	B1, B2	2.5	2.5 - 4 (2.5 - 4)	10	M4	Slotted (-)	1.5 - 1.7 (13.5 - 15)
	⊕	2.5 <sup>*4</sup>	2.5 - 10 (-)	-	M4	Phillips/slotted combo	1.2 - 1.5 (10.6 - 13.3)
4004	R/L1, S/L2, T/L3	2.5	2.5 - 10 (2.5 - 10)	10	M4	Slotted (-)	1.5 - 1.7 (13.5 - 15)
	U/T1, V/T2, W/T3	2.5	2.5 - 10 (2.5 - 10)	10	M4	Slotted (-)	1.5 - 1.7 (13.5 - 15)
	-, +1, +2	2.5	2.5 - 16 (2.5 - 16)	18	M5	Slotted (-)	2.3 - 2.5 (19.8 - 22) <sup>*3</sup>
	B1, B2	2.5	2.5 - 4 (2.5 - 4)	10	M4	Slotted (-)	1.5 - 1.7 (13.5 - 15)
	⊕	2.5 <sup>*4</sup>	2.5 - 10 (-)	-	M4	Phillips/slotted combo	1.2 - 1.5 (10.6 - 13.3)
4005	R/L1, S/L2, T/L3	2.5	2.5 - 10 (2.5 - 10)	10	M4	Slotted (-)	1.5 - 1.7 (13.5 - 15)
	U/T1, V/T2, W/T3	2.5	2.5 - 10 (2.5 - 10)	10	M4	Slotted (-)	1.5 - 1.7 (13.5 - 15)
	-, +1, +2	2.5	2.5 - 16 (2.5 - 16)	18	M5	Slotted (-)	2.3 - 2.5 (19.8 - 22) <sup>*3</sup>
	B1, B2	2.5	2.5 - 4 (2.5 - 4)	10	M4	Slotted (-)	1.5 - 1.7 (13.5 - 15)
	⊕	2.5 <sup>*4</sup>	2.5 - 10 (-)	-	M4	Phillips/slotted combo	1.2 - 1.5 (10.6 - 13.3)
4007	R/L1, S/L2, T/L3	2.5	2.5 - 10 (2.5 - 10)	10	M4	Slotted (-)	1.5 - 1.7 (13.5 - 15)
	U/T1, V/T2, W/T3	2.5	2.5 - 10 (2.5 - 10)	10	M4	Slotted (-)	1.5 - 1.7 (13.5 - 15)
	-, +1, +2	2.5	2.5 - 16 (2.5 - 16)	18	M5	Slotted (-)	2.3 - 2.5 (19.8 - 22) <sup>*3</sup>
	B1, B2	2.5	2.5 - 4 (2.5 - 4)	10	M4	Slotted (-)	1.5 - 1.7 (13.5 - 15)
	⊕	2.5 <sup>*4</sup>	2.5 - 10 (-)	-	M4	Phillips/slotted combo	1.2 - 1.5 (10.6 - 13.3)

Model	Terminals	Recommended Gauge mm <sup>2</sup>	Applicable Gauge (IP20 Applicable Gauge <sup>*1</sup> ) mm <sup>2</sup>	Wire Stripping Length <sup>*2</sup> mm	Terminal Screw		Tightening Torque N·m (lb·in.)
					Size	Shape	
4009	R/L1, S/L2, T/L3	2.5	2.5 - 10 (2.5 - 10)	10	M4	Slotted (-)	1.5 - 1.7 (13.5 - 15)
	U/T1, V/T2, W/T3	2.5	2.5 - 10 (2.5 - 10)	10	M4	Slotted (-)	1.5 - 1.7 (13.5 - 15)
	-, +1, +2	2.5	2.5 - 16 (2.5 - 16)	18	M5	Slotted (-)	2.3 - 2.5 (19.8 - 22) <sup>*3</sup>
	B1, B2	2.5	2.5 - 4 (2.5 - 4)	10	M4	Slotted (-)	1.5 - 1.7 (13.5 - 15)
	⊕	2.5 <sup>*4</sup>	2.5 - 10 (-)	-	M4	Phillips/slotted combo	1.2 - 1.5 (10.6 - 13.3)
4012	R/L1, S/L2, T/L3	2.5	2.5 - 10 (2.5 - 10)	10	M4	Slotted (-)	1.5 - 1.7 (13.5 - 15)
	U/T1, V/T2, W/T3	2.5	2.5 - 10 (2.5 - 10)	10	M4	Slotted (-)	1.5 - 1.7 (13.5 - 15)
	-, +1, +2	2.5	2.5 - 16 (2.5 - 16)	18	M5	Slotted (-)	2.3 - 2.5 (19.8 - 22) <sup>*3</sup>
	B1, B2	2.5	2.5 - 4 (2.5 - 4)	10	M4	Slotted (-)	1.5 - 1.7 (13.5 - 15)
	⊕	2.5 <sup>*4</sup>	2.5 - 10 (-)	-	M4	Phillips/slotted combo	1.2 - 1.5 (10.6 - 13.3)
4018	R/L1, S/L2, T/L3	2.5	2.5 - 10 (2.5 - 10)	10	M4	Slotted (-)	1.5 - 1.7 (13.5 - 15)
	U/T1, V/T2, W/T3	2.5	2.5 - 10 (2.5 - 10)	10	M4	Slotted (-)	1.5 - 1.7 (13.5 - 15)
	-, +1, +2	4	2.5 - 16 (2.5 - 16)	18	M5	Slotted (-)	2.3 - 2.5 (19.8 - 22) <sup>*3</sup>
	B1, B2	2.5	2.5 - 4 (2.5 - 4)	10	M4	Slotted (-)	1.5 - 1.7 (13.5 - 15)
	⊕	2.5 <sup>*4</sup>	2.5 - 10 (-)	-	M5	Phillips/slotted combo	2.0 - 2.5 (17.7 - 22.1)
4023	R/L1, S/L2, T/L3	6	2.5 - 10 (2.5 - 10)	10	M4	Slotted (-)	1.5 - 1.7 (13.5 - 15)
	U/T1, V/T2, W/T3	4	2.5 - 10 (2.5 - 10)	10	M4	Slotted (-)	1.5 - 1.7 (13.5 - 15)
	-, +1, +2	6	2.5 - 16 (2.5 - 16)	18	M5	Slotted (-)	2.3 - 2.5 (19.8 - 22) <sup>*3</sup>
	B1, B2	2.5	2.5 - 4 (2.5 - 4)	10	M4	Slotted (-)	1.5 - 1.7 (13.5 - 15)
	⊕	6 <sup>*4</sup>	4 - 10 (-)	-	M5	Phillips/slotted combo	2.0 - 2.5 (17.7 - 22.1)

## 4.2 European Standards

Model	Terminals	Recommended Gauge mm <sup>2</sup>	Applicable Gauge (IP20 Applicable Gauge <sup>*/</sup> ) mm <sup>2</sup>	Wire Stripping Length <sup>*2</sup> mm	Terminal Screw		Tightening Torque N·m (lb·in.)
					Size	Shape	
4031	R/L1, S/L2, T/L3	10	2.5 - 25 (10 - 25)	18	M5	Slotted (-)	2.3 - 2.5 (19.8 - 22) <sup>*3</sup>
	U/T1, V/T2, W/T3	6	2.5 - 16 (6 - 16)	18	M5	Slotted (-)	2.3 - 2.5 (19.8 - 22) <sup>*3</sup>
	-, +1, +2	10	2.5 - 35 (10 - 35)	20	M6	Hex socket cap (WAF: 5 mm)	5 - 5.5 (45 - 49)
	B1, B2	2.5	2.5 - 10 (2.5 - 10)	10	M4	Slotted (-)	1.5 - 1.7 (13.5 - 15)
	⊕	10	6 - 16 (-)	-	M6	Phillips/slotted combo	5.4 - 6.0 (47.8 - 53.1)
4038	R/L1, S/L2, T/L3	10	2.5 - 25 (10 - 25)	18	M5	Slotted (-)	2.3 - 2.5 (19.8 - 22) <sup>*3</sup>
	U/T1, V/T2, W/T3	6	2.5 - 16 (6 - 16)	18	M5	Slotted (-)	2.3 - 2.5 (19.8 - 22) <sup>*3</sup>
	-, +1, +2	16	2.5 - 35 (10 - 35)	20	M6	Hex socket cap (WAF: 5 mm)	5 - 5.5 (45 - 49)
	B1, B2	4	2.5 - 10 (2.5 - 10)	10	M4	Slotted (-)	1.5 - 1.7 (13.5 - 15)
	⊕	10	6 - 16 (-)	-	M6	Phillips/slotted combo	5.4 - 6.0 (47.8 - 53.1)
4044	R/L1, S/L2, T/L3	16	2.5 - 16 (4 - 16)	18	M5	Slotted (-)	2.3 - 2.5 (19.8 - 22) <sup>*3</sup>
	U/T1, V/T2, W/T3	10	2.5 - 10 (6 - 10)	18	M5	Slotted (-)	2.3 - 2.5 (19.8 - 22) <sup>*3</sup>
	-, +1, +2	25	2.5 - 25 (6 - 25)	18	M5	Slotted (-)	2.3 - 2.5 (19.8 - 22) <sup>*3</sup>
	B1, B2	6	2.5 - 6 (2.5 - 6)	10	M4	Slotted (-)	1.5 - 1.7 (13.5 - 15)
	⊕	16	10 - 25 (-)	-	M6	Phillips/slotted combo	5.4 - 6.0 (47.8 - 53.1)
4060	R/L1, S/L2, T/L3	16	2.5 - 16 (4 - 16)	18	M5	Slotted (-)	2.3 - 2.5 (19.8 - 22) <sup>*3</sup>
	U/T1, V/T2, W/T3	16	2.5 - 16 (6 - 16)	18	M5	Slotted (-)	2.3 - 2.5 (19.8 - 22) <sup>*3</sup>
	-, +1	25	2.5 - 25 (6 - 25)	18	M5	Slotted (-)	2.3 - 2.5 (19.8 - 22) <sup>*3</sup>
	B1, B2	10	2.5 - 10 (2.5 - 10)	10	M4	Slotted (-)	1.5 - 1.7 (13.5 - 15)
	⊕	16	10 - 25 (-)	-	M6	Phillips/slotted combo	5.4 - 6.0 (47.8 - 53.1)

Model	Terminals	Recommended Gauge mm <sup>2</sup>	Applicable Gauge (IP20 Applicable Gauge <sup>*/</sup> ) mm <sup>2</sup>	Wire Stripping Length <sup>*/2</sup> mm	Terminal Screw		Tightening Torque N·m (lb·in.)
					Size	Shape	
4075	R/L1, S/L2, T/L3	25	2.5 - 25 (2.5 - 25)	18	M5	Slotted (-)	2.3 - 2.5 (19.8 - 22) <sup>*/3</sup>
	U/T1, V/T2, W/T3	25	2.5 - 25 (2.5 - 25)	18	M5	Slotted (-)	2.3 - 2.5 (19.8 - 22) <sup>*/3</sup>
	-, +1	25	2.5 - 25 (4 - 25)	18	M5	Slotted (-)	2.3 - 2.5 (19.8 - 22) <sup>*/3</sup>
	B1, B2	10	2.5 - 10 (2.5 - 10)	10	M4	Slotted (-)	1.5 - 1.7 (13.5 - 15)
	⊕	16	16 - 25 (-)	-	M6	Hex bolt (+)	5.4 - 6.0 (47.8 - 53.1)
4089	R/L1, S/L2, T/L3	25	2.5 - 25 (10 - 25)	18	M5	Slotted (-)	2.3 - 2.5 (19.8 - 22) <sup>*/3</sup>
	U/T1, V/T2, W/T3	25	2.5 - 25 (10 - 25)	18	M5	Slotted (-)	2.3 - 2.5 (19.8 - 22) <sup>*/3</sup>
	-, +1	35	2.5 - 35 (16 - 35)	20	M6	Hex socket cap (WAF: 5 mm)	5 - 5.5 (45 - 49)
	B1, B2	16	2.5 - 16 (4 - 16)	18	M5	Slotted (-)	2.3 - 2.5 (19.8 - 22) <sup>*/3</sup>
	⊕	16	16 - 25 (-)	-	M6	Hex bolt (+)	5.4 - 6.0 (47.8 - 53.1)
4103	R/L1, S/L2, T/L3	35	16 - 50 (50)	27	M6	Hex socket cap (WAF: 5 mm)	8 - 9 (71 - 80)
	U/T1, V/T2, W/T3	35	16 - 50 (50)	27	M6	Hex socket cap (WAF: 5 mm)	8 - 9 (71 - 80)
	-, +1	50	25 - 70 (50 - 70)	27	M8	Hex socket cap (WAF: 6 mm)	10 - 12 (89 - 107)
	B1, B2	25	6 - 35 (6 - 35)	21	M6	Minus (-)	3 - 3.5 (27 - 31)
	⊕	16	16 - 25 (-)	-	M6	Hex bolt (+)	5.4 - 6.0 (47.8 - 53.1)
4140	R/L1, S/L2, T/L3	50	50 - 95 (95)	37	M10	Hex socket cap (WAF: 8 mm)	12 - 14 (107 - 124)
	U/T1, V/T2, W/T3	50	50 - 95 (95)	37	M10	Hex socket cap (WAF: 8 mm)	12 - 14 (107 - 124)
	-, -, +1, +1 <sup>*/5</sup>	25	16 - 50 (50)	28	M6	Hex socket cap (WAF: 5 mm)	8 - 9 (71 - 80)
	B1, B2 <sup>*/6</sup>	50	25 - 70 (50 - 70)	28	M8	Hex socket cap (WAF: 6 mm)	8 - 9 (71 - 80)
	⊕	25	25 - 50 (-)	-	M8	Hex bolt (slotted)	9.0 - 11 (79.7 - 97.4)

## 4.2 European Standards

Model	Terminals	Recommended Gauge mm <sup>2</sup>	Applicable Gauge (IP20 Applicable Gauge <sup>*/1</sup> ) mm <sup>2</sup>	Wire Stripping Length <sup>*/2</sup> mm	Terminal Screw		Tightening Torque N·m (lb·in.)
					Size	Shape	
4168	R/L1, S/L2, T/L3	70	50 - 95 (95)	37	M10	Hex socket cap (WAF: 8 mm)	12 - 14 (107 - 124)
	U/T1, V/T2, W/T3	70	50 - 95 (95)	37	M10	Hex socket cap (WAF: 8 mm)	12 - 14 (107 - 124)
	-, -, +1, +1 <sup>*/5</sup>	35	16 - 50 (50)	28	M6	Hex socket cap (WAF: 5 mm)	8 - 9 (71 - 80)
	B1, B2 <sup>*/6</sup>	50	25 - 70 (50 - 70)	28	M8	Hex socket cap (WAF: 6 mm)	8 - 9 (71 - 80)
	⊕	35	25 - 50 (-)	-	M8	Hex bolt (slotted)	9.0 - 11 (79.7 - 97.4)
4208	R/L1, S/L2, T/L3	50 × 2P	25 - 95 × 2P (70 - 95 × 2P)	-	M10	Hex self-locking nut	20 (177)
	U/T1, V/T2, W/T3	50 × 2P	25 - 95 × 2P (70 - 95 × 2P)	-	M10	Hex self-locking nut	20 (177)
	-, +1	70 × 2P	35 - 120 × 2P (120 × 2P)	-	M10	Hex self-locking nut	20 (177)
	+3	35 × 2P	25 - 70 × 2P (70 × 2P)	-	M10	Hex self-locking nut	20 (177)
	⊕	50	50 - 240 (-)	-	M10	Hex bolt (slotted)	18 - 23 (159 - 204)
4250	R/L1, S/L2, T/L3	50 × 2P	25 - 95 × 2P (70 - 95 × 2P)	-	M10	Hex self-locking nut	20 (177)
	U/T1, V/T2, W/T3	50 × 2P	25 - 95 × 2P (70 - 95 × 2P)	-	M10	Hex self-locking nut	20 (177)
	-, +1	70 × 2P	35 - 120 × 2P (120 × 2P)	-	M10	Hex self-locking nut	20 (177)
	+3	50 × 2P	25 - 70 × 2P (70 × 2P)	-	M10	Hex self-locking nut	20 (177)
	⊕	70	70 - 240 (-)	-	M10	Hex bolt (slotted)	18 - 23 (159 - 204)
4296	R/L1, S/L2, T/L3	70 × 2P	25 - 95 × 2P (70 - 95 × 2P)	-	M10	Hex self-locking nut	20 (177)
	U/T1, V/T2, W/T3	70 × 2P	25 - 95 × 2P (70 - 95 × 2P)	-	M10	Hex self-locking nut	20 (177)
	-, +1	95 × 2P	35 - 120 × 2P (120 × 2P)	-	M10	Hex self-locking nut	20 (177)
	+3	70 × 2P	25 - 70 × 2P (70 × 2P)	-	M10	Hex self-locking nut	20 (177)
	⊕	95	95 - 240 (-)	-	M10	Hex bolt (slotted)	18 - 23 (159 - 204)



Model	Terminals	Recommended Gauge mm <sup>2</sup>	Applicable Gauge (IP20 Applicable Gauge *) mm <sup>2</sup>	Wire Stripping Length *2 mm	Terminal Screw		Tightening Torque N·m (lb·in.)
					Size	Shape	
4371	R/L1, S/L2, T/L3	120 × 2P	70 - 150 × 2P (150 × 2P)	-	M12	Hex self-locking nut	35 (310)
	U/T1, V/T2, W/T3	120 × 2P	70 - 150 × 2P (150 × 2P)	-	M12	Hex self-locking nut	35 (310)
	-, +1	120 × 2P	95 - 185 × 2P (185 × 2P)	-	M12	Hex self-locking nut	35 (310)
	+3	70 × 2P	50 - 95 × 2P (-)	-	M12	Hex self-locking nut	35 (310)
	⊕	120	120 - 240 (-)	-	M12	Hex bolt (slotted)	32 - 40 (283 - 354)
4389	R/L1, S/L2, T/L3	120 × 2P	70 - 150 × 2P (150 × 2P)	-	M12	Hex self-locking nut	35 (310)
	U/T1, V/T2, W/T3	120 × 2P	70 - 150 × 2P (150 × 2P)	-	M12	Hex self-locking nut	35 (310)
	-, +1	120 × 2P	95 - 185 × 2P (185 × 2P)	-	M12	Hex self-locking nut	35 (310)
	+3	95 × 2P	50 - 95 × 2P (-)	-	M12	Hex self-locking nut	35 (310)
	⊕	95	35 - 240 (-)	-	M12	Hex bolt (slotted)	32 - 40 (283 - 354)
4453	R/L1, S/L2, T/L3 R1/L11, S1/L21, T1/L31	120 × 4P	70 - 150 × 4P (150 × 4P)	-	M12	Hex self-locking nut	35 (310)
	U/T1, V/T2, W/T3	95 × 4P	70 - 150 × 4P (120 - 150 × 4P)	-	M12	Hex self-locking nut	35 (310)
	-, +1	95 × 4P	95 - 185 × 4P (185 × 4P)	-	M12	Hex self-locking nut	35 (310)
	+3	70 × 4P	35 - 95 × 4P (95 × 4P)	-	M12	Hex self-locking nut	35 (310)
	⊕	150	50 - 150 (-)	-	M12	Hex bolt (slotted)	32 - 40 (283 - 354)
4568	R/L1, S/L2, T/L3 R1/L11, S1/L21, T1/L31	120 × 4P	70 - 150 × 4P (150 × 4P)	-	M12	Hex self-locking nut	35 (310)
	U/T1, V/T2, W/T3	95 × 4P	70 - 150 × 4P (120 - 150 × 4P)	-	M12	Hex self-locking nut	35 (310)
	-, +1	95 × 4P	95 - 185 × 4P (185 × 4P)	-	M12	Hex self-locking nut	35 (310)
	+3	70 × 4P	35 - 95 × 4P (95 × 4P)	-	M12	Hex self-locking nut	35 (310)
	⊕	95 × 2P	60 - 150 (-)	-	M12	Hex bolt (slotted)	32 - 40 (283 - 354)

## 4.2 European Standards

Model	Terminals	Recommended Gauge mm <sup>2</sup>	Applicable Gauge (IP20 Applicable Gauge <sup>*1</sup> ) mm <sup>2</sup>	Wire Stripping Length <sup>*2</sup> mm	Terminal Screw		Tightening Torque N·m (lb·in.)
					Size	Shape	
4675	R/L1, S/L2, T/L3 R1/L11, S1/L21, T1/L31	120 × 4P	70 - 150 × 4P (150 × 4P)	-	M12	Hex self-locking nut	35 (310)
	U/T1, V/T2, W/T3	95 × 4P	70 - 150 × 4P (120 - 150 × 4P)	-	M12	Hex self-locking nut	35 (310)
	-, +1	95 × 4P	95 - 185 × 4P (185 × 4P)	-	M12	Hex self-locking nut	35 (310)
	+3	70 × 4P	35 - 95 × 4P (95 × 4P)	-	M12	Hex self-locking nut	35 (310)
	⊕	95 × 2P	60 - 150 (-)	-	M12	Hex bolt (slotted)	32 - 40 (283 - 354)

\*1 For IP20 protection, use wires that are in the range of applicable gauges.

\*2 Remove insulation from the ends of wires to expose the length of wire shown.

\*3 For wire gauges more than 30 mm<sup>2</sup>, tighten to a tightening torque of 4.1 N·m to 4.5 N·m (36 lb·in. to 40 lb·in.).

\*4 Install an RCM/RCD with this wire gauge to maintain compliance with IEC/EN 61800-5-1:2007.

\*5 Terminals - and +1 have two screws. The Recommended Gauge is the wire gauge for one terminal.

\*6 A junction terminal is necessary to connect a braking resistor unit (LKEB-series) to terminals B1 and B2.

### ■ Connect a Fuse to the Input Side (Primary Side)

The drive circuit protection must comply with IEC/EN 61800-5-1:2007 for protection against a short circuit in the internal circuitry. Yaskawa recommends connecting semiconductor protection fuses on the input side for branch circuit protection.

**WARNING! Electrical Shock Hazard.** Do not immediately energize the drive or operate peripheral devices after the drive blows a fuse or trips an RCM/RCD. Wait for the time specified on the warning label at a minimum and make sure that all indicators are OFF. Then check the wiring and peripheral device ratings to find the cause of the problem. Contact Yaskawa before energizing the drive or peripheral devices if the cause is not known. Failure to obey can cause death or serious injury and damage to the drive.

**Table 4.2 Factory-Recommended Branch Circuit Protection (200 V Class)**

Drive Model	Semiconductor Protection Fuse Rated Current Manufacturer: EATON/Bussmann
2004	FWH-45B
2006	FWH-45B
2010	FWH-45B
2012	FWH-50B
2018	FWH-80B
2021	FWH-80B
2030	FWH-125B
2042	FWH-150B
2056	FWH-200B
2070	FWH-225A
2082	FWH-225A FWH-250A <sup>*1</sup>
2110	FWH-225A FWH-250A <sup>*1</sup>
2138	FWH-275A FWH-300A <sup>*1</sup>
2169	FWH-275A FWH-350A <sup>*1</sup>

Drive Model	Semiconductor Protection Fuse Rated Current Manufacturer: EATON/Bussmann
2211	FWH-325A FWH-450A <sup>*1</sup>
2257	FWH-600A
2313	FWH-800A
2360	FWH-1000A
2415	FWH-1000A

\*1 Yaskawa recommends a fuse with a large rated current for applications with repeated loads.

**Table 4.3 Factory-Recommended Branch Circuit Protection (400 V Class)**

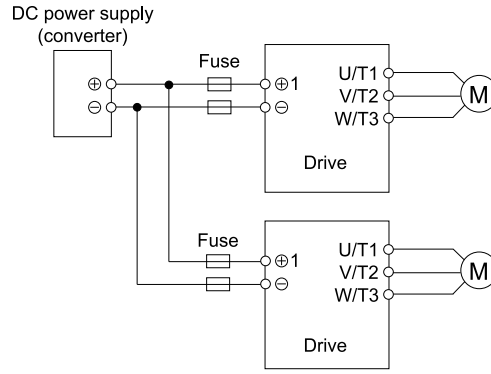
Drive Model	Semiconductor Protection Fuse Rated Current Manufacturer: EATON/Bussmann
4002	FWH-50B
4004	FWH-50B
4005	FWH-50B
4007	FWH-60B
4009	FWH-60B
4012	FWH-60B
4018	FWH-80B
4023	FWH-90B
4031	FWH-150B
4038	FWH-200B
4044	FWH-200B
4060	FWH-225A
4075	FWH-250A
4089	FWH-275A
4103	FWH-275A
4140	FWH-300A
4168	FWH-325A FWH-400A <sup>*1</sup>
4208	FWH-500A
4250	FWH-600A
4296	FWH-700A
4371	FWH-800A
4389	FWH-1000A
4453	FWH-1200A
4568	FWH-1200A
4675	FWH-1400A FWH-1600A <sup>*1</sup>

\*1 Yaskawa recommends a fuse with a large rated current for applications with repeated loads.

### ■ CE Standards Compliance for DC Power Supply Input

To comply with CE Standards, install a fuse for the DC power supply input.

Figure 4.3 shows a wiring example for a DC power supply that has two drives connected in parallel.



**Figure 4.3 Wiring Example for DC Power Supply Input**

**WARNING!** Do not ground the main circuit bus. Failure to obey can cause death or serious injury.

**Note:**

- Install a fuse for each drive when operating more than one drive. If one fuse blows, replace all fuses.
- Install the external filter (system) to comply with the EMC Directive.

Refer to [Table 4.4](#) and [Table 4.5](#) for the recommended fuses.

**Table 4.4 Recommended Fuse (Three-Phase 200 V Class)**

Drive Model	Fuse Manufacturer: Bussmann	
	Model	Quantity
2004	FWH-45B	2
2006	FWH-45B	2
2010	FWH-45B	2
2012	FWH-50B	2
2018	FWH-80B	2
2021	FWH-80B	2
2030	FWH-125B	2
2042	FWH-150B	2
2056	FWH-200B	2
2070	FWH-250A	2
2082	FWH-250A FWH-300A *1	2
2110	FWH-250A FWH-275A *1	2
2138	FWH-300A FWH-350A *1	2
2169	FWH-350A FWH-450A *1	2
2211	FWH-450A FWH-600A *1	2
2257	FWH-600A FWH-700A *1	2
2313	FWH-800A FWH-1000A *1	2
2360	FWH-1000A	2
2415	FWH-1000A	2

\*1 Yaskawa recommends a fuse with a large rated current for applications with repeated loads.

Table 4.5 Recommended Fuse (Three-Phase 400 V Class)

Drive Model	Fuse Manufacturer: Bussmann	
	Model	Quantity
4002	FWH-50B	2
4004	FWH-50B	2
4005	FWH-50B	2
4007	FWH-60B	2
4009	FWH-60B	2
4012	FWH-60B	2
4018	FWH-80B	2
4023	FWH-90B	2
4031	FWH-150B	2
4038	FWH-200B	2
4044	FWH-200B	2
4060	FWH-225A	2
4075	FWH-250A	2
4089	FWH-275A	2
4103	FWH-275A	2
4140	FWH-300A FWH-325A *1	2
4168	FWH-400A FWH-450A *1	2
4208	FWH-500A FWH-600A *1	2
4250	FWH-600A FWH-700A *1	2
4296	FWH-700A FWH-800A *1	2
4371	FWH-800A FWH-1000A *1	2
4389	FWH-1000A FWH-1200A *1	2
4453	FWH-1200A FWH-1400A *1	2
4568	FWH-1200A FWH-1600A *1	2
4675	FWH-1600A	2

\*1 Yaskawa recommends a fuse with a large rated current for applications with repeated loads.

## ◆ EMC Directive

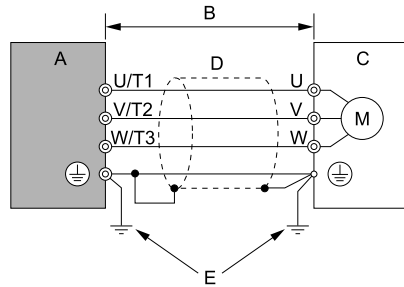
Drives with built-in EMC filters (models 2xxxB, 2xxxC, 4xxxB, 4xxxC) were tested in accordance with European standard IEC/EN 61800-3:2004/A1:2012, and comply with the EMC Directive.

Use drives with built-in EMC filters or install external EMC filters to the drive input side to comply with the EMC Directive. Refer to *Installing the External EMC Noise Filter on page 251* for the installation of the EMC filter.

**■ Install a Drive to Conform to the EMC Directive**

Install drive models 2xxxB, 2xxxC, 4xxxB, and 4xxxC with this procedure to comply with the EMC Directive when the drive is a single unit or installed in a larger device.

1. Install the drive on a grounded metal plate.
2. Wire the drive and motor.
3. Ground the wire shielding on the drive side and motor side.



- |                                    |                           |
|------------------------------------|---------------------------|
| <b>A - Drive</b>                   | <b>D - Metal conduit</b>  |
| <b>B - 10 m (32.8 ft.) maximum</b> | <b>E - Grounding wire</b> |
| <b>C - Motor</b>                   |                           |

**Figure 4.4 Wiring the Drive and Motor**

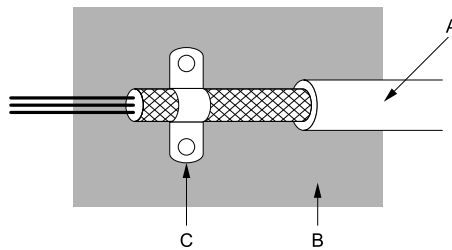
**Note:**

- Use a braided shield cable for the drive and motor wiring or put the wires through a metal conduit.
- The maximum wiring length between the drive and motor is 10 m (32.8 ft.). Keep the cable between the drive and motor as short as possible.
- Keep the grounding wire as short as possible.

4. Use a cable clamp to ground the motor cable to the metal plate.

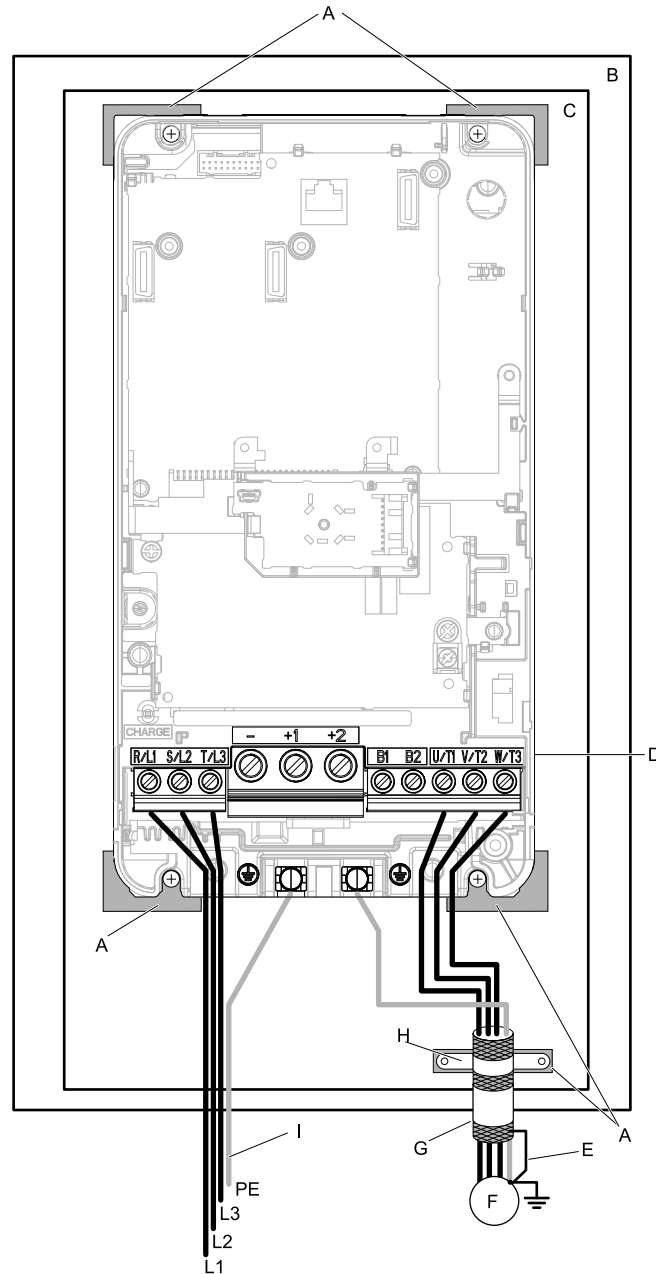
**Note:**

Make sure that the protective ground wire complies with technical specifications and local safety standards.



- |                                 |                                     |
|---------------------------------|-------------------------------------|
| <b>A - Braided shield cable</b> | <b>C - Cable clamp (conductive)</b> |
| <b>B - Metal plate</b>          |                                     |

**Figure 4.5 Ground the shield**



- |   |                           |
|---|---------------------------|
| <b>A - Grounding surface (Remove any paint or sealant.)</b> | <b>F - Motor</b>          |
| <b>B - Enclosure panel</b>                                  | <b>G - Motor cable</b>    |
| <b>C - Metal plate</b>                                      | <b>H - Cable clamp</b>    |
| <b>D - Drive</b>  | <b>I - Grounding wire</b> |
| <b>E - Shielded wire</b>                                    |                           |

**Figure 4.6 Install a Drive with a Built-in EMC Filter**

5. Connect the DC reactor to decrease harmonic distortion. Refer to [DC Reactor on page 255](#) to select a DC reactor.

**Note:**

- To maintain compliance with IEC/EN 61000-3-2 on drive models 2004, 2006, 4002, and 4004, install a DC reactor.
- The main circuit terminal block for the drive and the terminal blocks for the DC reactor come in different shapes. The drive has a European-style terminal block, and the DC reactor has a round terminal block. Correctly prepare the ends of the wiring.

**Ground Wiring**

**WARNING! Electrical Shock Hazard.** Do not remove covers or touch circuit boards while the drive is energized. Failure to obey can cause death or serious injury.

**WARNING! Electrical Shock Hazard.** Ground the neutral point on the power supply of drive models 2xxxB/C and 4xxxA/B/C to comply with the EMC Directive before turning on the EMC filter or if there is high resistance grounding. If the EMC filter is switched ON without the neutral point being grounded or if there is high resistance grounding, it can cause death or serious injury.

**Enable the Internal EMC Filter**

On drive models 2xxxB, 2xxxC, 4xxxB, and 4xxxC, move the screw or screws to turn ON and OFF (enable and disable) the EMC filter.

**WARNING! Electrical Shock Hazard.** Make sure that the power to the drive is OFF and the CHARGE LED light is OFF before you move the EMC filter screw or screws. Failure to obey could cause death or serious injury.

**WARNING! Electrical Shock Hazard.** Do not remove covers or touch circuit boards while the drive is energized. Failure to obey can cause death or serious injury.

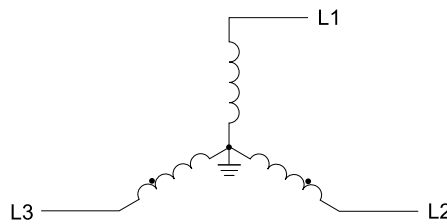
**WARNING! Electrical Shock Hazard.** Ground the neutral point on the power supply of drive models 2xxxB/C and 4xxxA/B/C to comply with the EMC Directive before turning on the EMC filter or if there is high resistance grounding. If the EMC filter is switched ON without the neutral point being grounded or if there is high resistance grounding, it can cause death or serious injury.

**WARNING! Electrical Shock Hazard.** Connect the ground cable correctly. Failure to obey can cause death or serious injury.

**NOTICE:** When disabling the internal EMC filter, move the screws from ON to OFF and then tighten to the specified torque. Completely removing the screws or tightening the screws to an incorrect torque may cause drive failure.

**NOTICE:** Move the EMC switch screw or screws to the OFF position for networks that are not symmetrically grounded. Failure to obey can cause damage to the drive.

Make sure that the symmetric grounding network is applied, and install the screw or screws in the ON position to enable the built-in EMC filter in compliance with the EMC Directive. The EMC filter switch screw or screws are installed in the OFF position by default.



**Figure 4.7 Symmetric Grounding**

**NOTICE:** When operating the drive with a non-grounding network, high resistance grounding, asymmetric grounding network, install the screw or screws in the OFF position to disable the built-in EMC filter. Failure to obey the instructions can damage the drive.

Table 4.6 shows asymmetric grounding networks.

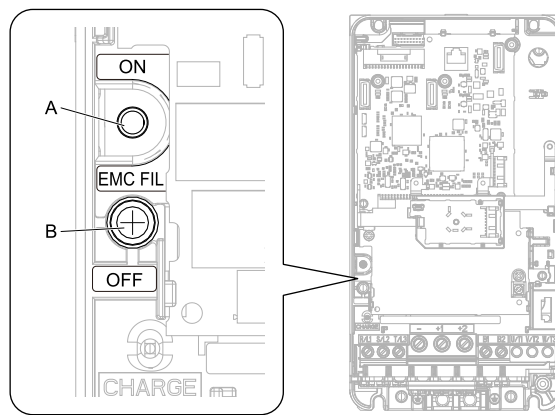
**Table 4.6 Asymmetric Grounding**

Type of Grounding	Diagram
Grounded at the corner of the delta connection	
Grounded at the middle of the side	
Single-phase, grounded at the end point	
Three-phase variable transformer without solidly grounded neutral	



**Table 4.7 EMC Filter Switch Location**

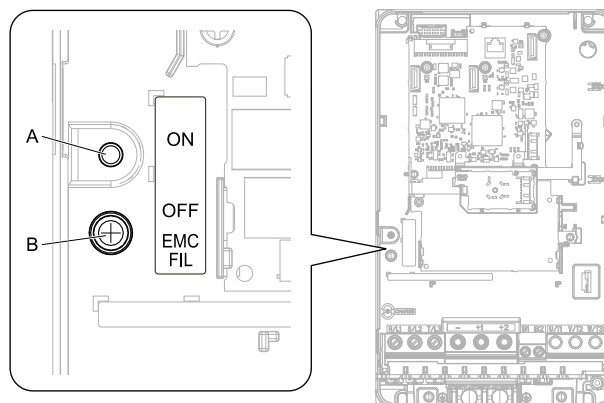
Model	Switch Location Diagram
2004B - 2042B, 4002B - 4023B 2004C - 2042C, 4002C - 4023C	Figure 4.8
2056B, 4031B, 4038B 2056C, 4031C, 4038C	Figure 4.9
2070B, 2082B, 4044B, 4060B 2070C, 2082C, 4044C, 4060C	Figure 4.10
2110B, 4075B, 2138B - 2211B, 4089B - 4168B 2110C, 4075C, 2138C - 2211C, 4089C - 4168C	Figure 4.11
2257B - 2313B, 4208B - 4296B 2257C - 2313C, 4208C - 4296C	Figure 4.12
2360B, 2415B, 4371B, 4389B 2360C, 2415C, 4371C, 4389C	Figure 4.13
4453B - 4675B 4453C - 4675C	Figure 4.14



**A - SW (ON)**

**B - Screw (OFF)**

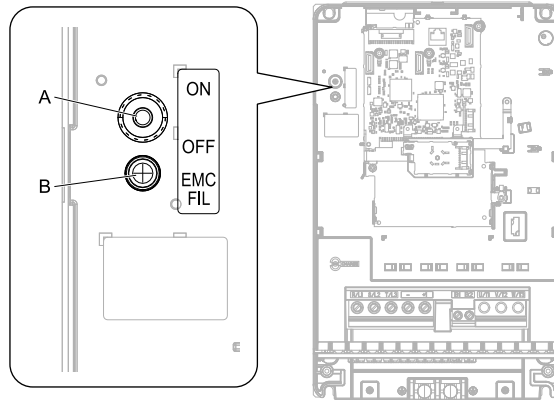
**Figure 4.8 EMC Filter Switch Location 1**



**A - SW (ON)**

**B - Screw (OFF)**

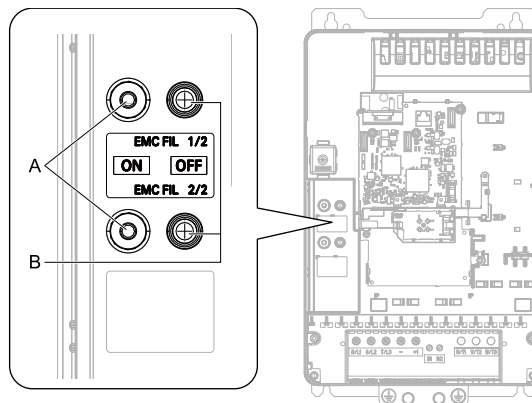
**Figure 4.9 EMC Filter Switch Location 2**



A - SW (ON)

B - Screw (OFF)

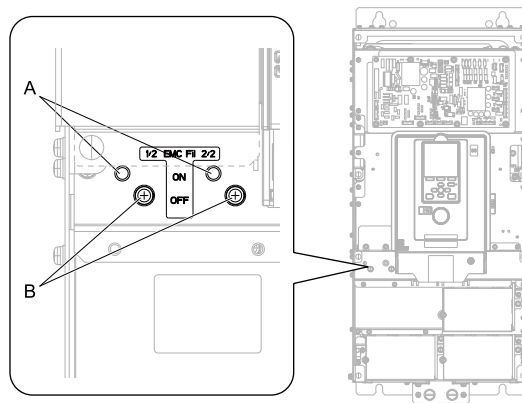
Figure 4.10 EMC Filter Switch Location 3



A - SW (ON)

B - Screw (OFF)

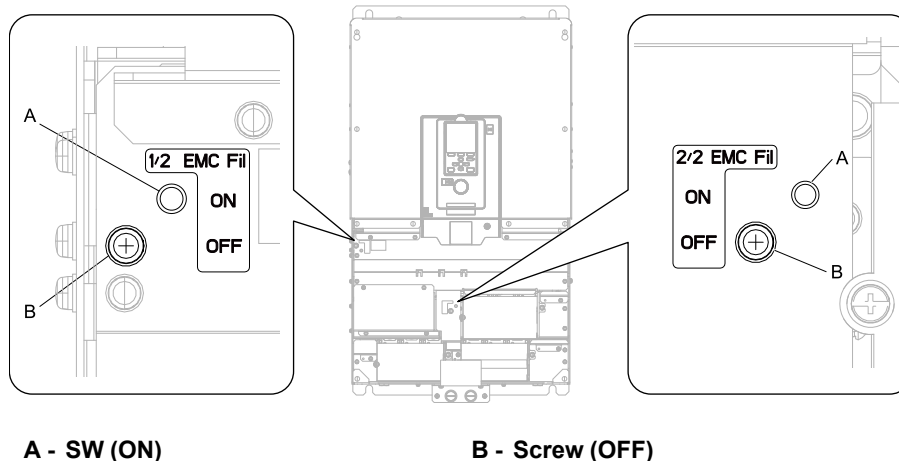
Figure 4.11 EMC Filter Switch Location 4



A - SW (ON)

B - Screw (OFF)

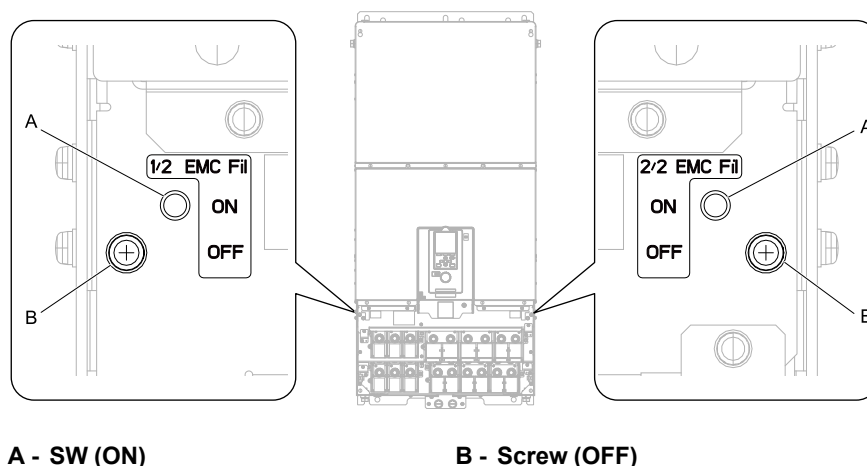
Figure 4.12 EMC Filter Switch Location 5



A - SW (ON)

B - Screw (OFF)

Figure 4.13 EMC Filter Switch Location 6



A - SW (ON)

B - Screw (OFF)

Figure 4.14 EMC Filter Switch Location 7

If you lose an EMC filter switch screw, refer to [Table 4.8](#) to find the correct replacement screw and install the new screws with the correct tightening torque.

**NOTICE:** Only use the screws specified in this manual. Failure to obey could damage the drive.

Table 4.8 Screw Sizes and Tightening Torques

Model	Screw Size	Tightening Torque N·m
2004 - 2082, 4002 - 4060	M4 × 20	1.0 - 1.3
2110 - 2211, 4075 - 4168	M4 × 25	1.0 - 1.3
2257 - 2415, 4208 - 4675	M5 × 25	2.0 - 2.5

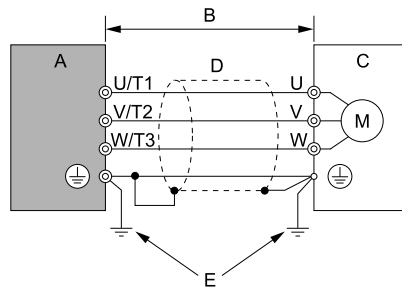
### ■ Installing the External EMC Noise Filter

Drive models 2xxxA and 4xxxA must meet conditions in this section to comply with EN 61800-3:2004+A1:2012. Connect an EMC noise filter to the input side (primary side) that complies with European standards as specified by Yaskawa. Refer to [External EMC Noise Filter Selection on page 254](#) to select the correct EMC noise filter.

Use this procedure to install an EMC noise filter to make machinery and devices added to the drive comply with the EMC Directive.

1. Install the drive and EMC noise filter on the same grounded metal plate.
2. Wire the drive and motor.

3. Ground the wire shielding on the drive side and motor side.



- A - Drive
- B - 10 m (32.8 ft.) maximum
- C - Motor
- D - Metal conduit
- E - Grounding wire

Figure 4.15 Wiring the Drive and Motor

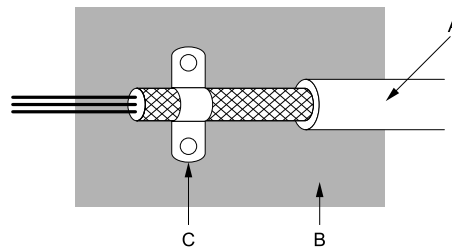
**Note:**

- Use a braided shield cable for the drive and motor wiring or put the wires through a metal conduit.
- The maximum wiring length between the drive and motor is 10 m (32.8 ft.). Keep the cable between the drive and motor as short as possible.
- Keep the grounding wire as short as possible.

4. Use a cable clamp to ground the motor cable to the metal plate.

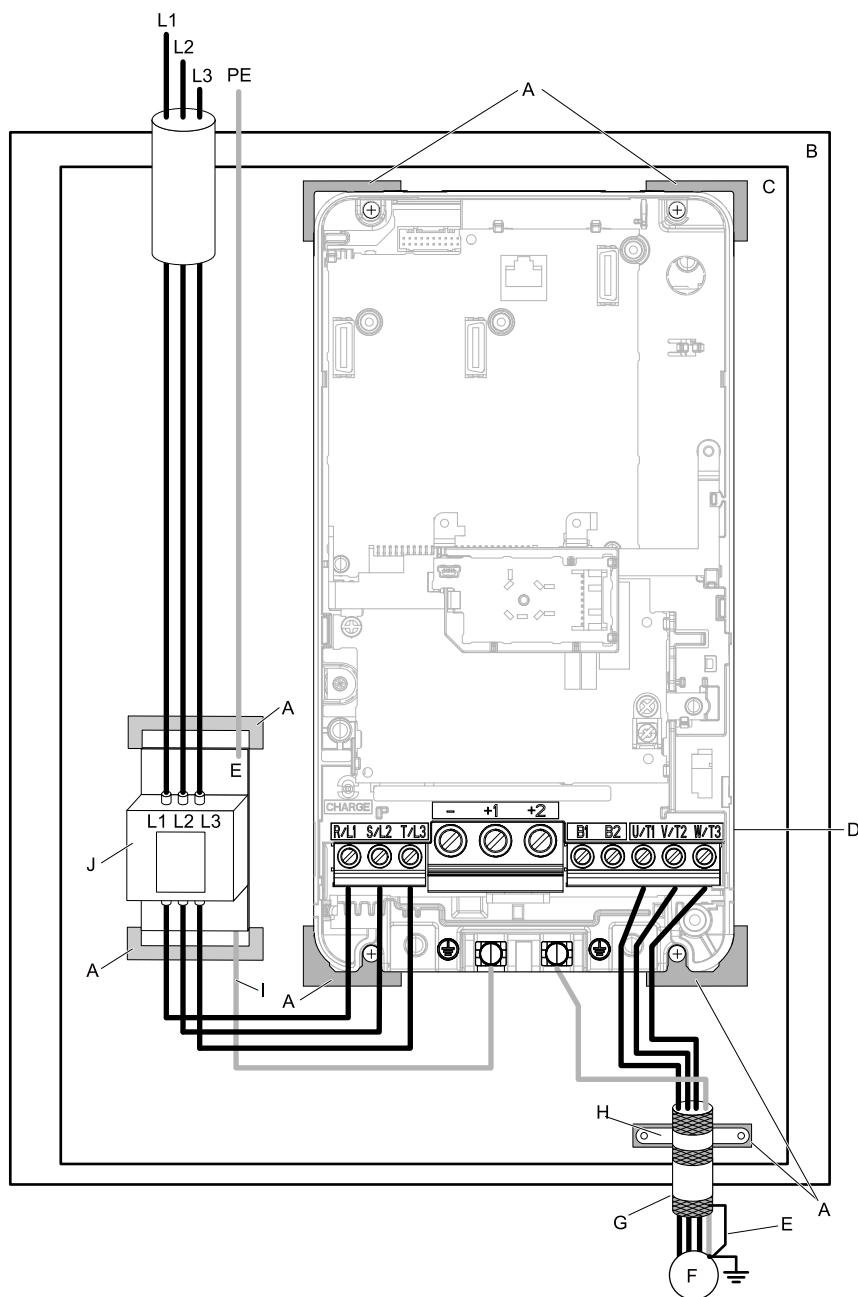
**Note:**

Make sure that the protective ground wire complies with technical specifications and local safety standards.



- A - Braided shield cable
- B - Metal plate
- C - Cable clamp (conductive)

Figure 4.16 Ground the Shield



- |   |   |
|---|---|
| <b>A</b> - Grounding surface (Remove any paint or sealant.) | <b>F</b> - Motor  |
| <b>B</b> - Enclosure panel                                  | <b>G</b> - Motor cable (Braided shield cable: max. 10 m (32.8 ft.)) |
| <b>C</b> - Metal plate                                      | <b>H</b> - Cable clamp  |
| <b>D</b> - Drive  | <b>I</b> - Grounding wire   |
| <b>E</b> - Ground the shield.                               | <b>J</b> - EMC noise filter   |

**Figure 4.17 EMC Noise Filter and Drive Installation Procedure**

5. Connect the DC reactor to decrease harmonic distortion. Refer to [DC Reactor on page 255](#) to select a DC reactor.

**Note:**

- To maintain compliance with IEC/EN 61000-3-2 on drive models 2004, 2006, 4002, and 4004, install a DC reactor.
- The main circuit terminal block for the drive, and the terminal blocks for the DC reactor come in different shapes. The drive has a European style terminal block, and the DC reactor has a round terminal block. Correctly prepare the ends of the wiring.

**Ground Wiring**

**WARNING!** *Electrical Shock Hazard. Do not remove covers or touch circuit boards while the drive is energized. Failure to obey can cause death or serious injury.*

## 4.2 European Standards

**WARNING! Electrical Shock Hazard.** Ground the neutral point on the power supply of drive models 2xxxB/C and 4xxxA/B/C to comply with the EMC Directive before turning on the EMC filter or if there is high resistance grounding. If the EMC filter is switched ON without the neutral point being grounded or if there is high resistance grounding, it can cause death or serious injury.

### External EMC Noise Filter Selection

**Table 4.9 External EMC Noise Filter (2xxxA)**

Model	EMC Noise Filter Model	Quantity	Manufacturer
2004A	RTEN-5006	1	TDK
2006A	RTEN-5010	1	TDK
2010A	RTEN-5020	1	TDK
2012A	RTEN-5020	1	TDK
2018A	RTEN-5030	1	TDK
2021A	RTEN-5030	1	TDK
2030A	RTEN-5060	1	TDK
2042A	RTEN-5060	1	TDK
2056A	RTEN-5080	1	TDK
2070A	FS5972-100-35	1	Schaffner
2082A	FS5972-100-35	1	Schaffner
2110A	FS5972-170-40	1	Schaffner
2138A	FS5972-170-40	1	Schaffner
2169A	FS5972-170-40	1	Schaffner
2211A	FS5972-250-37	1	Schaffner
2257A	FS5972-410-99	1	Schaffner
2313A	FS5972-410-99	1	Schaffner
2360A	FS5972-410-99	1	Schaffner
2415A	FS5972-600-99	1	Schaffner

**Table 4.10 External EMC Noise Filter (4xxxA)**

Model	EMC Noise Filter Model	Quantity	Manufacturer
4002A	B84143A0010R106	1	TDK
4004A	B84143A0010R106	1	TDK
4005A	B84143A0010R106	1	TDK
4007A	B84143A0010R106	1	TDK
4009A	B84143A0020R106	1	TDK
4012A	B84143A0020R106	1	TDK
4018A	B84143A0035R106	1	TDK
4023A	B84143A0035R106	1	TDK
4031A	B84143A0050R106	1	TDK
4038A	B84143A0065R106	1	TDK
4044A	B84143A0065R106	1	TDK
4060A	B84143A0065R106	1	TDK
4075A	B84143A0080R106	1	TDK
4089A	FS5972-100-35	1	Schaffner
4103A	FS5972-170-40	1	Schaffner
4140A	FS5972-170-40	1	Schaffner
4168A	FS5972-170-40	1	Schaffner
4208A	FS5972-250-37	1	Schaffner

Model	EMC Noise Filter Model	Quantity	Manufacturer
4250A	FS5972-250-37	1	Schaffner
4296A	FS5972-410-99	1	Schaffner
4371A	FS5972-410-99	1	Schaffner
4389A	FS5972-410-99	1	Schaffner
4453A	FS5972-600-99	1	Schaffner
4568A	FS5972-600-99	1	Schaffner
4675A	FS5972-410-99	2	Schaffner

## ■ DC Reactor

To comply with IEC/EN 61000-3-2, install a DC reactor to drive models 2004, 2006, 4002, and 4004 when using an internal or external EMC filter. Refer to [Table 4.11](#) to select the correct DC reactor.

**Table 4.11 DC Reactors for Harmonic Suppression (Manufacturer: Yaskawa Electric)**

Drive Model	DC Reactor Model	DC Reactor Rating
2004	UZDA-B	5.4 A, 8 mH
2006	UZDA-B	5.4 A, 8 mH
4002	UZDA-B	3.2 A, 28 mH
4004	UZDA-B	3.2 A, 28 mH

## 4.3 UL Standards



Figure 4.18 UL/cUL Mark

The UL/cUL Mark indicates that this product satisfies stringent safety standards. This mark appears on products in the United States and Canada. It shows UL approval, indicating that it has been determined that the product complies with safety standards after undergoing strict inspection and assessment. UL-approved parts must be used for all major components that are built into electrical appliances that obtain UL approval.

This product has been tested in accordance with UL standard UL61800-5-1, and has been verified to be in compliance with UL standards.

Machines and devices integrated with this product must satisfy the following conditions for compliance with UL standards.

### ◆ Area of Use

Install this product in a location with overvoltage category III and pollution degree 2 or less. These standards are specified in IEC/EN 60664.

### ■ Ambient Temperature

Maintain the ambient temperature within the following ranges according to the enclosure type.

- Enclosed wall-mounted type (UL Type 1): -10 °C to +40 °C (14 °F to 104 °F)
- Open chassis type (IP20): -10 °C to +50 °C (14 °F to 122 °F)

### ◆ Wire the Main Circuit Terminal Block

Wire the main circuit terminal block correctly as specified by the instructions in the manual.

To comply with UL standards on drive models 2257 to 2415 and 4208 to 4675, use UL-approved closed-loop crimp terminals. Use the tools recommend by the terminal manufacturer to crimp the closed-loop crimp terminal. Refer to [Closed-Loop Crimp Terminals on page 270](#) for more information about closed-loop crimp terminals (UL-compliant products).

To select the correct wire gauge, refer to [Three-Phase 200 V Class on page 259](#) and [Three-Phase 400 V Class on page 264](#).

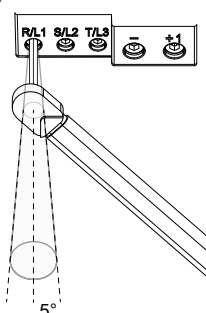
### ■ Notes on Wiring the Main Circuit Terminal Block

Read these notes before you wire the main circuit terminal block.

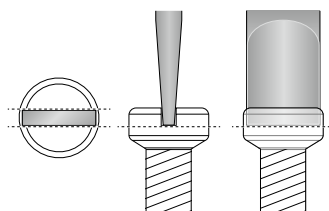


**Note:**

- Use UL-Listed, vinyl-coated insulated copper wires for operation with a continuous maximum permitted temperature of 75 °C at 600 V
- Remove all unwanted objects that are near the terminal block connections.
- Remove the insulation from the connection wires to the wire stripping lengths shown in the manual.
- Do not use bent or crushed wires. Remove the damaged end of the wire before you use it. Incorrect connections can cause death or serious injury from fire.
- Do not solder stranded wire. Soldered wire connections can become loose over time and cause unsatisfactory drive performance.
- If you use stranded wire, make sure that all of the wire strands are in the connection. Also, do not twist the stranded wire too much. Incorrect connections can cause death or serious injury from fire.
- Put the wire all the way into the terminal block. Remove the insulation from the wire to the recommended wire stripping length to fit the wire with insulation in the plastic housing.
- Use a torque driver, torque ratchet, or torque wrench for the screws. A slotted driver or a hex tool will be necessary to wire the screw clamp terminal. Use applicable tools as specified by the recommended conditions in the product manual.
- If you use power tools to tighten the terminal screws, use a low speed setting (300 to 400 r/min). Failure to obey can cause damage to the terminal screws.
- Users can purchase wiring tools from Yaskawa. Contact Yaskawa or your nearest sales representative for more information.
- Wire gauges on existing drive models to be replaced may not match wire gauge ranges on new drives. Contact Yaskawa or your nearest sales representative for wire gauges that you can and cannot use.
- Do not tighten the terminal screws at an angle of 5 degrees or more. Failure to obey can cause damage to the terminal screws.

**Figure 4.19 Permitted Angle**

- Put the bit all the way into the hex socket to tighten the hex socket cap screw.
- When tightening slotted screws, hold the straight-edge screwdriver perpendicularly to the screw. Do not allow the tip of the screwdriver to shift or protrude from the groove of the screw.

**Figure 4.20 Tightening Slotted Screws**

- After connecting the wires to the terminal block, lightly pull on the wires to make sure that they do not come out of the terminals.
- Remove the correct section of the wiring cover to make wiring easier.
- Do not let strain on the wiring cause damage. Use a strain relief near the wiring to release the tension. Refer to [Figure 4.21](#) for an example.

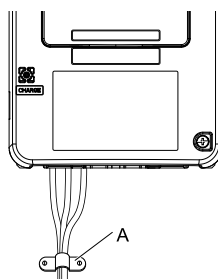
**A - Strain relief****Figure 4.21 Strain Relief Example**

Table 4.12 Recommended Wiring Tools

Screw Size	Screw Shape	Adapter	Bit		Torque Driver Model (Tightening Torque)	Torque Wrench
			Model	Manufacturer		
M4	Slotted (-)	Bit	SF-BIT-SL 1,0X4,0-70	PHOENIX CONTACT	TSD-M 3NM (1.2 - 3 N·m)	-
M5 *1	Slotted (-)	Bit	SF-BIT-SL 1,2X6,5-70	PHOENIX CONTACT	Wire Gauge ≤ 25 mm <sup>2</sup> (AWG 10): TSD-M 3NM (1.2 - 3 N·m)	Wire Gauge ≤ 25 mm <sup>2</sup> (AWG 10): -
					Wire Gauge ≥ 30 mm <sup>2</sup> (AWG 8): -	Wire Gauge ≥ 30 mm <sup>2</sup> (AWG 8): 4.1 - 4.5 N·m *2 *3
M6	Hex socket cap (WAF: 5 mm)	Bit	SF-BIT-HEX 5-50	PHOENIX CONTACT	-	5 - 9 N·m *2 *3
	Slotted (-)	Bit	SF-BIT-SL 1,2X6,5-70	PHOENIX CONTACT	-	3 - 3.5 N·m *2 *3
M8	Hex socket cap (WAF: 6 mm)	Bit	SF-BIT-HEX 6-50	PHOENIX CONTACT	-	8 - 12 N·m *2 *3
M10	Hex socket cap (WAF: 8 mm)	Bit	SF-BIT-HEX 8-50	PHOENIX CONTACT	-	12 - 14 N·m *2 *3

\*1 When wiring drive models 2056 and 4089 and smaller, select the correct tools for the wire gauge.

\*2 Use 6.35 mm (0.25 in) bit socket holder.

\*3 Use a torque wrench that can apply this torque measurement range.

## ■ Main Circuit Wire Gauges and Tightening Torques

Refer to *Three-Phase 200 V Class on page 259* and *Three-Phase 400 V Class on page 264* for the recommended wire gauges and tightening torques of the main circuit terminals.

Comply with local standards for correct wire gauges in the region where the drive is used.

**WARNING! Electrical Shock Hazard.** Only connect peripheral options, for example a DC reactor or braking resistor, to terminals +1, +2, +3, -, B1, and B2. Failure to obey can cause death or serious injury.

### Note:

- The recommended wire gauges are based on drive continuous current ratings with 75 °C (167 °F) 600 V class 2 heat-resistant indoor PVC wire. Assume these conditions:
  - Ambient temperature: 40 °C (104 °F) or lower
  - Wiring distance: 100 m (3281 ft.) or shorter
  - Normal Duty Rated current value
- Refer to the instruction manual for each device for recommended wire gauges to connect peripheral devices or options to terminals +1, +2, +3, -, B1, and B2. Contact Yaskawa or your nearest sales representative if the recommended wire gauges for the peripheral devices or options are out of the range of the applicable gauges for the drive.
- 2257 to 2415 and 4208 to 4675, use UL-approved closed-loop crimp terminals on the drive main circuit terminals. Use the tools recommend by the terminal manufacturer and make sure that the terminals are correctly connected.

## Three-Phase 200 V Class

Model	Terminals	Recommended Gauge AWG, kcmil	Applicable Gauge (IP20 Applicable Gauge *) AWG, kcmil	Wire Stripping Length *2 mm	Terminal Screw		Tightening Torque N·m (lb·in.)
					Size	Shape	
2004	R/L1, S/L2, T/L3	14	14 - 6 (14 - 6)	10	M4	Slotted (-)	1.5 - 1.7 (13.5 - 15)
	U/T1, V/T2, W/T3	14	14 - 6 (14 - 6)	10	M4	Slotted (-)	1.5 - 1.7 (13.5 - 15)
	-, +1, +2	14	14 - 3 (14 - 3)	18	M5	Slotted (-)	2.3 - 2.5 (19.8 - 22) *3
	B1, B2	14	14 - 10 (14 - 10)	10	M4	Slotted (-)	1.5 - 1.7 (13.5 - 15)
	⊕	10	14 - 8 (-)	-	M4	Phillips/slotted combo	1.2 - 1.5 (10.6 - 13.3)
2006	R/L1, S/L2, T/L3	14	14 - 6 (14 - 6)	10	M4	Slotted (-)	1.5 - 1.7 (13.5 - 15)
	U/T1, V/T2, W/T3	14	14 - 6 (14 - 6)	10	M4	Slotted (-)	1.5 - 1.7 (13.5 - 15)
	-, +1, +2	14	14 - 3 (14 - 3)	18	M5	Slotted (-)	2.3 - 2.5 (19.8 - 22) *3
	B1, B2	14	14 - 10 (14 - 10)	10	M4	Slotted (-)	1.5 - 1.7 (13.5 - 15)
	⊕	10	14 - 8 (-)	-	M4	Phillips/slotted combo	1.2 - 1.5 (10.6 - 13.3)
2010	R/L1, S/L2, T/L3	12	14 - 6 (14 - 6)	10	M4	Slotted (-)	1.5 - 1.7 (13.5 - 15)
	U/T1, V/T2, W/T3	14	14 - 6 (14 - 6)	10	M4	Slotted (-)	1.5 - 1.7 (13.5 - 15)
	-, +1, +2	12	14 - 3 (14 - 3)	18	M5	Slotted (-)	2.3 - 2.5 (19.8 - 22) *3
	B1, B2	14	14 - 10 (14 - 10)	10	M4	Slotted (-)	1.5 - 1.7 (13.5 - 15)
	⊕	10	14 - 8 (-)	-	M4	Phillips/slotted combo	1.2 - 1.5 (10.6 - 13.3)
2012	R/L1, S/L2, T/L3	10	14 - 6 (14 - 6)	10	M4	Slotted (-)	1.5 - 1.7 (13.5 - 15)
	U/T1, V/T2, W/T3	12	14 - 6 (14 - 6)	10	M4	Slotted (-)	1.5 - 1.7 (13.5 - 15)
	-, +1, +2	10	14 - 3 (14 - 3)	18	M5	Slotted (-)	2.3 - 2.5 (19.8 - 22) *3
	B1, B2	14	14 - 10 (14 - 10)	10	M4	Slotted (-)	1.5 - 1.7 (13.5 - 15)
	⊕	10	14 - 8 (-)	-	M4	Phillips/slotted combo	1.2 - 1.5 (10.6 - 13.3)

### 4.3 UL Standards

Model	Terminals	Recommended Gauge AWG, kcmil	Applicable Gauge (IP20 Applicable Gauge *) AWG, kcmil	Wire Stripping Length *2 mm	Terminal Screw		Tightening Torque N·m (lb·in.)
					Size	Shape	
2018	R/L1, S/L2, T/L3	10	14 - 6 (14 - 6)	10	M4	Slotted (-)	1.5 - 1.7 (13.5 - 15)
	U/T1, V/T2, W/T3	10	14 - 6 (14 - 6)	10	M4	Slotted (-)	1.5 - 1.7 (13.5 - 15)
	-, +1, +2	8	14 - 3 (14 - 3)	18	M5	Slotted (-)	2.3 - 2.5 (19.8 - 22) *3
	B1, B2	14	14 - 10 (14 - 10)	10	M4	Slotted (-)	1.5 - 1.7 (13.5 - 15)
	⊕	10	14 - 8 (-)	-	M4	Phillips/slotted combo	1.2 - 1.5 (10.6 - 13.3)
2021	R/L1, S/L2, T/L3	8	14 - 6 (14 - 6)	10	M4	Slotted (-)	1.5 - 1.7 (13.5 - 15)
	U/T1, V/T2, W/T3	10	14 - 6 (14 - 6)	10	M4	Slotted (-)	1.5 - 1.7 (13.5 - 15)
	-, +1, +2	8	14 - 3 (14 - 3)	18	M5	Slotted (-)	2.3 - 2.5 (19.8 - 22) *3
	B1, B2	14	14 - 10 (14 - 10)	10	M4	Slotted (-)	1.5 - 1.7 (13.5 - 15)
	⊕	10	12 - 8 (-)	-	M4	Phillips/slotted combo	1.2 - 1.5 (10.6 - 13.3)
2030	R/L1, S/L2, T/L3	6	14 - 6 (14 - 6)	10	M4	Slotted (-)	1.5 - 1.7 (13.5 - 15)
	U/T1, V/T2, W/T3	8	14 - 6 (14 - 6)	10	M4	Slotted (-)	1.5 - 1.7 (13.5 - 15)
	-, +1, +2	6	14 - 3 (14 - 3)	18	M5	Slotted (-)	2.3 - 2.5 (19.8 - 22) *3
	B1, B2	12	14 - 10 (14 - 10)	10	M4	Slotted (-)	1.5 - 1.7 (13.5 - 15)
	⊕	8	10 - 8 (-)	-	M5	Phillips/slotted combo	2.0 - 2.5 (17.7 - 22.1)
2042	R/L1, S/L2, T/L3	6	14 - 6 (14 - 6)	10	M4	Slotted (-)	1.5 - 1.7 (13.5 - 15)
	U/T1, V/T2, W/T3	6	14 - 6 (14 - 6)	10	M4	Slotted (-)	1.5 - 1.7 (13.5 - 15)
	-, +1, +2	3	14 - 3 (14 - 3)	18	M5	Slotted (-)	2.3 - 2.5 (19.8 - 22) *3
	B1, B2	10	14 - 10 (14 - 10)	10	M4	Slotted (-)	1.5 - 1.7 (13.5 - 15)
	⊕	8	10 - 8 (-)	-	M5	Phillips/slotted combo	2.0 - 2.5 (17.7 - 22.1)

Model	Terminals	Recommended Gauge AWG, kcmil	Applicable Gauge (IP20 Applicable Gauge *) AWG, kcmil	Wire Stripping Length *2 mm	Terminal Screw		Tightening Torque N·m (lb·in.)
					Size	Shape	
2056	R/L1, S/L2, T/L3	3	14 - 3 (8 - 3)	18	M5	Slotted (-)	2.3 - 2.5 (19.8 - 22) *3
	U/T1, V/T2, W/T3	4	14 - 4 (10 - 4)	18	M5	Slotted (-)	2.3 - 2.5 (19.8 - 22) *3
	-, +1, +2	1	14 - 1 (8 - 1)	20	M6	Hex socket cap (WAF: 5 mm)	5 - 5.5 (45 - 49)
	B1, B2	8	14 - 8 (14 - 8)	10	M4	Slotted (-)	1.5 - 1.7 (13.5 - 15)
	⊕	6	8 - 6 (-)	-	M6	Phillips/slotted combo	5.4 - 6.0 (47.8 - 53.1)
2070	R/L1, S/L2, T/L3	1	14 - 1 (6 - 1)	20	M6	Hex socket cap (WAF: 5 mm)	5 - 5.5 (45 - 49)
	U/T1, V/T2, W/T3	3	14 - 3 (6 - 3)	20	M6	Hex socket cap (WAF: 5 mm)	5 - 5.5 (45 - 49)
	-, +1, +2	1/0	14 - 1/0 (4 - 1/0)	20	M6	Hex socket cap (WAF: 5 mm)	5 - 5.5 (45 - 49)
	B1, B2	8	14 - 8 (14 - 8)	10	M4	Slotted (-)	1.5 - 1.7 (13.5 - 15)
	⊕	6	6 - 4 (-)	-	M6	Phillips/slotted combo	5.4 - 6.0 (47.8 - 53.1)
2082	R/L1, S/L2, T/L3	1/0	14 - 1/0 (6 - 1/0)	20	M6	Hex socket cap (WAF: 5 mm)	5 - 5.5 (45 - 49)
	U/T1, V/T2, W/T3	2	14 - 2 (6 - 2)	20	M6	Hex socket cap (WAF: 5 mm)	5 - 5.5 (45 - 49)
	-, +1, +2	2/0	14 - 2/0 (4 - 2/0)	20	M6	Hex socket cap (WAF: 5 mm)	5 - 5.5 (45 - 49)
	B1, B2	6	14 - 6 (14 - 6)	10	M4	Slotted (-)	1.5 - 1.7 (13.5 - 15)
	⊕	6	6 - 4 (-)	-	M6	Phillips/slotted combo	5.4 - 6.0 (47.8 - 53.1)
2110	R/L1, S/L2, T/L3	1/0	6 - 1/0 (6 - 1/0)	27	M6	Hex socket cap (WAF: 5 mm)	8 - 9 (71 - 80)
	U/T1, V/T2, W/T3	1/0	6 - 1/0 (6 - 1/0)	27	M6	Hex socket cap (WAF: 5 mm)	8 - 9 (71 - 80)
	-, +1	2/0	2 - 2/0 (2 - 2/0)	27	M8	Hex socket cap (WAF: 6 mm)	10 - 12 (89 - 107)
	B1, B2	4	14 - 4 (10 - 4)	21	M6	Minus (-)	3 - 3.5 (27 - 31)
	⊕	6	6 - 4 (-)	-	M6	Hex bolt (+)	5.4 - 6.0 (47.8 - 53.1)

### 4.3 UL Standards

Model	Terminals	Recommended Gauge AWG, kcmil	Applicable Gauge (IP20 Applicable Gauge *) AWG, kcmil	Wire Stripping Length *2 mm	Terminal Screw		Tightening Torque N·m (lb·in.)
					Size	Shape	
2138	R/L1, S/L2, T/L3	2/0	6 - 2/0 (2 - 2/0)	27	M6	Hex socket cap (WAF: 5 mm)	8 - 9 (71 - 80)
	U/T1, V/T2, W/T3	2/0	6 - 2/0 (2 - 2/0)	27	M6	Hex socket cap (WAF: 5 mm)	8 - 9 (71 - 80)
	-, +1	4/0	2 - 4/0 (2 - 4/0)	27	M8	Hex socket cap (WAF: 6 mm)	10 - 12 (89 - 107)
	B1, B2	3	14 - 3 (10 - 3)	21	M6	Minus (-)	3 - 3.5 (27 - 31)
	⊕	4	4 (-)	-	M6	Hex bolt (+)	5.4 - 6.0 (47.8 - 53.1)
2169	R/L1, S/L2, T/L3	4/0	2 - 250 (2/0 - 250)	37	M10	Hex socket cap (WAF: 8 mm)	12 - 14 (107 - 124)
	U/T1, V/T2, W/T3	4/0	2 - 300 (3/0 - 300)	37	M10	Hex socket cap (WAF: 8 mm)	12 - 14 (107 - 124)
	-, -, +1, +1 *4 *5	1	6 - 2/0 (1/0 - 2/0)	28	M6	Hex socket cap (WAF: 5 mm)	8 - 9 (71 - 80)
	+3 *5	1/0	4 - 2/0 (1 - 2/0)	28	M8	Hex socket cap (WAF: 6 mm)	8 - 9 (71 - 80)
	⊕	4	4 - 1/0 (-)	-	M8	Hex bolt (slotted)	9.0 - 11 (79.7 - 97.4)
2211	R/L1, S/L2, T/L3	250	2 - 250 (2/0 - 250)	37	M10	Hex socket cap (WAF: 8 mm)	12 - 14 (107 - 124)
	U/T1, V/T2, W/T3	300	2 - 300 (3/0 - 300)	37	M10	Hex socket cap (WAF: 8 mm)	12 - 14 (107 - 124)
	-, -, +1, +1 *4 *5	2/0	6 - 2/0 (1/0 - 2/0)	28	M6	Hex socket cap (WAF: 5 mm)	8 - 9 (71 - 80)
	+3 *5	2/0	4 - 2/0 (1 - 2/0)	28	M8	Hex socket cap (WAF: 6 mm)	8 - 9 (71 - 80)
	⊕	4	4 - 1/0 (-)	-	M8	Hex bolt (slotted)	9.0 - 11 (79.7 - 97.4)
2257	R/L1, S/L2, T/L3	2/0 × 2P	3 - 4/0 × 2P (2/0 - 4/0 × 2P)	-	M10	Hex self-locking nut	20 (177)
	U/T1, V/T2, W/T3	2/0 × 2P	3 - 4/0 × 2P (2/0 - 4/0 × 2P)	-	M10	Hex self-locking nut	20 (177)
	-, +1	4/0 × 2P	2 - 250 × 2P (4/0 - 250 × 2P)	-	M10	Hex self-locking nut	20 (177)
	+3	1/0 × 2P	4 - 1/0 × 2P (1/0 × 2P)	-	M10	Hex self-locking nut	20 (177)
	⊕	3	3 - 350 (-)	-	M10	Hex bolt (slotted)	18 - 23 (159 - 204)

Model	Terminals	Recommended Gauge AWG, kcmil	Applicable Gauge (IP20 Applicable Gauge *) AWG, kcmil	Wire Stripping Length *2 mm	Terminal Screw		Tightening Torque N·m (lb·in.)
					Size	Shape	
2313	R/L1, S/L2, T/L3	4/0 × 2P	3 - 4/0 × 2P (2/0 - 4/0 × 2P)	-	M10	Hex self-locking nut	20 (177)
	U/T1, V/T2, W/T3	3/0 × 2P	3 - 4/0 × 2P (2/0 - 4/0 × 2P)	-	M10	Hex self-locking nut	20 (177)
	-, +1	250 × 2P	2 - 250 × 2P (4/0 - 250 × 2P)	-	M10	Hex self-locking nut	20 (177)
	+3	1/0 × 2P	4 - 1/0 × 2P (1/0 × 2P)	-	M10	Hex self-locking nut	20 (177)
	⊕	2	2 - 350 (-)	-	M10	Hex bolt (slotted)	18 - 23 (159 - 204)
2360	R/L1, S/L2, T/L3	250 × 2P	2/0 - 300 × 2P (250 - 300 × 2P)	-	M12	Hex self-locking nut	35 (310)
	U/T1, V/T2, W/T3	250 × 2P	2/0 - 300 × 2P (250 - 300 × 2P)	-	M12	Hex self-locking nut	35 (310)
	-, +1	350 × 2P	4/0 - 400 × 2P (300 - 400 × 2P)	-	M12	Hex self-locking nut	35 (310)
	+3	3/0 × 2P	1/0 - 4/0 × 2P (-)	-	M12	Hex self-locking nut	35 (310)
	⊕	1	1 - 350 (-)	-	M12	Hex bolt (slotted)	32 - 40 (283 - 354)
2415	R/L1, S/L2, T/L3	250 × 2P	2/0 - 300 × 2P (250 - 300 × 2P)	-	M12	Hex self-locking nut	35 (310)
	U/T1, V/T2, W/T3	300 × 2P	2/0 - 300 × 2P (250 - 300 × 2P)	-	M12	Hex self-locking nut	35 (310)
	-, +1	350 × 2P	4/0 - 400 × 2P (300 - 400 × 2P)	-	M12	Hex self-locking nut	35 (310)
	+3	3/0 × 2P	1/0 - 4/0 × 2P (-)	-	M12	Hex self-locking nut	35 (310)
	⊕	1	1 - 350 (-)	-	M12	Hex bolt (slotted)	32 - 40 (283 - 354)

\*1 For IP20 protection, use wires that are in the range of applicable gauges.

\*2 Remove insulation from the ends of wires to expose the length of wire shown.

\*3 For wire gauges more than AWG 8, tighten to a tightening torque of 4.1 N·m to 4.5 N·m (36 lb·in. to 40 lb·in.).

\*4 Terminals - and +1 have two screws. The Recommended Gauge is the wire gauge for one terminal.

\*5 A junction terminal is necessary to connect a braking unit (CDBR-series) to terminals - and +3.

### 4.3 UL Standards

#### Three-Phase 400 V Class

Model	Terminals	Recommended Gauge AWG, kcmil	Applicable Gauge (IP20 Applicable Gauge *) AWG, kcmil	Wire Stripping Length *2 mm	Terminal Screw		Tightening Torque N·m (lb·in.)
					Size	Shape	
4002	R/L1, S/L2, T/L3	14	14 - 6 (14 - 6)	10	M4	Slotted (-)	1.5 - 1.7 (13.5 - 15)
	U/T1, V/T2, W/T3	14	14 - 6 (14 - 6)	10	M4	Slotted (-)	1.5 - 1.7 (13.5 - 15)
	-, +1, +2	14	14 - 3 (14 - 3)	18	M5	Slotted (-)	2.3 - 2.5 (19.8 - 22) *3
	B1, B2	14	14 - 10 (14 - 10)	10	M4	Slotted (-)	1.5 - 1.7 (13.5 - 15)
	⊕	12	14 - 8 (-)	-	M4	Phillips/slotted combo	1.2 - 1.5 (10.6 - 13.3)
4004	R/L1, S/L2, T/L3	14	14 - 6 (14 - 6)	10	M4	Slotted (-)	1.5 - 1.7 (13.5 - 15)
	U/T1, V/T2, W/T3	14	14 - 6 (14 - 6)	10	M4	Slotted (-)	1.5 - 1.7 (13.5 - 15)
	-, +1, +2	14	14 - 3 (14 - 3)	18	M5	Slotted (-)	2.3 - 2.5 (19.8 - 22) *3
	B1, B2	14	14 - 10 (14 - 10)	10	M4	Slotted (-)	1.5 - 1.7 (13.5 - 15)
	⊕	12	14 - 8 (-)	-	M4	Phillips/slotted combo	1.2 - 1.5 (10.6 - 13.3)
4005	R/L1, S/L2, T/L3	14	14 - 6 (14 - 6)	10	M4	Slotted (-)	1.5 - 1.7 (13.5 - 15)
	U/T1, V/T2, W/T3	14	14 - 6 (14 - 6)	10	M4	Slotted (-)	1.5 - 1.7 (13.5 - 15)
	-, +1, +2	14	14 - 3 (14 - 3)	18	M5	Slotted (-)	2.3 - 2.5 (19.8 - 22) *3
	B1, B2	14	14 - 10 (14 - 10)	10	M4	Slotted (-)	1.5 - 1.7 (13.5 - 15)
	⊕	10	14 - 8 (-)	-	M4	Phillips/slotted combo	1.2 - 1.5 (10.6 - 13.3)
4007	R/L1, S/L2, T/L3	14	14 - 6 (14 - 6)	10	M4	Slotted (-)	1.5 - 1.7 (13.5 - 15)
	U/T1, V/T2, W/T3	14	14 - 6 (14 - 6)	10	M4	Slotted (-)	1.5 - 1.7 (13.5 - 15)
	-, +1, +2	14	14 - 3 (14 - 3)	18	M5	Slotted (-)	2.3 - 2.5 (19.8 - 22) *3
	B1, B2	14	14 - 10 (14 - 10)	10	M4	Slotted (-)	1.5 - 1.7 (13.5 - 15)
	⊕	10	14 - 8 (-)	-	M4	Phillips/slotted combo	1.2 - 1.5 (10.6 - 13.3)



Model	Terminals	Recommended Gauge AWG, kcmil	Applicable Gauge (IP20 Applicable Gauge *) AWG, kcmil	Wire Stripping Length *2 mm	Terminal Screw		Tightening Torque N·m (lb·in.)
					Size	Shape	
4009	R/L1, S/L2, T/L3	14	14 - 6 (14 - 6)	10	M4	Slotted (-)	1.5 - 1.7 (13.5 - 15)
	U/T1, V/T2, W/T3	14	14 - 6 (14 - 6)	10	M4	Slotted (-)	1.5 - 1.7 (13.5 - 15)
	-, +1, +2	12	14 - 3 (14 - 3)	18	M5	Slotted (-)	2.3 - 2.5 (19.8 - 22) *3
	B1, B2	14	14 - 10 (14 - 10)	10	M4	Slotted (-)	1.5 - 1.7 (13.5 - 15)
	⊕	10	14 - 8 (-)	-	M4	Phillips/slotted combo	1.2 - 1.5 (10.6 - 13.3)
4012	R/L1, S/L2, T/L3	12	14 - 6 (14 - 6)	10	M4	Slotted (-)	1.5 - 1.7 (13.5 - 15)
	U/T1, V/T2, W/T3	14	14 - 6 (14 - 6)	10	M4	Slotted (-)	1.5 - 1.7 (13.5 - 15)
	-, +1, +2	10	14 - 3 (14 - 3)	18	M5	Slotted (-)	2.3 - 2.5 (19.8 - 22) *3
	B1, B2	14	14 - 10 (14 - 10)	10	M4	Slotted (-)	1.5 - 1.7 (13.5 - 15)
	⊕	10	14 - 8 (-)	-	M4	Phillips/slotted combo	1.2 - 1.5 (10.6 - 13.3)
4018	R/L1, S/L2, T/L3	10	14 - 6 (14 - 6)	10	M4	Slotted (-)	1.5 - 1.7 (13.5 - 15)
	U/T1, V/T2, W/T3	10	14 - 6 (14 - 6)	10	M4	Slotted (-)	1.5 - 1.7 (13.5 - 15)
	-, +1, +2	8	14 - 3 (14 - 3)	18	M5	Slotted (-)	2.3 - 2.5 (19.8 - 22) *3
	B1, B2	14	14 - 10 (14 - 10)	10	M4	Slotted (-)	1.5 - 1.7 (13.5 - 15)
	⊕	10	14 - 8 (-)	-	M5	Phillips/slotted combo	2.0 - 2.5 (17.7 - 22.1)
4023	R/L1, S/L2, T/L3	8	14 - 6 (14 - 6)	10	M4	Slotted (-)	1.5 - 1.7 (13.5 - 15)
	U/T1, V/T2, W/T3	10	14 - 6 (14 - 6)	10	M4	Slotted (-)	1.5 - 1.7 (13.5 - 15)
	-, +1, +2	8	14 - 3 (14 - 3)	18	M5	Slotted (-)	2.3 - 2.5 (19.8 - 22) *3
	B1, B2	12	14 - 10 (14 - 10)	10	M4	Slotted (-)	1.5 - 1.7 (13.5 - 15)
	⊕	10	12 - 8 (-)	-	M5	Phillips/slotted combo	2.0 - 2.5 (17.7 - 22.1)

### 4.3 UL Standards

Model	Terminals	Recommended Gauge AWG, kcmil	Applicable Gauge (IP20 Applicable Gauge *) AWG, kcmil	Wire Stripping Length *2 mm	Terminal Screw		Tightening Torque N·m (lb·in.)
					Size	Shape	
4031	R/L1, S/L2, T/L3	6	14 - 3 (8 - 3)	18	M5	Slotted (-)	2.3 - 2.5 (19.8 - 22) *3
	U/T1, V/T2, W/T3	8	14 - 4 (10 - 4)	18	M5	Slotted (-)	2.3 - 2.5 (19.8 - 22) *3
	-, +1, +2	6	14 - 1 (8 - 1)	20	M6	Hex socket cap (WAF: 5 mm)	5 - 5.5 (45 - 49)
	B1, B2	10	14 - 8 (14 - 8)	10	M4	Slotted (-)	1.5 - 1.7 (13.5 - 15)
	⊕	8	10 - 6 (-)	-	M6	Phillips/slotted combo	5.4 - 6.0 (47.8 - 53.1)
4038	R/L1, S/L2, T/L3	6	14 - 3 (8 - 3)	18	M5	Slotted (-)	2.3 - 2.5 (19.8 - 22) *3
	U/T1, V/T2, W/T3	8	14 - 4 (10 - 4)	18	M5	Slotted (-)	2.3 - 2.5 (19.8 - 22) *3
	-, +1, +2	4	14 - 1 (8 - 1)	20	M6	Hex socket cap (WAF: 5 mm)	5 - 5.5 (45 - 49)
	B1, B2	10	14 - 8 (14 - 8)	10	M4	Slotted (-)	1.5 - 1.7 (13.5 - 15)
	⊕	6	10 - 6 (-)	-	M6	Phillips/slotted combo	5.4 - 6.0 (47.8 - 53.1)
4044	R/L1, S/L2, T/L3	4	14 - 4 (10 - 4)	18	M5	Slotted (-)	2.3 - 2.5 (19.8 - 22) *3
	U/T1, V/T2, W/T3	6	14 - 6 (10 - 6)	18	M5	Slotted (-)	2.3 - 2.5 (19.8 - 22) *3
	-, +1, +2	3	14 - 3 (10 - 3)	18	M5	Slotted (-)	2.3 - 2.5 (19.8 - 22) *3
	B1, B2	8	14 - 8 (14 - 8)	10	M4	Slotted (-)	1.5 - 1.7 (13.5 - 15)
	⊕	6	8 - 4 (-)	-	M6	Phillips/slotted combo	5.4 - 6.0 (47.8 - 53.1)
4060	R/L1, S/L2, T/L3	4	14 - 4 (10 - 4)	18	M5	Slotted (-)	2.3 - 2.5 (19.8 - 22) *3
	U/T1, V/T2, W/T3	4	14 - 4 (10 - 4)	18	M5	Slotted (-)	2.3 - 2.5 (19.8 - 22) *3
	-, +1	3	14 - 3 (10 - 3)	18	M5	Slotted (-)	2.3 - 2.5 (19.8 - 22) *3
	B1, B2	8	14 - 8 (14 - 8)	10	M4	Slotted (-)	1.5 - 1.7 (13.5 - 15)
	⊕	6	8 - 4 (-)	-	M6	Phillips/slotted combo	5.4 - 6.0 (47.8 - 53.1)

Model	Terminals	Recommended Gauge AWG, kcmil	Applicable Gauge (IP20 Applicable Gauge *) AWG, kcmil	Wire Stripping Length *2 mm	Terminal Screw		Tightening Torque N·m (lb·in.)
					Size	Shape	
4075	R/L1, S/L2, T/L3	3	14 - 3 (12 - 3)	18	M5	Slotted (-)	2.3 - 2.5 (19.8 - 22) *3
	U/T1, V/T2, W/T3	3	14 - 3 (12 - 3)	18	M5	Slotted (-)	2.3 - 2.5 (19.8 - 22) *3
	-, +1	2	14 - 2 (10 - 2)	18	M5	Slotted (-)	2.3 - 2.5 (19.8 - 22) *3
	B1, B2	6	14 - 6 (14 - 6)	10	M4	Slotted (-)	1.5 - 1.7 (13.5 - 15)
	⊕	6	6 - 4 (-)	-	M6	Hex bolt (+)	5.4 - 6.0 (47.8 - 53.1)
4089	R/L1, S/L2, T/L3	2	14 - 2 (10 - 2)	18	M5	Slotted (-)	2.3 - 2.5 (19.8 - 22) *3
	U/T1, V/T2, W/T3	2	14 - 2 (10 - 2)	18	M5	Slotted (-)	2.3 - 2.5 (19.8 - 22) *3
	-, +1	1/0	14 - 1/0 (6 - 1/0)	20	M6	Hex socket cap (WAF: 5 mm)	5 - 5.5 (45 - 49)
	B1, B2	6	14 - 6 (14 - 6)	18	M5	Slotted (-)	2.3 - 2.5 (19.8 - 22) *3
	⊕	4	6 - 4 (-)	-	M6	Hex bolt (+)	5.4 - 6.0 (47.8 - 53.1)
4103	R/L1, S/L2, T/L3	1/0	6 - 2/0 (2 - 2/0)	27	M6	Hex socket cap (WAF: 5 mm)	8 - 9 (71 - 80)
	U/T1, V/T2, W/T3	1	6 - 2/0 (2 - 2/0)	27	M6	Hex socket cap (WAF: 5 mm)	8 - 9 (71 - 80)
	-, +1	2/0	2 - 4/0 (2 - 4/0)	27	M8	Hex socket cap (WAF: 6 mm)	10 - 12 (89 - 107)
	B1, B2	3	14 - 3 (10 - 3)	21	M6	Minus (-)	3 - 3.5 (27 - 31)
	⊕	4	6 - 4 (-)	-	M6	Hex bolt (+)	5.4 - 6.0 (47.8 - 53.1)
4140	R/L1, S/L2, T/L3	3/0	2 - 250 (2/0 - 250)	37	M10	Hex socket cap (WAF: 8 mm)	12 - 14 (107 - 124)
	U/T1, V/T2, W/T3	2/0	2 - 300 (3/0 - 300)	37	M10	Hex socket cap (WAF: 8 mm)	12 - 14 (107 - 124)
	-, -, +1, +1 *4	2	6 - 2/0 (1/0 - 2/0)	28	M6	Hex socket cap (WAF: 5 mm)	8 - 9 (71 - 80)
	B1, B2 *5	1	4 - 2/0 (1 - 2/0)	28	M8	Hex socket cap (WAF: 6 mm)	8 - 9 (71 - 80)
	⊕	4	4 - 1/0 (-)	-	M8	Hex bolt (slotted)	9.0 - 11 (79.7 - 97.4)

### 4.3 UL Standards

Model	Terminals	Recommended Gauge AWG, kcmil	Applicable Gauge (IP20 Applicable Gauge <sup>*1</sup> ) AWG, kcmil	Wire Stripping Length <sup>*2</sup> mm	Terminal Screw		Tightening Torque N·m (lb·in.)
					Size	Shape	
4168	R/L1, S/L2, T/L3	4/0	2 - 250 (2/0 - 250)	37	M10	Hex socket cap (WAF: 8 mm)	12 - 14 (107 - 124)
	U/T1, V/T2, W/T3	4/0	2 - 300 (3/0 - 300)	37	M10	Hex socket cap (WAF: 8 mm)	12 - 14 (107 - 124)
	-, -, +1, +1 <sup>*4</sup>	1/0	6 - 2/0 (1/0 - 2/0)	28	M6	Hex socket cap (WAF: 5 mm)	8 - 9 (71 - 80)
	B1, B2 <sup>*5</sup>	1/0	4 - 2/0 (1 - 2/0)	28	M8	Hex socket cap (WAF: 6 mm)	8 - 9 (71 - 80)
	⊕	4	4 - 1/0 (-)	-	M8	Hex bolt (slotted)	9.0 - 11 (79.7 - 97.4)
4208	R/L1, S/L2, T/L3	1/0 × 2P	3 - 4/0 × 2P (2/0 - 4/0 × 2P)	-	M10	Hex self-locking nut	20 (177)
	U/T1, V/T2, W/T3	1/0 × 2P	3 - 4/0 × 2P (2/0 - 4/0 × 2P)	-	M10	Hex self-locking nut	20 (177)
	-, +1	3/0 × 2P	2 - 250 × 2P (4/0 - 250 × 2P)	-	M10	Hex self-locking nut	20 (177)
	+3	1/0 × 2P	4 - 1/0 × 2P (1/0 × 2P)	-	M10	Hex self-locking nut	20 (177)
	⊕	4	4 - 350 (-)	-	M10	Hex bolt (slotted)	18 - 23 (159 - 204)
4250	R/L1, S/L2, T/L3	2/0 × 2P	3 - 4/0 × 2P (2/0 - 4/0 × 2P)	-	M10	Hex self-locking nut	20 (177)
	U/T1, V/T2, W/T3	2/0 × 2P	3 - 4/0 × 2P (2/0 - 4/0 × 2P)	-	M10	Hex self-locking nut	20 (177)
	-, +1	3/0 × 2P	2 - 250 × 2P (4/0 - 250 × 2P)	-	M10	Hex self-locking nut	20 (177)
	+3	1/0 × 2P	4 - 1/0 × 2P (1/0 × 2P)	-	M10	Hex self-locking nut	20 (177)
	⊕	2	2 - 350 (-)	-	M10	Hex bolt (slotted)	18 - 23 (159 - 204)
4296	R/L1, S/L2, T/L3	3/0 × 2P	3 - 4/0 × 2P (2/0 - 4/0 × 2P)	-	M10	Hex self-locking nut	20 (177)
	U/T1, V/T2, W/T3	3/0 × 2P	3 - 4/0 × 2P (2/0 - 4/0 × 2P)	-	M10	Hex self-locking nut	20 (177)
	-, +1	4/0 × 2P	2 - 250 × 2P (4/0 - 250 × 2P)	-	M10	Hex self-locking nut	20 (177)
	+3	1/0 × 2P	4 - 1/0 × 2P (1/0 × 2P)	-	M10	Hex self-locking nut	20 (177)
	⊕	2	2 - 350 (-)	-	M10	Hex bolt (slotted)	18 - 23 (159 - 204)

Model	Terminals	Recommended Gauge AWG, kcmil	Applicable Gauge (IP20 Applicable Gauge *) AWG, kcmil	Wire Stripping Length *2 mm	Terminal Screw		Tightening Torque N·m (lb·in.)
					Size	Shape	
4371	R/L1, S/L2, T/L3	250 × 2P	2/0 - 300 × 2P (250 - 300 × 2P)	-	M12	Hex self-locking nut	35 (310)
	U/T1, V/T2, W/T3	250 × 2P	2/0 - 300 × 2P (250 - 300 × 2P)	-	M12	Hex self-locking nut	35 (310)
	-, +1	350 × 2P	4/0 - 400 × 2P (300 - 400 × 2P)	-	M12	Hex self-locking nut	35 (310)
	+3	3/0 × 2P	1 - 4/0 × 2P (-)	-	M12	Hex self-locking nut	35 (310)
	⊕	1	1 - 350 (-)	-	M12	Hex bolt (slotted)	32 - 40 (283 - 354)
4389	R/L1, S/L2, T/L3	300 × 2P	2/0 - 300 × 2P (250 - 300 × 2P)	-	M12	Hex self-locking nut	35 (310)
	U/T1, V/T2, W/T3	300 × 2P	2/0 - 300 × 2P (250 - 300 × 2P)	-	M12	Hex self-locking nut	35 (310)
	-, +1	400 × 2P	4/0 - 400 × 2P (300 - 400 × 2P)	-	M12	Hex self-locking nut	35 (310)
	+3	4/0 × 2P	1 - 4/0 × 2P (-)	-	M12	Hex self-locking nut	35 (310)
	⊕	1	1 - 350 (-)	-	M12	Hex bolt (slotted)	32 - 40 (283 - 354)
4453	R/L1, S/L2, T/L3, R1/ L11, S1/L21, T1/L31	250 × 4P	2/0 - 300 × 4P (250 - 300 × 4P)	-	M12	Hex self-locking nut	35 (310)
	U/T1, V/T2, W/T3	4/0 × 4P	2/0 - 300 × 4P (250 - 300 × 4P)	-	M12	Hex self-locking nut	35 (310)
	-, +1	4/0 × 4P	3/0 - 400 × 4P (300 - 400 × 4P)	-	M12	Hex self-locking nut	35 (310)
	+3	3/0 × 4P	2 - 4/0 (4/0 × 4P)	-	M12	Hex self-locking nut	35 (310)
	⊕	1/0	1/0 - 300 (-)	-	M12	Hex bolt (slotted)	32 - 40 (283 - 354)
4568	R/L1, S/L2, T/L3, R1/ L11, S1/L21, T1/L31	250 × 4P	2/0 - 300 × 4P (250 - 300 × 4P)	-	M12	Hex self-locking nut	35 (310)
	U/T1, V/T2, W/T3	4/0 × 4P	2/0 - 300 × 4P (250 - 300 × 4P)	-	M12	Hex self-locking nut	35 (310)
	-, +1	300 × 4P	3/0 - 400 × 4P (300 - 400 × 4P)	-	M12	Hex self-locking nut	35 (310)
	+3	3/0 × 4P	2 - 4/0 × 4P (4/0 × 4P)	-	M12	Hex self-locking nut	35 (310)
	⊕	2/0	2/0 - 300 (-)	-	M12	Hex bolt (slotted)	32 - 40 (283 - 354)

### 4.3 UL Standards

Model	Terminals	Recommended Gauge AWG, kcmil	Applicable Gauge (IP20 Applicable Gauge *) AWG, kcmil	Wire Stripping Length *2 mm	Terminal Screw		Tightening Torque N·m (lb·in.)
					Size	Shape	
4675	R/L1, S/L2, T/L3, R1/ L11, S1/L21, T1/L31	300 × 4P	2/0 - 300 × 4P (250 - 300 × 4P)	-	M12	Hex self-locking nut	35 (310)
	U/T1, V/T2, W/T3	300 × 4P	2/0 - 300 × 4P (250 - 300 × 4P)	-	M12	Hex self-locking nut	35 (310)
	-, +1	400 × 4P	3/0 - 400 × 4P (300 - 400 × 4P)	-	M12	Hex self-locking nut	35 (310)
	+3	4/0 × 4P	2 - 4/0 × 4P (4/0 × 4P)	-	M12	Hex self-locking nut	35 (310)
	⊕	2/0	2/0 - 300 (-)	-	M12	Hex bolt (slotted)	32 - 40 (283 - 354)

\*1 For IP20 protection, use wires that are in the range of applicable gauges.

\*2 Remove insulation from the ends of wires to expose the length of wire shown.

\*3 For wire gauges more than AWG 8, tighten to a tightening torque of 4.1 N·m to 4.5 N·m (36 lb·in. to 40 lb·in.).

\*4 Terminals - and +1 have two screws. The Recommended Gauge is the wire gauge for one terminal.

\*5 A junction terminal is necessary to connect a braking resistor unit (LKEB-series) to terminals B1 and B2.

### ■ Closed-Loop Crimp Terminals

To comply with UL standards on drive models 2257 to 2415 and 4208 to 4675, use UL-approved closed-loop crimp terminals. Use the tools recommend by the terminal manufacturer to crimp the closed-loop crimp terminal. Yaskawa recommends closed-loop crimp terminals from JST Mfg. Co., Ltd. and insulation caps from Tokyo DIP Co., Ltd.

Comply with local standards for correct wire gauges in the region where the drive is used.

Contact Yaskawa or your nearest sales representative to order.

Refer to [Table 4.13](#) to select crimp terminals as specified by drive model and wire gauge.

#### Note:

To comply with UL standards, use only insulated crimp terminals or crimp terminals with insulation tubing. Use UL-Listed, vinyl-coated insulated copper wires for operation with a continuous maximum permitted temperature of 75 °C at 600 V.

**Table 4.13 Closed-Loop Crimp Terminals and Insulation Caps**

Model	Recommended Gauge (AWG, kcmil)					Terminal Screw Size	Crimp Terminal Model	Crimping Tool		Insula tion Cap Model
	R/L1 S/L2 T/L3	U/T1 V/T2 W/T3	-, +1	+3	⊕			Tool Model	Die Jaw	
2004 - 2021	-	-	-	-	10	M4	R5.5-4	YA-4	AD-900	TP-005
2030, 2042	-	-	-	-	8	M5	R8-5	YA-4	AD-901	TP-008
2056	-	-	-	-	6	M6	R14-6	YA-4	AD-902	TP-014
2070 - 2110	-	-	-	-	6	M6	R14-6	YA-4	AD-902	TP-014
2138	-	-	-	-	4	M6	R22-6	YA-5	AD-953	TP-022
2169, 2211	-	-	-	-	4	M8	R22-8	YA-5	AD-953	TP-022
2257	-	-	-	-	3	M10	R38-10	YF-1 YET-150-1	TD-224, TD-212	TP-038
	-	-	-	1/0 × 2P	-		R60-10		TD-225, TD-213	TP-060
	2/0 × 2P	2/0 × 2P	-	-	-		80-10		TD-227, TD-214	TP-080
	-	-	4/0 × 2P	-	-		R100-10		TD-228, TD-214	TP-100

Model	Recommended Gauge (AWG, kcmil)					Terminal Screw Size	Crimp Terminal Model	Crimping Tool		Insulation Cap Model
	R/L1 S/L2 T/L3	U/T1 V/T2 W/T3	-, +1	+3	⊕			Tool Model	Die Jaw	
2313	-	-	-	-	2	M10	R38-10	YF-1 YET-150-1	TD-224, TD-212	TP-038
	-	-	-	1/0 × 2P	-		R60-10		TD-225, TD-213	TP-060
	-	3/0 × 2P	-	-	-		80-10		TD-227, TD-214	TP-080
	4/0 × 2P	-	-	-	-		R100-10		TD-228, TD-214	TP-100
	-	-	250 × 2P	-	-		R150-10		TD-229, TD-215	TP-150
2360	-	-	-	-	1	M12	R60-12	YF-1 YET-300-1	TD-321, TD-311	TP-060
	-	-	-	3/0 × 2P	-		80-12		TD-323, TD-312	TP-080
	250 × 2P	250 × 2P	-	-	-		R150-12		TD-325, TD-313	TP-150
	-	-	350 × 2P	-	-		R200-12		TD-327, TD-314	TP-200
2415	-	-	-	-	1	M12	R60-12	YF-1 YET-300-1	TD-321, TD-311	TP-060
	-	-	-	3/0 × 2P	-		80-12		TD-323, TD-312	TP-080
	250 × 2P	-	-	-	-		R150-12		TD-325, TD-313	TP-150
	-	300 × 2P	-	-	-		R200-12		TD-327, TD-314	TP-200
4002, 4004	-	-	-	-	12	M4	R5.5-4	YA-4	AD-900	TP-005
4005 - 4012	-	-	-	-	10	M4	R5.5-4	YA-4	AD-900	TP-005
4018, 4023	-	-	-	-	10	M5	R5.5-5	YA-4	AD-900	TP-005
4031	-	-	-	-	8	M6	R8-6	YA-4	AD-901	TP-008
4038	-	-	-	-	6	M6	R14-6	YA-4	AD-902	TP-014
4044, 4060	-	-	-	-	6	M6	R14-6	YA-4	AD-902	TP-014
4075	-	-	-	-	6	M6	R14-6	YA-4	AD-902	TP-014
4089, 4103	-	-	-	-	4	M6	R22-6	YA-5	AD-953	TP-022
4140, 4168	-	-	-	-	4	M8	R22-8	YA-5	AD-953	TP-022
4208	-	-	-	-	4	M10	R22-10	YF-1 YET-150-1	TD-223, TD-212	TP-022
	1/0 × 2P	1/0 × 2P	-	1/0 × 2P	-		R60-10		TD-225, TD-213	TP-060
	-	-	3/0 × 2P	-	-		80-10		TD-227, TD-214	TP-080
4250	-	-	-	-	2	M10	R38-10	YF-1 YET-150-1	TD-224, TD-212	TP-038
	-	-	-	1/0 × 2P	-		R60-10		TD-225, TD-213	TP-060
	2/0 × 2P	2/0 × 2P	-	-	-		80-10		TD-227, TD-214	TP-080
	-	-	3/0 × 2P	-	-					

### 4.3 UL Standards

Model	Recommended Gauge (AWG, kcmil)					Terminal Screw Size	Crimp Terminal Model	Crimping Tool		Insulation Cap Model
	R/L1 S/L2 T/L3	U/T1 V/T2 W/T3	- , +1	+3	⊕			Tool Model	Die Jaw	
4296	-	-	-	-	2	M10	R38-10	YF-1 YET-150-1	TD-224, TD-212	TP-038
	-	-	-	1/0 × 2P	-		R60-10		TD-225, TD-213	TP-060
	3/0 × 2P	3/0 × 2P	-	-	-		80-10		TD-227, TD-214	TP-080
	-	-	4/0 × 2P	-	-		R100-10		TD-228, TD-214	TP-100
4371	-	-	-	-	1	M12	R60-12	YF-1 YET-300-1	TD-321, TD-311	TP-060
	-	-	-	3/0 × 2P	-		80-12		TD-323, TD-312	TP-080
	250 × 2P	250 × 2P	-	-	-		R150-12		TD-325, TD-313	TP-150
	-	-	350 × 2P	-	-		R200-12		TD-327, TD-314	TP-200
4389	-	-	-	-	1	M12	R60-12	YF-1 YET-300-1	TD-321, TD-311	TP-060
	-	-	-	4/0 × 2P	-		R100-12		TD-324, TD-312	TP-100
	300 × 2P	300 × 2P	-	-	-		R150-12		TD-325, TD-313	TP-150
	-	-	400 × 2P	-	-		R200-12		TD-327, TD-314	TP-200
4453	-	-	-	-	1/0	M12	R60-12	YF-1 YET-300-1	TD-321, TD-311	TP-060
	-	-	-	3/0 × 4P	-		80-12		TD-323, TD-312	TP-080
	-	4/0 × 4P	4/0 × 4P	-	-		R100-12		TD-324, TD-312	TP-100
	250 × 4P	-	-	-	-		R150-12		TD-325, TD-313	TP-150
4568	-	-	-	-	2/0	M12	80-12	YF-1 YET-300-1	TD-323, TD-312	TP-080
	-	4/0 × 4P	-	-	-		R100-12		TD-324, TD-312	TP-100
	250 × 4P	-	-	-	-		R150-12		TD-325, TD-313	TP-150
	-	-	300 × 4P	-	-					
4675	-	-	-	-	2/0	M12	80-12	YF-1 YET-300-1	TD-323, TD-312	TP-080
	-	-	-	4/0 × 4P	-		R100-12		TD-324, TD-312	TP-100
	300 × 4P	300 × 4P	-	-	-		R150-12		TD-325, TD-313	TP-150
	-	-	400 × 4P	-	-		R200-12		TD-327, TD-314	TP-200

#### ■ Factory-Recommended Branch Circuit Protection

Use branch circuit protection to protect against short circuits and to maintain compliance with UL61800-5-1. Yaskawa recommends connecting semiconductor protection fuses on the input side for branch circuit protection. Refer to [Table 4.14](#) to [Table 4.17](#) for the recommended fuses.



**WARNING! Electrical Shock Hazard.** Do not immediately energize the drive or operate peripheral devices after the drive blows a fuse or trips an RCM/RCD. Wait for the time specified on the warning label at a minimum and make sure that all indicators are OFF. Then check the wiring and peripheral device ratings to find the cause of the problem. Contact Yaskawa before energizing the drive or peripheral devices if the cause is not known. Failure to obey can cause death or serious injury and damage to the drive.

- 200 V class  
Use the fuses specified in this document to prepare the drive for use on a circuit that supplies not more than 100,000 RMS symmetrical amperes and 240 Vac when there is a short circuit in the power supply.
- 400 V class  
Use the fuses specified in this document to prepare the drive for use on a circuit that supplies not more than 100,000 RMS symmetrical amperes and 480 Vac when there is a short circuit in the power supply.

The built-in short circuit protection of the drive does not provide branch circuit protection. The user must provide branch circuit protection as specified by the National Electric Code (NEC), the Canadian Electric Code, Part I (CEC), and local codes.

**Table 4.14 Factory-Recommended Branch Circuit Protection: 200 V Class (ND)**

Drive Model	Maximum Applicable Motor Output kW (HP)	Input Current Rating A	Semiconductor Protection Fuse Rated Current Manufacturer: EATON/ Bussmann
2004	0.75 (0.75)	4.8	FWH-45B
2006	1.1 (1.5)	6.7	FWH-45B
2010	2.2 (3)	12.7	FWH-45B
2012	3 (4)	17	FWH-100B
2018	3.7 (5)	20.7	FWH-100B
2021	5.5 (7.5)	30	FWH-100B
2030	7.5 (10)	40.3	FWH-125B
2042	11 (15)	52	FWH-150B
2056	15 (20)	78.4	FWH-200B
2070	18.5 (25)	96	FWH-225A
2082	22 (30)	114	FWH-225A FWH-250A *1
2110	30 (40)	111	FWH-225A FWH-250A *1
2138	37 (50)	136	FWH-275A FWH-300A *1
2169	45 (60)	164	FWH-275A FWH-350A *1
2211	55 (75)	200	FWH-325A FWH-450A *1
2257	75 (100)	271	FWH-600A
2313	90 (125)	324	FWH-800A
2360	110 (150)	394	FWH-1000A
2415	-	-	-

\*1 Yaskawa recommends a fuse with a large rated current for applications with repeated loads.

**Table 4.15 Factory-Recommended Branch Circuit Protection: 200 V Class (HD)**

Drive Model	Maximum Applicable Motor Output kW (HP)	Input Current Rating A	Semiconductor Protection Fuse Rated Current Manufacturer: EATON/ Bussmann
2004	0.55 (0.5)	3.6	FWH-45B
2006	0.75 (1)	4.8	FWH-45B
2010	1.5 (2)	8.9	FWH-45B

### 4.3 UL Standards

Drive Model	Maximum Applicable Motor Output kW (HP)	Input Current Rating A	Semiconductor Protection Fuse Rated Current Manufacturer: EATON/ Bussmann
2012	2.2 (3)	12.7	FWH-100B
2018	3 (4)	17	FWH-100B
2021	3.7 (5)	20.7	FWH-100B
2030	5.5 (7.5)	30	FWH-125B
2042	7.5 (10)	40.3	FWH-150B
2056	11 (15)	58.2	FWH-200B
2070	15 (20)	78.4	FWH-225A
2082	18.5 (25)	96	FWH-225A FWH-250A *1
2110	22 (30)	82	FWH-225A FWH-250A *1
2138	30 (40)	111	FWH-275A FWH-300A *1
2169	37 (50)	136	FWH-275A FWH-350A *1
2211	45 (60)	164	FWH-325A FWH-450A *1
2257	55 (75)	200	FWH-600A
2313	75 (100)	271	FWH-800A
2360	90 (125)	324	FWH-1000A
2415	110 (150)	394	FWH-1000A

\*1 Yaskawa recommends a fuse with a large rated current for applications with repeated loads.

**Table 4.16 Factory-Recommended Branch Circuit Protection: 400 V Class (ND)**

Drive Model	Maximum Applicable Motor Output kW (HP)	Maximum Applicable Motor Output kW (HP)	Input Current Rating A	Semiconductor Protection Fuse Rated Current Manufacturer: EATON/ Bussmann
	Input Voltage < 460 V	Input Voltage ≥ 460 V		
4002	0.75 (1)	0.75 (1)	2.5	FWH-50B
4004	1.5 (2)	1.5 (2)	4.7	FWH-50B
4005	2.2 (3)	2.2 (3)	6.7	FWH-50B
4007	3.0 (4)	3.0 (4)	8.9	FWH-60B
4009	4.0 (5)	3.7 (5)	11.7	FWH-60B
4012	5.5 (7.5)	5.5 (7.5)	15.8	FWH-60B
4018	7.5 (10)	7.5 (10)	21.2	FWH-80B
4023	11 (15)	11 (15)	30.6	FWH-90B
4031	15 (20)	15 (20)	41.3	FWH-150B
4038	18.5 (25)	18.5 (25)	50.5	FWH-200B
4044	22 (30)	22 (30)	59.7	FWH-200B
4060	30 (40)	30 (40)	58.3	FWH-225A
4075	37 (50)	37 (50)	71.5	FWH-250A
4089	45 (60)	45 (60)	86.5	FWH-275A
4103	55 (75)	55 (75)	105	FWH-275A
4140	75 (100)	75 (100)	142	FWH-300A

Drive Model	Maximum Applicable Motor Output kW (HP) Input Voltage < 460 V	Maximum Applicable Motor Output kW (HP) Input Voltage ≥ 460 V	Input Current Rating A	Semiconductor Protection Fuse Rated Current Manufacturer: EATON/ Bussmann
4168	90 (125)	90 (125)	170	FWH-325A FWH-400A <sup>*1</sup>
4208	110 (150)	110 (150)	207	FWH-500A
4250	132 (175)	150 (200)	248	FWH-600A
4296	160 (200)	185 (250)	300	FWH-700A
4371	200 (250)	220 (300)	373	FWH-800A
4389	220 (300)	260 (350)	410	FWH-1000A
4453	250 (335)	300 (400)	465	FWH-1200A
4568	315 (400)	335 (450)	584	FWH-1200A
4675	355 (450)	370 (500)	657	FWH-1400A FWH-1600A <sup>*1</sup>

\*1 Yaskawa recommends a fuse with a large rated current for applications with repeated loads.

**Table 4.17 Factory-Recommended Branch Circuit Protection: 400 V Class (HD)**

Drive Model	Maximum Applicable Motor Output kW (HP) Input Voltage < 460 V	Maximum Applicable Motor Output kW (HP) Input Voltage ≥ 460 V	Input Current Rating A	Semiconductor Protection Fuse Rated Current Manufacturer: EATON/ Bussmann
4002	0.55 (0.75)	0.55 (0.75)	1.9	FWH-50B
4004	1.1 (1.5)	0.75 (1)	3.5	FWH-50B
4005	1.5 (2)	1.5 (2)	4.7	FWH-50B
4007	2.2 (3)	2.2 (3)	6.7	FWH-60B
4009	3 (4)	3 (4)	8.9	FWH-60B
4012	4.0 (5)	3.7 (5)	11.7	FWH-60B
4018	5.5 (7.5)	5.5 (7.5)	15.8	FWH-80B
4023	7.5 (10)	7.5 (10)	21.2	FWH-90B
4031	11 (15)	11 (15)	30.6	FWH-150B
4038	15 (20)	15 (20)	41.3	FWH-200B
4044	18.5 (25)	18.5 (25)	50.5	FWH-200B
4060	22 (30)	22 (30)	43.1	FWH-225A
4075	30 (40)	30 (40)	58.3	FWH-250A
4089	37 (50)	37 (50)	71.5	FWH-275A
4103	45 (60)	45 (60)	86.5	FWH-275A
4140	55 (75)	55 (75)	105	FWH-300A
4168	75 (100)	75 (100)	142	FWH-325A FWH-400A <sup>*1</sup>
4208	90 (125)	90 (125)	170	FWH-500A
4250	110 (150)	110 (150)	207	FWH-600A
4296	132 (175)	150 (200)	248	FWH-700A
4371	160 (200)	185 (250)	300	FWH-800A
4389	200 (250)	220 (300)	373	FWH-1000A
4453	220 (300)	260 (350)	410	FWH-1200A

### 4.3 UL Standards

Drive Model	Maximum Applicable Motor Output kW (HP) Input Voltage < 460 V	Maximum Applicable Motor Output kW (HP) Input Voltage ≥ 460 V	Input Current Rating A	Semiconductor Protection Fuse Rated Current Manufacturer: EATON/Bussmann
4568	250 (335)	300 (400)	465	FWH-1200A
4675	315 (400)	335 (450)	584	FWH-1400A FWH-1600A <sup>*1</sup>

\*1 Yaskawa recommends a fuse with a large rated current for applications with repeated loads.

### ◆ Low Voltage Wiring for Control Circuit Terminals

You must provide low voltage wiring as specified by the National Electric Code (NEC), the Canadian Electric Code, Part I (CEC), and local codes. Yaskawa recommends the NEC class 1 circuit conductor. Use the UL approved class 2 power supply for external power supply.

**Table 4.18 Control Circuit Terminal Power Supplies**

Input/Output	Terminals	Power Supply Specifications
Digital input	S1 to S8, SN, SC, SP	Uses the LVLC power supply in the drive. Use the UL Listed class 2 power supply for external power supply.
Analog input	A1 to A3, AC, +V, -V	Uses the LVLC power supply in the drive. Use the UL Listed class 2 power supply for external power supply.
Analog output	FM, AM, AC	Uses the LVLC power supply in the drive.
Pulse train output	MP, AC	Uses the LVLC power supply in the drive. Use the UL Listed class 2 power supply for external power supply.
Pulse train input	RP, AC	Uses the LVLC power supply in the drive. Use the UL Listed class 2 power supply for external power supply.
Safe disable input	H1, H2, HC	Uses the LVLC power supply in the drive. Use the UL Listed class 2 power supply for external power supply.
Serial communication input/output	D+, D-, AC	Uses the LVLC power supply in the drive. Use the UL Listed class 2 power supply for external power supply.
24 V external power supply	PS, AC	Use the UL Listed class 2 power supply.

### ◆ Drive Motor Overload and Overheat Protection

The drive motor overload and overheat protection function complies with the National Electric Code (NEC) and the Canadian Electric Code, Part I (CEC).

Set the Motor Rated Current and *L1-01 through L1-04 [Motor Overload Protection Select]* correctly to enable motor overload and overheat protection.

Refer to the control method and set the motor rated current with *E2-01 [Motor Rated Current (FLA)]*, *E5-03 [PM Motor Rated Current (FLA)]*, or *E9-06 [Motor Rated Current (FLA)]*.

#### ■ E2-01: Motor Rated Current (FLA)

No. (Hex.)	Name	Description	Default (Range)
E2-01 (030E)	Motor Rated Current (FLA)	<div style="display: flex; gap: 5px;"> <span>V/f</span> <span>CL-V/f</span> <span>OLV</span> <span>CLV</span> <span>AOLV</span> <span>OLV/PM</span> <span>AOLV/PM</span> <span>CLV/PM</span> <span>EZOLV</span> </div> Sets the motor rated current in amps.	Determined by o2-04 and C6-01 (10% to 200% of the drive rated current)

**Note:**

- If  $E2-01 < E2-03$  [Motor No-Load Current] the drive will detect  $oPE02$  [Parameter Range Setting Error].
- The default settings and setting ranges are in these units:
  - 0.01 A: 2004 to 2042, 4002 to 4023
  - 0.1 A: 2056 to 2415, 4031 to 4675

The value set for  $E2-01$  becomes the reference value for motor protection, the torque limit, and torque control. Enter the motor rated current as written on the motor nameplate. The value of  $E2-01$  is automatically set to the value input for “Motor Rated Current” by the Auto-Tuning process.

### ■ E5-03: PM Motor Rated Current (FLA)

No. (Hex.)	Name	Description	Default (Range)
E5-03 (032B)	PM Motor Rated Current (FLA)	<div style="display: flex; justify-content: space-between; font-size: 0.8em; font-weight: normal;"> <span>V/f</span> <span>CL-V/f</span> <span>OLV</span> <span>CLV</span> <span>AOLV</span> <span style="background-color: #cccccc;">OLV/PM</span> <span style="background-color: #cccccc;">AOLV/PM</span> <span style="background-color: #cccccc;">CLV/PM</span> <span>EZOLV</span> </div> Sets the PM motor rated current (FLA).	Determined by E5-01 (10% to 200% of the drive rated current)

**Note:**

- When the drive model changes, the display units for this parameter also change.
- 0.01 A: 2004 to 2042, 4002 to 4023
  - 0.1 A: 2056 to 2415, 4031 to 4675

The drive automatically sets  $E5-03$  to the value input for “PM Motor Rated Current” after you do these types of Auto-Tuning:

- PM Motor Parameter Settings
- PM Stationary Auto-Tuning
- PM StaTun for Stator Resistance
- PM Rotational Auto-Tuning

### ■ E9-06: Motor Rated Current (FLA)

No. (Hex.)	Name	Description	Default (Range)
E9-06 (11E9)	Motor Rated Current (FLA)	<div style="display: flex; justify-content: space-between; font-size: 0.8em; font-weight: normal;"> <span>V/f</span> <span>CL-V/f</span> <span>OLV</span> <span>CLV</span> <span>AOLV</span> <span style="background-color: #cccccc;">OLV/PM</span> <span style="background-color: #cccccc;">AOLV/PM</span> <span style="background-color: #cccccc;">CLV/PM</span> <span style="background-color: #cccccc;">EZOLV</span> </div> Sets the motor rated current in amps.	Determined by E9-01 and o2-04 (10% to 200% of the drive rated current)

**Note:**

- When the drive model changes, the display units for this parameter also change.
- 0.01 A: 2004 to 2042, 4002 to 4023
  - 0.1 A: 2056 to 2415, 4031 to 4675

The setting value of  $E9-06$  is the reference value for motor protection. Enter the motor rated current shown on the motor nameplate. Auto-Tuning the drive will automatically set  $E9-06$  to the value input for “Motor Rated Current”.

### ■ L1-01: Motor Overload (oL1) Protection

No. (Hex.)	Name	Description	Default (Range)
L1-01 (0480)	Motor Overload (oL1) Protection	<div style="display: flex; justify-content: space-between; font-size: 0.8em; font-weight: normal;"> <span style="background-color: #cccccc;">V/f</span> <span style="background-color: #cccccc;">CL-V/f</span> <span style="background-color: #cccccc;">OLV</span> <span style="background-color: #cccccc;">CLV</span> <span style="background-color: #cccccc;">AOLV</span> <span style="background-color: #cccccc;">OLV/PM</span> <span style="background-color: #cccccc;">AOLV/PM</span> <span style="background-color: #cccccc;">CLV/PM</span> <span style="background-color: #cccccc;">EZOLV</span> </div> Sets the motor overload protection with electronic thermal protectors.	Determined by A1-02 (0 - 6)

This parameter enables and disables the motor overload protection with electronic thermal protectors.

The cooling capability of the motor changes when the speed control range of the motor changes. Use an electronic thermal protector that aligns with the permitted load characteristics of the motor to select motor protection.

The electronic thermal protector of the drive uses these items to calculate motor overload tolerance and supply overload protection for the motor:

- Output current
- Output frequency
- Motor thermal characteristics

• Time characteristics

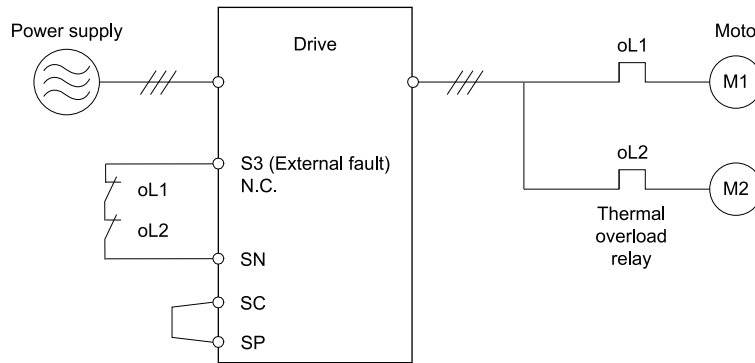
If the drive detects motor overload, the drive will trigger an *oL1* [Motor Overload] and stop the drive output.

Set *H2-01 = 1F* [Term M1-M2 Function Selection = Motor Overload Alarm (oL1)] to set a motor overload alarm. If the motor overload level is more than 90% of the *oL1* detection level, the output terminal turns ON and triggers an overload alarm.

**0 : Disabled**

Disable motor protection when motor overload protection is not necessary or when the drive is operating more than one motor.

Refer to [Figure 4.22](#) for an example of the circuit configuration to connect more than one motor to one drive.



**Figure 4.22 Protection Circuit Configuration to Connect More than One Motor to One Drive**

**NOTICE:** When one drive is operating more than one motor at the same time or when the rated current of the motor is much larger than rated current of a standard motor, you cannot protect the motor with electronic thermal protection. To protect each motor, set *L1-01 = 0* [Motor Overload (oL1) Protection = Disabled], configure the circuits, then add thermal relays to each motor. The magnetic contactor installed for motor protection cannot be switched ON/OFF during run. Failure to obey can cause motor failure.

**1 : Variable Torque**

Use this setting for general-purpose motors with a 60 Hz base frequency.

The overload tolerance decreases as motor speed decreases because the cooling fan speed decreases and the ability of the motor to cool decreases in the low speed range.

The overload tolerance characteristics of the motor change the trigger point for the electronic thermal protector. This provides motor overload protection from low speed to high speed across the full speed range.

Load Tolerance	Cooling Capability	Overload Characteristics (at 100% motor load)
	<p>This motor is designed to operate with commercial line power. Operate at a 60 Hz base frequency to maximize the motor cooling ability.</p>	<p>If the motor operates at frequencies less than 60 Hz, the drive will detect <i>oL1</i>. The drive triggers a fault relay output and the motor coasts to stop.</p>

**2 : Constant Torque 10:1 Speed Range**

Use this setting for drive-dedicated motors with a speed range for constant torque of 1:10.

The speed control for this motor is 10% to 100% when at 100% load. Operating slower than 10% speed at 100% load will cause motor overload.

Load Tolerance	Cooling Capability	Overload Characteristics (at 100% motor load)
	<p>This motor is designed to withstand increased temperatures during continuous operation in the low speed range (10% base frequency).</p>	<p>The motor operates continuously at 10% to 100% base frequency. Operating slower than 10% speed at 100% load will cause motor overload.</p>

### 3 : Constant Torque 100:1 SpeedRange

Use this setting for vector motors with a speed range for constant torque of 1:100.

The speed control for this motor is 1% to 100% when at 100% load. Operating slower than 1% speed at 100% load will cause motor overload.

Load Tolerance	Cooling Capability	Overload Characteristics (at 100% motor load)
	<p>This motor is designed to withstand increased temperatures during continuous operation in the low speed range (1% base frequency).</p>	<p>The motor operates continuously at 1% to 100% base frequency. Operating slower than 1% speed at 100% load will cause motor overload.</p>

### 4 : PM Variable Torque

Use this setting for PM motors with derated torque characteristics.

The overload tolerance decreases as motor speed decreases because the cooling fan speed decreases and the ability of the motor to cool decreases in the low speed range.

The overload tolerance characteristics of the motor change the trigger point for the electronic thermal protector. This provides motor overheat protection from low speed to high speed across the full speed range.

Load Tolerance	Cooling Capability	Overload Characteristics (at 100% motor load)
	<p>This motor is designed to withstand increased temperatures during continuous operation at rated speed and rated torque.</p>	<p>If the motor operates continuously at lower speed than rated rotation speed at more than 100% torque, the drive will detect <i>oLI</i>. The drive triggers a fault relay output and the motor coasts to stop.</p>

### 5 : PM Constant Torque

Use this setting with a PM motor for constant torque that has a speed range for constant torque of 1:500.

The speed control for this motor is 0.2% to 100% when at 100% load. Operating slower than 0.2% speed at 100% load will cause motor overload.

### 4.3 UL Standards

Load Tolerance	Cooling Capability	Overload Characteristics (at 100% motor load)
	<p>This motor is designed to withstand increased temperatures during continuous operation in the low speed range (0.2% base frequency).</p>	<p>The motor operates continuously at 0.2% to 100% rated speed. Operating slower than 0.2% speed at 100% load will cause motor overload.</p>

### 6 : Variable Torque (50Hz)

Use this setting for general-purpose motors with a base frequency of 50 Hz.

The overload tolerance decreases as motor speed decreases because the cooling fan speed decreases and the ability of the motor to cool decreases in the low speed range.

The overload tolerance characteristics of the motor change the trigger point for the electronic thermal protector. This provides motor overload protection from low speed to high speed across the full speed range.

Load Tolerance	Cooling Capability	Overload Characteristics (at 100% motor load)
	<p>This motor is designed to operate with commercial line power. Operate at a 50 Hz base frequency to maximize the motor cooling ability.</p>	<p>If the motor operates at frequencies less than commercial line power, the drive will detect <i>oLI</i>. The drive triggers a fault relay output and the motor coasts to stop.</p>

### ■ L1-02: Motor Overload Protection Time

No. (Hex.)	Name	Description	Default (Range)
L1-02 (0481)	Motor Overload Protection Time	<div style="display: flex; justify-content: space-between; font-size: small;"> <span>V/f</span> <span>CL-V/f</span> <span>OLV</span> <span>CLV</span> <span>AOLV</span> <span>OLV/PM</span> <span>AOLV/PM</span> <span>CLV/PM</span> <span>EZOLV</span> </div> <p>Sets the operation time for the electronic thermal protector of the drive to prevent damage to the motor. Usually it is not necessary to change this setting.</p>	1.0 min (0.1 - 5.0 min)

Set the overload tolerance time to the length of time that the motor can operate at 150% load from continuous operation at 100% load.

When the motor operates at 150% load continuously for 1 minute after continuous operation at 100% load (hot start), the default setting triggers the electronic thermal protector.

Figure 4.23 shows an example of the electronic thermal protector operation time. Motor overload protection operates in the range between a cold start and a hot start.

This example shows a general-purpose motor operating at the base frequency with *L1-02* set to 1.0 min.

- Cold start  
Shows the motor protection operation time characteristics when the overload occurs immediately after starting operation from a complete stop.
- Hot start  
Shows the motor protection operation time characteristics when overload occurs from continuous operation below the motor rated current.



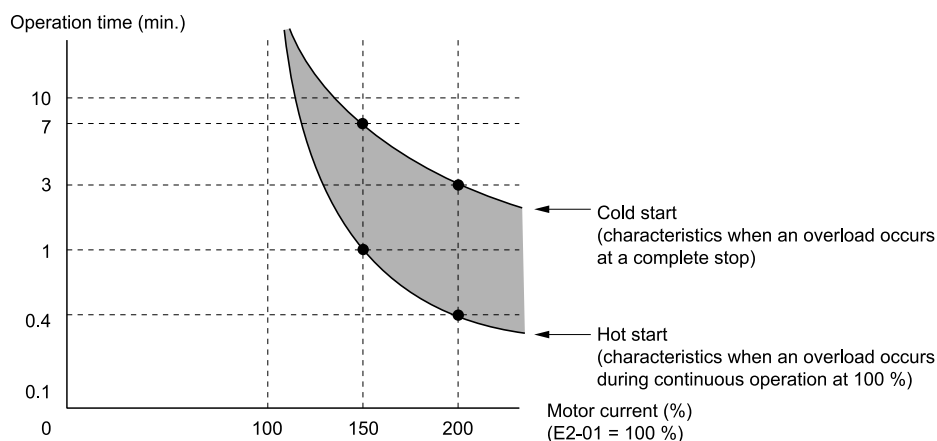


Figure 4.23 Protection Operation Time for a General-purpose Motor at Rated Output Frequency

### ■ L1-03: Motor Thermistor oH Alarm Select

No. (Hex.)	Name	Description	Default (Range)
L1-03 (0482)	Motor Thermistor oH Alarm Select	<b>V/f</b> <b>CL-V/f</b> <b>OLV</b> <b>CLV</b> <b>AOLV</b> <b>OLV/PM</b> <b>AOLV/PM</b> <b>CLV/PM</b> <b>EZOLV</b> Sets drive operation when the PTC input signal entered into the drive is at the <i>oH3</i> [Motor Overheat Alarm] detection level.	3 (0 - 3)

#### 0 : Ramp to Stop

The drive ramps the motor to stop in the deceleration time. Fault relay output terminal MA-MC turns ON and MB-MC turns OFF.

#### 1 : Coast to Stop

The output turns OFF and the motor coasts to stop. Fault relay output terminal MA-MC turns ON, and MB-MC turns OFF.

#### 2 : Fast Stop (Use C1-09)

The drive stops the motor in the deceleration time set in *C1-09* [Fast Stop Time]. Fault relay output terminal MA-MC turns ON, and MB-MC turns OFF.

#### 3 : Alarm Only

The keypad shows *oH3*, and operation continues. The output terminal set for *Alarm* [H2-01 to H2-03 = 10] turns ON.

### ■ L1-04: Motor Thermistor oH Fault Select

No. (Hex.)	Name	Description	Default (Range)
L1-04 (0483)	Motor Thermistor oH Fault Select	<b>V/f</b> <b>CL-V/f</b> <b>OLV</b> <b>CLV</b> <b>AOLV</b> <b>OLV/PM</b> <b>AOLV/PM</b> <b>CLV/PM</b> <b>EZOLV</b> Sets the drive operation when the PTC input signal to the drive is at the <i>oH4</i> [Motor Overheat Fault (PTC Input)] detection level.	1 (0 - 2)

#### 0 : Ramp to Stop

The drive ramps the motor to stop in the deceleration time. Fault relay output terminal MA-MC turns ON and MB-MC turns OFF.

#### 1 : Coast to Stop

The output turns OFF and the motor coasts to stop. Fault relay output terminal MA-MC turns ON, and MB-MC turns OFF.

#### 2 : Fast Stop (Use C1-09)

The drive stops the motor in the deceleration time set in *C1-09* [Fast Stop Time]. Fault relay output terminal MA-MC turns ON, and MB-MC turns OFF.

## 4.4 China RoHS Compliance



**Figure 4.24 China RoHS Mark**

The China RoHS mark is displayed on products containing six specified hazardous substances that are in excess of regulatory limits, based on the “Administrative Measures for the Restriction of the Use of Hazardous Substances in Electrical and Electronic Products” and “Marking for the Restricted Use of Hazardous Substances in Electronic and Electrical Products” (SJ/T 11364-2014), which were promulgated on January 26, 2016. The number displayed in the center of the mark indicates the environment-friendly use period (number of years) in which electrical and electronic products that are being produced, sold, or imported to China can be used. The date of manufacture of the electrical and electronic product is the starting date of the environment-friendly use period for the product. The six specified hazardous substances contained in the product will not leak outside of the product during normal use within this period and will have no serious impact on the environment, the human body, or property.

The environment-friendly use period for this product is 15 years. This period is not the product warranty period.

**Note:**

This mark will be added to factory shipments from late June 2016. There may be a mix of products that reflect or do not reflect this change during the distribution stage. Thank you for your understanding.

### ◆ Information on Hazardous Substances in This Product

Table 4.19 shows the details on hazardous substances contained in this product.

**Table 4.19 Contents of Hazardous Substances in This Product**

Parts Name	Hazardous Substances					
	Lead (Pb)	Mercury (Hg)	Cadmium (Cd)	Hexavalent Chromium (Cr (VI))	Polybrominated Biphenyls (PBB)	Polybrominated Diphenyl Ethers (PBDE)
Circuit Board	×	○	○	○	○	○
Electronic Parts	×	○	○	○	○	○
Brass Screw	×	○	○	○	○	○
Aluminum Die Casting	×	○	○	○	○	○

This table has been prepared in accordance with the provisions outlined in SJ/T 11364.

○: Indicates that said hazardous substance contained in all of the homogeneous materials for this part is below or equal to the limit requirement of GB/T 26572.

×: Indicates that said hazardous substance contained in at least one of the homogeneous materials used for this part is above the limit requirement of GB/T 26572.

**Note:**

This product complies with EU RoHS directives. In this table, "×" indicates that hazardous substances that are exempt from EU RoHS directives are contained.

## 4.5 对应中国RoHS指令



图 4.25 中国RoHS标志

中国RoHS标志依据2016年1月26日公布的《电器电子产品有害物质限制使用管理办法》，以及《电子电气产品有害物质限制使用标识要求》（SJ/T 11364-2014）作成。电子电气产品中特定6种有害物质的含量超过规定值时，应标识此标志。中间的数字为在中国生产销售以及进口的电子电气产品的环保使用期限（年限）。电子电气产品的环保使用期限从生产日期算起。在期限内，正常使用产品的过程中，不会有特定的6种有害物质外泄进而对环境、人和财产造成深刻影响。

本产品的环保使用期限为15年。但需要注意的是环保使用期限并非产品的质量保证期限。

（注）2016年6月下旬以后出厂的产品会依次进行标识。此外，标识和未标识的产品可能会在物流阶段混在一起，敬请注意。

### ◆ 本产品中含有有害物质的信息

本产品中所含有害物质的详细信息如表 4.20 所示。

表 4.20 本产品中有害物质的名称及含量

部件名称	有害物质					
	铅(Pb)	汞(Hg)	镉(Cd)	六价铬(Cr(VI))	多溴联苯(PBB)	多溴二苯醚(PBDE)
实装基板	×	○	○	○	○	○
电子元件	×	○	○	○	○	○
黄铜螺钉	×	○	○	○	○	○
铝压铸	×	○	○	○	○	○

本表格依据SJ/T 11364的规定编制。  
 ○：表示该有害物质在该部件所有均质材料中的含量均在GB/T 26572规定的限量要求以下。  
 ×：表示该有害物质至少在该部件的某一均质材料中的含量超出GB/T 26572规定的限量要求。  
 （注） 本产品符合欧盟RoHS指令。上表中的“×”表示含有欧盟RoHS指令豁免的有害物质。

## 4.6 Safe Disable Input



**Figure 4.26 TUV Mark**

The TUV mark identifies that the product complies with the safety standards.

This section gives precautions to support the Safe Disable input. Contact Yaskawa for more information.

The safety function complies with the standards shown in [Table 4.21](#).

**Table 4.21 Applied Safety Standards and Unified Standards**

Safety Standards	Unified Standards
Functional Safety	IEC/EN 61508:2010 (SIL3)
	IEC/EN 62061/A2:2015 (SILCL3)
	IEC/EN 61800-5-2:2007 (SIL3)
Machine Safety	ISO/EN ISO 13849-1:2015 (Cat.3, PL e)
EMC	IEC/EN 61000-6-7:2015, IEC/EN61326-3-1:2008

**Note:**

SIL = Safety Integrity Level.

### ◆ Safe Disable Specifications

The Safe Disable input provides the stop function compliant to “Safe Torque Off” defined in IEC/EN 61800-5-2:2007. The Safe Disable input is designed to meet the requirements of EN ISO 13849-1 and IEC/EN 61508. It is also equipped with the safety status monitor to detect safety circuit errors.

When you install the drive as a component in a system, you must make sure that the system complies with the applicable safety standards.

Refer to [Table 4.22](#) for safety function specifications.

**Table 4.22 Specifications for the Safety Function**

Item	Description
Input/output	<ul style="list-style-type: none"> <li>Input: 2 Safe Disable input (H1, H2) Signal ON level: 18 Vdc to 28 Vdc Signal OFF level: -4 Vdc to +4 Vdc</li> <li>Output: 1 MFDO safety monitor output for external device monitor (EDM)</li> </ul>
Response time from opening the input to stopping the drive output	3 ms or less
Response time from opening H1 and H2 terminal inputs to operating the EDM signal	20 ms or less
Failure probability	Less frequent operation request mode PFD = 4.65E-6
	Frequent operation request mode or continuous mode PFH = 1.11E-9
Performance level	The Safe Disable input complies with the performance level requirements of EN ISO 13849-1.
HFT (hardware fault tolerance)	N = 1
Type of subsystem	Type B

**Note:**

EDM = External Device Monitoring

PFD = Probability of Failure on Demand

PFH = Probability of Dangerous Failure per Hour

## ◆ Notes

**DANGER!** *Sudden Movement Hazard. Make sure that the full system or machinery in which the Safe Disable function is used complies with safety requirements. When implementing the Safe Disable function into the safety system of a machine, do a full risk assessment for the system to make sure that all parts of the system comply with applicable safety standards. Incorrect application of the Safe Disable function will cause serious injury or death.*

**DANGER!** *Sudden Movement Hazard. An external holding brake or dynamic brake are NOT drive safety components. Systems that use an external holding brake or dynamic brake with a drive output signal (including EDM) are not safe systems because the drive output signal is not a safety component. You must use a system that satisfies the safety requirements. Failure to obey will cause death or serious injury.*

**DANGER!** *Sudden Movement Hazard. Connect the Safe Disable inputs to the devices as specified by the safety requirements. Failure to obey will cause death or serious injury.*

**WARNING!** *Sudden Movement Hazard. With PM motors, the failure of two output transistors can cause current to flow through the motor winding and move the motor output axis 180 electrical degrees. This is possible when the Safe Disable function turns off the drive output. Make sure that output transistors failure will not effect the safety of the application when with the Safe Disable function. Failure to obey could cause death or serious injury.*

**WARNING!** *Electrical Shock Hazard. The Safe Disable function will turn off the drive output, but it will not stop the drive power supply and it cannot electrically isolate the drive output from the input. Always turn off the drive power supply during maintenance and installations on the drive input and output sides. Failure to obey could cause death or serious injury.*

**WARNING!** *Sudden Movement Hazard. An external gravitational force in the vertical axis will move the motor although the Safe Disable function is in operation. Failure to obey could cause serious injury or death.*

**WARNING!** *Sudden Movement Hazard. Remove the pre-installed wire links between terminals H1-HC and H2-HC to use the Safe Disable inputs. Failure to obey will prevent correct operation of the Safe Disable circuit and could cause death or serious injury.*

**WARNING!** *Sudden Movement Hazard. Regularly examine the Safe Disable input and all other safety features. A system that does not operate correctly can cause death or serious injury.*

**WARNING!** *Sudden Movement Hazard. Only let approved technicians with full knowledge of the drive, the instruction manual, and safety standards wire, examine, and maintain the Safe Disable input. Failure to obey could cause death or serious injury.*

**NOTICE:** *A maximum of 3 ms will elapse from when terminals H1 or H2 shut off until the drive switches to the "Safe Torque Off" status. Set the OFF status for terminals H1 and H2 to hold for at least 2 ms. The drive may not be able to switch to the "Safe Torque Off" status if terminals H1 and H2 are only open for less than 2 ms.*

**NOTICE:** *Only use the Safe Disable Monitor (multi-function output terminal set to the EDM function) to monitor the Safe Disable status or to find a malfunction in the Safe Disable inputs. The monitor output is not a safety output.*

**NOTICE:** *Drives that have a built-in safety function must be replaced 10 years after first use.*

## ◆ Using the Safe Disable Function

### ■ Safe Disable Circuit

The Safe Disable circuit has two isolated channels (terminals H1 and H2) that stop the output transistors. The input can use the internal power supply of the drive.

Set the EDM function to one of the MFDO terminals [ $H2-xx = 21$  or  $121$ ] to monitor the status of the Safe Disable function. This is the "Safe Disable monitor output function".

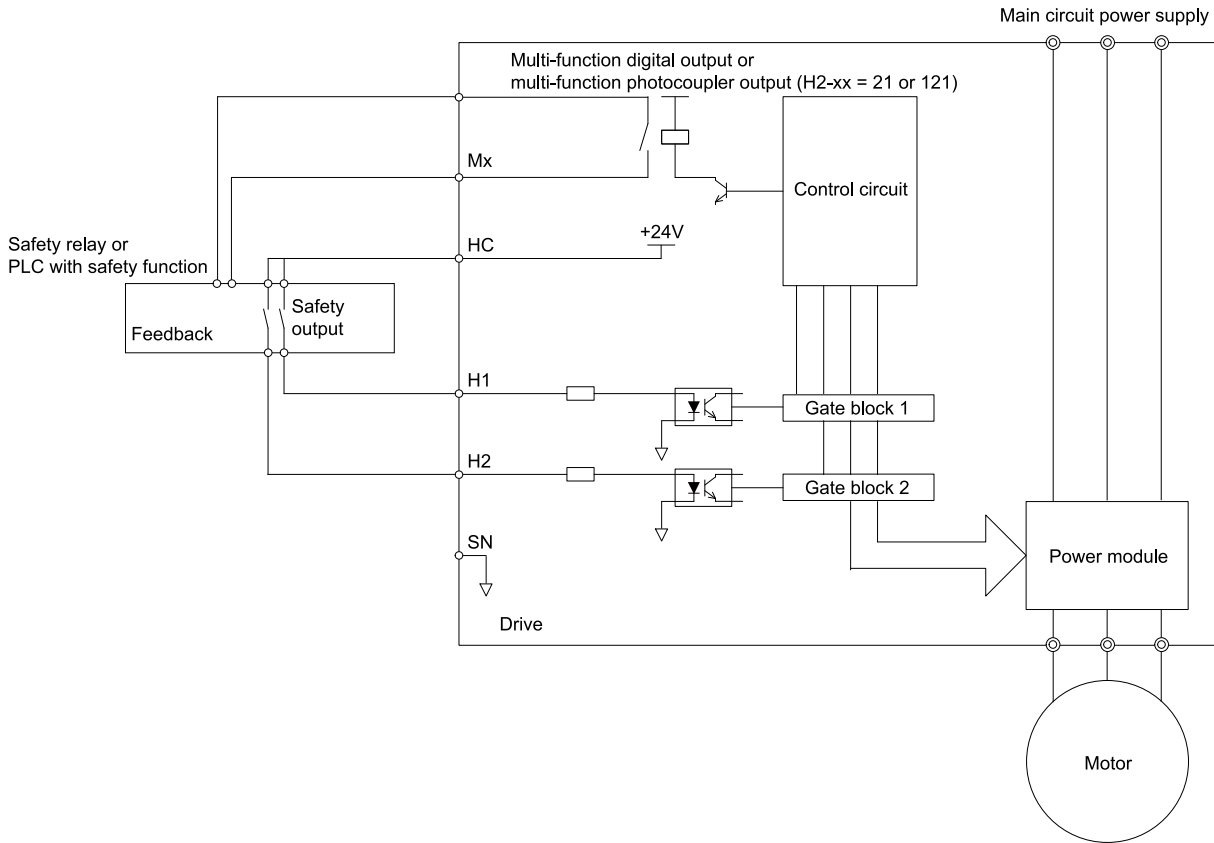


Figure 4.27 Safe Disable Function Wiring Example

■ Enabling and Disabling the Drive Output (“Safe Torque Off”)

Refer to Figure 4.28 for an example of drive operation when as the drive changes from the "Safe Torque Off" status to usual operation.

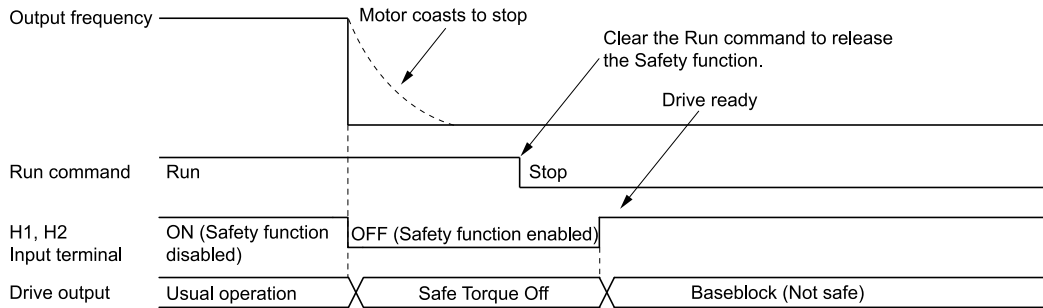


Figure 4.28 Safe Disable Operation

Switching from Usual Operation to “Safe Torque Off”

Turn OFF (open) safety input terminal H1 or H2 to enable the Safe Disable function. When the Safe Disable function is enabled while the motor is operating, the drive output and motor torque turn off and the motor always coasts to stop. The *b1-03 [Stopping Method Selection]* setting does not have an effect on the stopping method.

The “Safe Torque Off” status is only possible with the Safe Disable function. Clear the Run command to stop the drive. Turning off drive output (a baseblock condition) ≠ “Safe Torque Off”.

**NOTICE:** A maximum of 3 ms will elapse from when terminals H1 or H2 shut off until the drive switches to the "Safe Torque Off" status. Set the OFF status for terminals H1 and H2 to hold for at least 2 ms. The drive may not be able to switch to the "Safe Torque Off" status if terminals H1 and H2 are only open for less than 2 ms.

Note:

Turn OFF terminals H1 and H2 after the motor fully stops. This will prevent the motor from coasting to stop during usual operation.

Going from “Safe Torque Off” to Usual Operation

The safety input will only release when there is no Run command.

• During Stop:

When the Safe Disable function is triggered during stop, close the circuit between terminals H1-HC and H2-HC to disable “Safe Torque Off”. Enter the Run command after the drive stops correctly.

- During Run:  
When the Safe Disable function is triggered during run, close the circuit between terminals H1-HC and H2-HC to disable "Safe Torque Off" after clearing the Run command. Enter the Stop command, then enter the Run command when terminals H1 and H2 are ON or OFF.

## ■ Safe Disable Monitor Output Function and Keypad Display

Refer to [Table 4.23](#) for information about the relation between the input channel status, Safety monitor output status, and drive output status.

**Table 4.23 Safe Disable Input and External Device Monitor (EDM) Terminal Status**

Input Channel Status		Safety Monitor Output Status		Drive Output Status	Keypad Display	LED Status Ring
Input 1 (H1-HC)	Input 2 (H2-HC)	MFDO Terminal (H2-xx = 21)	MFDO Terminal (H2-xx = 121)			
ON (Close the circuit)	ON (Close the circuit)	OFF	ON	Baseblock (Drive ready)	Normally displayed	Ready: Illuminated
OFF (Open)	ON (Close the circuit)	OFF	ON	Safety status (STo)	SToF (Flashing)	ALM/ERR: Flashing
ON (Close the circuit)	OFF (Open)	OFF	ON	Safety status (STo)	SToF (Flashing)	ALM/ERR: Flashing
OFF (Open)	OFF (Open)	ON	OFF	Safety status (STo)	STo (Flashing)	Ready: Flashing

### Safety Function Status Monitor

The drive Safety monitor output sends a feedback signal about the status of the Safety function. The Safety monitor output is one of the possible settings available for the MFDO terminals. If there is damage to the Safe Disable circuit, a controller (PLC or safety relay) must read this signal as an input signal to hold the "Safe Torque Off" status. This will help verify the condition of the safety circuit. Refer to the manual for the safety device for more information about the Safety function.

It is possible to switch polarity of the Safety monitor output signal with the MFDO function settings. Refer to [Table 4.23](#) for setting instructions.

### Keypad Display

If the two input channels are OFF (Open), the keypad will flash *STo* [*Safe Torque OFF*].

If there is damage to the Safe disable circuit or the drive, the keypad will flash *SToF* [*Safe Torque OFF Hardware*] when one input channel is OFF (Open), and the other is ON (Short circuit). When you use the Safe disable circuit correctly, the keypad will not show *SToF*.

If there is damage to the drive, the keypad will show *SCF* [*Safety Circuit Fault*] when the drive detects a fault in the Safe disable circuit. Refer to the chapter on Troubleshooting for more information.

## ■ Validating the Safe Disable Function

After you replace parts or do maintenance on the drive, first complete all necessary wiring to start the drive, then test the Safe Disable input with these steps. Keep a record of the test results.

- When the two input channels are OFF (Open), make sure that the keypad flashes *STo* [*Safe Torque OFF*], and make sure that the motor is not running.
- Monitor the ON/OFF status of the input channels and make sure that MFDO set to the EDM function operates as shown in [Table 4.23](#).

If one or more of the these items are true, the ON/OFF status of the MFDO may not display correctly on the keypad:

- Incorrect parameter settings.
- A problem with an external device.
- The external wiring has a short circuit or is disconnected.
- There is damage to the device.

Find the cause and repair the problem to correctly display the status.

- Make sure that the EDM signal operates during usual operation as shown in [Table 4.23](#).





## Network Communications

---

5.1	Safety Precautions .....	290
5.2	Field Bus Network Support.....	291
5.3	MEMOBUS/Modbus Communications .....	292

## 5.1 Safety Precautions

### DANGER

**Do not ignore the safety messages in this manual. The operating company is responsible for injuries or equipment damage caused from ignoring the messages in this manual.**

Failure to obey the safety messages will cause death or serious injury.

## 5.2 Field Bus Network Support

You can use the PLC to control and monitor the drive through the network. The drive has a standard RS-485 interface (MEMOBUS/Modbus communications). Install a separately sold communication option on the drive to support other network communications.

### ◆ Available Communication Options

Refer to [Table 5.1](#) for the field bus networks that are compatible with the drive. Contact Yaskawa or your nearest sales representative to order a communication option.

**Table 5.1 Available Field Bus Network**

Type of Communications	Option model	Type of Communications	Option model
CC-Link	SI-C3	DeviceNet	SI-N3
MECHATROLINK-II	SI-T3	LonWorks	SI-W3
MECHATROLINK-III	SI-ET3	Modbus TCP/IP	SI-EM3
PROFIBUS-DP	SI-P3	PROFINET	SI-EP3
CANopen	SI-S3	EtherNet/IP	SI-EN3
EtherCAT	SI-ES3		

## 5.3 MEMOBUS/Modbus Communications

This section gives detailed information about the parameters, error codes and communication procedures for MEMOBUS/Modbus communications.

### ◆ Configure Master/Slave

You can use the MEMOBUS/Modbus protocol for serial communication with programmable controllers (PLC). The MEMOBUS/Modbus communication uses one master (PLC) and a maximum of 31 slave drives. Serial communications usually starts with a signal from the master to the slave drives.

A slave drive that receives a command from the master does the specified function and then sends a response back to the master. You must set the address number for each slave drive before you start signal communications to make sure that the master uses the correct address numbers.

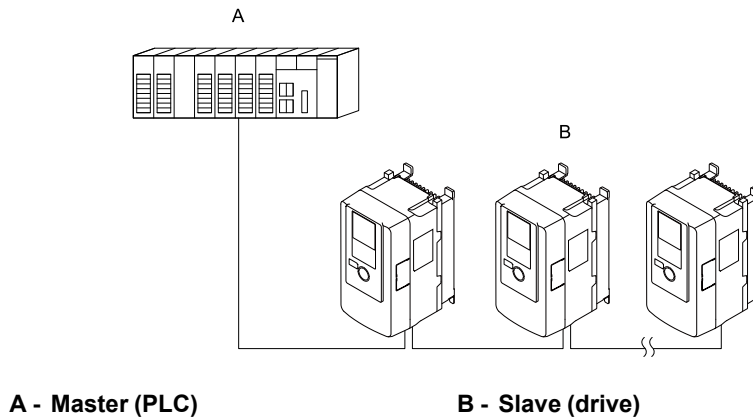


Figure 5.1 PLC and Drive Connection Example

### ◆ Communication Specifications

Table 5.2 lists the specifications for the MEMOBUS/Modbus communications.

Table 5.2 MEMOBUS/Modbus Specifications

Item	Specification
Interface	RS-485
Synchronization method	Asynchronous (start-stop synchronization)
Communication parameter	Communications speed: 1.2, 2.4, 4.8, 9.6, 19.2, 38.4, 57.6, 76.8, 115.2 kbps
	Data length: 8 bit (fixed)
	Parity: even, odd, none
	Stop bit 1 bit (fixed)
Communication protocol	MEMOBUS/Modbus standard (RTU mode only)
Number of possible units to connect	Maximum: 31 units

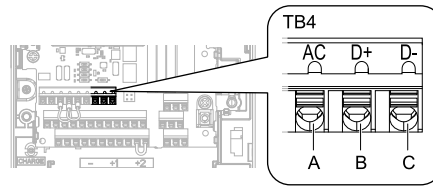
### ◆ Communication with the PLC

This section gives information about the settings for the termination resistor and how to connect to MEMOBUS/Modbus communications. MEMOBUS/Modbus communications uses an RS-485 interface (2-wire sequence).

#### ■ Connect Communications Cable

Use this procedure to start communication between the PLC and drive.

1. De-energize the drive then connect the communications cable to the PLC and the drive. The drive uses terminal TB4 for MEMOBUS/Modbus communications.



**A - Terminal AC: Signal ground**  
**B - Terminal D+: Communication input/output (+)**

**C - Terminal D-: Communication input/output (-)**

**Figure 5.2 Communications Cable Connection Terminal (TB4)**

**Note:**

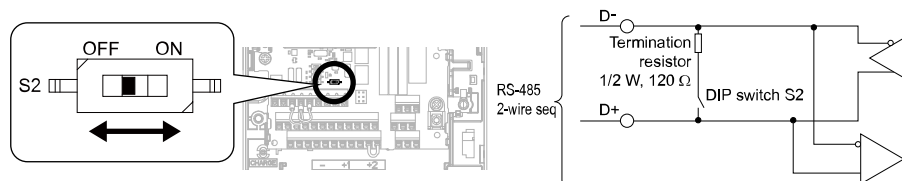
Isolate the communications wiring from the main circuit wiring and other high-power wiring. Use shielded wires for the communications wiring and connect cable sheaths to the ground terminal of the drive. Incorrect wiring procedures could cause drive malfunction because of electrical interference.

2. Install the termination resistor on the network termination slave drive. Set the DIP switch S2 to the ON position to enable the termination resistor on the drive.
3. Energize the drive.
4. Use the drive keypad to set the necessary communications parameters *H5-01 to H5-12*.
  - *H5-01 [Drive Node Address]*
  - *H5-02 [Communication Speed Selection]*
  - *H5-03 [Communication Parity Selection]*
  - *H5-04 [Stopping Method after Com Error]*
  - *H5-05 [Comm Fault Detection Select]*
  - *H5-06 [Drive Transmit Wait Time]*
  - *H5-09 [CE Detection Time]*
  - *H5-10 [Modbus Register 0025H Unit Sel]*
  - *H5-11 [Communications ENTER Func Select]*
  - *H5-12 [Run Command Method Selection]*
5. De-energize the drive and wait for the keypad display to turn off.
6. Energize the drive.

The drive is prepared to start communication with the PLC.

### ■ Set the Termination Resistor

You must enable the termination resistor on the slave terminal of the drive to use MEMOBUS/Modbus communications. Use DIP switch S2 on the terminal block to enable and disable the built-in termination resistor. Refer to [Figure 5.3](#) for an example of how to set DIP switch S2. Use the tip of a tweezers or a jig with a tip width of 0.8 mm (0.03 in.) to set the DIP switch. When you install the drive in the terminal of the communication line, set DIP switch S2 to ON. Set DIP switch S2 to OFF on all other drives.



**Figure 5.3 MEMOBUS/Modbus Communication Terminal and DIP Switch S2**

### ■ Wiring Diagram for More than One Drive

[Figure 5.4](#) shows how to wire more than one connected drive with using MEMOBUS/Modbus communications.

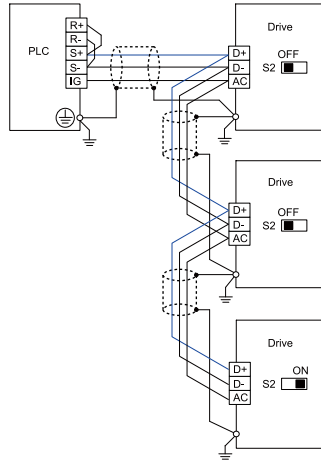


Figure 5.4 Wiring Diagram for More than One Drive

**Note:**

Set DIP switch S2 to the ON position on the last drive of the MEMOBUS/Modbus communication network to enable the termination resistor.

◆ **MEMOBUS/Modbus Drive Operations**

Drive parameters will apply to the settings when the drive is running during MEMOBUS/Modbus communications. This section gives information about the available functions and their related parameters.

■ **Executable Functions**

A PLC can do these operations with MEMOBUS/Modbus communications. Parameter settings (except H5-xx) do not have an effect on the availability of these operations.

- Monitor the drive status and operate the drive
- Set and view parameters
- Reset a fault
- Multi-function input setting (The input command from MEMOBUS/Modbus communications and MFDI terminals (S1 to S8) are linked by a logical OR operation.)

■ **Drive Control**

Select the external command that sets the frequency references and motor run/stop with MEMOBUS/Modbus communications. Use the information in Table 5.3 to set the parameters as specified by the application.

Table 5.3 Required Parameter Settings for Drive Control from MEMOBUS/Modbus

LOCAL Control Selected	No.	Name	Setting Value
External reference 1	b1-01	Frequency Reference Selection 1	2 [Memobus/Modbus Communications]
	b1-02	Run Command Selection 1	2 [Memobus/Modbus Communications]
External reference 2	b1-15	Frequency Reference Selection 2	2 [Memobus/Modbus Communications]
	b1-16	Run Command Selection 2	2 [Memobus/Modbus Communications]

For more information about operation mode selection, refer to b1-01 [Frequency Reference Selection 1] and b1-02 [Run Command Selection 1]. Refer to H1-xx = 2 [MFDI Function Select = External Reference 1/2 Selection] for more information about external command.

◆ **Communications Timing**

To prevent overrun of the slave side, the master cannot send a message to the same drive for a selected length of time.

To prevent overrun of the master side, the slave cannot send a response message to the master for a selected length of time.

This section gives information about message timing.

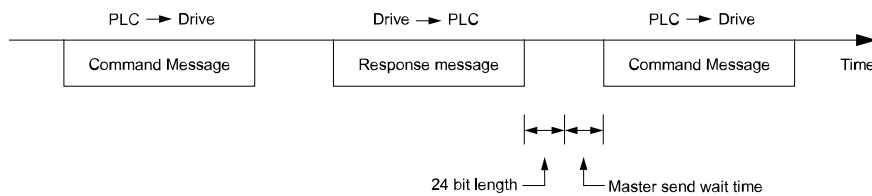
### ■ Command Message from Master to Slave

To prevent data loss and overrun, after the master receives a message from the slave, the master cannot send the same type of command message to the same slave for a selected length of time. The minimum wait time is different for each type of message. Refer to [Table 5.4](#) to find the minimum wait times.

**Table 5.4 Minimum Wait Time to Send a Message**

Command Type	Example	Minimum Wait Time
1	<ul style="list-style-type: none"> <li>Operation commands (Run command, stop command)</li> <li>I/O settings</li> <li>Reading the motor and parameter setting values</li> </ul>	5 ms <sup>*1</sup>
2	Writing a parameter	50 ms <sup>*1</sup>
3	Writing of modified data with the Enter command	3 to 5 s <sup>*1</sup>

\*1 When the drive receives a message in the minimum wait time, it does command type 1 and sends a response message. If the drive receives command type 2 or command type 3 messages in the minimum wait time, it will trigger a communications error or the drive will ignore the command.

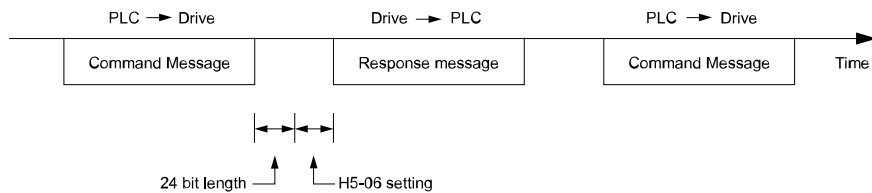


**Figure 5.5 Minimum Wait Time to Send a Message**

You must set the timer in the master to measure the length of time for the slave to respond to the master. If you set the timer, but the slave does not send a response message in a specified length of time, the master will send the message again.

### ■ Response Message from Slave

The slave receives the command message from the master then processes the data it received. The slave then waits for the time set in *H5-06 [Drive Transmit Wait Time]* then sends a response message to the master. If overrun occurs on the master, increase the wait time set in *H5-06*.

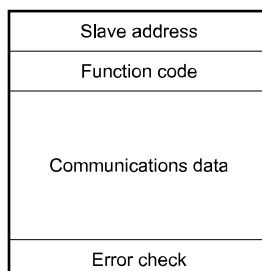


**Figure 5.6 Response Wait Time**

## ◆ Message Format

### ■ Communication Message Description

In MEMOBUS/Modbus communications, the master sends commands to the slave, then the slave responds. The master and slave send their messages in the configuration in [Figure 5.7](#). The length of the data changes when the description of the command (function) changes.



**Figure 5.7 Message Format**

## ■ Slave Address

Set the slave address of the drive to 00 to FF (Hex.). When the slave address is 00 (Hex), the master sends the command and all slaves receive the command.

The slave will not send a response message to the master.

## ■ Function Code

There are five function codes that set commands. [Table 5.5](#) shows the different codes.

**Table 5.5 Function Codes**

Function Code (Hex.)	Subfunction Code (Hex.)	Function	Command Message		Response Message	
			Minimum Data Length (byte)	Maximum Data Length (byte)	Minimum Data Length (byte)	Maximum Data Length (byte)
03	-	Read the Description of Holding Register	8	8	7	37
08	-	Loopback Test	8	8	8	8
10	-	Writing to Multiple Holding Registers	11	41	8	8
5A	-	Writing to Multiple Holding Registers / Reading the Register Indicated	11	41	17	17
67	010D	Reading Contents of Non-Consecutive Holding Registers	10	248	10	248
	010E	Writing to Non-Consecutive Holding Registers	14	250	8	8

## ■ Communications Data

Communications data is a series of data that uses the combination of the communications register number and the data for these registers. The data length changes when the description of the command changes. For a loopback test, it switches to test code.

The communications register for the drive has a 2-byte length. Data that is written to the register for the drive is usually 2 bytes. Register data that is read from the drive is also 2 bytes.

## ■ Error Check

Error check uses the CRC-16 method to detect transmission errors. Use the procedure in this section to calculate CRC-16.

### Command Data

When the drive receives data, it will make sure that there are no errors in the data. The drive uses the procedure below to calculate CRC-16, then compares that data with the CRC-16 value in the message. If the CRC-16 values do not agree, the drive will not execute a command message.

When you calculate CRC-16 in MEMOBUS/Modbus communications, make sure that you set the start value as FFFF (Hex.). All 16 bits must be 1.

Use this procedure to calculate CRC-16:

1. Make sure that the start value is FFFF (Hex.).
2. Calculate the FFFF (Hex.) start value and the XOR of the slave address (exclusive OR).
3. Move the step 2 results one column to the right. Do this shift until the carry bit is 1.
4. When the carry bit is 1, calculate XOR via the result from the above step 3 and A001 (Hex.).
5. Do steps 3 and 4 until the 8th shift to the right.
6. Use the result of step 5 to calculate the XOR and the data of the following messages (function code, register address, data). Do steps 3 to 5 until the last data, then calculate.



7. The result of the last right shift or the value of the last XOR calculation is the result for CRC-16.

Figure 5.8 lists examples of the CRC-16 calculation of slave address 02 (Hex.) and function code 03 (Hex.). The calculated results of CRC-16 for this section is D140 (Hex.).

**Note:**

The calculation example only gives information about some error checks with CRC-16. The drive will do the same error checks for the next data.

Description	Calculation	Overflow	Description	Calculation	Overflow
Initial value (FFFF(Hex.))	1111 1111 1111 1111		Function code 03 (Hex.)	0000 0011	
Address 02 (Hex.)	0000 0010		XOR w result	1000 0001 0011 1101	
XOR w initial value	1111 1111 1111 1101		Shift 1	0100 0000 1001 1110	1
Shift 1	0111 1111 1111 1110	1	XOR w A001 (Hex.)	1010 0000 0000 0001	
XOR w A001 (Hex.)	1010 0000 0000 0001		XOR result	1110 0000 1001 1111	
XOR result	1101 1111 1111 1111		Shift 2	0111 0000 0100 1111	1
Shift 2	0110 1111 1111 1111	1	XOR w A001 (Hex.)	1010 0000 0000 0001	
XOR w A001 (Hex.)	1010 0000 0000 0001		XOR result	1101 0000 0100 1110	
XOR result	1100 1111 1111 1110		Shift 3	0110 1000 0010 0111	0
Shift 3	0110 0111 1111 1111	0	Shift 4	0011 0100 0001 0011	1
Shift 4	0011 0011 1111 1111	1	XOR w A001 (Hex.)	1010 0000 0000 0001	
XOR w A001 (Hex.)	1010 0000 0000 0001		XOR result	1001 0100 0001 0010	
XOR result	1001 0011 1111 1110		Shift 5	0100 1010 0000 1001	0
Shift 5	0100 1001 1111 1111	0	Shift 6	0010 0101 0000 0100	1
Shift 6	0010 0100 1111 1111	1	XOR w A001 (Hex.)	1010 0000 0000 0001	
XOR w A001 (Hex.)	1010 0000 0000 0001		XOR result	1000 0101 0000 0101	
XOR result	1000 0100 1111 1110		Shift 7	0100 0010 1000 0010	1
Shift 7	0100 0010 0111 1111	0	XOR w A001 (Hex.)	1010 0000 0000 0001	
Shift 8	0010 0001 0011 1111	1	XOR result	1110 0010 1000 0011	
XOR w A001 (Hex.)	1010 0000 0000 0001		Shift 8	0111 0001 0100 0001	1
XOR result	1000 0001 0011 1110		XOR w A001 (Hex.)	1010 0000 0000 0001	
			XOR result	1101 0001 0100 0000	
				1101 0001 0100 0000	
			CRC-16	D 1 4 0	
				(Lower) (Upper)	
Perform operations with next data (function code)			Continue from here with next data.		

Figure 5.8 CRC-16 Calculation Example

### Response Data

The drive does the CRC-16 calculation for the response message and makes sure that the data does not have errors. Make sure that the calculated value is the same value as the CRC-16 in the response message.

## ◆ Examples of Messages for Commands/Responses

The items in this section are examples of messages for commands/responses.

### ■ Read the Description of Holding Register

Uses function code 03 (Hex.) to read the contents of a maximum of 16 holding registers.

Figure 5.9 shows example messages when the drive reads status signal from the drive of slave 2, the error contents, fault contents, and frequency references.

## 5.3 MEMOBUS/Modbus Communications

Byte	Command Message		Response Message (normal)		Response Message (fault)	
		Setting Data (Hex.)		Setting Data (Hex.)		Setting Data (Hex.)
0	Slave address		Slave address		Slave address	
1	Function code		Function code		Function code	
2	Starting No.	Upper	Data Qty		Error code	
3		Lower	00	08	03	03
4	Data Qty	Upper	First storage register	Upper	CRC-16	Upper
5		Lower		00		Lower
6	CRC-16	Upper	Next storage register	Upper	-	
7		Lower		00	Lower	-
8	-		Next storage register	Upper	-	
9	-			Lower	-	
10	-		CRC-16	Upper	-	
11	-			Lower	-	
12	-				-	

Figure 5.9 Message Example When Reading the Contents of Holding Register

### ■ Loopback Test

The loopback test uses function code 08 (Hex.) and returns the command message as a response message. This test checks communication between the master and slave. The test code and data can use desired values.

Figure 5.10 shows examples of messages given out when the loopback test is done with the drive of slave 1.

Byte	Command Message		Response Message (normal)	
		Setting Data (Hex.)		Setting Data (Hex.)
0	Slave address		Slave address	
1	Function code		Function code	
2	Test code	Upper	Test code	Upper
3		Lower		Lower
4	Data	Upper	Data	Upper
5		Lower		Lower
6	CRC-16	Upper	CRC-16	Upper
7		Lower		Lower

Figure 5.10 Message Example When Doing the Loopback Test

### ■ Writing to Multiple Holding Registers

You can write the data that you set to the number of holding registers set in function code 10 (hex). You must configure the number of the holding registers and each 8 higher bits and 8 lower bits in order in the command message for the write data. You can write to a maximum of 16 holding registers.

Figure 5.11 shows example messages when you use the PLC to set Forward run in the drive of slave 1 with a 60.00 Hz frequency reference.

When you rewrite the parameter value with the write command through the *H5-11 [Comm ENTER Command Mode]* setting, you must use the Enter command to save and enable the contents of the changes. Refer to *H5-11: Comm ENTER Command Mode on page 929* and *Enter Command on page 302* for more information.

Byte	Command message		Response message (when normal)			Response message (when there is a fault)	
		Setting data (Hex.)		Setting data (Hex.)		Setting data (Hex.)	
0	Slave address		Slave address		Slave address		
1	Function code		Function code		Function code		
2	Starting No.	Upper	Starting No.	Upper	Error code		
3		Lower		Lower	CRC-16	Upper	CD
4	Data Qty	Upper	Data Qty	Upper		Lower	C1
5		Lower		Lower	-		
6	Byte No.		CRC-16	Upper	-		
7	First data	Upper		Lower	-		
8		Lower	-		-		
9	Next data	Upper	-		-		
10		Lower	-		-		
11	CRC-16	Upper	-		-		
12		Lower	-		-		

Figure 5.11 Message Example When Writing to Multiple Holding Registers

**Note:**

The number of bytes set in the command message set the data quantity  $\times 2$  during the command message. The response message uses the same formula.

### ■ Reading from More than One Holding Register/Reading the Indicated Register

The drive uses function code 5A (Hex.) to write to more than one register, then it reads the contents of four holding registers at the same time.

The function for writing to more than one register is the same as the function for function code 10 (Hex.). You can write to a maximum of 16 holding registers.

The four holding registers to be read from are specified in *H5-25 to H5-28 [Function 5A Register x Selection]*.

Table 5.6 shows example messages when you write to more than one holding register or when you read more than one command register. Table 5.6 uses this register data for the examples:

- The drive for slave 1 is set for Forward run with a frequency reference of 60.00 Hz.
- The setting in *H5-25 to H5-28* and the data in the specified holding registers are as follows.
  - *H5-25* = 0044H: *U1-05 [Motor Speed]* = 60.00 Hz (6000 = 1770H)
  - *H5-26* = 0045H: *U1-06 [Output Voltage Ref]* = 200.0 V (2000 = 07D0H)
  - *H5-27* = 0042H: *U1-03 [Output Current]* = 50% of drive rated current (100% = 8192, 50% = 4096 = 1000H)
  - *H5-28* = 0049H: *U1-10 [Input Terminal Status]* = 00H

When you rewrite the parameter value with the write command through the *H5-11 [Comm ENTER Command Mode]* setting, you must use the Enter command to save and enable the contents of the changes. Refer to *H5-11: Comm ENTER Command Mode on page 929* and *Enter Command on page 302* for more information.

Table 5.6 Message Example When Reading from More than One Holding Register/Reading the Indicated Register

Byte	Command Message		Response Message (when Normal)		Response Message (when There is a Fault)	
		Setting Data (Hex.)		Setting Data (Hex.)		Setting Data (Hex.)
0	Slave address		Slave address		Slave address	
1	Function code		Function code		Function code	

### 5.3 MEMOBUS/Modbus Communications

Byte	Command Message			Response Message (when Normal)			Response Message (when There is a Fault)		
			Setting Data (Hex.)			Setting Data (Hex.)			Setting Data (Hex.)
2	Starting No.	Upper	00	Register status		0F	Register status		0F
3		Lower	01	Data in holding register 1 selected with H5-25	Upper	17	Data in holding register 1 selected with H5-25	Upper	17
4	Data Qty	Upper	00		Lower	70		Lower	70
5		Lower	02	Data in holding register 2 selected with H5-26	Upper	07	Data in holding register 2 selected with H5-26	Upper	07
6	Byte No.		04		Lower	D0		Lower	D0
7	First data	Upper	00	Data in holding register 3 selected with H5-27	Upper	10	Data in holding register 3 selected with H5-27	Upper	10
8		Lower	01		Lower	00		Lower	00
9	Next data	Upper	17	Data in holding register 4 selected with H5-28	Upper	00	Data in holding register 4 selected with H5-28	Upper	00
10		Lower	70		Lower	00		Lower	00
11	CRC-16	Upper	4F	Starting No.	Upper	00	Error code		02
12		Lower	43		Lower	01	CRC-16	Upper	E9
13	-			Data Qty	Upper	00		Lower	6C
14	-				Lower	02	-		
15	-			CRC-16	Upper	AC	-		
16	-				Lower	D0	-		

**Note:**

The number of bytes set in the command message set the data quantity × 2 during the command message. The response message uses the same formula.

Register status	
bit 0	Data in register 1 selected with H5-25 1: Successfully read the register, 0: Register read error
bit 1	Data in register 2 selected with H5-26 1: Successfully read the register, 0: Register read error
bit 2	Data in register 3 selected with H5-27 1: Successfully read the register, 0: Register read error
bit 3	Data in register 4 selected with H5-28 1: Successfully read the register, 0: Register read error
bit 4	Not used
bit 5	Not used
bit 6	Not used
bit 7	Not used

#### ■ Reading the Contents of Non-Consecutive Holding Registers

The drive uses function code 67 (Hex.) and subfunction code 010D (Hex.) to read data with a maximum of 120 holding registers.

You must give the holding register number from which to read separately.

Table 5.7 shows example messages when you read the frequency reference and torque limit from the drive for slave 1. Table 5.7 uses these specified holding registers data for the examples.

- 0024H:U1-01 [Frequency Reference] = 60.00 Hz (6000 = 1770H)

- 0028H:U1-09 [Torque Reference] = 100.0% (1000 = 03E8H)

Table 5.7 Message Example When Reading the Contents of Non-Consecutive Holding Registers

Byte	Command Message			Response Message (when Normal)			Response Message (when There is a Fault)		
			Setting Data (Hex.)			Setting Data (Hex.)			Setting Data (Hex.)
0	Slave address		01	Slave address		01	Slave address		01
1	Function code		67	Function code		67	Function code		E7
2	Subfunction code	Upper	01	Subfunction code	Upper	01	Error code		02
3		Lower	0D		Lower	0D	CRC-16	Upper	EA
4	Data Qty	Upper	00	Byte No.	Upper	00		Lower	31
5		Lower	02		Lower	04	-		
6	Holding register 1 No.	Upper	00	Holding register 1 data	Upper	17	-		
7		Lower	24		Lower	70	-		
8	Holding register 2 No.	Upper	00	Holding register 2 data	Upper	03	-		
9		Lower	28		Lower	E8	-		
10	CRC-16	Upper	8B	CRC-16	Upper	47	-		
11		Lower	29		Lower	ED	-		

**Note:**

The number of bytes set within the response message sets twice the number of data contained in the command message. The response message uses the same formula.

## ■ Writing to Non-Consecutive Holding Registers

You can separately write the specified data to a maximum of 60 holding registers that uses function code 67 (Hex.) and subfunction code 010E (Hex.) .

You must give the holding register number from which to write separately.

Table 5.8 shows example messages when you write the frequency reference and torque limit from the drive for slave 1. Table 5.8 uses these specified holding registers data for the examples.

- 0002H: Frequency Reference = 60.00 Hz (6000 = 1770H)
- 0004H: Torque Limit = 150.0% (1500 = 05DCH)

When you rewrite the parameter value with the write command through the H5-11 [Comm ENTER Command Mode] setting, you must use the Enter command to save and enable the contents of the changes. Refer to H5-11: Comm ENTER Command Mode on page 929 and Enter Command on page 302 for more information.

Table 5.8 Message Example When Writing to Non-Consecutive Holding Registers

Byte	Command Message			Response Message (when Normal)			Response Message (when There is a Fault)		
			Setting Data (Hex.)			Setting Data (Hex.)			Setting Data (Hex.)
0	Slave address		01	Slave address		01	Slave address		01
1	Function code		67	Function code		67	Function code		E7
2	Subfunction code	Upper	01	Subfunction code	Upper	01	Error code		02
3		Lower	0E		Lower	0E	CRC-16	Upper	EA
4	Data Qty	Upper	00	Data Qty	Upper	00		Lower	31
5		Lower	02		Lower	02	-		
6	Byte No.	Upper	00	CRC-16	Upper	D5	-		
7		Lower	04		Lower	FC	-		
8	Holding register 1 No.	Upper	00	-		-			
9		Lower	02	-		-			

Byte	Command Message			Response Message (when Normal)	Response Message (when There is a Fault)
			Setting Data (Hex.)	Setting Data (Hex.)	Setting Data (Hex.)
10	Holding register 1 data	Upper	17	-	-
11		Lower	70	-	-
12	Holding register 2 No.	Upper	00	-	-
13		Lower	04	-	-
14	Holding register 2 data	Upper	05	-	-
15		Lower	DC	-	-
16	CRC-16	Upper	55	-	-
17		Lower	59	-	-

**Note:**

The number of bytes set within the command message determines the data quantity  $\times 2$  during the command message. The response message uses the same formula.

◆ **Enter Command**

When you use MEMOBUS/Modbus communications to write parameters from the PLC to the drive, the *H5-11 [Comm ENTER Command Mode]* setting sets the function to enable these parameters from the Enter command. This section gives information about the Enter command.

■ **Types of Enter Commands**

The drive supports the two Enter commands shown in [Table 5.9](#).

Write 0 to register number 0900 or 0910 (Hex.) to enable the Enter command. You can only write to these registers. If you read to these registers, it will cause an error.

**Table 5.9 Types of Enter Commands**

Register No. (Hex.)	Description
0900	When you write parameter data to the EEPROM, you will enable the data on the RAM at the same time. This process saves the parameter changes until you de-energize the drive.
0910	This updates the data on the RAM, but does not write data to the EEPROM. This process saves the parameter changes until you de-energize the drive.

**Note:**

- You can write the EEPROM to the drive a maximum of 100,000 times. Do not frequently execute the Enter command (0900 (Hex.)) that is written to EEPROM. The Enter command register is write-only. If this register is read, it will cause a Register Number Error (02 (Hex.)).
- When the command data or broadcast message is transmitted to the drive, the Enter command is not necessary.

■ **Functions of the Enter Command when Replacing a Previous Generation Drive**

When you replace a previous generation Yaskawa drive with this product, you must set the Enter command function for this product the same as the previous product. The Enter command function is different for Yaskawa G7, F7-series, and V7-series drives.

Use *H5-11* to set the Enter command function:

- When replacing G7 and F7 series drives, set *H5-11 = 0 [ENTER Command Required]*.
- When replacing V7 series drives, set *H5-11 = 1 [ENTER Command Not Required]*.
- When replacing 1000-series drives, set *H5-11* to the same value as the drive you replaced.

**Table 5.10 Enter Command Function Differences**

H5-11 Settings	H5-11 = 0	H5-11 = 1
The drive you replaced	G7, F7	V7
Time when the parameter settings are enabled	When the drive receives the Enter command from the master	When you change the parameter settings

H5-11 Settings	H5-11 = 0	H5-11 = 1
Upper and lower limit check	Checks the upper and lower limits and considers the related parameter settings.	Checks the upper and lower limit of the changed parameter only.
Default setting of related parameters	Will not change related parameter settings. You must change the parameters manually.	Automatically changes the default settings for the related parameters.
Fault detection when setting more than one parameter	Accepts and responds as usual to correct setting data if the data contains parameter setting errors. The drive discards the disabled setting data, but will not return an error message.	If there is a setting error in a parameter, the drive responds with a fault. The drive discards the data that was sent.

## ◆ Self-Diagnostics

The drive can use Self-Diagnostics to find the operation of the serial communications interface circuit. Self-Diagnostics connects the transmission terminal to the reception terminal on the control circuit. It then transmits the data sent by the drive and makes sure that the drive can communicate correctly.

Use this procedure to do Self-Diagnostics:

1. Energize the drive.
2. Set  $H1-06 = 67$  [*Terminal S6 Function Selection = Communications Test Mode*].
3. De-energize the drive.
4. Connect a jumper between control circuit terminals S6 and SN.

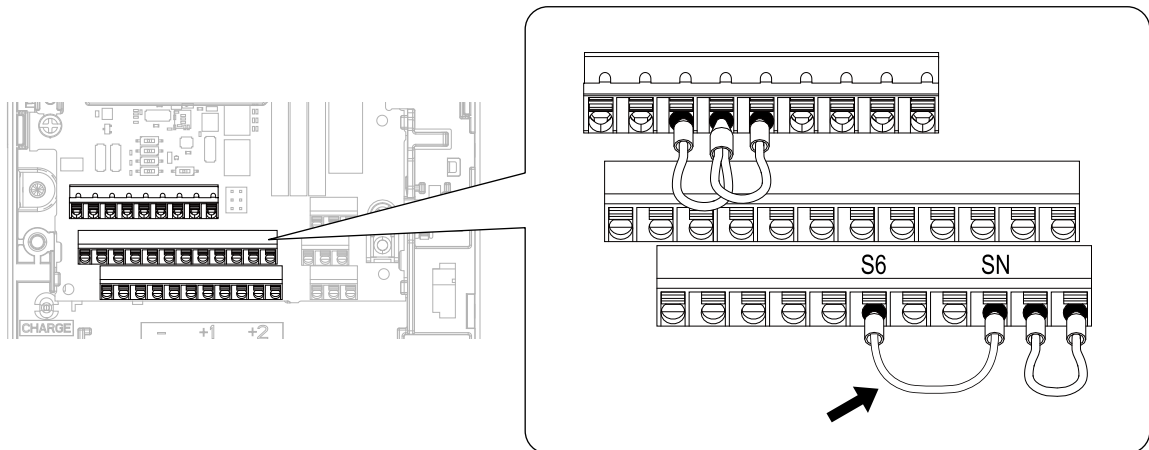


Figure 5.12 Self-Diagnostics Jumper Terminals

5. Energize the drive.
6. When normal, the keypad will show *PASS* [*MEMOBUS/Modbus Communications Test Mode Normal*]. When there is an error, the keypad will show *CE* [*MEMOBUS/Modbus Communications Error*].
7. De-energize the drive.
8. Disconnect the wire jumper between terminals S6 and SN. Set terminal S6 to its initial function.

Self-Diagnostics is complete and the drive returns to its usual function.

## ◆ Communications Data Table

[Command Data on page 303](#), [Monitor Data on page 306](#) and [Broadcast Messages on page 321](#) show the communications data. The data types are command data, monitor data, and broadcast message.

Refer to the Parameter List for parameter communications registers.

### ■ Command Data

You can read and write command data.

#### Note:

Set the reserved bit to 0. Do not write the data in the reserved register or the monitor register.

Table 5.11 MEMOBUS/Modbus Communications Command Data

Register No. (Hex.)	Description	
0000	Reserved	
0001	Run command, multi-function input command	
	bit 0	When $H5-12 = 0$ , Forward run/stop 1: Forward run, 0: Stop When $H5-12 = 1$ , run/stop 1: Run, 0: Stop
	bit 1	When $H5-12 = 0$ , Reverse run/stop 1: Reverse run, 0: Stop When $H5-12 = 1$ , Forward/Reverse run 1: Reverse, 0: Forward run
	bit 2	External Fault 1: EF0 [Option Card External Fault]
	bit 3	Fault Reset 1: Reset command
	bit 4	Multi-function input 1 When $H1-01 = 40$ [Forward RUN (2-Wire)], the multi-function input command is "ComRef." <b>Note:</b> When you switch the bit ON as ComRef, the frequency reference source changes to MEMOBUS/Modbus communications. When you connect a communication option to the drive, the frequency reference source gives priority to the communications option.
	bit 5	Multi-function input 2 When the multi-function input command is $H1-02 = 41$ [Reverse RUN (2-Wire)], bit 5 is "ComCtrl." <b>Note:</b> When you switch the bit ON as ComCtrl, the Run Command source changes to MEMOBUS/Modbus communications. When you connect a communication option to the drive, the Run Command source gives priority to the communications option.
	bit 6	Multi-function input 3
	bit 7	Multi-function input 4
	bit 8	Multi-function input 5
	bit 9	Multi-function input 6
	bit A	Multi-function input 7
	bit B	Multi-function input 8
bit C - F	Reserved	
0002	Frequency Reference	$o1-03$ [Frequency Display Unit Selection] (unsigned) sets the units.
0003	Output voltage gain	Units: 0.1 % Setting range: 20 (2.0%) to 2000 (200.0%), the default value at energize: 1000 (100.0%)
0004	Torque reference/torque limit (0.1% signed)	
0005	Torque compensation (0.1% signed)	
0006	PID setpoint (0.01% signed)	
0007	Setting for the multi-function analog monitor output terminal 1 (10 V/4000 H)	
0008	Setting for the multi-function analog monitor output terminal 2 (10 V/4000 H)	



Register No. (Hex.)	Description	
0009	MFDO setting	
	bit 0	MFDO (terminal M1-M2) 1: ON, 0: OFF
	bit 1	MFDO (terminal M3-M4) 1: ON, 0: OFF
	bit 2	MFDO (terminal M5-M6) 1: ON, 0: OFF
	bit 3 - 5	Reserved
	bit 6	1: bit 7 function is enabled
	bit 7	Fault relay output (terminal MA/MB-MC) 1: ON, 0: OFF
	bit 8 - F	Reserved
000A	Pulse train output (Units: 1/1 Hz, setting range: 0 to 32000)	
000B - 000E	Reserved	
000F	Command selection setting	
	bit 0	Reserved
	bit 1	Input for the PID setpoint 1: Enables target values from MEMOBUS/Modbus
	bit 2	Torque reference/torque limit input 1: Enables setting values from MEMOBUS/Modbus
	bit 3	Torque Compensation Input 1: Enables setting values from MEMOBUS/Modbus
	bit 4	Reserved
	bit 5	PID feedback from the MEMOBUS/Modbus 1: Enables PID feedback (15FF (Hex.)) from MEMOBUS/Modbus
	bit 6 - B	Reserved
	bit C	Terminal S5 input of broadcast message 1: Enabled, 0: Disabled
	bit D	Terminal S6 input of broadcast message 1: Enabled, 0: Disabled
	bit E	Terminal S7 input of broadcast message 1: Enabled, 0: Disabled
bit F	Terminal S8 input of broadcast message 1: Enabled, 0: Disabled	
0010 - 001A	Reserved	
001B	Analog monitor option AO-A3 analog output 1 value (10 V/4000 (Hex.))	
001C	Analog monitor option AO-A3 analog output 2 value (10 V/4000 (Hex.))	
001D	Digital output option DO-A3 output value (binary)	
001E - 001F	Reserved	
15C0	bit 0	Extended multi-function input command 1
	bit 1	Extended multi-function input command 2
	bit 2	Extended multi-function input command 3
	bit 3 - F	Reserved

## 5.3 MEMOBUS/Modbus Communications

Register No. (Hex.)	Description
3004	<p>Time Setting Setting range: 0000 to 2359 (decimal), the default value at energize: 0000 Set the hour and the minute in HHMM format.</p> <ul style="list-style-type: none"> <li>• HH: 00 to 23 (decimal)</li> <li>• MM: 00 to 59 (decimal)</li> </ul>
3005	<p>Year and Day Setting Setting range: 1600 to 9906 (decimal), the default value at energize: 1600 Set the year and the day of the week in YYDW format.</p> <ul style="list-style-type: none"> <li>• YY: the last two digits of the year from 16 to 99 (decimal)</li> <li>• DW: the day of the week <ul style="list-style-type: none"> <li>– Sunday: 00</li> <li>– Monday: 01</li> <li>– Tuesday: 02</li> <li>– Wednesday: 03</li> <li>– Thursday: 04</li> <li>– Friday: 05</li> <li>– Saturday: 06</li> </ul> </li> </ul>
3006	<p>Date Setting Setting range: 0101 to 1231 (decimal), the default value at energize: 0101 Set the month and the date in MMDD format.</p> <ul style="list-style-type: none"> <li>• MM: 01 to 12 (decimal)</li> <li>• DD: 01 to 31 (decimal)</li> </ul>
3007	<p>Set the Date Information Setting range: 0 to 8 (decimal), the default value at energize: 8 Set the values specified in 3004H to 3006H as the date and time.</p> <ul style="list-style-type: none"> <li>• Command Data: 1</li> <li>• Response Data: 0 (normal), 8 (fault)</li> </ul>

### ■ Monitor Data

You can only read monitor data.

Table 5.12 Monitor Data for MEMOBUS/Modbus Communication

Register No. (Hex.)	Description	
0020	Drive Status 1	
	bit 0	During Run 1: During run, 0: During stop
	bit 1	During Reverse 1: During reverse, 0: Forward run
	bit 2	Drive ready 1: Ready, 0: Not ready
	bit 3	Faults 1: Fault
	bit 4	Data Setting Error 1: oPExx error
	bit 5	MFDO (terminal M1-M2) 1: ON, 0: OFF
	bit 6	MFDO (terminal M3-M4) 1: ON, 0: OFF
	bit 7	MFDO (terminal M5-M6) 1: ON, 0: OFF
	bit 8 - D	Reserved
	bit E	ComRef status 1: Enabled
	bit F	ComCtrl status 1: Enabled
	0021	Fault Description 1
bit 0		oC [Overcurrent], GF [Ground Fault]
bit 1		ov [DC Bus Overvoltage]
bit 2		oL2 [Drive Overloaded]
bit 3		oH1 [Heatsink Overheat], oH2 [External Overheat (H1-XX=B)]
bit 4		rH [Braking Resistor Overheat], tr [Dynamic Braking Transistor Fault]
bit 5		Reserved
bit 6		FbL [PID Feedback Loss], FbH [Excessive PID Feedback]
bit 7		EF0 [Option Card External Fault], EF1 to EF8 [External Fault]
bit 8		CPFxx [Hardware Fault] <b>Note:</b> Includes oFx.
bit 9		oL1 [Motor Overload], oL3, L4 [Overtorque Detection 1/2], UL3, L4 [Undertorque Detection 1/2]
bit A		PGo [Encoder (PG) Feedback Loss], PGoH [Encoder (PG) Hardware Fault], oS [Overspeed], dEv [Speed Deviation]
bit B		During Uv [Undervoltage] detection
bit C		Uv1 [DC Bus Undervoltage], Uv2 [Control Power Undervoltage], Uv3 [Soft Charge Answerback Fault]
bit D		LF [Output Phase Loss], PF [Input Phase Loss]
bit E		CE [Modbus Communication Error], bUS [Option Communication Error]
bit F	oPr [Keypad Connection Fault]	

## 5.3 MEMOBUS/Modbus Communications

Register No. (Hex.)	Description	
0022	Fault Contents	
	bit 0	1: During data writing, during motor switching
	bit 1	Reserved
	bit 2	
	bit 3	1: Upper/Lower Limit Fault
	bit 4	1: Data Integrity Fault
	bit 5	1: During EEPROM writing
	bit 6	0: EEPROM writing 1: Change data only on the RAM <b>Note:</b> Enabled when <i>H5-17 = 1</i> [ <i>ENTER command response @CPU BUSY = Write to RAM Only</i> ].
	bit 7 - F	Reserved
0023	U1-01 [Frequency Reference] <b>Note:</b> <i>o1-03 [Frequency Display Unit Selection]</i> sets the units.	
0024	U1-02 [Output Frequency] <b>Note:</b> <i>o1-03 [Frequency Display Unit Selection]</i> sets the units.	
0025	U1-06 [Output Voltage Ref] (units: 0.1 V) <b>Note:</b> Use <i>H5-10 [Modbus Register 0025H Unit Sel]</i> to change the setting unit.	
0026	U1-03 [Output Current] (units: 0.1 A)	
0027	U1-08 [Output Power]	
0028	U1-09 [Torque Reference]	
0029	Fault Description 2	
	bit 0	Reserved
	bit 1	GF [Ground Fault]
	bit 2	PF [Input Phase Loss]
	bit 3	LF [Output Phase Loss]
	bit 4	rH [Braking Resistor Overheat]
	bit 5	Reserved
	bit 6	oH4 [Motor Overheat Fault (PTC Input)]
	bit 7 - F	Reserved

Register No. (Hex.)	Description	
002A	Minor Fault Description 1	
	bit 0 - 1	Reserved
	bit 2	EF [FWD/REV Run Command Input Error]
	bit 3	bb [Baseblock]
	bit 4	oL3 [Overtorque 1]
	bit 5	oH [Heatsink Overheat]
	bit 6	ov [DC Bus Overvoltage]
	bit 7	Uv [Undervoltage]
	bit 8	FAn [Internal Fan Fault]
	bit 9	CE [Modbus Communication Error]
	bit A	bUS [Option Communication Error]
	bit B	UL3/UL4 [Undertorque Detection 1/2]
	bit C	oH3 [Motor Overheat (PTC Input)]
	bit D	FbL [PID Feedback Loss], FbH [Excessive PID Feedback]
	bit E	Reserved
bit F	CALL [Serial Comm Transmission Error]	
002B	U1-10 [Input Terminal Status]	
	bit 0	1: Control circuit terminal S1 ON
	bit 1	1: Control circuit terminal S2 ON
	bit 2	1: Control circuit terminal S3 ON
	bit 3	1: Control circuit terminal S4 ON
	bit 4	1: Control circuit terminal S5 ON
	bit 5	1: Control circuit terminal S6 ON
	bit 6	1: Control circuit terminal S7 ON
	bit 7	1: Control circuit terminal S8 ON
	bit 8 - F	Reserved

### 5.3 MEMOBUS/Modbus Communications

Register No. (Hex.)	Description	
002C	Drive Status 2	
	bit 0	During Run 1: During run
	bit 1	During zero speed 1: During zero speed
	bit 2	Speed agreement 1: During agreement
	bit 3	User-defined speed agreement 1: During agreement
	bit 4	Frequency Detection 1 1: Output frequency $\leq$ L4-01
	bit 5	Frequency Detection 2 1: Output frequency $\geq$ L4-01
	bit 6	Drive ready 1: Run ready
	bit 7	During low voltage detection 1: During detection
	bit 8	During baseblock 1: Drive output during baseblock
	bit 9	Frequency reference mode 1: No communication option, 0: Communication option
	bit A	Run command mode 1: No communication option, 0: Communication option
	bit B	During overtorque/undertorque 1, 2 detection
	bit C	Frequency reference loss 1: Loss
	bit D	Restart Enabled 1: Restart Enabled
	bit E	Faults 1: Fault generated
bit F	MEMOBUS/Modbus communications timeout 1: At Timeout	
002D	U1-11 [Output Terminal Status]	
	bit 0	MFDO (terminal M1-M2) 1: ON, 0: OFF
	bit 1	MFDO (terminal M3-M4) 1: ON, 0: OFF
	bit 2	MFDO (terminal M5-M6) 1: ON, 0: OFF
	bit 3 - 6	Reserved
	bit 7	Fault relay output (terminal MA/MB-MC) 1: ON, 0: OFF
	bit 8 - F	Reserved
002E	Reserved	
002F	Frequency reference bias (Up 2/Down 2 function) (Units: 0.1%)	
0030	Reserved	
0031	U1-07 [DC Bus Voltage] (unit: 1 V)	
0032	U1-09 [Torque Reference] (unit: 1%)	

Register No. (Hex.)	Description	
0033	Reserved	
0034	Product code 1 [ASCII], product type (GA700 =0A)	
0035	Product code 2 [ASCII], region	
0036 - 0037	Reserved	
0038	PID Feedback: Unsigned, input is equivalent to 100%/maximum output frequency (Units:0.1%)	
0039	PID Input: Signed, $\pm 100\%$ / $\pm$ maximum output frequency (Units:0.1%)	
003A	PID Output: Signed, $\pm 100\%$ / $\pm$ maximum output frequency (Units:0.1%)	
003B - 003C	Reserved	
003D	Communications error description <b>Note:</b> The drive saves the description of the communications error until you reset the fault.	
	bit 0	CRC Error
	bit 1	Data Length Error
	bit 2	Reserved
	bit 3	Parity Error
	bit 4	Overflow Error
	bit 5	Framing Error
	bit 6	Timeout
bit 7 - F	Reserved	
003E	Output frequency	Units: $\text{min}^{-1}$ or r/min <b>Note:</b> Set E2-04, E4-04, E5-04, E9-08 [Motor Pole Count].
003F		0.01 % units
0040 - 004A	Used with U1-xx [Operation Status Monitors]. Refer to the U Monitor for parameter details.	
004B	U1-12 [Drive Status]	
	bit 0	1: During run
	bit 1	1: During zero speed
	bit 2	1: During reverse
	bit 3	1: During reset signal input
	bit 4	1: During speed agreement
	bit 5	1: Drive operation ready
	bit 6	1: Minor Fault
	bit 7	1: Fault
	bit 8	1: oPExx [Operation Error] generation
	bit 9	1: Recovery from momentary power loss, 0: Power recovery
	bit A	1: Motor 2 Selection
	bit B	Reserved
bit E	ComRef status/ NetRef status	
bit F	ComCtrl status/ NetCtrl status	
004C - 007E	Use with U1-xx, U4-xx, U5-xx, U6-xx [Monitors]. Refer to "U2: Fault Trace" and "U3: Fault History" for details.	
007F	Minor fault code (Refer to "Minor fault description" for more information on the minor fault codes.)	
0080 - 0097	Use with U2-xx, U3-xx [Monitors]. Refer to "U Monitor" for details, and refer to "Fault Trace/Fault History Descriptions" for details on register values.	
0098 - 0099	U4-01 [Cumulative Ope Time] (Ex.) When U4-01 [Cumulative Ope Time] is 12345, 0098 (Hex.) = 1234 and 0099 (Hex.) = 5.	

### 5.3 MEMOBUS/Modbus Communications

Register No. (Hex.)	Description	
009A - 009B	U4-03 [Cooling Fan Ope Time] (Ex.) When U4-03 [Cooling Fan Ope Time] is 12345, 009A (Hex.) = 1234 and 009B (Hex.) = 5.	
009C - 00AA	Reserved	
00AB	Drive rated current <b>Note:</b> The unit of display is different for different models. 2004 to 2042, 4002 to 4023: 0.01 A 2056 to 2415, 4031 to 4675: 0.1 A	
00AC	U1-05 [Motor Speed]	Units: min <sup>-1</sup> or r/min <b>Note:</b> Set E2-04, E4-04, E5-04, E9-08 [Motor Pole Count].
00AD		Units: 0.01%
00AE, 00AF	Reserved	
	Option codes connected to CN5-A	The drive stores option codes in the register. AI-A3 = 0003 (Hex.) AO-A3 = 0004 (Hex.) DI-A3 = 0001 (Hex.) DO-A3 = 0002 (Hex.) PG-B3 = 0011 (Hex.) PG-F3 = 0021 (Hex.) PG-RT3 = 0023 (Hex.) PG-X3 = 0012 (Hex.) SI-C3 = 5343 (Hex.) SI-EM3 = 1005 (Hex.) SI-EN3 = 1006 (Hex.) SI-ET3 = 1004 (Hex.) SI-N3 = 534E (Hex.) SI-P3 = 5350 (Hex.) SI-S3 = 5353 (Hex.) SI-T3 = 5354 (Hex.) SI-W3 = 1003 (Hex.)
00B1	Reserved	
00B2	Option codes connected to CN5-B	
00B3	Option codes connected to CN5-C	
00B4	Reserved	
00B5	U1-16 [SFS Output Frequency]	Units: min <sup>-1</sup> or r/min <b>Note:</b> Set E2-04, E4-04, E5-04, E9-08 [Motor Pole Count].
00B6		Units: 0.01%
00B7	Frequency reference monitor	Units: min <sup>-1</sup> or r/min <b>Note:</b> Set E2-04, E4-04, E5-04, E9-08 [Motor Pole Count].
00B8		Units: 0.01%
00B9 - 00BE	Reserved	
00BF	Operation error number xx of oPExx is displayed.	



Register No. (Hex.)	Description	
00C0	Fault Description 3	
	bit 0	Reserved
	bit 1	Uv1 [DC Bus Undervoltage]
	bit 2	Uv2 [Control Power Undervoltage]
	bit 3	Uv3 [Soft Charge Answerback Fault]
	bit 4	SC [Short Circuit/IGBT Failure]
	bit 5	GF [Ground Fault]
	bit 6	oC [Overcurrent]
	bit 7	ov [DC Bus Overvoltage]
	bit 8	oH [Heatsink Overheat]
	bit 9	oH1 [Heatsink Overheat]
	bit A	oL1 [Motor Overload]
	bit B	oL2 [Drive Overloaded]
	bit C	oL3 [Overtorque Detection 1]
	bit D	oL4 [Overtorque Detection 2]
	bit E	rr [Dynamic Braking Transistor]
bit F	rH [Braking Resistor Overheat]	
00C1	Fault Description 4	
	bit 0	EF3 [External Fault (Terminal S3)]
	bit 1	EF4 [External Fault (Terminal S4)]
	bit 2	EF5 [External Fault (Terminal S5)]
	bit 3	EF6 [External Fault (Terminal S6)]
	bit 4	EF7 [External Fault (Terminal S7)]
	bit 5	EF8 [External Fault (Terminal S8)]
	bit 6	FAn [Internal Fan Fault]
	bit 7	oS [Overspeed]
	bit 8	dEv [Speed Deviation]
	bit 9	PGo [Encoder (PG) Feedback Loss]
	bit A	PF [Input Phase Loss]
	bit B	LF [Output Phase Loss]
	bit C	oH3 [Motor Overheat (PTC Input)]
	bit D	oPr [Keypad Connection Fault]
	bit E	Err [EEPROM Write Error]
bit F	oH4 [Motor Overheat Fault (PTC Input)]	

## 5.3 MEMOBUS/Modbus Communications

Register No. (Hex.)	Description	
00C2	Fault Description 5	
	bit 0	CE [Modbus Communication Error]
	bit 1	bUS [Option Communication Error]
	bit 2 - 3	Reserved
	bit 4	CF [Control Fault]
	bit 5	SvE [Zero Servo Fault]
	bit 6	EF0 [Option Card External Fault]
	bit 7	FbL [PID Feedback Loss]
	bit 8	UL3 [Undertorque Detection 1]
	bit 9	UL4 [Undertorque Detection 2]
	bit A	oL7 [High Slip Braking Overload]
	bit B - E	Reserved
	bit F	Hardware Fault (includes <i>oFx</i> fault)
00C3	Fault Description 6	
	bit 0	Reserved
	bit 1	dv1 [Z Pulse Fault]
	bit 2	dv2 [Z Pulse Noise Fault Detection]
	bit 3	dv3 [Inversion Detection]
	bit 4	dv4 [Inversion Prevention Detection]
	bit 5	LF2 [Output Current Imbalance]
	bit 6	STPo [Motor Step-Out Detected]
	bit 7	PGoH [Encoder (PG) Hardware Fault]
	bit 8	E5 [MECHATROLINK Watchdog Timer Err]
	bit 9	Reserved
	bit A	SEr [Speed Search Retries Exceeded]
	bit B - F	Reserved
00C4	Fault Description 7	
	bit 0	FbH [Excessive PID Feedback]
	bit 1	EF1 [External Fault (Terminal S1)]
	bit 2	EF2 [External Fault (Terminal S2)]
	bit 3	oL5 [Mechanical Weakening Detection 1]
	bit 4	UL5 [Mechanical Weakening Detection 2]
	bit 5	CoF [Current Offset Fault]
	bit 6 - 7	Reserved
	bit 8	dWFL [DriveWorksEZ Fault]
	bit 9	dWF1 [EEPROM Memory DWEZ Data Error]
	bit A - C	Reserved
	bit D	rF [Braking Resistor Fault]
	bit E	boL [Braking Transistor Overload Fault]
bit F	Reserved	

Register No. (Hex.)	Description	
00C5	Fault Description 8	
	bit 0	LSo [LSo Fault]
	bit 1	nSE [Node Setup Error]
	bit 2 - 9	Reserved
	bit A	dv7 [Polarity Judge Timeout]
	bit B - D	Reserved
	bit E	LF3 [Output Phase Loss 3]
	bit F	UnbC [Current Imbalance]
00C6	Fault Description 9	
	bit 0	Uv4 [Gate Drive Board Power Supply Voltage Low]
	bit 1 - F	Reserved
00C7	Reserved	
00C8	Minor Fault Description 2	
	bit 0	Uv [Undervoltage]
	bit 1	ov [DC Bus Overvoltage]
	bit 2	oH [Heatsink Overheat]
	bit 3	Drive Overheat Alarm (oH2)
	bit 4	oL3 [Overtorque 1]
	bit 5	oL4 [Overtorque 2]
	bit 6	EF [FWD/REV Run Command Input Error]
	bit 7	bb [Baseblock]
	bit 8	EF3 [External Fault (Terminal S3)]
	bit 9	EF4 [External Fault (Terminal S4)]
	bit A	EF5 [External Fault (Terminal S5)]
	bit B	EF6 [External Fault (Terminal S6)]
	bit C	EF7 [External Fault (Terminal S7)]
	bit D	EF8 [External Fault (Terminal S8)]
	bit E	FAn [Internal Fan Fault]
bit F	oS [Overspeed]	

### 5.3 MEMOBUS/Modbus Communications

Register No. (Hex.)	Description	
00C9	Minor Fault Description 3	
	bit 0	dEv [Speed Deviation]
	bit 1	PGo [Encoder (PG) Feedback Loss]
	bit 2	oPr [Keypad Connection Fault]
	bit 3	CE [Modbus Communication Error]
	bit 4	bUS [Option Communication Error]
	bit 5	CALL [Serial Comm Transmission Error]
	bit 6	oL1 [Motor Overload]
	bit 7	oL2 [Drive Overloaded]
	bit 8	Reserved
	bit 9	EF0 [Option Card External Fault]
	bit A	rUn [Motor Switch during Run]
	bit B	Reserved
	bit C	CALL [Serial Comm Transmission Error]
	bit D	UL3 [Undertorque Detection 1]
	bit E	UL4 [Undertorque Detection 2]
bit F	SE [Modbus Test Mode Error]	
00CA	Minor Fault Description 4	
	bit 0	Reserved
	bit 1	oH3 [Motor Overheat (PTC Input)]
	bit 2 - 5	Reserved
	bit 6	FbL [PID Feedback Loss]
	bit 7	FbH [Excessive PID Feedback]
	bit 8	Reserved
	bit 9	dnE [Drive Disabled]
	bit A	PGoH [Encoder (PG) Hardware Fault]
	bit B - F	Reserved
00CB	Minor Fault Description 5	
	bit 0	E5 [MECHATROLINK Watchdog Timer Err]
	bit 1	AEr [Station Address Setting Error]
	bit 2	CyC [MECHATROLINK CommCycleSettingErr]
	bit 3	HCA [High Current Alarm]
	bit 4	LT-1 [Cooling Fan Maintenance Time]
	bit 5	LT-2 [Capacitor Maintenance Time]
	bit 6 - 7	Reserved
	bit 8	EF1 [External Fault (Terminal S1)]
	bit 9	EF2 [External Fault (Terminal S2)]
	bit A	SToF [Safe Torque OFF Hardware]
	bit B	STo [Safe Torque OFF]
	bit C	oL5 [Mechanical Weakening Detection 1]
	bit D	UL5 [Mechanical Weakening Detection 2]
bit E - F	Reserved	

Register No. (Hex.)	Description	
00CC	Minor Fault Description 6	
	bit 0	Reserved
	bit 1	TrPC [IGBT Maintenance Time (90%)]
	bit 2	LT-3 [SoftChargeBypassRelay MainteTime]
	bit 3	LT-4 [IGBT Maintenance Time (50%)]
	bit 4	boL [Braking Transistor Overload]
	bit 5 - 7	Reserved
	bit 8	dWAL [DriveWorksEZ Fault]
bit 9 - F	Reserved	
00CD - 00CF	Reserved	
00D0	CPF Contents 1	
	bit 0 - 1	Reserved
	bit 2	CPF02 [A/D Conversion Error]
	bit 3	CPF03 [Control Board Connection Error]
	bit 4 - 5	Reserved
	bit 6	CPF06 [EEPROM Memory Data Error]
	bit 7	CPF07 [Terminal Board Connection Error]
	bit 8	CPF08 [Terminal Board Connection Error]
	bit 9	Reserved
	bit A	CPF10 [ASIC Verify Fault]
	bit B	CPF11 [RAM Fault]
	bit C	CPF12 [FLASH Memory Fault]
	bit D	CPF13 [Watchdog Circuit Exception]
	bit E	CPF14 [Control Circuit Fault]
bit F	Reserved	
00D1	CPF Contents 2	
	bit 0	CPF16 [Clock Fault]
	bit 1	CPF17 [Timing Fault]
	bit 2	CPF18 [Control Circuit Fault]
	bit 3	CPF19 [Control Circuit Fault]
	bit 4	CPF20 [Control Circuit Error]
	bit 5	CPF21 [Control Circuit Error]
	bit 6	CPF22 [Hybrid IC Error]
	bit 7	CPF23 [Control Board Connection Error]
	bit 8	CPF24 [Drive Unit Signal Fault]
	bit 9	CPF25 [Terminal Board not Connected]
	bit A	CPF26 [BB Circuit Error]
	bit B	CPF27 [PWM Set Reg Error]
	bit C	CPF28 [PWM Pattern Error]
	bit D	CPF29 [On-Delay Error]
	bit E	CPF30 [BB On Error]
bit F	CPF31 [ASIC Code Error]	

## 5.3 MEMOBUS/Modbus Communications

Register No. (Hex.)	Description	
00D2	CPF Contents 3	
	bit 0	CPF32 [ASIC Startup Error]
	bit 1	CPF33 [Watch-dog Error]
	bit 2	CPF34 [Power/Clock Error]
	bit 3	CPF35 [Ext A/D Conv Error]
	bit 4	CPU36 [CPU-ASIC Communication Error]
	bit 5	CPU37 [CPU-ASIC Communication Error]
	bit 6	CPU38 [EEPROM Data Error]
	bit 7	CPU39 [CPU-ASIC Communication Error]
	bit 8	CPF40 [Control Circuit Error]
	bit 9	CPF41 [EEPROM Memory Data Error]
	bit A	CPF42 [EEPROM Memory Data Error]
	bit B	CPF43 [EEPROM Memory Data Error]
	bit C	CPF44 [EEPROM Memory Data Error]
	bit D	CPF45 [EEPROM Memory Data Error]
	bit E - F	Reserved
00D3 - 00D7	Reserved	
00D8	oFA0x Description (CN5-A)	
	bit 0	oFA00 [Option Not Compatible with Port]
	bit 1	oFA01 [Option Fault/Connection Error]
	bit 2 - 4	Reserved
	bit 5	oFA05 [Option A/D Error]
	bit 6	oFA06 [Option Communication Error]
	bit 7 - F	Reserved
00D9	oFA1x Description (CN5-A)	
	bit 0	oFA10 [Option RAM Error]
	bit 1	oFA11 [Option Ope Mode Error]
	bit 2	oFA12 [Drive Receive CRC Error]
	bit 3	oFA13 [Drive Receive Frame Error]
	bit 4	oFA14 [Drive Receive Abort Error]
	bit 5	oFA15 [Option Receive CRC Error]
	bit 6	oFA16 [Option Receive Frame Error]
	bit 7	oFA17 [Option Receive Abort Error]
bit 8 - F	Reserved	
00DA	Reserved	

Register No. (Hex.)	Description	
00DB	oFA3x Description (CN5-A)	
	bit 0	oFA30 [COM ID Error]
	bit 1	oFA31 [Type Code Error]
	bit 2	oFA32 [SUM Check Error]
	bit 3	oFA33 [Option Receive Time Over]
	bit 4	oFA34 [Memobus Time Over]
	bit 5	oFA35 [Drive Receive Time Over 1]
	bit 6	oFA36 [CI Check Error]
	bit 7	oFA37 [Drive Receive Time Over 2]
	bit 8	oFA38 [Control Reference Error]
	bit 9	oFA39 [Drive Receive Time Over 3]
	bit A	oFA40 [CtrlResSel 1Err]
	bit B	oFA41 [Drive Receive Time Over 4]
	bit C	oFA42 [CtrlResSel 2Err]
	bit D	oFA43 [Drive Receive Time Over 5]
bit E - F	Reserved	
00DC	oFb0x Description (CN5-B)	
	bit 0	oFb00 [Option Not Compatible with Port]
	bit 1	oFb01 [Option Fault/Connection Error]
	bit 2	oFb02 [Duplicate Options]
	bit 3 - 4	Reserved
	bit 5	oFb05 [Option A/D Error]
	bit 6	oFb06 [Option Communication Error]
bit 7 - F	Reserved	
00DD	oFb1x Description (CN5-B)	
	bit 0	oFb10 [Option RAM Error]
	bit 1	oFb11 [Option Ope Mode Error]
	bit 2	oFb12 [Drive Receive CRC Error]
	bit 3	oFb13 [Drive Receive Frame Error]
	bit 4	oFb14 [Drive Receive Abort Error]
	bit 5	oFb15 [Option Receive CRC Error]
	bit 6	oFb16 [Option Receive Frame Error]
	bit 7	oFb17 [Option Receive Abort Error]
bit 8 - F	Reserved	
00DE - 00DF	Reserved	

### 5.3 MEMOBUS/Modbus Communications

Register No. (Hex.)	Description	
00E0	oFb3x Description (CN5-B)	
	bit 0	oFb30 [COM ID Error]
	bit 1	oFb31 [Type Code Error]
	bit 2	oFb32 [SUM Check Error]
	bit 3	oFb33 [Option Receive Time Over]
	bit 4	oFb34 [Memobus Time Over]
	bit 5	oFb35 [Drive Receive Time Over 1]
	bit 6	oFb36 [CI Check Error]
	bit 7	oFb37 [Drive Receive Time Over 2]
	bit 8	oFb38 [Control Reference Error]
	bit 9	oFb39 [Drive Receive Time Over 3]
	bit A	oFb40 [CtrlResSel 1Err]
	bit B	oFb41 [Drive Receive Time Over 4]
	bit C	oFb42 [CtrlResSel 2Err]
	bit D	oFb43 [Drive Receive Time Over 5]
bit E - F	Reserved	
00E1	oFC0x Description (CN5-C)	
	bit 0	oFC00 [Option Not Compatible with Port]
	bit 1	oFC01 [Option Fault/Connection Error]
	bit 2	oFC02 [Duplicate Options]
	bit 3 - 4	Reserved
	bit 5	oFC05 [Option A/D Error]
	bit 6	oFC06 [Option Communication Error]
bit 7 - F	Reserved	
00E2	oFC1x Description (CN5-C)	
	bit 0	oFC10 [Option RAM Error]
	bit 1	oFC11 [Option Ope Mode Error]
	bit 2	oFC12 [Drive Receive CRC Error]
	bit 3	oFC13 [Drive Receive Frame Error]
	bit 4	oFC14 [Drive Receive Abort Error]
	bit 5	oFC15 [Option Receive CRC Error]
	bit 6	oFC16 [Option Receive Frame Error]
	bit 7	oFC17 [Option Receive Abort Error]
bit 8 - F	Reserved	
00E3	Reserved	
00E4	oFC5x Description (CN5-C)	
	bit 0	oFC50 [Encoder Option A/D Conv Error]
	bit 1	oFC51 [EncOpAnlgCrctErr]
	bit 2	oFC52 [Encoder Option Comm Timeout]
	bit 3	oFC53 [Encoder Option Comm Data Fault]
	bit 4	oFC54 [Encoder Error]
	bit 5	oFC55 [Resolver Error]
bit 6 - F	Reserved	



Register No. (Hex.)	Description	
00E5	Minor Fault Description 9	
	bit 0	EP24v [External Power 24V Supply]
	bit 1 - 3	Reserved
	bit 4	bAT [Keypad Battery Low Voltage]
	bit 5	Reserved
	bit 6	CP1 [Comparator 1 Limit Error]
	bit 7	CP2 [Comparator 2 Limit Error]
	bit 8	TiM [Keypad Time Not Set]
	bit 9	bCE [Bluetooth Communication Error]
bit A - F	Reserved	
00E6 - 00E9	Reserved	
00EA	Fault Description 11	
	bit 0	TiM [Keypad Time Not Set]
	bit 1	bAT [Keypad Battery Low Voltage]
	bit 2- D	Reserved
	bit E	SCF [Safety Circuit Fault]
bit F	Reserved	
00EB - 00ED	Reserved	
00EE	Fault Description 12	
	bit 0 - 2	Reserved
	bit 3	CP1 [Comparator 1 Limit Error]
	bit 4	CP2 [Comparator 2 Limit Error]
	bit 5	bCE [Bluetooth Communication Error]
bit 6 - F	Reserved	
00EF - 00FA	Reserved	
00FB	Output current <b>Note:</b> The unit of display is different for different models. 2004 to 2042, 4002 to 4023: 0.01 A 2056 to 2415, 4031 to 4675: 0.1 A	

### ■ Broadcast Messages

Broadcast messages are available as read-only.

The undefined bit signal in the broadcast operation signal uses the local data signal.

Table 5.13 Broadcast Messages for MEMOBUS/Modbus Communication

Register No. (Hex.)	Description	
0001	Operation signal	
	bit 0	Run command 1: Run, 0: Stop
	bit 1	Reverse run command 1: Reverse, 0: Forward run
	bit 2 - 3	Reserved
	bit 4	External fault 1: EF0 [Option Card External Fault]
	bit 5	Fault Reset 1: Reset command
	bit 6 - B	Reserved
	bit C	MFDI terminal S5 input
	bit D	MFDI terminal S6 input
	bit E	MFDI terminal S7 input
	bit F	MFDI terminal S8 input
0002	Frequency reference	30000/100%

### ■ Fault Trace/Fault History Contents

Table 5.14 lists the fault codes that the commands from monitors [*U2-xx*, *U3-xx*] read.

Table 5.14 Fault Trace/Fault History Contents

Fault Code (Hex.)	Name	Fault Code (Hex.)	Name
0002	Uv1 [DC Bus Undervoltage]	0017	FAn [Internal Fan Fault]
0003	Uv2 [Control Power Undervoltage]	0018	oS [Overspeed]
0004	Uv3 [Soft Charge Answerback Fault]	0019	dEv [Speed Deviation]
0005	SC [Short Circuit/IGBT Failure]	001A	PGo [Encoder (PG) Feedback Loss]
0006	GF [Ground Fault]	001B	PF [Input Phase Loss]
0007	oC [Overcurrent]	001C	LF [Output Phase Loss]
0008	ov [Overvoltage]	001D	oH3 [Motor Overheat (PTC Input)]
0009	oH [Heatsink Overheat]	001E	oPr [Keypad Connection Fault]
000A	oH1 [Heatsink Overheat]	001F	Err [EEPROM Write Error]
000B	oL1 [Motor Overload]	0020	oH4 [Motor Overheat Fault (PTC Input)]
000C	oL2 [Drive Overload]	0021	CE [Modbus Communication Error]
000D	oL3 [Overtorque Detection 1]	0022	bUS [Option Communication Error]
000E	oL4 [Overtorque Detection 2]	0025	CF [Control Fault]
000F	rr [Dynamic Braking Transistor Fault]	0026	SvE [Zero Servo Fault]
0010	rH [Braking Resistor Overheat]	0027	EF0 [Option Card External Fault]
0011	EF3 [External Fault (Terminal S3)]	0028	FbL [PID Feedback Loss]
0012	EF4 [External Fault (Terminal S4)]	0029	UL3 [Undertorque Detection 1]
0013	EF5 [External Fault (Terminal S5)]	002A	UL4 [Undertorque Detection 2]
0014	EF6 [External Fault (Terminal S6)]	002B	oL7 [High Slip Braking Overload]
0015	EF7 [External Fault (Terminal S7)]	0030	Includes oFx Fault [Hardware Fault]
0016	EF8 [External Fault (Terminal S8)]	0032	dv1 [Z Pulse Fault]

Fault Code (Hex.)	Name	Fault Code (Hex.)	Name
0033	dv2 [Z Pulse Noise Fault Detection]	0098	CPF23 [Control Board Connection Error]
0034	dv3 [Inversion Detection]	0099	CPF24 [Drive Unit Signal Fault]
0035	dv4 [Inversion Prevention Detection]	009A	CPF25 [Terminal Board not Connected]
0036	LF2 [Output Current Imbalance]	009B	CPF26 [BB Circuit Error]
0037	STPo [Motor Step-Out Detected]	009C	CPF27 [PWM Set Reg Error]
0038	PGoH [Encoder (PG) Hardware Fault]	009D	CPF28 [PWM Pattern Error]
0039	E5 [MECHATROLINK Watchdog Timer Err]	009E	CPF29 [On-Delay Error]
003B	SEr [Speed Search Retries Exceeded]	009F	CPF30 [BB On Error]
0041	FbH [Excessive PID Feedback]	00A0	CPF31 [ASIC Code Error]
0042	EF1 [External Fault (Terminal S1)]	00A1	CPF32 [ASIC Startup Error]
0043	EF2 [External Fault (Terminal S2)]	00A2	CPF33 [Watch-dog Error]
0044	oL5 [Mechanical Weakening Detection 1]	00A3	CPF34 [Power/Clock Error]
0045	UL5 [Mechanical Weakening Detection 2]	00A4	CPF35 [Ext A/D Conv Error]
0046	CoF [Current Offset Fault]	00A5	CPF36 [ASIC COM Error]
0049	dWFL [DriveWorksEZ Fault]	00A6	CPF37 [ASIC COM Error]
004A	dWF1 [EEPROM Memory DWEZ Data Error]	00A7	CPF38 [EEPROM Data Error]
004B	dWF2 [DriveWorksEZ Fault 2]	00A9	CPF40 [Control Circuit Error]
004C	dWF3 [DriveWorksEZ Fault 3]	00AA	CPF41 [Control Circuit Error]
004E	rF [Braking Resistor Fault]	00AB	CPF42 [Control Circuit Error]
004F	boL [Braking Transistor Overload Fault]	00AC	CPF43 [Control Circuit Error]
0051	LSo [Low Speed Motor Step-Out]	00AD	CPF44 [Control Circuit Error]
0052	nSE [Node Setup Error]	00AE	CPF45 [Control Circuit Error]
005B	dv7 [Polarity Judge Timeout]	0101	oFA00 [Option Not Compatible with Port]
005F	LF3 [Output Phase Loss 3]	0102	oFA01 [Option Fault/Connection Error]
0060	UnbC [Current Imbalance]	0106	oFA05 [Option A/D Error]
0061	Uv4 [Gate Drive Board Power Supply Voltage Low]	0107	oFA06 [Option Communication Error]
0083	CPF02 [A/D Conversion Error]	0111	oFA10 [Option RAM Error]
0084	CPF03 [Control Board Connection Error]	0112	oFA11 [Option Ope Mode Error]
0087	CPF06 [EEPROM Memory Data Error]	0113	oFA12 [Drive Receive CRC Error]
0088	CPF07 [Terminal Board Connection Error]	0114	oFA13 [Drive Receive Frame Error]
0089	CPF08 [Terminal Board Connection Error]	0115	oFA14 [Drive Receive Abort Error]
008C	CPF11 [RAM Fault]	0116	oFA15 [Option Receive CRC Error]
008D	CPF12 [FLASH Memory Fault]	0117	oFA16 [Option Receive Frame Error]
008E	CPF13 [Watchdog Circuit Exception]	0118	oFA17 [Option Receive Abort Error]
008F	CPF14 [Control Circuit Fault]	0131	oFA30 [COM ID Error]
0091	CPF16 [Clock Fault]	0132	oFA31 [Type Code Error]
0092	CPF17 [Timing Fault]	0133	oFA32 [SUM Check Error]
0093	CPF18 [Control Circuit Fault]	0134	oFA33 [Option Receive Time Over]
0094	CPF19 [Control Circuit Fault]	0135	oFA34 [Memobus Time Over]
0095	CPF20 [Control Circuit Error]	0136	oFA35 [Drive Receive Time Over 1]
0096	CPF21 [Control Circuit Error]	0137	oFA36 [CI Check Error]
0097	CPF22 [Hybrid IC Error]	0138	oFA37 [Drive Receive Time Over 2]

Fault Code (Hex.)	Name	Fault Code (Hex.)	Name
0139	oFA38 [Control Reference Error]	023B	oFb40 [Control Response Selection 1 Error]
013A	oFA39 [Drive Receive Time Over 3]	023C	oFb41 [Drive Timeout Waiting for Response]
013B	oFA40 [CtrlResSel 1Err]	023D	oFb42 [Control Response Selection 2 Error]
013C	oFA41 [Drive Receive Time Over 4]	023E	oFb43 [Drive Timeout Waiting for Response]
013D	oFA42 [CtrlResSel 2Err]	0301	oFC00 [Option Not Compatible with Port]
013E	oFA43 [Drive Receive Time Over 5]	0302	oFC01 [Option Fault/Connection Error]
0201	oFb00 [Option Not Compatible with Port]	0303	oFC02 [Duplicate Options]
0202	oFB01 [Option Fault/Connection Error]	0306	oFC05 [Option A/D Error]
0203	oFb02 [Duplicate Options]	0307	oFC06 [Option Communication Error]
0206	oFb05 [Option A/D Error]	0311	oFC10 [Option RAM Error]
0207	oFb06 [Option Communication Error]	0312	oFC11 [Option Ope Mode Error]
0211	oFb10 [Option RAM Error]	0313	oFC12 [Drive Receive CRC Error]
0212	oFb11 [Option Ope Mode Error]	0314	oFC13 [Drive Receive Frame Error]
0213	oFb12 [Drive Receive CRC Error]	0315	oFC14 [Drive Receive Abort Error]
0214	oFb13 [Drive Receive Frame Error]	0316	oFC15 [Option Receive CRC Error]
0215	oFb14 [Drive Receive Abort Error]	0317	oFC16 [Option Receive Frame Error]
0216	oFb15 [Option Receive CRC Error]	0318	oFC17 [Option Receive Abort Error]
0217	oFb16 [Option Receive Frame Error]	0351	oFC50 [Encoder Option A/D Conv Error]
0218	oFb17 [Option Receive Abort Error]	0352	oFC51 [EncOpAnlgCrctErr]
0231	oFb30 [Comm. ID Error]	0353	oFC52 [Encoder Option Comm Timeout]
0232	oFb31 [Model Code Error]	0354	oFC53 [Encoder Option Comm Data Fault]
0233	oFb32 [Checksum Error]	0355	oFC54 [Encoder Error]
0234	oFb33 [Comm. Option Timeout Waiting for Response]	0356	oFC55 [Resolver Error]
0235	oFb34 [MEMOBUS/Modbus Ccommunications Timeout]	0401	TiM [Keypad Time Not Set]
0236	oFb35 [Drive Timeout Waiting for Response]	0402	bAT [Keypad Battery Low Voltage]
0237	oFb36 [CI Check Error]	040F	SCF [Safety Circuit Fault]
0238	oFb37 [Drive Timeout Waiting for Response]	0413	FAn1 [Drive Cooling Fan Fault]
0239	oFb38 [Control Command Selection Error]	0414	CP1 [Comparator 1 Limit Fault]
023A	oFb39 [Drive timeout waiting for response]	0415	CP2 [Comparator 2 Limit Fault]
		0416	bCE [Bluetooth Communication Fault]

■ Minor Fault/Alarm Contents

Table 5.15 lists the minor fault/alarm codes that communications register (007 (Hex.)) reads.

Table 5.15 Minor Fault/Alarm Contents (007 (Hex.))

Minor Fault/Alarm Code (Hex.)	Name	Minor Fault/Alarm Code (Hex.)	Name
0001	Uv [Undervoltage]	0006	oL4 [Overtorque 2]
0002	ov [DC Bus Overvoltage]	0007	EF [FWD/REV Run Command Input Error]
0003	oH [Heatsink Overheat]	0008	bb [Baseblock]
0004	oH2 [External Overheat (H1-XX=B)]	0009	EF3 [External Fault (Terminal S3)]
0005	oL3 [Overtorque 1]	000A	EF4 [External Fault (Terminal S4)]

Minor Fault/Alarm Code (Hex.)	Name	Minor Fault/Alarm Code (Hex.)	Name
000B	EF5 [External Fault (Terminal S5)]	0031	E5 [MECHATROLINK Watchdog Timer Err]
000C	EF6 [External Fault (Terminal S6)]	0032	AEr [Station Address Setting Error]
000D	EF7 [External Fault (Terminal S7)]	0033	CyC [MECHATROLINK CommCycleSettingErr]
000E	EF8 [External Fault (Terminal S8)]	0034	HCA [High Current Alarm]
000F	FAn [Internal Fan Fault]	0035	LT-1 [Cooling Fan Maintenance Time]
0010	oS [Overspeed]	0036	LT-2 [Capacitor Maintenance Time]
0011	dEv [Speed Deviation]	0039	EF1 [External Fault (Terminal S1)]
0012	PGo [Encoder (PG) Feedback Loss]	003A	EF2 [External Fault (Terminal S2)]
0014	CE [Modbus Communication Error]	003B	SToF [Safe Torque OFF Hardware]
0015	bUS [Option Communication Error]	003C	STo [Safe Torque OFF]
0016	CALL [Serial Comm Transmission Error]	003D	oL5 [Mechanical Weakening Detection 1]
0017	oL1 [Motor Overloaded]	003E	UL5 [Mechanical Weakening Detection 2]
0018	oL2 [Drive Overloaded]	0042	TrPC [IGBT Maintenance Time (90%)]
001A	EF0 [Option Card External Fault]	0043	LT-3 [SoftChargeBypassRelay MainteTime]
001B	rUn [Motor Switch during Run]	0044	LT-4 [IGBT Maintenance Time (50%)]
001D	CALL [Serial Comm Transmission Error]	0045	boL [Braking Transistor Overload]
001E	UL3 [Undertorque Detection 1]	0049	dWAL [DriveWorksEZ Alarm]
001F	UL4 [Undertorque Detection 2]	004A	dWA2 [DriveWorksEZ Alarm 2]
0020	SE [Modbus Test Mode Error]	004B	dWA3 [DriveWorksEZ Alarm 3]
0021	L24v [Loss of External Power 24 Supply]	0081	EP24v [External Power 24V Supply]
0022	oH3 [Motor Overheat (PTC Input)]	0085	bAT [Keypad Battery Low Voltage]
0027	FbL [PID Feedback Loss]	0087	CP1 [Comparator 1 Limit Error]
0028	FbH [Excessive PID Feedback]	0088	CP2 [Comparator 2 Limit Error]
002A	dnE [Drive Disabled]	0089	TiM [Keypad Time Not Set]
002B	PGoH [Encoder (PG) Hardware Fault]	008A	bCE [Bluetooth Communication Error]

## ◆ Error Codes

### ■ MEMOBUS/Modbus Communications Error Code List

Table 5.16 lists the MEMOBUS/Modbus communications error codes.

When an error occurs, remove the cause of the error and restart communications.

**Table 5.16 MEMOBUS/Modbus Communications Error Codes**

Error Code (Hex.)	Name	Cause
01	Function Code Error	The PLC set a function code that was not 03, 08, or 10 (Hex.)
02	Register Number Error	<ul style="list-style-type: none"> <li>The register number that is trying to access is not registered.</li> <li>A starting number that was not 0001 or 0002 (Hex.) was set when broadcasting.</li> </ul>
03	Bit Count Error	<ul style="list-style-type: none"> <li>Read and write data quantities are more than the 1 to 16 range. (Command message data quantity is disabled.)</li> <li>The data that was read from non-consecutive holding registers contained more than 120 bytes.</li> <li>The data to be written to non-consecutive holding registers contained more than 60 bytes.</li> <li>In the write mode, the number of bytes in the message is not the number of data × 2.</li> </ul>
21	Data Setting Error	<ul style="list-style-type: none"> <li>Writing control data or parameters made the settings go out of the permitted setting range.</li> <li>A parameter setting error occurred when writing a parameter.</li> </ul>

## 5.3 MEMOBUS/Modbus Communications

Error Code (Hex.)	Name	Cause
22	Write Mode Error	<ul style="list-style-type: none"> <li>• Tried to write a disabled parameter during run.</li> <li>• When there was a <i>CPF06 [EEPROM Memory Data Error]</i>, the master tried to write a parameter other than one of these:               <ul style="list-style-type: none"> <li>– <i>A1-00 [Language Selection]</i></li> <li>– <i>A1-01 [Access Level Selection]</i></li> <li>– <i>A1-02 [Control Method Selection]</i></li> <li>– <i>A1-03 [Initialize Parameters]</i></li> <li>– <i>A1-04: [Password]</i></li> <li>– <i>A1-05: [Password Setting]</i></li> <li>– <i>E1-03 [V/f Pattern Selection]</i></li> <li>– <i>o2-04 [Drive Model (KVA) Selection]</i></li> </ul> </li> <li>• Writes the read-only data.</li> </ul>
23	DC Bus Undervoltage Write Error	During <i>Uv [DC Bus Undervoltage]</i> , a <i>Uv</i> write disabled parameter was written.
24	Error Writing Data During Parameter Processing	Tried to write a parameter from the master during parameter processing on the drive side.
25	Writing into EEPROM Disabled	Writing into EEPROM write is disabled, but EEPROM write was executed from MEMOBUS/Modbus communications. When this error occurs, the keypad shows a message and the drive continues operation.

### ■ No Response from Slave

The slave ignores the command message from the master and will not send a response message in these conditions:

- When a communications error (overrun, framing, parity, CRC-16) is detected in the command message.
- When the slave address in the command message and the slave address for the drive side do not agree (Use *H5-01 [Drive Node Address]* to set the slave address of the drive)
- When the time interval between the data of which the message is composed is longer than 24 bits
- When the data length for the command message is not accurate

#### Note:

- If the keypad shows *CALL [Serial Comm Transmission Error]*, refer to “Troubleshooting” to remove the cause of the error, and try to do communications again. If the keypad does not show *CALL*, check *U1-19 [MEMOBUS/Modbus Error Code]* for the error and error type.
- If you execute the write function code when the slave address in the command message is 00 (Hex.), all of the slaves will execute the write command, but they will not send response messages to the master.

# Troubleshooting

---

<b>6.1</b>	<b>General Safety .....</b>	<b>328</b>
<b>6.2</b>	<b>Types of Faults, Minor Faults, Alarms, and Errors .....</b>	<b>330</b>
<b>6.3</b>	<b>List of Fault, Minor Fault, Alarm, and Error Codes .....</b>	<b>331</b>
<b>6.4</b>	<b>Faults .....</b>	<b>337</b>
<b>6.5</b>	<b>Minor Faults/Alarms .....</b>	<b>361</b>
<b>6.6</b>	<b>Parameter Setting Errors.....</b>	<b>374</b>
<b>6.7</b>	<b>Auto-Tuning Errors .....</b>	<b>381</b>
<b>6.8</b>	<b>Backup Function Operating Mode Display and Errors.....</b>	<b>386</b>
<b>6.9</b>	<b>Diagnosing and Resetting Faults.....</b>	<b>388</b>
<b>6.10</b>	<b>Troubleshooting Without Fault Display.....</b>	<b>389</b>

## 6.1 General Safety

### DANGER

#### Electrical Shock Hazard

**Do not examine, connect, or disconnect wiring on an energized drive. Before servicing, disconnect all power to the equipment and wait for the time specified on the warning label at a minimum. The internal capacitor stays charged after the drive is de-energized. The charge indicator LED extinguishes when the DC bus voltage decreases below 50 Vdc. When all indicators are OFF, remove the covers before measuring for dangerous voltages to make sure that the drive is safe.**

Failure to obey will cause death or serious injury.

### WARNING

#### Electrical Shock Hazard

**Do not operate equipment when covers are missing. Some figures in this section include drives without covers or safety shields to more clearly show the inside of the drive. Replace covers and shields before operation. Use drives only as specified by the instructions.**

Failure to obey can cause death or serious injury.

**Always ground the motor-side grounding terminal.**

Contacting the motor case can cause death or serious injury from incorrect equipment grounding.

**Do not immediately energize the drive or operate peripheral devices after the drive blows a fuse or trips an RCM/RCD. Wait for the time specified on the warning label at a minimum and make sure that all indicators are OFF. Then check the wiring and peripheral device ratings to find the cause of the problem. Contact Yaskawa before energizing the drive or peripheral devices if the cause is not known.**

Failure to obey can cause death or serious injury and damage to the drive.

**Only let authorized persons install, wire, maintain, examine, replace parts, and repair the drive.**

Failure to obey can cause death or serious injury.

**Do not work on the drive or around the drive while wearing loose clothing or jewelry. Tighten loose clothing and remove all metal objects such as watches or rings.**

Failure to obey can cause death or serious injury.

**Do not remove covers or touch circuit boards while the drive is energized.**

Failure to obey can cause death or serious injury.

**Do not make changes to the drive body or drive circuitry.**

Failure to obey can cause death or serious injury and will void warranty. Yaskawa is not responsible for changes to the product made by the user.

#### Fire Hazard

**Tighten all terminal screws to the correct tightening torque.**

Connections that are too loose or too tight can cause incorrect operation and damage to the drive. Incorrect connections can also cause death or serious injury from fire.

**Tighten screws against the bit at an angle in the specified range shown in this manual.**

If you tighten the screws at an angle not in the specified range, you can have loose connections that can cause damage to the terminal block or start a fire.

**Do not use the main circuit power supply (Overcurrent Category III) at incorrect voltages. Make sure that the drive rated voltage aligns with the power supply voltage before energizing the drive.**

Failure to obey can cause death or serious injury.

**Do not put flammable or combustible materials on top of the drive and do not install the drive near flammable or combustible materials. Attach the drive to metal or other noncombustible material.**

Failure to obey can cause death or serious injury.



**⚠ WARNING****Sudden Movement Hazard**

**Do not do work on the drive without eye protection. Wear eye protection before you start work on the drive.**

Failure to obey could cause serious injury or death.

**Crush Hazard**

**Use a lifting mechanism made to move large drives when necessary.**

Failure to obey can cause death or serious injury from falling equipment.

**NOTICE**

**Observe correct electrostatic discharge (ESD) procedures when touching the drive and circuit boards.**

Failure to obey can cause ESD damage to the drive circuitry.

**Do not connect or disconnect the motor from the drive while the drive is supplying voltage.**

Incorrect equipment sequencing can cause damage to the drive.

**Do not use unshielded wire for control wiring. Use shielded, twisted-pair wires and ground the shield to the ground terminal of the drive.**

Failure to obey can cause electrical interference and unsatisfactory system performance.

**Make sure that all connections are correct after you install the drive and connecting peripheral devices.**

Failure to obey can cause damage to the drive.

## 6.2 Types of Faults, Minor Faults, Alarms, and Errors

If the drive or motor do not operate correctly, check the drive keypad for a code or message.



If problems occur that are not identified in this manual, contact the nearest Yaskawa representative with this information:

- Drive model
- Drive software version
- Date of purchase
- Description of the problem (such as failure conditions)

Table 6.1 contains descriptions of the different types of faults, minor faults, alarms, and errors that can occur during drive operation.

Contact Yaskawa if there is damage to the drive. Contact information is on the back cover of the manual.

**Table 6.1 Types of Faults, Minor Faults, Alarms, and Errors**

Type	Drive Response
Faults	<p>When the drive detects a fault, it will cause these conditions:</p> <ul style="list-style-type: none"> <li>• The keypad shows the fault code and  and ALM/ERR of the LED Status Ring illuminate continuously.</li> <li>• The drive shuts off output, and the motor coasts to a stop. Some faults let the user select a motor stopping method.</li> <li>• Fault relay output MA-MC will turn ON, and MB-MC will turn OFF.</li> </ul> <p>The drive will not operate until you clear the fault with a Fault Reset and the drive goes back to usual status.</p>
Minor Faults/Alarms	<p>When the drive detects a minor fault or an alarm, it will cause these conditions:</p> <ul style="list-style-type: none"> <li>• The keypad shows the alarm code and  and ALM/ERR on the LED Status Ring flash.</li> <li>• The drive will continue to operate the motor. Some alarms let the user select a motor stopping method.</li> <li>• If the drive detects a minor fault, the terminal set to <math>H2-01</math> to <math>H2-03 = 10</math> [MFDO Function Select = Alarm] will switch ON. If you do not set parameters <math>H2-01</math> to <math>H2-03</math>, the drive will not trigger MFDO terminals when it detects a minor fault.</li> <li>• The drive will not output a minor fault signal when it detects an alarm.</li> </ul> <p>It is not necessary to do Fault Reset.</p>
Operation Errors	<p>An error occurs when parameter settings do not agree or a parameter combination is incorrect. The drive will not operate until you set the parameters correctly.</p> <p>When the drive detects an operation error, these conditions will result:</p> <ul style="list-style-type: none"> <li>• The keypad shows the error code.</li> <li>• Multi-function outputs do not output an alarm signal.</li> </ul> <p>Find the parameters that caused the error and correct the settings.</p>
Auto-Tuning Errors	<p>An error occurs during Auto-Tuning.</p> <p>When the drive detects a tuning error, it will cause these conditions:</p> <ul style="list-style-type: none"> <li>• The keypad shows the error code.</li> <li>• Multi-function outputs do not output an alarm signal.</li> <li>• The motor coasts to stop.</li> </ul> <p>Remove the cause of the error and do Auto-Tuning again.</p>
Copy Function Errors	<p>An error occurs when you use the keypad for a backup, restore, or verify operation.</p> <p>When the drive detects a copy function error, it will cause these conditions:</p> <ul style="list-style-type: none"> <li>• The keypad shows the error code.</li> <li>• Multi-function outputs do not output an alarm signal.</li> </ul> <p>Push a key on the keypad to clear the error. Remove the cause of the error and try the backup, restore, or verify operation again.</p>

## 6.3 List of Fault, Minor Fault, Alarm, and Error Codes

Table 6.2 shows the possible fault, minor fault, alarm, and error codes.

The display codes are in alphabetical order. Search the table for the code shown on the keypad, and identify its causes and possible solutions.

**Note:**

The number in parentheses adjacent to the code in the table identifies the fault code or minor fault code (hex. number) that was read during MEMOBUS/Modbus communications.

Example: AEr (0032)

**Table 6.2 List of Fault, Minor Fault, Alarm, and Error Codes**

Display (Hex.)	Name	ALM LED	Type	Ref.
AEr (0032)	Station Address Setting Error	Flashing	Alarm	361
bAT (0085)	Keypad Battery Low Voltage	Flashing	Alarm	361
bAT (0402)	Keypad Battery Low Voltage	Illuminated	Fault	337
bb (0008)	Baseblock	Flashing	Alarm	361
bCE (008A)	Bluetooth Communication Error	Flashing	Alarm	361
bCE (0416)	Bluetooth Communication Fault	Illuminated	Fault	337
boL (0045)	Braking Transistor Overload	Flashing	Alarm	361
boL (004F)	Braking Transistor Overload Fault	Illuminated	Fault	337
bUS (0015)	Option Communication Error	Flashing	Alarm	361
bUS (0022)	Option Communication Error	Illuminated	Fault	337
CALL (001D)	Serial Comm Transmission Error	Flashing	Alarm	362
CE (0014)	Modbus Communication Error	Flashing	Alarm	362
CE (0021)	Modbus Communication Error	Illuminated	Fault	338
CF (0025)	Control Fault	Illuminated	Fault	338
CoF (0046)	Current Offset Fault	Illuminated	Fault	339
CP1 (0087)	Comparator 1 Limit Error	Flashing	Alarm	363
CP1 (0414)	Comparator 1 Limit Fault	Illuminated	Fault	339
CP2 (0088)	Comparator 2 Limit Error	Flashing	Alarm	363
CP2 (0415)	Comparator 2 Limit Fault	Illuminated	Fault	339
CPEr	Control Mode Mismatch	-	Copy Function Error	386
CPF00, CPF01 CPF02, CPF03 (0083, 0084) CPF07, CPF08 (0088, 0089) CPF11 to CPF14 (008C to 008F) CPF16 to CPF24 (0091 to 0099) CPF26 to CPF38 (009B to 00A7) CPF40 to CPF45 (00A9 to 00AE)	Control Circuit Error	Illuminated	Fault	339
CPF06 (0087)	EEPROM Memory Data Error	Illuminated	Fault	339
CPF25 (009A)	Terminal Board not Connected	Illuminated	Fault	340
CPyE	Error Writing Data	-	Copy Function Error	386
CrST	Cannot Reset	Flashing	Not an alarm.	363
CSEr	Control Mode Mismatch	-	Copy Function Error	386
CyC (0033)	MECHATROLINK CommCycleSettingErr	Flashing	Alarm	363

## 6.3 List of Fault, Minor Fault, Alarm, and Error Codes

Display (Hex.)	Name	ALM LED	Type	Ref.
dEv (0011)	Speed Deviation	Flashing	Alarm	363
dEv (0019)	Speed Deviation	Illuminated	Fault	340
dFPS	Drive Model Mismatch	-	Copy Function Error	386
dnE (002A)	Drive Disabled	Flashing	Alarm	364
dv1 (0032)	Z Pulse Fault	Illuminated	Fault	340
dv2 (0033)	Z Pulse Noise Fault Detection	Illuminated	Fault	340
dv3 (0034)	Inversion Detection	Illuminated	Fault	340
dv4 (0035)	Inversion Prevention Detection	Illuminated	Fault	341
dv7 (005B)	Polarity Judge Timeout	Illuminated	Fault	341
dWA2 (004A)	DriveWorksEZ Alarm 2	Flashing	Alarm	364
dWA3 (004B)	DriveWorksEZ Alarm 3	Flashing	Alarm	364
dWAL (0049)	DriveWorksEZ Alarm	Flashing	Alarm	364
dWF1 (004A)	EEPROM Memory DWEZ Data Error	Illuminated	Fault	341
dWF2 (004B)	DriveWorksEZ Fault 2	Illuminated	Fault	342
dWF3 (004C)	DriveWorksEZ Fault 3	Illuminated	Fault	342
dWFL (0049)	DriveWorksEZ Fault	Illuminated	Fault	342
E5 (0031)	MECHATROLINK Watchdog Timer Err	Flashing	Alarm	364
E5 (0039)	MECHATROLINK Watchdog Timer Err	Illuminated	Fault	342
EF (0007)	FWD/REV Run Command Input Error	Flashing	Alarm	364
EF0 (001A)	Option Card External Fault	Flashing	Alarm	364
EF0 (0027)	Option Card External Fault	Illuminated	Fault	342
EF1 (0042)	External Fault (Terminal S1)	Illuminated	Fault	342
EF1 (0039)	External Fault (Terminal S1)	Flashing	Alarm	364
EF2 (003A)	External Fault (Terminal S2)	Flashing	Alarm	365
EF2 (0043)	External Fault (Terminal S2)	Illuminated	Fault	342
EF3 (0009)	External Fault (Terminal S3)	Flashing	Alarm	365
EF3 (0011)	External Fault (Terminal S3)	Illuminated	Fault	343
EF4 (000A)	External Fault (Terminal S4)	Flashing	Alarm	365
EF4 (0012)	External Fault (Terminal S4)	Illuminated	Fault	343
EF5 (000B)	External Fault (Terminal S5)	Flashing	Alarm	365
EF5 (0013)	External Fault (Terminal S5)	Illuminated	Fault	343
EF6 (000C)	External Fault (Terminal S6)	Flashing	Alarm	365
EF6 (0014)	External Fault (Terminal S6)	Illuminated	Fault	343
EF7 (000D)	External Fault (Terminal S7)	Flashing	Alarm	366
EF7 (0015)	External Fault (Terminal S7)	Illuminated	Fault	343
EF8 (000E)	External Fault (Terminal S8)	Flashing	Alarm	366
EF8 (0016)	External Fault (Terminal S8)	Illuminated	Fault	344
End1	Excessive Rated Voltage Setting	Flashing	Auto-Tuning Errors	381
End2	Iron Core Saturation Coefficient	Flashing	Auto-Tuning Errors	381
End3	Rated Current Setting Alarm	Flashing	Auto-Tuning Errors	381
End4	Adjusted Slip Calculation Error	Flashing	Auto-Tuning Errors	381
End5	Resistance Tuning Error	Flashing	Auto-Tuning Errors	381
End6	Leakage Inductance Alarm	Flashing	Auto-Tuning Errors	381

Display (Hex.)	Name	ALM LED	Type	Ref.
End7	No-Load Current Alarm	Flashing	Auto-Tuning Errors	382
EP24v (0081)	External Power 24V Supply	Flashing	Alarm	366
Er-01	Motor Data Error	Flashing	Auto-Tuning Errors	382
Er-02	Drive in an Alarm State	Flashing	Auto-Tuning Errors	382
Er-03	STOP Button was Pressed	Flashing	Auto-Tuning Errors	382
Er-04	Line-to-Line Resistance Error	Flashing	Auto-Tuning Errors	382
Er-05	No-Load Current Error	Flashing	Auto-Tuning Errors	383
Er-08	Rated Slip Error	Flashing	Auto-Tuning Errors	383
Er-09	Acceleration Error	Flashing	Auto-Tuning Errors	383
Er-10	Motor Direction Error	Flashing	Auto-Tuning Errors	383
Er-11	Motor Speed Error	Flashing	Auto-Tuning Errors	384
Er-12	Current Detection Error	Flashing	Auto-Tuning Errors	384
Er-13	Leakage Inductance Error	Flashing	Auto-Tuning Errors	384
Er-14	Motor Speed Error 2	Flashing	Auto-Tuning Errors	384
Er-15	Torque Saturation Error	Flashing	Auto-Tuning Errors	384
Er-16	Inertia ID Error	Flashing	Auto-Tuning Errors	384
Er-17	Reverse Prohibited Error	Flashing	Auto-Tuning Errors	384
Er-18	Back EMF Error	Flashing	Auto-Tuning Errors	384
Er-19	PM Inductance Error	Flashing	Auto-Tuning Errors	385
Er-20	Stator Resistance Error	Flashing	Auto-Tuning Errors	385
Er-21	Z Pulse Correction Error	Flashing	Auto-Tuning Errors	385
Er-25	HighFreq Inject Param Tuning Err	Flashing	Auto-Tuning Errors	385
Err (001F)	EEPROM Write Error	Illuminated	Fault	344
FAn (000F)	Internal Fan Fault	Flashing	Alarm	366
FAn (0017)	Internal Fan Fault	Illuminated	Fault	344
FAn1 (0413)	Drive Cooling Fan Fault	Illuminated	Fault	344
FbH (0028)	Excessive PID Feedback	Flashing	Alarm	366
FbH (0041)	Excessive PID Feedback	Illuminated	Fault	344
FbL (0027)	PID Feedback Loss	Flashing	Alarm	367
FbL (0028)	PID Feedback Loss	Illuminated	Fault	345
GF (0006)	Ground Fault	Illuminated	Fault	345
HCA (0034)	High Current Alarm	Flashing	Alarm	367
iFEr	Keypad Communication Error	-	Copy Function Error	386
L24v (0021)	Loss of External Power 24 Supply	Flashing	Alarm	367
LF (001C)	Output Phase Loss	Illuminated	Fault	345
LF2 (0036)	Output Current Imbalance	Illuminated	Fault	346
LoG	Com Error / Abnormal SD card	Flashing	Alarm	368
LSO (0051)	Low Speed Motor Step-Out	Illuminated	Fault	346
LT-1 (0035)	Cooling Fan Maintenance Time	Flashing	Alarm	368
LT-2 (0036)	Capacitor Maintenance Time	Flashing	Alarm	368
LT-3 (0043)	SoftChargeBypassRelay MainteTime	Flashing	Alarm	368
LT-4 (0044)	IGBT Maintenance Time (50%)	Flashing	Alarm	368
ndAT	Error Received Data	-	Copy Function Error	386

## 6.3 List of Fault, Minor Fault, Alarm, and Error Codes

Display (Hex.)	Name	ALM LED	Type	Ref.
nSE (0052)	Node Setup Error	Illuminated	Fault	346
oC (0007)	Overcurrent	Illuminated	Fault	347
oFA00 (0101)	Option Not Compatible with Port	Illuminated	Fault	348
oFA01 (0102)	Option Fault/Connection Error	Illuminated	Fault	348
oFA02 (0103)	Duplicate Options	Illuminated	Fault	348
oFA03 to oFA06 (0104 to 0107)	Option Card Error Occurred at Option Port CN5-A	Illuminated	Fault	348
oFA10, oFA11 (0111, 0112)	Option Card Error Occurred at Option Port CN5-A	Illuminated	Fault	348
oFA12 to oFA17 (0113 to 0118)	Option Card Connection Error (CN5-A)	Illuminated	Fault	349
oFA30 to oFA43 (0131 to 013E)	Communication Option Card Connection Error (CN5-A)	Illuminated	Fault	349
oFb00 (0201)	Option Not Compatible with Port	Illuminated	Fault	349
oFb01 (0202)	Option Fault/Connection Error	Illuminated	Fault	349
oFb02 (0203)	Duplicate Options	Illuminated	Fault	349
oFb03 to oFb11 (0204 to 0212)	Option Card Error Occurred at Option Port CN5-B	Illuminated	Fault	349
oFb12 to oFb17 (0213 to 0218)	Option Card Connection Error (CN5-B)	Illuminated	Fault	349
oFC00 (0301)	Option Not Compatible with Port	Illuminated	Fault	350
oFC01 (0302)	Option Fault/Connection Error	Illuminated	Fault	350
oFC02 (0303)	Duplicate Options	Illuminated	Fault	350
oFC03 to oFC11 (0304 to 0312)	Option Card Error Occurred at Option Port CN5-C	Illuminated	Fault	350
oFC12 to oFC17 (0313 to 0318)	Option Card Connection Error (CN5-C)	Illuminated	Fault	350
oFC50 to oFC55 (0351 to 0356)	Option Card Error Occurred at Option Port CN5-C	Illuminated	Fault	350
oH (0003)	Heatsink Overheat	Flashing	Alarm	368
oH (0009)	Heatsink Overheat	Illuminated	Fault	350
oH1 (000A)	Heatsink Overheat	Illuminated	Fault	351
oH2 (0004)	External Overheat (H1-XX=B)	Flashing	Alarm	369
oH3 (001D)	Motor Overheat (PTC Input)	Illuminated	Fault	351
oH3 (0022)	Motor Overheat (PTC Input)	Flashing	Alarm	369
oH4 (0020)	Motor Overheat Fault (PTC Input)	Illuminated	Fault	352
oL1 (000B)	Motor Overload	Illuminated	Fault	352
oL2 (000C)	Drive Overload	Illuminated	Fault	353
oL3 (0005)	Overtorque 1	Flashing	Alarm	369
oL3 (000D)	Overtorque Detection 1	Illuminated	Fault	354
oL4 (0006)	Overtorque 2	Flashing	Alarm	370
oL4 (000E)	Overtorque Detection 2	Illuminated	Fault	354
oL5 (003D)	Mechanical Weakening Detection 1	Flashing	Alarm	370
oL5 (0044)	Mechanical Weakening Detection 1	Illuminated	Fault	354
oL7 (002B)	High Slip Braking Overload	Illuminated	Fault	354
oPE01	Drive Capacity Setting Error	Flashing	Parameter Setting Errors	374
oPE02	Parameter Range Setting Error	Flashing	Parameter Setting Errors	374

Display (Hex.)	Name	ALM LED	Type	Ref.
oPE03	Multi-Function Input Setting Err	Flashing	Parameter Setting Errors	374
oPE05	Run Cmd/Freq Ref Source Sel Err	Flashing	Parameter Setting Errors	376
oPE06	Control Method Selection Error	Flashing	Parameter Setting Errors	377
oPE07	Analog Input Selection Error	Flashing	Parameter Setting Errors	377
oPE08	Parameter Selection Error	Flashing	Parameter Setting Errors	377
oPE09	PID Control Selection Fault	Flashing	Parameter Setting Errors	378
oPE10	V/f Data Setting Error	Flashing	Parameter Setting Errors	378
oPE11	Carrier Frequency Setting Error	Flashing	Parameter Setting Errors	379
oPE13	Pulse Monitor Selection Error	Flashing	Parameter Setting Errors	379
oPE15	Torque Control Setting Error	Flashing	Parameter Setting Errors	379
oPE16	Energy Saving Constants Error	Flashing	Parameter Setting Errors	379
oPE18	Online Tuning Param Setting Err	Flashing	Parameter Setting Errors	379
oPE20	PG-F3 Setting Error	Flashing	Parameter Setting Errors	380
oPE33	Digital Output Selection Error	Flashing	Parameter Setting Errors	380
oPr (001E)	Keypad Connection Fault	Illuminated	Fault	354
oS (0010)	Overspeed	Flashing	Alarm	370
oS (0018)	Overspeed	Illuminated	Fault	354
ov (0002)	DC Bus Overvoltage	Flashing	Alarm	370
ov (0008)	Overvoltage	Illuminated	Fault	355
PASS	Modbus Communication Test	Flashing	Not an alarm.	371
PF (0047)	Input Phase Loss	Flashing	Alarm	371
PF (001B)	Input Phase Loss	Illuminated	Fault	356
PGo (0012)	Encoder (PG) Feedback Loss	Flashing	Alarm	371
PGo (001A)	Encoder (PG) Feedback Loss	Illuminated	Fault	356
PGoH (002B)	Encoder (PG) Hardware Fault	Flashing	Alarm	371
PGoH (0038)	Encoder (PG) Hardware Fault	Illuminated	Fault	356
rdEr	Error Reading Data	-	Copy Function Error	387
rF (004E)	Braking Resistor Fault	Illuminated	Fault	357
rH (0010)	Braking Resistor Overheat	Illuminated	Fault	357
rr (000F)	Dynamic Braking Transistor Fault	Illuminated	Fault	357
rUn (001B)	Motor Switch during Run	Flashing	Alarm	371
SC (0005)	Short Circuit/IGBT Failure	Illuminated	Fault	357
SCF (040F)	Safety Circuit Fault	Illuminated	Fault	358
SE (0020)	Modbus Test Mode Error	Flashing	Alarm	371
SEr (003B)	Speed Search Retries Exceeded	Illuminated	Fault	358
STo (003C)	Safe Torque OFF	Flashing	Alarm	372
SToF (003B)	Safe Torque OFF Hardware	Flashing	Alarm	372
STPo (0037)	Motor Step-Out Detected	Illuminated	Fault	358
SvE (0026)	Zero Servo Fault	Illuminated	Fault	358
TiM (0089)	Keypad Time Not Set	Flashing	Alarm	372
TiM (0401)	Keypad Time Not Set	Illuminated	Fault	359
TrPC (0042)	IGBT Maintenance Time (90%)	Flashing	Alarm	372
UL3 (001E)	Undertorque Detection 1	Flashing	Alarm	372

### 6.3 List of Fault, Minor Fault, Alarm, and Error Codes

Display (Hex.)	Name	ALM LED	Type	Ref.
UL3 (0029)	Undertorque Detection 1	Illuminated	Fault	<a href="#">359</a>
UL4 (001F)	Undertorque Detection 2	Flashing	Alarm	<a href="#">372</a>
UL4 (002A)	Undertorque Detection 2	Illuminated	Fault	<a href="#">359</a>
UL5 (003E)	Mechanical Weakening Detection 2	Flashing	Alarm	<a href="#">373</a>
UL5 (0045)	Mechanical Weakening Detection 2	Illuminated	Fault	<a href="#">359</a>
Uv (0001)	Undervoltage	Flashing	Alarm	<a href="#">373</a>
Uv1 (0002)	DC Bus Undervoltage	Illuminated	Fault	<a href="#">359</a>
Uv2 (0003)	Control Power Undervoltage	Illuminated	Fault	<a href="#">360</a>
Uv3 (0004)	Soft Charge Answerback Fault	Illuminated	Fault	<a href="#">360</a>
vAEr	Voltage Class, Capacity Mismatch	-	Copy Function Error	<a href="#">387</a>
vFyE	Parameters do not Match	-	Copy Function Error	<a href="#">387</a>



## 6.4 Faults

This section gives information about the causes and possible solutions of faults. You must use the Fault Reset operation to remove the fault before you can operate the drive. Use the information in this table to remove the cause of the fault.

Code	Name	Causes	Possible Solutions
bAT	Keypad Battery Low Voltage	The keypad battery voltage is low.	Replace the keypad battery.
<b>Note:</b> Use o4-24 [bAT Detection Selection] to enable/disable bAT detection.			
Code	Name	Causes	Possible Solutions
bCE	Bluetooth Communication Fault	The smart device with DriveWizard Mobile installed is too far from the keypad.	Use the smart device 10 m (32.8 ft.) or nearer to the keypad. <b>Note:</b> bCE can occur when the smart device is 10 m or nearer to the keypad depending on the specifications of the smart device.
		Radio waves from a different device are causing interference with communications between the smart device and keypad.	Make sure that no device around the keypad uses the same radio bandwidth (2400 MHz to 2480 MHz), and prevent radio interference.
<b>Note:</b> <ul style="list-style-type: none"> <li>The drive detects this error when operating the drive with a smart device using the Bluetooth LCD keypad.</li> <li>Do a Fault Reset to clear the fault.</li> <li>Set the stopping method for this fault in o2-27 [bCE Detection Selection].</li> </ul>			
Code	Name	Causes	Possible Solutions
boL	Braking Transistor Overload Fault	The duty cycle of the braking transistor is high (the regeneration power or repetition frequency is high).	<ul style="list-style-type: none"> <li>Install a braking unit (CDBR-series).</li> <li>Install a regenerative converter.</li> <li>Increase the deceleration time.</li> </ul>
		You enabled the protective function for the braking transistor when you have a regenerative converter.	Set L8-55 = 0 [Internal DB Transistor Protection = Disable].
		The braking transistor in the drive is broken.	Replace the entire drive.
<b>Note:</b> Do a Fault Reset to clear the fault.			
Code	Name	Causes	Possible Solutions
bUS	Option Communication Error	The drive did not receive a signal from the controller.	Correct wiring errors.
		The communications cable wiring is incorrect.	
		There is a short circuit or the communications cable is not connected.	<ul style="list-style-type: none"> <li>Repair short circuits and connect cables.</li> <li>Replace the defective communications cable.</li> </ul>
		Electrical interference caused a communication data error.	<ul style="list-style-type: none"> <li>Examine the control circuit lines, main circuit lines, and ground wiring, and decrease the effects of electrical interference.</li> <li>Make sure that a magnetic contactor is not the source of the electrical interference, then use a Surge Protective Device if necessary.</li> <li>Use only the recommended cables or other shielded line. Ground the shield on the controller side or the drive input power side.</li> <li>Isolate the communication wiring from drive power lines, and install a noise filter to the input side of the power supply for communication.</li> <li>Decrease the effects of electrical interference from the controller.</li> </ul>
	The option card is incorrectly installed to the drive.	Correctly install the option card to the drive.	

## 6.4 Faults

Code	Name	Causes	Possible Solutions
		The option card is damaged.	If the fault continues and the wiring is correct, replace the option card.
<b>Note:</b> <ul style="list-style-type: none"> <li>The drive detects this error if the Run command or frequency reference is assigned to the option card.</li> <li>Do a Fault Reset to clear the fault.</li> <li>If the drive detects this error, the drive will operate the motor as specified by the stopping method set in <i>F6-01 [Communication Error Selection]</i>.</li> </ul>			
Code	Name	Causes	Possible Solutions
CE	Modbus Communication Error	The communications cable wiring is incorrect.	Correct wiring errors.
		There is a short circuit or the communications cable is not connected.	<ul style="list-style-type: none"> <li>Repair short circuits and connect cables.</li> <li>Replace the defective communications cable.</li> </ul>
		Electrical interference caused a communication data error.	<ul style="list-style-type: none"> <li>Examine the control circuit lines, main circuit lines, and ground wiring, and decrease the effects of electrical interference.</li> <li>Make sure that a magnetic contactor is not the source of the electrical interference, then use a Surge Protective Device if necessary.</li> <li>Use only the recommended cables or other shielded line. Ground the shield on the controller side or the drive input power side.</li> <li>Isolate the communication wiring from drive power lines, and install a noise filter to the input side of the power supply for communication.</li> <li>Decrease the effects of electrical interference from the controller.</li> </ul>
<b>Note:</b> <ul style="list-style-type: none"> <li>The drive detects this error if it does not correctly receive control data for the <i>CE</i> detection time set to <i>H5-09 [CE Detection Time]</i>.</li> <li>Do a Fault Reset to clear the fault.</li> <li>If the drive detects this error, the drive will operate the motor as specified by the stopping method set in <i>H5-04 [Communication Error Stop Method]</i>.</li> </ul>			
Code	Name	Causes	Possible Solutions
CF	Control Fault	Motor parameters are set incorrectly	Correctly set the motor parameters and do Auto-Tuning again.
		The torque limit is too low.	Adjust <i>L7-01 to L7-04 [Torque Limit]</i> .
		The load inertia is too big.	<ul style="list-style-type: none"> <li>Adjust <i>C1-02, C1-04, C1-06, and C1-08 [Deceleration Time]</i>.</li> <li>Set the frequency reference to the minimum output frequency, and stop the Run command when the drive stops deceleration.</li> </ul>
		The drive is trying to ramp to stop a machine that cannot do ramp to stop or on a machine for which deceleration is not necessary.	Correctly set <i>b1-03 [Stopping Method Selection]</i> .
		The motor and drive are connected incorrectly.	Correct wiring errors.
		Line-to-line Resistance Tuning is not done.	Do Stationary Auto-Tuning for Line-to-Line Resistance.
		The drive received a Run command while the motor was coasting.	<ul style="list-style-type: none"> <li>Examine the sequence and input the Run command after the motor fully stops.</li> <li>Set <i>b3-01 = 1 [Speed Search at Start Selection = Enabled]</i>.</li> </ul>
<b>Note:</b> <ul style="list-style-type: none"> <li>The drive detects this error if the torque reference is more than the torque limit for 3 seconds or longer while the drive ramps to stop.</li> <li>Do a Fault Reset to clear the fault.</li> </ul>			

Code	Name	Causes	Possible Solutions
CoF	Current Offset Fault	The drive starts operation while the induced voltage stays in the motor (during coasting to a stop or after fast deceleration).	<ul style="list-style-type: none"> <li>Make a sequence that does not restart operation when induced voltage stays in the motor.</li> <li>Set <math>b3-01 = 1</math> [<i>Speed Search at Start Selection = Enabled</i>].</li> <li>Use <i>Speed Search from Fmax or Fref</i> [<math>H1-xx = 61, 62</math>] to do a speed search through one of the external terminals.</li> </ul> <p><b>Note:</b> When controlling the PM motor, External Speed Search commands 1 and 2 operate the same.</p>
		A drive hardware problem occurred.	Replace the drive.
<p><b>Note:</b></p> <ul style="list-style-type: none"> <li>The drive detects this error if the current offset value is more than the permitted setting range while the drive automatically adjusts the current offset.</li> <li>Do a Fault Reset to clear the fault.</li> </ul>			
Code	Name	Causes	Possible Solutions
CP1	Comparator 1 Limit Fault	The monitor value set in $H2-20$ [ <i>Comparator 1 Monitor Selection</i> ] was within the range of $H2-21$ [ <i>Comparator 1 Lower Limit</i> ] and $H2-22$ [ <i>Comparator 1 Upper Limit</i> ].	Examine the monitor value and remove the cause of the fault.
<p><b>Note:</b></p> <ul style="list-style-type: none"> <li>The drive detects this error when the terminal is assigned to <math>H2-01</math> to <math>H2-03 = 66</math> [<i>MFDO Function Select = Comparator1</i>].</li> <li>Do a Fault Reset to clear the fault.</li> <li>Set the stopping method for this fault in <math>H2-33</math> [<i>Comparator1 Protection Selection</i>].</li> </ul>			
Code	Name	Causes	Possible Solutions
CP2	Comparator 2 Limit Fault	The monitor value set in $H2-26$ [ <i>Comparator 2 Monitor Selection</i> ] was outside the range of $H2-27$ [ <i>Comparator 2 Lower Limit</i> ] and $H2-28$ [ <i>Comparator 2 Upper Limit</i> ].	Examine the monitor value and remove the cause of the fault.
<p><b>Note:</b></p> <ul style="list-style-type: none"> <li>The drive detects this error when the terminal is assigned to <math>H2-01</math> to <math>H2-03 = 67</math> [<i>MFDO Function Select = Comparator2</i>].</li> <li>Do a Fault Reset to clear the fault.</li> <li>Set the stopping method for this fault in <math>H2-35</math> [<i>Comparator2 Protection Selection</i>].</li> </ul>			
Code	Name	Causes	Possible Solutions
CPF00 to CPF03, CPF07 to CPF08, CPF11 to CPF14, CPF16 to CPF24, CPF26 to CPF38, and CPF40 to CPF45	Control Circuit Error	A drive hardware problem occurred.	<ul style="list-style-type: none"> <li>Re-energize the drive.</li> <li>If the fault stays, replace the control board or the drive. For information about replacing the control board, contact Yaskawa or your nearest sales representative.</li> </ul>
<p><b>Note:</b></p> <ul style="list-style-type: none"> <li>Do a Fault Reset to clear the fault.</li> <li>Fault trace is not available for these faults.</li> </ul>			
Code	Name	Causes	Possible Solutions
CPF06	EEPROM Memory Data Error	The drive power supply was de-energized while a communication option card entered a parameter Write command.	Set $A1-03 = 2220, 3330$ [ <i>Initialize Parameters = 2-Wire Initialization, 3-Wire Initialization</i> ] and initialize the drive.
		An EEPROM peripheral circuit error occurred.	<ul style="list-style-type: none"> <li>Re-energize the drive.</li> <li>If the fault stays, replace the control board or the drive. For information about replacing the control board, contact Yaskawa or your nearest sales representative.</li> </ul>
<p><b>Note:</b></p> <ul style="list-style-type: none"> <li>The drive detects this error if there is an error in the data written to the EEPROM of the drive.</li> <li>Do a Fault Reset to clear the fault.</li> <li>Fault trace is not available for this fault.</li> </ul>			

## 6.4 Faults

Code	Name	Causes	Possible Solutions
CPF25	Terminal Board not Connected	The terminal board is not correctly connected to the drive.	<ol style="list-style-type: none"> <li>1. De-energize the drive.</li> <li>2. Correctly connect the terminal board to the drive.</li> <li>3. Re-energize the drive.</li> </ol>
<b>Note:</b> Do a Fault Reset to clear the fault.			
Code	Name	Causes	Possible Solutions
dEv	Speed Deviation	The load is too heavy.	Decrease the load.
		Acceleration and deceleration times are set too short.	Increase the values set in <i>C1-01 to C1-08 [Acceleration/Deceleration Time]</i> .
		The <i>dEv</i> detection level settings are incorrect.	Adjust <i>F1-10 [Speed Deviation Detection Level]</i> and <i>F1-11 [Speed Deviation Detect DelayTime]</i> .
		The load is locked up.	Examine the machine.
		The holding brake is stopping the motor.	Release the holding brake.
<b>Note:</b> <ul style="list-style-type: none"> <li>• The drive detects this error if the difference between the detected speed and the speed reference is more than the setting of <i>F1-10</i> for longer than <i>F1-11</i>.</li> <li>• Do a Fault Reset to clear the fault.</li> <li>• If the drive detects this error, the drive will operate the motor as specified by the stopping method set in <i>F1-04 [Speed Deviation Detection Select]</i>.</li> </ul>			
Code	Name	Causes	Possible Solutions
dv1	Z Pulse Fault	The encoder option card or the encoder on the motor side is damaged.	<ol style="list-style-type: none"> <li>1. Repair wiring errors and connect disconnected wires. Correctly ground the shielded wire of the encoder cable.</li> <li>2. Re-energize the drive</li> <li>3. If the fault stays, replace the control board or the drive. For information about replacing the control board, contact Yaskawa or your nearest sales representative.</li> </ol>
		The encoder cable is disconnected or wired incorrectly.	
<b>Note:</b> <ul style="list-style-type: none"> <li>• The drive detects this error if it does not detect a Z pulse during one motor rotation.</li> <li>• Do a Fault Reset to clear the fault.</li> </ul>			
Code	Name	Causes	Possible Solutions
dv2	Z Pulse Noise Fault Detection	Noise interference along the encoder cable.	Isolate the encoder cable from the drive output line or a different source of electrical interference.
		The encoder cable is disconnected or wired incorrectly.	Repair wiring errors and connect disconnected wires. Correctly ground the shielded wire of the encoder cable.
		The PG option card or the encoder on the motor side is damaged.	Repair the wiring and re-energize the drive, then replace the PG option card or the encoder if the problem continues.
<b>Note:</b> <ul style="list-style-type: none"> <li>• The drive detects this error if it does not detect a Z pulse during one motor rotation.</li> <li>• Do a Fault Reset to clear the fault.</li> </ul>			
Code	Name	Causes	Possible Solutions
dv3	Inversion Detection	<i>E5-11 [Encoder Z-Pulse Offset]</i> is set incorrectly.	Correctly set the value for $\Delta\theta$ to <i>E5-11</i> as specified by the values on the motor nameplate.
		There is a new encoder or the motor rotation direction changed.	Do Z Pulse Offset Tuning.
		An external force on the load side rotated the motor.	<ul style="list-style-type: none"> <li>• Make sure that the motor is rotating in the correct direction.</li> <li>• Find and repair problems on the load side that cause the motor to rotate from the load side.</li> </ul>
		Noise interference along the encoder cable.	Correctly ground the shielded wire of the encoder cable.
		The encoder cable is disconnected or incorrectly wired.	Examine for wiring errors or disconnected wires in the encoder cable, and repair problems.

Code	Name	Causes	Possible Solutions
		The setting for <i>F1-05 [No Alarm Display]</i> is the opposite of the direction of motor rotation.	Correctly connect the motor wiring for each phase (U, V, W).
		The PG option card or the encoder on the motor side is damaged.	Repair the wiring and re-energize the drive, then replace the PG option card or the encoder if the problem continues.

**Note:**

- The drive detects this error if:
  - the torque reference and acceleration are in opposite directions.
  - the speed reference and actual motor speed are more than 30% different for the number of times set to *F1-18 [Deviation 3 Detection Selection]*.
- Do a Fault Reset to clear the fault.

Code	Name	Causes	Possible Solutions
dv4	Inversion Prevention Detection	An external force on the load side moved the motor.	<ul style="list-style-type: none"> <li>• Make sure that the motor is rotating in the correct direction.</li> <li>• Find and repair problems on the load side that cause the motor to rotate from the load side.</li> <li>• Disable detection of this fault for applications that rotate the motor from the load side in the opposite direction of the speed reference. The drive will not detect this fault if <i>F1-19 = 0 [Deviation 4 Detection Selection = Disabled]</i>.</li> </ul>
		<i>E5-11 [Encoder Z-Pulse Offset]</i> is set incorrectly.	Correctly set the value for $\Delta\theta$ to <i>E5-11</i> as specified by the values on the motor nameplate.
		There is a new encoder or the motor rotation direction changed.	Do Z Pulse Offset Tuning.
		Noise interference along the encoder cable	Correctly ground the shielded wire of the encoder cable.
		The encoder cable is disconnected or incorrectly wired.	Examine for wiring errors or disconnected wires in the encoder cable, and repair problems.
		The PG option card or the encoder on the motor side is damaged.	Repair the wiring and re-energize the drive, then replace the PG option card or the encoder if the problem continues.

**Note:**

- The drive detects this error if the pulses in the opposite direction of the speed reference are more than the value set in *F1-19*.
- Do a Fault Reset to clear the fault.

Code	Name	Causes	Possible Solutions
dv7	Polarity Judge Timeout	There is a disconnection in the motor coil winding.	Measure the motor line-to-line resistance and replace the motor if a coil is disconnected.
		The screws on the drive output terminals are loose.	Tighten the terminal screws to the correct tightening torque.

**Note:**

- The drive detects this error if it cannot detect polarity in a pre-set length of time.
- Do a Fault Reset to clear the fault.

Code	Name	Causes	Possible Solutions
dWF1	EEPROM Memory DWEZ Data Error	There is an error in the EEPROM peripheral circuit.	<ul style="list-style-type: none"> <li>• Re-energize the drive.</li> <li>• If the fault stays, replace the control board or the drive. For information about replacing the control board, contact Yaskawa or your nearest sales representative.</li> </ul>
		There is a problem with the EEPROM data.	Set <i>A1-03 = 2220, 3330 [Initialize Parameters = 2-Wire Initialization, 3-Wire Initialization]</i> to initialize the drive, then upload the DriveWorksEZ project to the drive again.

**Note:**


- The drive detects this error if there is an error in the DriveWorksEZ program that was saved to EEPROM.
- Do a Fault Reset to clear the fault.

## 6.4 Faults

Code	Name	Causes	Possible Solutions
dWF2	DriveWorksEZ Fault 2	There was a fault in the DriveWorksEZ program.	Examine the DriveWorksEZ program and remove the cause of the fault. This is not a drive fault.
<b>Note:</b> Do a Fault Reset to clear the fault.			
Code	Name	Causes	Possible Solutions
dWF3	DriveWorksEZ Fault 3	There was a fault in the DriveWorksEZ program.	Examine the DriveWorksEZ program and remove the cause of the fault. This is not a drive fault.
<b>Note:</b> Do a Fault Reset to clear the fault.			
Code	Name	Causes	Possible Solutions
dWFL	DriveWorksEZ Fault	There was a fault in the DriveWorksEZ program.	Examine the DriveWorksEZ program and remove the cause of the fault. This is not a drive fault.
<b>Note:</b> Do a Fault Reset to clear the fault.			
Code	Name	Causes	Possible Solutions
E5	MECHATROLINK Watchdog Timer Err	The drive detected a watchdog circuit exception while it received data from the controller.	Examine the MECHATROLINK cable connection. If this error occurs frequently, examine the wiring and decrease the effects of electrical interference as specified by these manuals: <ul style="list-style-type: none"> <li>MECHATROLINK-II Installation Guide (MECHATROLINK Members Association, manual number MMATDEP011)</li> <li>MECHATROLINK-III Installation Guide (MECHATROLINK Members Association, manual number MMATDEP018)</li> </ul>
<b>Note:</b> <ul style="list-style-type: none"> <li>Do a Fault Reset to clear the fault.</li> <li>If the drive detects this fault, it will operate the motor as specified by the stop method set in F6-25 [MECHATROLINK Watchdog Error Sel].</li> </ul>			
Code	Name	Causes	Possible Solutions
EF0	Option Card External Fault	The communication option card received an external fault from the controller.	1. Find the device that caused the external fault and remove the cause. 2. Clear the external fault input from the controller.
		A programming error occurred on the controller side.	Examine the operation of the controller program.
<b>Note:</b> <ul style="list-style-type: none"> <li>The drive detects this fault if the alarm function on the external device side is operating.</li> <li>Do a Fault Reset to clear the fault.</li> <li>If the drive detects this fault, it will operate the motor as specified by the stop method set in F6-03 [Comm External Fault (EF0) Select].</li> </ul>			
Code	Name	Causes	Possible Solutions
EF1	External Fault (Terminal S1)	MFDI terminal S1 caused an external fault through an external device.	1. Find the device that caused the external fault and remove the cause. 2. Clear the external fault input in the MFDI.
		The wiring is incorrect.	Correctly connect the signal line to MFDI terminal S1.
		External Fault [H1-01 = 20 to 2B] is set to MFDI terminal S1, but the terminal is not in use.	Correctly set the MFDI.
<b>Note:</b> Do a Fault Reset to clear the fault.			
Code	Name	Causes	Possible Solutions
EF2	External Fault (Terminal S2)	MFDI terminal S2 caused an external fault through an external device.	1. Find the device that caused the external fault and remove the cause. 2. Clear the external fault input in the MFDI.
		The wiring is incorrect.	Correctly connect the signal line to MFDI terminal S2.

Code	Name	Causes	Possible Solutions
		<i>External Fault [H1-02 = 20 to 2B]</i> is set to MFDI terminal S2, but the terminal is not in use.	Correctly set the MFDI.
<b>Note:</b> Do a Fault Reset to clear the fault.			
Code	Name	Causes	Possible Solutions
EF3	External Fault (Terminal S3)	MFDI terminal S3 caused an external fault through an external device.	1. Find the device that caused the external fault and remove the cause. 2. Clear the external fault input in the MFDI.
		The wiring is incorrect.	Correctly connect the signal line to MFDI terminal S3.
		<i>External Fault [H1-03 = 20 to 2B]</i> is set to MFDI terminal S3, but the terminal is not in use.	Correctly set the MFDI.
<b>Note:</b> Do a Fault Reset to clear the fault.			
Code	Name	Causes	Possible Solutions
EF4	External Fault (Terminal S4)	MFDI terminal S4 caused an external fault through an external device.	1. Find the device that caused the external fault and remove the cause. 2. Clear the external fault input in the MFDI.
		The wiring is incorrect.	Correctly connect the signal line to MFDI terminal S4.
		<i>External Fault [H1-04 = 20 to 2B]</i> is set to MFDI terminal S4, but the terminal is not in use.	Correctly set the MFDI.
<b>Note:</b> Do a Fault Reset to clear the fault.			
Code	Name	Causes	Possible Solutions
EF5	External Fault (Terminal S5)	MFDI terminal S5 caused an external fault through an external device.	1. Find the device that caused the external fault and remove the cause. 2. Clear the external fault input in the MFDI.
		The wiring is incorrect.	Correctly connect the signal line to MFDI terminal S5.
		<i>External Fault [H1-05 = 20 to 2B]</i> is set to MFDI terminal S5, but the terminal is not in use.	Correctly set the MFDI.
<b>Note:</b> Do a Fault Reset to clear the fault.			
Code	Name	Causes	Possible Solutions
EF6	External Fault (Terminal S6)	MFDI terminal S6 caused an external fault through an external device.	1. Find the device that caused the external fault and remove the cause. 2. Clear the external fault input in the MFDI.
		The wiring is incorrect.	Correctly connect the signal line to MFDI terminal S6.
		<i>External Fault [H1-06 = 20 to 2B]</i> is set to MFDI terminal S6, but the terminal is not in use.	Correctly set the MFDI.
<b>Note:</b> Do a Fault Reset to clear the fault.			
Code	Name	Causes	Possible Solutions
EF7	External Fault (Terminal S7)	MFDI terminal S7 caused an external fault through an external device.	1. Find the device that caused the external fault and remove the cause. 2. Clear the external fault input in the MFDI.
		The wiring is incorrect.	Correctly connect the signal line to MFDI terminal S7.

## 6.4 Faults

Code	Name	Causes	Possible Solutions
		<i>External Fault [H1-07 = 20 to 2B]</i> is set to MFDI terminal S7, but the terminal is not in use.	Correctly set the MFDI.
<b>Note:</b> Do a Fault Reset to clear the fault.			
Code	Name	Causes	Possible Solutions
EF8	External Fault (Terminal S8)	MFDI terminal S8 caused an external fault through an external device.	1. Find the device that caused the external fault and remove the cause. 2. Clear the external fault input in the MFDI.
		The wiring is incorrect.	Correctly connect the signal line to MFDI terminal S8.
		<i>External Fault [H1-08 = 20 to 2B]</i> is set to MFDI terminal S8, but the terminal is not in use.	Correctly set the MFDI.
<b>Note:</b> Do a Fault Reset to clear the fault.			
Code	Name	Causes	Possible Solutions
Err	EEPROM Write Error	There was a problem with the EEPROM hardware.	<ul style="list-style-type: none"> <li>Re-energize the drive.</li> <li>If the fault stays, replace the control board or the drive. For information about replacing the control board, contact Yaskawa or your nearest sales representative.</li> </ul>
		Electrical interference corrupted the data while it was writing to the EEPROM of the drive.	<ul style="list-style-type: none"> <li>Push .</li> <li>Set the parameters again.</li> </ul>
<b>Note:</b> Do a Fault Reset to clear the fault.			
Code	Name	Causes	Possible Solutions
FAn	Internal Fan Fault	The circulation fan stopped operating correctly.	<ul style="list-style-type: none"> <li>Examine circulation fan operation.</li> <li>Re-energize the drive.</li> <li>Check U4-03 [Cooling Fan Ope Time] and U4-04 [Cool Fan Maintenance]. If the performance life of the circulation fan is expired or if there is damage to the fan, replace the fan.</li> </ul>
		There is a problem with the power supply of the electromagnetic contactor and the circulation fan.	<ol style="list-style-type: none"> <li>Re-energize the drive.</li> <li>If the fault stays, replace the control board or the drive. For information about replacing the control board, contact Yaskawa or your nearest sales representative.</li> </ol>
<b>Note:</b> Do a Fault Reset to clear the fault.			
Code	Name	Causes	Possible Solutions
FAn1	Drive Cooling Fan Fault	The cooling fan stopped operating correctly.	<ul style="list-style-type: none"> <li>Examine cooling fan operation.</li> <li>Re-energize the drive.</li> <li>Check U4-03 [Cooling Fan Ope Time] and U4-04 [Cool Fan Maintenance]. If the performance life of the cooling fan is expired or if there is damage to the fan, replace the fan.</li> </ul>
<b>Note:</b> Do a Fault Reset to clear the fault.			
Code	Name	Causes	Possible Solutions
FbH	Excessive PID Feedback	The <i>FbH</i> detection level is set incorrectly.	Adjust b5-36 [PID High Feedback Detection Lvl] and b5-37 [PID High Feedback Detection Time].
		There is a problem with the PID feedback wiring.	Correct errors with the PID control wiring.
		The feedback sensor is not operating correctly.	Examine the sensors on the control device side.



Code	Name	Causes	Possible Solutions
		A fault occurred in the feedback input circuit of the drive.	Replace the control board or the drive. For information about replacing the control board, contact Yaskawa or your nearest sales representative.
<b>Note:</b> <ul style="list-style-type: none"> <li>The drive detects this fault if the PID feedback input is more than the level set in <i>b5-36</i> for longer than <i>b5-37</i>.</li> <li>Do a Fault Reset to clear the fault.</li> <li>If the drive detects this fault, it will operate the motor as specified by the stop method set in <i>b5-12</i> [<i>Feedback Loss Detection Select</i>].</li> </ul>			
Code	Name	Causes	Possible Solutions
FbL	PID Feedback Loss	The <i>FbL</i> detection level is set incorrectly.	Adjust <i>b5-13</i> [ <i>PID Feedback Loss Detection Lvl</i> ] and <i>b5-14</i> [ <i>PID Feedback Loss Detection Time</i> ].
		There is a problem with the PID feedback wiring.	Correct errors with the PID control wiring.
		The feedback sensor is not operating correctly.	Examine the sensors on the control device side.
		A fault occurred in the feedback input circuit of the drive.	Replace the control board or the drive. For information about replacing the control board, contact Yaskawa or your nearest sales representative.
<b>Note:</b> <ul style="list-style-type: none"> <li>The drive detects this fault if the PID feedback input is more than the level set in <i>b5-13</i> for longer than <i>b5-14</i>.</li> <li>Do a Fault Reset to clear the fault.</li> <li>If the drive detects this fault, it will operate the motor as specified by the stop method set in <i>b5-12</i> [<i>Feedback Loss Detection Select</i>].</li> </ul>			
Code	Name	Causes	Possible Solutions
GF	Ground Fault	Overheating caused damage to the motor or the motor insulation is not satisfactory.	Measure the motor insulation resistance, and replace the motor if there is electrical conduction or unserviceable insulation.
		The motor main circuit cable is contacting ground to make a short circuit.	<ul style="list-style-type: none"> <li>Examine the motor main circuit cable for damage, and repair short circuits.</li> <li>Measure the resistance between the motor main circuit cable and the ground terminal. If there is electrical conduction, replace the cable.</li> </ul>
		An increase in the stray capacitance of the cable and the ground terminal caused an increase in the leakage current.	<ul style="list-style-type: none"> <li>If the wiring length of the cable is more than 100 m, decrease the carrier frequency.</li> <li>Decrease the stray capacitance.</li> </ul>
		There was a problem with the drive hardware.	Replace the control board or the drive. For information about replacing the control board, contact Yaskawa or your nearest sales representative.
<b>Note:</b> <ul style="list-style-type: none"> <li>The drive detects this fault if a current short to ground was more than 50% of rated current on the output side of the drive.</li> <li>Do a Fault Reset to clear the fault.</li> <li><i>L5-08</i> [<i>Fault Reset Enable Select Grp2</i>] disables the Auto Restart function.</li> </ul>			
Code	Name	Causes	Possible Solutions
LF	Output Phase Loss	The motor main circuit cable is disconnected.	Connect motor main circuit cable wiring. Correct wiring errors in the main circuit drive input power.
		There is a disconnection in the motor coil winding.	If a coil is disconnected, measure the motor Line-to-Line Resistance and replace the motor.
		The screws on the drive output terminals are loose.	Tighten the terminal screws to the correct tightening torque.
		The rated output current of the motor is less than 5% of the drive rated current.	Examine the drive capacity or the motor output to be applied.
		You are trying to use a single-phase motor.	The drive cannot operate a single-phase motor.

## 6.4 Faults

Code	Name	Causes	Possible Solutions
		The output transistor in the drive is damaged.	<ul style="list-style-type: none"> <li>Re-energize the drive.</li> <li>If the fault stays, replace the control board or the drive. For information about replacing the control board, contact Yaskawa or your nearest sales representative.</li> </ul>
<b>Note:</b> <ul style="list-style-type: none"> <li>The drive detects this fault if phase loss occurs on the output side of the drive.</li> <li>Do a Fault Reset to clear the fault.</li> <li>Set L8-07 [Output Phase Loss Protection Sel] to enable and disable LF detection.</li> </ul>			
Code	Name	Causes	Possible Solutions
LF2	Output Current Imbalance	Phase loss occurred in the wiring on the output side of the drive.	Examine for wiring errors or disconnected wires on the output side of the drive, and repair problems.
		The output terminal screws of the drive are loose.	Tighten the terminal screws to the correct tightening torque.
		There is not balance between the three phases of the PM motor impedance.	<ul style="list-style-type: none"> <li>Measure the Line-to-Line Resistance for each motor phase and make sure that resistance is equal in the three phases, and that all wires are connected correctly.</li> <li>Replace the motor.</li> </ul>
		The drive output circuit is broken.	<ul style="list-style-type: none"> <li>Re-energize the drive.</li> <li>If the fault stays, replace the control board or the drive. For information about replacing the control board, contact Yaskawa or your nearest sales representative.</li> </ul>
<b>Note:</b> <ul style="list-style-type: none"> <li>The drive detects this fault if there is not balance between the three phases of the output current from the PM motor.</li> <li>Do a Fault Reset to clear the fault.</li> </ul>			
Code	Name	Causes	Possible Solutions
LSo	Low Speed Motor Step-Out	The motor code set incorrectly.	<ul style="list-style-type: none"> <li>Set E5-01 [PM Motor Code Selection] correctly as specified by the motor.</li> <li>For specialized motors, refer to the motor test report and set E5-xx correctly.</li> </ul>
		The load is too heavy.	<ul style="list-style-type: none"> <li>Decrease the load.</li> <li>Replace the drive and motor with larger capacity models.</li> </ul>
		An external force on the load side caused the motor to move at start.	Find and repair problems on the load side that cause the motor to rotate from the load side.
		The drive incorrectly detected the motor magnetic pole position.	<ul style="list-style-type: none"> <li>Set b3-01 = 1 [Speed Search at Start Selection = Enabled].</li> <li>If the value for U6-57 [PolePolarityDeterVal] is lower than 819, increase the value set in n8-84 [Polarity Detection Current].</li> </ul>
		Incorrect values set in L8-93 [Low Speed Pull-out DetectionTime], L8-94 [Low Speed Pull-out Detect Level], and L8-95 [Low Speed Pull-out Amount].	Increase the values set in L8-93 to L8-95.
<b>Note:</b> <ul style="list-style-type: none"> <li>The drive detects this fault if it detects step-out while running at low speed.</li> <li>Do a Fault Reset to clear the fault.</li> <li>LSo is a protective function that stops the motor and stops the reverse run if a motor without a motor code incorrectly detects the initial polarity. Decrease the values set in L8-93 to L8-95 to a range in which the drive does not malfunction to quickly detect motor reversal.</li> </ul>			
Code	Name	Causes	Possible Solutions
nSE	Node Setup Error	The H1-xx = 47 [Node Setup (CANopen)] terminal was activated during run.	Stop the drive when the Node Setup function is in use.
		The drive received a Run command while the Node Setup function was active.	
<b>Note:</b> <ul style="list-style-type: none"> <li>Do a Fault Reset to clear the fault.</li> </ul>			

Code	Name	Causes	Possible Solutions
oC	Overcurrent	The load is too heavy.	<ul style="list-style-type: none"> <li>Measure the current flowing into the motor.</li> <li>Replace the drive with a larger capacity model if the current value is more than the drive rated current.</li> <li>Decrease the load or replace with a larger drive to prevent sudden changes in the current level.</li> </ul>
		Overheating caused damage to the motor or the motor insulation is not satisfactory.	Measure the motor insulation resistance, and replace the motor if there is electrical conduction or unserviceable insulation.
		The motor main circuit cable is contacting ground to make a short circuit.	<ul style="list-style-type: none"> <li>Examine the motor main circuit cable for damage, and repair short circuits.</li> <li>Measure the resistance between the motor main circuit cable and the ground terminal. If there is electrical conduction, replace the cable.</li> </ul>
		A short circuit or ground fault on the drive output side caused damage to the output transistor of the drive.	<ul style="list-style-type: none"> <li>Make sure that there is not a short circuit in terminal B1 and terminals U/T1, V/T2, and W/T3. Make sure that there is not a short circuit in terminals - and terminals U/T1, V/T2, and W/T3.</li> <li>If there is a short circuit, contact Yaskawa or your nearest sales representative.</li> </ul>
		The acceleration/deceleration time is too short.	<ul style="list-style-type: none"> <li>Calculate the torque necessary during acceleration related to the load inertia and the specified acceleration time.</li> <li>Increase the values set in C1-01, C1-03, C1-05, or C1-07 [Acceleration Times] until you get the necessary torque.</li> <li>Increase the values set in C2-01 to C2-04 [S-Curve Characteristics] until you get the necessary torque.</li> <li>Replace the drive with a larger capacity model.</li> </ul>
		The drive is trying to operate a specialized motor or a motor that is larger than the maximum applicable motor output of the drive.	<ul style="list-style-type: none"> <li>Examine the motor nameplate, the motor, and the drive to make sure that the drive rated current is larger than the motor rated current.</li> <li>Replace the drive with a larger capacity model.</li> </ul>
		A magnetic contactor was switched at the output.	Set the operation sequence to not turn ON or OFF the magnetic contactor while the drive is outputting voltage.
		The V/f pattern settings are incorrect.	<ul style="list-style-type: none"> <li>Examine the ratios between the V/f pattern frequency and voltage. Decrease the voltage if it is too high compared to the frequency.</li> <li>Adjust E1-04 to E1-10 [V/f Pattern Parameters]. For motor 2, adjust E3-04 to E3-10.</li> </ul>
		The torque compensation gain is too large.	Decrease the value set in C4-01 [Torque Compensation Gain] to make sure that the motor does not stall.
		Electrical interference caused a problem.	Examine the control circuit lines, main circuit lines, and ground wiring, and decrease the effects of electrical interference.
		The gain during overexcitation operation is set too large.	<ul style="list-style-type: none"> <li>Find the time when the fault occurs.</li> <li>If the fault occurs at the same time as overexcitation operation, decrease the value set in n3-13 [OverexcitationBraking (OEB) Gain] and consider the motor flux saturation.</li> </ul>
		The drive received a Run command while the motor was coasting.	<ul style="list-style-type: none"> <li>Examine the sequence and input the Run command after the motor fully stops.</li> <li>Set b3-01 = 1 [Speed Search at Start Selection = Enabled] or set H1-xx = 61, 62 [Speed Search from Fmax or Fref] to input speed search commands from the MFDI terminals.</li> </ul>
The motor code is set incorrectly for PM Control Methods.	<ul style="list-style-type: none"> <li>Enter the correct motor code to E5-01 [PM Motor Code Selection] as specified by the PM motor.</li> <li>For specialized motors, refer to the motor test report and set E5-xx correctly.</li> </ul>		

## 6.4 Faults

Code	Name	Causes	Possible Solutions
		Motor speed is not stable.	If $A1-02 = 6$ [Control Method Selection = PM Advanced Open Loop Vector], decrease the value set in $n8-11$ [Observer Calculation Gain 2] in increments of 10.
		The current flowing in the motor is more than the value set in $L8-27$ [Overcurrent Detection Gain] for PM Control Methods.	Correct the value set in $L8-27$ .
		The control method is set incorrectly for the motor.	Set $A1-02$ [Control Method Selection] correctly.
		The motor main circuit cable is too long.	Replace the drive with a larger capacity model.
<b>Note:</b> • This fault occurs if the drive sensors detect a drive output current more than the specified overcurrent detection level. • Do a Fault Reset to clear the fault.			
Code	Name	Causes	Possible Solutions
oFA00	Option Not Compatible with Port	The option card connected to connector CN5-A is not compatible.	Connect the option card to the correct connector. <b>Note:</b> Encoder option cards are not compatible with connector CN5-A.
<b>Note:</b> • Do a Fault Reset to clear the fault. • Fault trace is not available for this fault.			
Code	Name	Causes	Possible Solutions
oFA01	Option Fault/Connection Error	The option card connected to connector CN5-A is not compatible.	<ol style="list-style-type: none"> <li>1. De-energize the drive.</li> <li>2. Refer to the option card manual and correctly connect the option card to the connector on the drive.</li> </ol>
<b>Note:</b> Do a Fault Reset to clear the fault.			
Code	Name	Causes	Possible Solutions
oFA02	Duplicate Options	The same option cards or the same type of option cards are connected to connectors CN5-A, B, and C.	Connect the option card to the correct connector. <b>Note:</b> Use connectors CN5-C and CN5-B to connect two encoder option cards.
<b>Note:</b> Do a Fault Reset to clear the fault.			
Code	Name	Causes	Possible Solutions
oFA03 to oFA06	Option Card Error Occurred at Option Port CN5-A	A fault occurred in the option card.	<ol style="list-style-type: none"> <li>1. De-energize the drive.</li> <li>2. Make sure that the option card is correctly connected to the connector.</li> <li>3. If the problem continues, replace the option card.</li> </ol>
<b>Note:</b> Do a Fault Reset to clear the fault.			
Code	Name	Causes	Possible Solutions
oFA10, oFA11	Option Card Error Occurred at Option Port CN5-A	A fault occurred in the option card.	<ol style="list-style-type: none"> <li>1. De-energize the drive.</li> <li>2. Make sure that the option card is correctly connected to the connector.</li> <li>3. If the problem continues, replace the option card.</li> </ol>
<b>Note:</b> Do a Fault Reset to clear the fault.			

Code	Name	Causes	Possible Solutions
oFA12 to oFA17	Option Card Connection Error (CN5-A)	A fault occurred in the option card.	<ol style="list-style-type: none"> <li>1. De-energize the drive.</li> <li>2. Make sure that the option card is correctly connected to the connector.</li> <li>3. If the problem continues, replace the option card.</li> </ol>
<b>Note:</b> Do a Fault Reset to clear the fault.			
Code	Name	Causes	Possible Solutions
oFA30 to oFA43	Communication Option Card Connection Error (CN5-A)	A fault occurred in the option card.	<ol style="list-style-type: none"> <li>1. De-energize the drive.</li> <li>2. Make sure that the option card is correctly connected to the connector.</li> <li>3. If the problem continues, replace the option card.</li> </ol>
<b>Note:</b> Do a Fault Reset to clear the fault.			
Code	Name	Causes	Possible Solutions
oFb00	Option Not Compatible with Port	The option card connected to connector CN5-B is not compatible.	<p>Connect the option card to the correct connector.</p> <p><b>Note:</b> DO-A3, AO-A3, PG-B3, and PG-X3 options can connect to connector CN5-B. Use connector CN5-C when connecting only one encoder option card.</p>
<b>Note:</b> •Do a Fault Reset to clear the fault. •Fault trace is not available for this fault.			
Code	Name	Causes	Possible Solutions
oFb01	Option Fault/Connection Error	The option card connected to connector CN5-B was changed during operation.	<ol style="list-style-type: none"> <li>1. De-energize the drive.</li> <li>2. Refer to the option card manual and correctly connect the option card to the connector on the drive.</li> </ol>
<b>Note:</b> Do a Fault Reset to clear the fault.			
Code	Name	Causes	Possible Solutions
oFb02	Duplicate Options	The same option cards or the same type of option cards are connected to connectors CN5-A, B, and C.	Connect the option card to the correct connector.
<b>Note:</b> Do a Fault Reset to clear the fault.			
Code	Name	Causes	Possible Solutions
oFb03 to oFb11	Option Card Error Occurred at Option Port CN5-B	A fault occurred in the option card.	<ol style="list-style-type: none"> <li>1. De-energize the drive.</li> <li>2. Make sure that the option card is correctly connected to the connector.</li> <li>3. If the problem continues, replace the option card.</li> </ol>
<b>Note:</b> Do a Fault Reset to clear the fault.			
Code	Name	Causes	Possible Solutions
oFb12 to oFb17	Option Card Error Occurred at Option Port CN5-B	A fault occurred in the option card.	<ol style="list-style-type: none"> <li>1. De-energize the drive.</li> <li>2. Make sure that the option card is correctly connected to the connector.</li> <li>3. If the problem continues, replace the option card.</li> </ol>
<b>Note:</b> Do a Fault Reset to clear the fault.			

## 6.4 Faults

Code	Name	Causes	Possible Solutions
oFC00	Option Not Compatible with Port	The option card connected to connector CN5-C is not compatible.	Connect the option card to the correct connector. <b>Note:</b> AI-A3, DI-A3, and communication option cards cannot be connected to the CN5-C connector.
<b>Note:</b> • Do a Fault Reset to clear the fault. • Fault trace is not available for this fault.			
Code	Name	Causes	Possible Solutions
oFC01	Option Fault/Connection Error	The option card connected to connector CN5-C was changed during operation.	1. De-energize the drive. 2. Refer to the option card manual and correctly connect the option card to the connector on the drive.
<b>Note:</b> Do a Fault Reset to clear the fault.			
Code	Name	Causes	Possible Solutions
oFC02	Duplicate Options	The same option cards or the same type of option cards are connected to connectors CN5-A, B, and C.	Connect the option card to the correct connector.
<b>Note:</b> Do a Fault Reset to clear the fault.			
Code	Name	Causes	Possible Solutions
oFC03 to oFC11	Option Card Error Occurred at Option Port CN5-C	A fault occurred in the option card.	1. De-energize the drive. 2. Make sure that the option card is correctly connected to the connector. 3. If the problem continues, replace the option card.
<b>Note:</b> Do a Fault Reset to clear the fault.			
Code	Name	Causes	Possible Solutions
oFC12 to oFC17	Option Card Error Occurred at Option Port CN5-C	A fault occurred in the option card.	1. De-energize the drive. 2. Make sure that the option card is correctly connected to the connector. 3. If the problem continues, replace the option card.
<b>Note:</b> Do a Fault Reset to clear the fault.			
Code	Name	Causes	Possible Solutions
oFC50 to oFC55	Option Card Error Occurred at Option Port CN5-C	A fault occurred in the option card.	Refer to the manual for the PG-RT3 or PG-F3 option card.
<b>Note:</b> Do a Fault Reset to clear the fault.			
Code	Name	Causes	Possible Solutions
oH	Heatsink Overheat	The ambient temperature is high and the heatsink temperature of the drive is more than the value set in L8-02 [Overheat Alarm Level].	<ul style="list-style-type: none"> <li>• Measure the ambient temperature.</li> <li>• Increase the airflow in the control panel.</li> <li>• Install a cooling device (cooling fan or air conditioner) to lower the ambient temperature.</li> <li>• Remove objects near the drive that are producing too much heat.</li> </ul>
		The load is too heavy.	<ul style="list-style-type: none"> <li>• Measure the output current.</li> <li>• Decrease the load.</li> <li>• Decrease the value set in C6-02 [Carrier Frequency Selection].</li> </ul>

Code	Name	Causes	Possible Solutions
		The internal cooling fan of the drive stopped.	<ol style="list-style-type: none"> <li>1. Use the procedure in this manual to replace cooling fan.</li> <li>2. Set <math>o4-03 = 0</math> [<i>Fan Operation Time Setting = 0 h</i>].</li> </ol>
<p><b>Note:</b></p> <ul style="list-style-type: none"> <li>• The drive detects this fault if the heatsink temperature of the drive is more than the value set in <i>L8-02</i>.</li> <li>• Do a Fault Reset to clear the fault.</li> <li>• If the drive detects this fault, it will operate the motor as specified by the Stopping Method set in <i>L8-03</i> [<i>Overheat Pre-Alarm Selection</i>].</li> </ul>			
Code	Name	Causes	Possible Solutions
oH1	Heatsink Overheat	The ambient temperature is high and the heatsink temperature of the drive is more than the value set in <i>L8-02</i> [ <i>Overheat Alarm Level</i> ].	<ul style="list-style-type: none"> <li>• Measure the ambient temperature.</li> <li>• Increase the airflow in the control panel.</li> <li>• Install a cooling device (cooling fan or air conditioner) to lower the ambient temperature.</li> <li>• Remove objects near the drive that are producing too much heat.</li> </ul>
		The load is too heavy.	<ul style="list-style-type: none"> <li>• Measure the output current.</li> <li>• Decrease the load.</li> <li>• Decrease the value set in <i>C6-02</i> [<i>Carrier Frequency Selection</i>].</li> </ul>
<p><b>Note:</b></p> <ul style="list-style-type: none"> <li>• The drive detects this fault if the heatsink temperature of the drive is more than the <i>oH1</i> detection level. <i>o2-04</i> [<i>Drive Model (KVA Selection)</i>] determines the <i>oH1</i> detection level.</li> <li>• Do a Fault Reset to clear the fault.</li> <li>• <i>L5-08</i> [<i>Fault Reset Enable Select Grp2</i>] disables the Auto Restart function.</li> </ul>			
Code	Name	Causes	Possible Solutions
oH3	Motor Overheat (PTC Input)	The thermistor wiring that detects motor temperature is defective.	Correct any wiring errors.
		A fault occurred on the machine side. Example: The machine is locked.	Examine the machine and remove the cause of the fault.
		The motor has overheated.	<ul style="list-style-type: none"> <li>• Check the load level, acceleration/deceleration time, and motor start/stop frequency (cycle time).</li> <li>• Decrease the load.</li> <li>• Increase the values set in <i>C1-01</i> to <i>C1-08</i> [<i>Acceleration/Deceleration Times</i>].</li> <li>• Set <i>E2-01</i> [<i>Motor Rated Current (FLA)</i>] correctly to the value specified by the motor nameplate.</li> <li>• Make sure that the motor cooling system is operating correctly, and repair or replace it if it is damaged.</li> <li>• Adjust <i>E1-04</i> to <i>E1-10</i> [<i>V/f Pattern Parameters</i>]. For motor 2, adjust <i>E3-04</i> to <i>E3-10</i>. Decrease the values set in <i>E1-08</i> [<i>Mid Point A Voltage</i>] and <i>E1-10</i> [<i>Minimum Output Voltage</i>].</li> </ul> <p><b>Note:</b> If <i>E1-08</i> and <i>E1-10</i> are set too low, the overload tolerance will decrease at low speeds.</p>
<p><b>Note:</b></p> <ul style="list-style-type: none"> <li>• The drive detects this fault if the motor overheat signal that was entered to an analog input terminals A1, A2, or A3 is more than the alarm detection level. (If <i>H3-02</i>, <i>H3-10</i>, or <i>H3-06 = E</i> [<i>MFAI Function Select = Motor Temperature (PTC Input)</i>] was set.)</li> <li>• Do a Fault Reset to clear the fault.</li> <li>• If the drive detects this fault, it will operate the motor as specified by the Stopping Method set in <i>L1-03</i> [<i>Motor Thermistor oH Alarm Select</i>].</li> </ul>			

## 6.4 Faults

Code	Name	Causes	Possible Solutions
oH4	Motor Overheat Fault (PTC Input)	The motor has overheated.	<ul style="list-style-type: none"> <li>Check the load level, acceleration/deceleration time, and motor start/stop frequency (cycle time).</li> <li>Decrease the load.</li> <li>Increase the values set in <i>C1-01 to C1-08 [Acceleration/Deceleration Times]</i>.</li> <li>Set <i>E2-01 [Motor Rated Current (FLA)]</i> correctly to the value specified by the motor nameplate.</li> <li>Make sure that the motor cooling system is operating correctly, and repair or replace it if it is damaged.</li> <li>Adjust <i>E1-04 to E1-10 [V/f Pattern Parameters]</i>. For motor 2, adjust <i>E3-04 to E3-10</i>. Decrease the values set in <i>E1-08 [Mid Point A Voltage]</i> and <i>E1-10 [Minimum Output Voltage]</i>.</li> </ul> <p><b>Note:</b> If <i>E1-08</i> and <i>E1-10</i> are set too low, the overload tolerance will decrease at low speeds.</p>
<p><b>Note:</b></p> <ul style="list-style-type: none"> <li>The drive detects this fault if the motor overheat signal that was entered to an analog input terminals A1, A2, or A3 is more than the alarm detection level. (If <i>H3-02</i>, <i>H3-10</i>, or <i>H3-06 = E [MFAI Function Select = Motor Temperature (PTC Input)]</i> was set.)</li> <li>Do a Fault Reset to clear the fault.</li> </ul>			
Code	Name	Causes	Possible Solutions
oL1	Motor Overload	The load is too heavy.	Decrease the load. <p><b>Note:</b> Reset <i>oL1</i> when <i>U4-16 [Motor oL1 Level] &lt; 100</i>.</p>
		The acceleration/deceleration times or cycle times are too short.	<ul style="list-style-type: none"> <li>Examine the acceleration/deceleration times and the motor start/stop frequencies (cycle times).</li> <li>Increase the value set in <i>C1-01 to C1-08 [Acceleration/Deceleration Times]</i>.</li> </ul>
		Overload occurred while running at low speed.	<ul style="list-style-type: none"> <li>Lower the load when running at low speed.</li> <li>Increase the motor speed.</li> <li>If the motor is run frequently at low speeds, replace the motor with a larger motor or use a drive-dedicated motor.</li> </ul> <p><b>Note:</b> For general-purpose motors, overload can occur while running at low speed when operating at below the rated current.</p>
		<i>L1-01 [Motor Overload (oL1) Protection]</i> is set incorrectly.	Set <i>L1-01</i> in as specified by the motor qualities for a drive-dedicated motor.
		The V/f pattern does not fit the motor qualities.	<ul style="list-style-type: none"> <li>Examine the ratios between the V/f pattern frequency and voltage. Decrease the voltage if it is too high compared to the frequency.</li> <li>Adjust <i>E1-04 to E1-10 [V/f Pattern Parameters]</i>. For motor 2, adjust <i>E3-04 to E3-10</i>. Decrease the values set in <i>E1-08 [Mid Point A Voltage]</i> and <i>E1-10 [Minimum Output Voltage]</i>.</li> </ul> <p><b>Note:</b> If <i>E1-08</i> and <i>E1-10</i> are set too low, the overload tolerance will decrease at low speeds.</p>
		<i>E1-06 [Base Frequency]</i> is set incorrectly.	Set <i>E1-06</i> to the rated frequency shown on the motor nameplate.
		One drive is operating more than one motor.	Set <i>L1-01 = 0 [Motor Overload (oL1) Protection = Disabled]</i> , connect thermal overload relay to each motor to prevent damage to the motor.
		The electronic thermal protector qualities and the motor overload properties do not match.	<ul style="list-style-type: none"> <li>Examine the motor qualities and set <i>L1-01 [Motor Overload (oL1) Protection]</i> correctly.</li> <li>Connect a thermal overload relay to the motor.</li> </ul>
The electronic thermal protector is operating at an incorrect level.	Set <i>E2-01 [Motor Rated Current (FLA)]</i> to the value shown on the motor nameplate.		



Code	Name	Causes	Possible Solutions
		There is increased motor loss from overexcitation operation.	<ul style="list-style-type: none"> <li>Lower the value set in <i>n3-13</i> [<i>OverexcitationBraking (OEB) Gain</i>].</li> <li>Set <i>L3-04</i> <math>\neq</math> 4 [<i>Stall Prevention during Decel <math>\neq</math> Overexcitation/High Flux</i>].</li> <li>Set <i>n3-23</i> = 0 [<i>Overexcitation Braking Operation = Disabled</i>].</li> </ul>
		The speed search-related parameters are set incorrectly.	<ul style="list-style-type: none"> <li>Examine the settings for all speed search related parameters.</li> <li>Adjust <i>b3-03</i> [<i>Speed Search Deceleration Time</i>].</li> <li>Set <i>b3-24</i> = 1 [<i>Speed Search Method Selection = Speed Estimation</i>] after Auto-Tuning.</li> </ul>
		Phase loss in the input power supply is causing the output current to change.	Make sure that there is no phase loss, and repair problems.

**Note:**

- The drive detects this fault if the electronic thermal protector of the drive started the motor overload protection.
- Do a Fault Reset to clear the fault.
- L5-07* [*Fault Reset Enable Select Grp1*] disables the Auto Restart function.

Code	Name	Causes	Possible Solutions
oL2	Drive Overload	The load is too heavy.	Decrease the load.
		The acceleration/deceleration times or cycle times are too short.	<ul style="list-style-type: none"> <li>Examine the acceleration/deceleration times and the motor start/stop frequencies (cycle times).</li> <li>Increase the value set in <i>C1-01</i> to <i>C1-08</i> [<i>Acceleration/Deceleration Times</i>].</li> </ul>
		The V/f pattern does not fit the motor qualities.	<ul style="list-style-type: none"> <li>Examine the ratios between the V/f pattern frequency and voltage. Lower the voltage if it is too high compared to the frequency.</li> <li>Adjust <i>E1-04</i> to <i>E1-10</i> [<i>V/f Pattern Parameters</i>]. Lower the values set in <i>E1-08</i> [<i>Mid Point A Voltage</i>] and <i>E1-10</i> [<i>Minimum Output Voltage</i>] For motor 2, adjust <i>E3-04</i> to <i>E3-10</i>.</li> </ul> <p><b>Note:</b> If <i>E1-08</i> and <i>E1-10</i> are set too low, the overload tolerance is will decrease at low speeds.</p>
		The drive capacity is too small.	Replace the drive with a larger capacity model.
		Overload occurred while running at low speed.	<ul style="list-style-type: none"> <li>Decrease the load when running at low speed.</li> <li>Replace the drive with a larger capacity model.</li> <li>Decrease the value set in <i>C6-02</i> [<i>Carrier Frequency Selection</i>].</li> </ul>
		The torque compensation gain is too large.	Decrease the value set in <i>C4-01</i> [ <i>Torque Compensation Gain</i> ] to make sure that the motor does not stall.
		The speed search-related parameters are set incorrectly.	<ul style="list-style-type: none"> <li>Examine the settings for all speed search related parameters.</li> <li>Adjust <i>b3-03</i> [<i>Speed Search Deceleration Time</i>].</li> <li>Set <i>b3-24</i> = 1 [<i>Speed Search Method Selection = Speed Estimation</i>] after Auto-Tuning.</li> </ul>
		Phase loss in the input power supply is causing the output current to change.	<ul style="list-style-type: none"> <li>Correct any wiring errors in the main circuit drive input power.</li> <li>Make sure that there is no phase loss, and repair problems.</li> </ul>

**Note:**

- The drive detects this fault if the electronic thermal protector of the drive started the motor overload protection.
- Do a Fault Reset to clear the fault.
- L5-07* [*Fault Reset Enable Select Grp1*] disables the Auto Restart function.

## 6.4 Faults

Code	Name	Causes	Possible Solutions
oL3	Overtorque Detection 1	A fault occurred on the machine. Example: The machine is locked.	Examine the machine and remove the cause of the fault.
		The parameters are incorrect for the load.	Adjust L6-02 [Torque Detection Level 1] and L6-03 [Torque Detection Time 1] settings.
<b>Note:</b> <ul style="list-style-type: none"> <li>The drive detects this fault if the drive output current is more than the level set in L6-02 for longer than L6-03.</li> <li>Do a Fault Reset to clear the fault.</li> <li>If the drive detects this fault, it will operate the motor as specified by the Stopping Method set in L6-01 [Torque Detection Selection 1].</li> <li>L5-07 [Fault Reset Enable Select Grp1] disables the Auto Restart function.</li> </ul>			
Code	Name	Causes	Possible Solutions
oL4	Overtorque Detection 2	A fault occurred on the machine. Example: The machine is locked.	Examine the machine and remove the cause of the fault.
		The parameters are incorrect for the load.	Adjust L6-05 [Torque Detection Level 2] and L6-06 [Torque Detection Time 2] settings.
<b>Note:</b> <ul style="list-style-type: none"> <li>The drive detects this fault if the drive output current is more than the level set in L6-05 for longer than L6-06.</li> <li>Do a Fault Reset to clear the fault.</li> <li>If the drive detects this fault, it will operate the motor as specified by the Stopping Method set in L6-04 [Torque Detection Selection 2].</li> <li>L5-07 [Fault Reset Enable Select Grp1] disables the Auto Restart function.</li> </ul>			
Code	Name	Causes	Possible Solutions
oL5	Mechanical Weakening Detection 1	The drive detected overtorque as specified by the conditions for mechanical weakening detection set in L6-08 [Mechanical Fatigue Detect Select].	Do a deterioration diagnostic test on the machine side.
<b>Note:</b> <ul style="list-style-type: none"> <li>Do a Fault Reset to clear the fault.</li> <li>If the drive detects this fault, it will operate the motor as specified by the Stopping Method set in L6-08.</li> </ul>			
Code	Name	Causes	Possible Solutions
oL7	High Slip Braking Overload	The load inertia is too large.	<ul style="list-style-type: none"> <li>Decrease deceleration times in C1-02, C1-04, C1-06, and C1-08 [Deceleration Times] for applications that do not use High Slip Braking.</li> <li>Use a braking resistor to decrease the deceleration time.</li> </ul>
		An external force on the load side rotated the motor.	
		Something is preventing deceleration on the load side.	
		The value set in n3-04 [HSB Overload Time] is too small.	<ul style="list-style-type: none"> <li>Increase the value set in n3-04.</li> <li>Connect a thermal overload relay to the motor, and set n3-04 = 1200 s (maximum value).</li> </ul>
<b>Note:</b> <ul style="list-style-type: none"> <li>The drive detects this fault if the output frequency is constant for longer than n3-04.</li> <li>Do a Fault Reset to clear the fault.</li> </ul>			
Code	Name	Causes	Possible Solutions
oPr	Keypad Connection Fault	The keypad is not securely connected to the connector on the drive.	Examine the connection between the keypad and the drive.
		The connection cable between the drive and the keypad is disconnected.	<ul style="list-style-type: none"> <li>Remove the keypad and connect it again.</li> <li>If the cable is damaged, replace it.</li> </ul>
<b>Note:</b> <ul style="list-style-type: none"> <li>The drive detects this fault if these conditions are correct: <ul style="list-style-type: none"> <li>-o2-06 = 1 [Keypad Disconnect Detection = Enabled].</li> <li>-b1-02 = 0 [Run Command Selection 1 = Keypad], or the drive is operating in LOCAL Mode with the keypad.</li> </ul> </li> <li>Do a Fault Reset to clear the fault.</li> </ul>			
Code	Name	Causes	Possible Solutions
oS	Overspeed	There is overshoot.	<ul style="list-style-type: none"> <li>Decrease C5-01 [ASR Proportional Gain 1] and increase C5-02 [ASR Integral Time 1].</li> <li>Adjust the pulse train gain with H6-02 to H6-05 [Pulse Train Input Setting Parameters].</li> </ul>
		There is an incorrect number of PG pulses set in the drive.	Set H6-02 [Terminal RP Frequency Scaling] to the pulse train frequency during 100% reference (maximum motor rotation speed).

Code	Name	Causes	Possible Solutions
		The $\alpha S$ detection level is set incorrectly.	Adjust <i>F1-08 [Overspeed Detection Level]</i> and <i>F1-09 [Overspeed Detection Delay Time]</i> .
<p><b>Note:</b></p> <ul style="list-style-type: none"> <li>The drive detects this fault if the motor speed is more than the value set in <i>F1-08</i> for longer than <i>F1-09</i>.</li> <li>Do a Fault Reset to clear the fault.</li> <li>If the drive detects this fault, it will operate the motor as specified by the Stopping Method set in <i>F1-03 [Overspeed Detection Selection]</i>.</li> </ul>			
Code	Name	Causes	Possible Solutions
ov	Overvoltage	Deceleration time is too short and regenerative energy is flowing from the motor into the drive.	<ul style="list-style-type: none"> <li>Set <i>L3-04 = 1 [Stall Prevention during Decel = General Purpose]</i>.</li> <li>Increase the value set in <i>C1-02, C1-04, C1-06, or C1-08 [Deceleration Time]</i>.</li> <li>Connect a dynamic braking option to the drive.</li> <li>Perform Deceleration Rate Tuning.</li> </ul>
		The acceleration time is too short.	<ul style="list-style-type: none"> <li>Make sure that sudden drive acceleration does not cause the fault.</li> <li>Increase the value set in <i>C1-01, C1-03, C1-05, or C1-07 [Acceleration Time]</i>.</li> <li>Increase the value set in <i>C2-02 [S-Curve Time @ End of Accel]</i>.</li> <li>Set <i>L3-11 = 1 [Overvoltage Suppression Select = Enabled]</i>.</li> </ul>
		The braking load is too large.	Connect a dynamic braking option to the drive.
		There are surge voltages in the input power supply.	Connect a DC reactor to the drive. <b>Note:</b> If you turn the phase advancing capacitors ON and OFF and use thyristor converters in the same power supply system, there can be surge voltages that irregularly increase the input voltage.
		The drive output cable or motor is shorted to ground (the current short to ground is charging the main circuit capacitor of the drive through the power supply).	<ol style="list-style-type: none"> <li>Examine the motor main circuit cable, terminals, and motor terminal box, and then remove ground faults.</li> <li>Re-energize the drive.</li> </ol>
		The speed search-related parameters are set incorrectly (this fault also occurs during recovery from momentary power loss and after Auto Restarts).	<ul style="list-style-type: none"> <li>Examine the settings for all speed search-related parameters.</li> <li>Set <i>b3-19 <math>\neq</math> 0 [Speed Search Restart Attempts <math>\neq</math> 0 times]</i>.</li> <li>Adjust <i>b3-03 [Speed Search Deceleration Time]</i>.</li> <li>Do Stationary Auto-Tuning for Line-to-Line Resistance and then set <i>b3-24 = 1 [Speed Search Method Selection = Speed Estimation]</i>.</li> </ul>
		The power supply voltage is too high.	Decrease the power supply voltage to match the drive rated voltage.
		The braking resistor or braking resistor unit wiring is incorrect.	Correct wiring errors in the connection to the braking resistor or braking resistor unit.
		The encoder cable is disconnected or wired incorrectly.	Examine for wiring errors or disconnected wires in the encoder cable, and repair problems.
		Electrical interference along the encoder cable.	Isolate the encoder cable from the drive output line or a different source of electrical interference.
Electrical interference caused a drive malfunction.	<ul style="list-style-type: none"> <li>Examine the control circuit lines, main circuit lines, and ground wiring, and decrease the effects of electrical interference.</li> <li>Make sure that a magnetic contactor is not the source of the electrical interference, then use a Surge Protective Device if necessary.</li> </ul>		
The load inertia is set incorrectly.	<ul style="list-style-type: none"> <li>Examine the load inertia settings with KEB, overvoltage suppression, or stall prevention during deceleration.</li> <li>Adjust <i>L3-25 [Load Inertia Ratio]</i> to match the qualities of the machine.</li> </ul>		

## 6.4 Faults

Code	Name	Causes	Possible Solutions
		The Short Circuit Braking function used in OLV/PM control method.	Connect a braking resistor to the drive.
		There is motor hunting.	<ul style="list-style-type: none"> <li>Adjust <i>n1-02</i> [<i>Hunting Prevention Gain Setting</i>].</li> <li>Adjust <i>n2-02</i> [<i>Automatic Freq Regulator Time 1</i>] and <i>n2-03</i> [<i>Automatic Freq Regulator Time 2</i>].</li> <li>Adjust <i>n8-45</i> [<i>Speed Feedback Detection Gain</i>] and <i>n8-47</i> [<i>Pull-in Current Comp Filter Time</i>].</li> </ul>

**Note:**

- The drive detects this error if the DC bus voltage is more than the *ov* detection level while the drive is running.
- Do a Fault Reset to clear the fault.
- The *ov* detection level is approximately 410 V with 200 V class drives. The detection level is approximately 820 V with 400 V class drives.
- L5-08* [*Fault Reset Enable Select Grp2*] disables the Auto Restart function.

Code	Name	Causes	Possible Solutions
PF	Input Phase Loss	There is a phase loss in the drive input power.	Correct errors with the wiring for main circuit drive input power.
		There is loose wiring in the drive input power terminals.	Tighten the terminal screws to the correct tightening torque.
		The drive input power voltage is changing too much.	<ul style="list-style-type: none"> <li>Examine the input power for problems.</li> <li>Make the drive input power stable.</li> <li>If the input power supply is good, examine the magnetic contactor on the main circuit side for problems.</li> </ul>
		There is unsatisfactory balance between voltage phases.	<ul style="list-style-type: none"> <li>Examine the input power for problems.</li> <li>Make the drive input power stable.</li> <li>Set <i>L8-05</i> = 0 [<i>Input Phase Loss Protection Sel = Disabled</i>].</li> </ul>
		The main circuit capacitors have become unserviceable.	<ul style="list-style-type: none"> <li>Examine the capacitor maintenance time in monitor <i>U4-05</i> [<i>Capacitor Maintenance</i>]. If <i>U4-05</i> is more than 90%, replace the control board or the drive. For information about replacing the control board, contact Yaskawa or your nearest sales representative.</li> <li>If drive input power is correct and the fault stays, replace the control board or the drive. For information about replacing the control board, contact Yaskawa or your nearest sales representative.</li> </ul>

**Note:**

- The drive detects this error if the DC bus voltage changes irregularly without regeneration.
- Do a Fault Reset to clear the fault.
- Use *L8-05* to enable and disable *PF* detection.

Code	Name	Causes	Possible Solutions
PGo	Encoder (PG) Feedback Loss	The encoder cable is disconnected or wired incorrectly.	Examine for wiring errors or disconnected wires in the encoder cable, and repair problems.
		The encoder is not receiving power.	Examine the encoder power supply.
		The holding brake is stopping the motor.	Release the holding brake.

**Note:**

- The drive detects this error if it does not receive the speed detection pulse signal from the encoder in the detection time set in *F1-14* [*Encoder Open-Circuit Detect Time*].
- Do a Fault Reset to clear the fault.
- If the drive detects this error, it will operate the motor as specified by the Stopping Method set in *F1-02* [*PG Open Circuit Detection Select*].

Code	Name	Causes	Possible Solutions
PGoH	Encoder (PG) Hardware Fault	The encoder cable is disconnected.	Connect all encoder cable wires.

**Note:**

- Do a Fault Reset to clear the fault.
- If the drive detects this error, it will operate the motor as specified by the Stopping Method set in *F1-02* [*PG Open Circuit Detection Select*].

Code	Name	Causes	Possible Solutions
rF	Braking Resistor Fault	The resistance of the dynamic braking option that is connected to the drive is too low.	Use a dynamic braking option that fits the model and duty rating of the drive.
		A regenerative converter, regenerative unit, or braking unit is connected to the drive.	Set $L8-55 = 0$ [ <i>Internal DB TransistorProtection = Disable</i> ].
<b>Note:</b> Do a Fault Reset to clear the fault.			
Code	Name	Causes	Possible Solutions
rH	Braking Resistor Overheat	The deceleration time is too short and excessive regenerative energy is flowing back into the drive.	<ul style="list-style-type: none"> <li>Check the load level, deceleration time, and speed.</li> <li>Decrease the load.</li> <li>Increase the value set in <i>C1-02</i>, <i>C1-04</i>, <i>C1-06</i>, or <i>C1-08</i> [<i>Deceleration Times</i>].</li> <li>Use a dynamic braking option that lets you use more power.</li> </ul>
		The duty cycle is too high.	Examine the duty cycle. <b>Note:</b> When $L8-01 = 1$ [ <i>3% ERF DB Resistor Protection = Enabled</i> ], the maximum braking duty cycle is 3%.
		The braking load is too large.	<ul style="list-style-type: none"> <li>Calculate the braking load and braking power again, and decrease the braking load.</li> <li>Use a braking resistor that improves braking power.</li> </ul>
		The braking resistor is not sufficient.	Use the braking resistor specifications to select a sufficient braking resistor.
<b>Note:</b> <ul style="list-style-type: none"> <li>The drive detects this error if the braking resistor overheat protective function is active.</li> <li>The magnitude of the braking load causes the braking resistor overheat alarm, NOT the surface temperature. If the duty cycle is higher than the braking resistor rating, the drive will show the alarm.</li> <li>Do a Fault Reset to clear the fault.</li> <li><i>L8-01</i> enables fault detection.</li> </ul>			
Code	Name	Causes	Possible Solutions
rr	Dynamic Braking Transistor Fault	The drive control circuit is damaged.	<ul style="list-style-type: none"> <li>Re-energize the drive.</li> <li>If the fault stays, replace the control board or the drive. For information about replacing the control board, contact Yaskawa or your nearest sales representative.</li> </ul>
		There is a malfunction in the internal braking transistor of the drive.	
<b>Note:</b> Do a Fault Reset to clear the fault.			
Code	Name	Causes	Possible Solutions
SC	Short Circuit/IGBT Failure	Overheating caused damage to the motor or the motor insulation is not satisfactory.	Measure the motor insulation resistance, and replace the motor if there is electrical conduction or unserviceable insulation.
		The motor main circuit cable is contacting ground to make a short circuit.	<ul style="list-style-type: none"> <li>Examine the motor main circuit cable for damage, and repair short circuits.</li> <li>Measure the resistance between the motor main circuit cable and the ground terminal. If there is electrical conduction, replace the cable.</li> </ul>
		A short circuit or ground fault on the drive output side caused damage to the output transistor of the drive.	<ul style="list-style-type: none"> <li>Make sure that there is not a short circuit in terminal B1 and terminals U/T1, V/T2, and W/T3. Make sure that there is not a short circuit in terminals - and terminals U/T1, V/T2, and W/T3.</li> <li>If there is a short circuit, contact Yaskawa or your nearest sales representative.</li> </ul>
<b>Note:</b> <ul style="list-style-type: none"> <li>The drive detects this error if there is a short circuit or ground fault on the drive output side, or an IGBT failure.</li> <li>Do a Fault Reset to clear the fault.</li> </ul>			

## 6.4 Faults

Code	Name	Causes	Possible Solutions
SCF	Safety Circuit Fault	The safety circuit is broken.	Replace the control board or the drive. For information about replacing the control board, contact Yaskawa or your nearest sales representative.

**Note:**

Do a Fault Reset to clear the fault.

Code	Name	Causes	Possible Solutions
SEr	Speed Search Retries Exceeded	The speed search-related parameters are set incorrectly.	<ul style="list-style-type: none"> <li>Decrease the value set in <i>b3-10</i> [Speed Estimation Detection Gain].</li> <li>Increase the value set in <i>b3-17</i> [Speed Est Retry Current Level].</li> <li>Increase the value set in <i>b3-18</i> [Speed Est Retry Detection Time].</li> <li>Do Auto-Tuning again.</li> </ul>
		The motor is coasting in the opposite direction of the Run command.	Set <i>b3-14</i> = 1 [Bi-directional Speed Search = Enabled].

**Note:**

- The drive detects this error if the number of speed search restarts is more than the value set in *b3-19* [Speed Search Restart Attempts].
- Do a Fault Reset to clear the fault.

Code	Name	Causes	Possible Solutions
STPo	Motor Step-Out Detected	The motor code is set incorrectly for PM Control Methods.	<ul style="list-style-type: none"> <li>Enter the correct motor code to <i>E5-01</i> [PM Motor Code Selection] as specified by the PM motor.</li> <li>For specialized motors, refer to the motor test report and set <i>E5-xx</i> correctly.</li> </ul>
		The load is too heavy.	<ul style="list-style-type: none"> <li>Increase the value set in <i>n8-55</i> [Motor to Load Inertia Ratio].</li> <li>Increase the value set in <i>n8-51</i> [Pull-in Current @ Acceleration]. If the drive detects <i>STPo</i> during deceleration when increasing the value set in <i>n8-51</i>, set the value of <i>n8-79</i> [Pull-in Current @ Deceleration] lower than <i>n8-51</i>.</li> <li>Decrease the load.</li> <li>Replace the drive and motor with larger capacity models.</li> </ul>
		The load inertia is too heavy.	Increase the value set in <i>n8-55</i> .
		The acceleration/deceleration times are too short.	<ul style="list-style-type: none"> <li>Increase the acceleration/deceleration times set in <i>C1-01</i> to <i>C1-08</i> [Acceleration/Deceleration Time].</li> <li>Increase the value set in <i>C2-01</i> [S-Curve Time @ Start of Accel].</li> </ul>
		Speed response is too slow.	<ul style="list-style-type: none"> <li>Increase the value set in <i>n8-55</i>.</li> <li>If <i>STPo</i> occurs in Normal Duty mode when <i>A1-02</i> = 6 [Control Method Selection = PM Advanced Open Loop Vector], increase the value set in <i>n8-11</i> [Observer Calculation Gain 2] in increments of 10. If <i>STPo</i> occurs when starting a motor, decrease the value set in <i>n8-11</i> in increments of 10.</li> </ul>

**Note:**

Do a Fault Reset to clear the fault.

Code	Name	Causes	Possible Solutions
SvE	Zero Servo Fault	The value set in the torque limit is too small.	Adjust torque limit-related parameters <i>L7-01</i> to <i>L7-04</i> .
		The load torque is too large.	Decrease the load torque.
		Noise interference along the encoder cable	Isolate the encoder cable from the drive output line or a different source of electrical interference.

**Note:**

- The drive detects this error if motor rotation position moves during Zero Servo.
- Do a Fault Reset to clear the fault.

Code	Name	Causes	Possible Solutions
TiM	Keypad Time Not Set	There is a battery in the keypad, but the date and time are not set.	Set the date and time with the keypad.
<b>Note:</b> <ul style="list-style-type: none"> <li>Do a Fault Reset to clear the fault.</li> <li>o4-24 [bAT Detection Selection] enables and disables TiM detection.</li> </ul>			
Code	Name	Causes	Possible Solutions
UL3	Undertorque Detection 1	A fault occurred on the machine. Example: There is a broken pulley belt.	Examine the machine and remove the cause of the fault.
		The parameters are incorrect for the load.	Adjust L6-02 [Torque Detection Level 1] and L6-03 [Torque Detection Time 1] settings.
<b>Note:</b> <ul style="list-style-type: none"> <li>The drive detects this error if the drive output current is less than the level set in L6-02 for longer than L6-03.</li> <li>Do a Fault Reset to clear the fault.</li> <li>If the drive detects this error, it will operate the motor as specified by the Stopping Method set in L6-01 [Torque Detection Selection 1].</li> </ul>			
Code	Name	Causes	Possible Solutions
UL4	Undertorque Detection 2	A fault occurred on the machine. Example: There is a broken pulley belt.	Examine the machine and remove the cause of the fault.
		The parameters are incorrect for the load.	Adjust L6-05 [Torque Detection Level 2] and L6-06 [Torque Detection Time 2] settings.
<b>Note:</b> <ul style="list-style-type: none"> <li>The drive detects this error if the drive output current is less than the level set in L6-05 for longer than L6-06.</li> <li>Do a Fault Reset to clear the fault.</li> <li>If the drive detects this error, it will operate the motor as specified by the Stopping Method set in L6-04 [Torque Detection Selection 2].</li> </ul>			
Code	Name	Causes	Possible Solutions
UL5	Mechanical Weakening Detection 2	The drive detected undertorque as specified by the conditions for mechanical weakening detection set in L6-08 [Mechanical Fatigue Detect Select].	Examine the machine for deterioration.
<b>Note:</b> <ul style="list-style-type: none"> <li>Do a Fault Reset to clear the fault.</li> <li>If the drive detects this error, it will operate the motor as specified by the Stopping Method set in L6-08.</li> </ul>			
Code	Name	Causes	Possible Solutions
Uv1	DC Bus Undervoltage	There is a phase loss in the drive input power.	Correct errors with the wiring for main circuit drive input power.
		There is loose wiring in the drive input power terminals.	Tighten the terminal screws to the correct tightening torque.
		The drive input power voltage is changing too much.	<ul style="list-style-type: none"> <li>Examine the input power for problems.</li> <li>Make the drive input power stable.</li> <li>If the input power supply is good, examine the magnetic contactor on the main circuit side for problems.</li> </ul>
		There was a loss of power.	Use a better power supply.
		The main circuit capacitors have become unserviceable.	Examine the capacitor maintenance time in monitor U4-05 [Capacitor Maintenance]. If U4-05 is more than 90%, replace the control board or the drive. For information about replacing the control board, contact Yaskawa or your nearest sales representative.

## 6.4 Faults

Code	Name	Causes	Possible Solutions
		The relay or contactor on the soft-charge bypass relay is damaged.	<i>U4-06 [PreChargeRelayMainte]</i> shows the performance life of the soft-charge bypass relay. If <i>U4-06</i> is more than 90%, replace the board or the drive. For information about replacing the board, contact Yaskawa or your nearest sales representative.
<p><b>Note:</b></p> <ul style="list-style-type: none"> <li>The drive detects this error if the DC bus voltage decreases below the level set in <i>L2-05 [Undervoltage Detection Lvl (Uv1)]</i> while the drive is running.</li> <li>The <i>Uv1</i> detection level is approximately 190 V for a 200 V class drives. The detection level is approximately 380 V for 400 V class drives. The detection level is approximately 350 V when <i>E1-01 [Input AC Supply Voltage] &lt; 400</i>.</li> <li>Do a Fault Reset to clear the fault.</li> <li>Fault trace is not available for this fault.</li> <li><i>L5-08 [Fault Reset Enable Select Grp2]</i> disables the Auto Restart function.</li> </ul>			
Code	Name	Causes	Possible Solutions
Uv2	Control Power Undervoltage	The value set in <i>L2-02 [Power Loss Ride Through Time]</i> increased and the momentary power loss recovery unit is not connected to the drive.	Connect the momentary power loss recovery unit to the drive.
		There was a problem with the drive hardware.	<ul style="list-style-type: none"> <li>Re-energize the drive.</li> <li>If the fault stays, replace the control board or the drive. For information about replacing the control board, contact Yaskawa or your nearest sales representative.</li> </ul>
<p><b>Note:</b></p> <ul style="list-style-type: none"> <li>The drive detects this error if the control power supply voltage decreases.</li> <li>Do a Fault Reset to clear the fault.</li> <li>Fault trace is not available for this fault.</li> </ul>			
Code	Name	Causes	Possible Solutions
Uv3	Soft Charge Answerback Fault	The relay or contactor on the soft-charge bypass relay is damaged.	<ul style="list-style-type: none"> <li>Re-energize the drive.</li> <li>If the fault stays, replace the control board or the drive.</li> <li>Check monitor <i>U4-06 [PreChargeRelayMainte]</i> shows the performance life of the soft-charge bypass relay. If <i>U4-06</i> is more than 90%, replace the board or the drive. For information about replacing the board, contact Yaskawa or your nearest sales representative.</li> </ul>
<p><b>Note:</b></p> <ul style="list-style-type: none"> <li>Do a Fault Reset to clear the fault.</li> <li>Fault trace is not available for this fault.</li> </ul>			



## 6.5 Minor Faults/Alarms

This section gives information about the causes and possible solutions when a minor fault or alarm occurs. Use the information in this table to remove the cause of the minor fault or alarm.

Code	Name	Causes	Possible Solutions
AEr	Station Address Setting Error	The node address for the option card is not in the permitted setting range.	<ul style="list-style-type: none"> <li>For CC-Link communication, set <i>F6-10 [CC-Link Node Address]</i> correctly.</li> <li>For MECHATROLINK communication, set <i>F6-20 [MECHATROLINK Station Address]</i> correctly.</li> <li>For CANopen communication, set <i>F6-35 [CANopen Node ID Selection]</i> correctly.</li> </ul>
<b>Note:</b> If the drive detects this error, the terminal assigned to <i>H2-01 to H2-03 = 10 [MFDO Function Select = Alarm]</i> will be ON.			
Code	Name	Causes	Possible Solutions
bAT	Keypad Battery Low Voltage	The keypad battery voltage is low.	Replace the keypad battery.
<b>Note:</b> <ul style="list-style-type: none"> <li>If detected, the terminal assigned to <i>H2-01 to H2-03 = 10 [MFDO Function Select = Alarm]</i> will switch ON.</li> <li>Set <i>o4-24 [bAT Detection Selection]</i> to enable/disable <i>bAT</i> detection.</li> </ul>			
Code	Name	Causes	Possible Solutions
bb	Baseblock	An external baseblock command was entered through MFDI terminal S1 to S8, and the drive output stopped as shown by an external baseblock command.	Examine the external sequence and timing of the baseblock command input.
<b>Note:</b> The drive will not output an alarm signal for this alarm.			
Code	Name	Causes	Possible Solutions
bCE	Bluetooth Communication Error	The smart device with DriveWizard Mobile is too far from the keypad.	Use the smart device within 10 m (32.8 ft.) from the keypad.  <b>Note:</b> <i>bCE</i> can occur when the smart device is 10 m or nearer to the keypad depending on the specifications of the smart device.
		Radio waves from a different device are causing interference with communications between the smart device and keypad.	Make sure that no device around the keypad uses the same radio bandwidth (2400 MHz to 2480 MHz), and prevent radio interference.
<b>Note:</b> <ul style="list-style-type: none"> <li>The drive detects this error when using the Bluetooth LCD keypad to operate the drive with a smart device.</li> <li>If the drive detects this error, the terminal assigned to <i>H2-01 to H2-03 = 10 [MFDO Function Select = Alarm]</i> will be ON.</li> <li>Use <i>o2-27 [bCE Detection selection]</i> to enable and disable <i>bCE</i> detection.</li> </ul>			
Code	Name	Causes	Possible Solutions
boL	Braking Transistor Overload	The duty cycle of the braking transistor is high (the regeneration power or repetition frequency is high).	<ul style="list-style-type: none"> <li>Install a braking unit (CDBR series).</li> <li>Install a regenerative converter.</li> <li>Increase the deceleration time.</li> </ul>
		You enabled the protective function for the braking transistor when you have a regenerative converter.	Set <i>L8-55 = 0 [Internal DB TransistorProtection = Disable]</i> .
		The braking transistor in the drive is broken.	Replace the drive.
<b>Note:</b> If the drive detects this error, the terminal assigned to <i>H2-01 to H2-03 = 10 [MFDO Function Select = Alarm]</i> will be ON.			
Code	Name	Causes	Possible Solutions
bUS	Option Communication Error	The communications cable wiring is incorrect.	Correct wiring errors.
		There is a short circuit or the communications cable is not connected.	<ul style="list-style-type: none"> <li>Repair short circuits and connect cables.</li> <li>Replace the defective communications cable.</li> </ul>

## 6.5 Minor Faults/Alarms

Code	Name	Causes	Possible Solutions
		Electrical interference caused a communication data error.	<ul style="list-style-type: none"> <li>Examine the control circuit lines, main circuit lines, and ground wiring, and decrease the effects of electrical interference.</li> <li>Make sure that a magnetic contactor is not the source of the electrical interference, then use a Surge Protective Device if necessary.</li> <li>Use only recommended cables or other shielded line. Ground the shield on the controller side or the drive input power side.</li> <li>Separate the communication wiring from drive power lines, and install a noise filter to the input side of the power supply for communication.</li> <li>Decrease the effects of electrical interference from the controller.</li> </ul>
		The option card is incorrectly installed to the drive.	Correctly install the option card to the drive.
		The option card is damaged.	If the fault continues and the wiring is correct, replace the option card.

**Note:**

- The drive detects this error if the Run command or frequency reference is assigned to the option card.
- If the drive detects this error, the terminal assigned to  $H2-01$  to  $H2-03 = 10$  [MFDO Function Select = Alarm] will be ON.
- If the drive detects this error, the drive will operate the motor as specified by the stopping method set in  $F6-01$  [Communication Error Selection].

Code	Name	Causes	Possible Solutions
CALL	Serial Comm Transmission Error	The communications cable wiring is incorrect.	Correct any wiring errors.
		There is a short circuit or the communications cable is not connected.	<ul style="list-style-type: none"> <li>Repair short circuits and connect cables.</li> <li>Replace the defective communications cable.</li> </ul>
		There was a programming error on the controller side.	Examine communications at start-up and correct programming errors.
		The communications circuitry is damaged.	<ul style="list-style-type: none"> <li>Do a self-diagnostics check.</li> <li>If the problem continues, replace the control board or the drive. For information about replacing the control board, contact Yaskawa or your nearest sales representative.</li> </ul>
		The termination resistor setting for MEMOBUS/Modbus communications is incorrect.	On the last drive in a MEMOBUS/Modbus network, set DIP switch S2 to the ON position to enable the termination resistor.

**Note:**

- The drive detects this error if it does not correctly receive control data from the controller when energizing the drive.
- If the drive detects this error, the terminal assigned to  $H2-01$  to  $H2-03 = 10$  [MFDO Function Select = Alarm] will be ON.

Code	Name	Causes	Possible Solutions
CE	Modbus Communication Error	The communications cable wiring is incorrect.	Correct wiring errors.
		There is a short circuit or the communications cable is not connected.	<ul style="list-style-type: none"> <li>Repair short circuits and connect cables.</li> <li>Replace the defective communications cable.</li> </ul>
		Electrical interference caused a communication data error.	<ul style="list-style-type: none"> <li>Examine the control circuit lines, main circuit lines, and ground wiring, and decrease the effects of electrical interference.</li> <li>Make sure that a magnetic contactor is not the source of the electrical interference, then use a Surge Protective Device if necessary.</li> <li>Use only recommended cables or other shielded line. Ground the shield on the controller side or the drive input power side.</li> <li>Separate the communication wiring from drive power lines, and install a noise filter to the input side of the power supply for communication.</li> <li>Decrease the effects of electrical interference from the controller.</li> </ul>

Code	Name	Causes	Possible Solutions
		The communication protocol is not compatible.	<ul style="list-style-type: none"> <li>Examine the values set in H5-xx.</li> <li>Examine the settings on the controller side and correct the difference in communication conditions.</li> </ul>
		The value set in H5-09 [CE Detection Time] is too small for the communications cycle.	<ul style="list-style-type: none"> <li>Change the controller software settings.</li> <li>Increase the value set in H5-09.</li> </ul>
		The controller software or hardware is causing a communication problem.	Examine the controller and remove the cause of the problem.
<b>Note:</b> <ul style="list-style-type: none"> <li>The drive detects this error if it does not correctly receive control data for the CE detection time set to H5-09.</li> <li>If the drive detects this error, the terminal assigned to H2-01 to H2-03 = 10 [MFDO Function Select = Alarm] will be ON.</li> <li>If the drive detects this error, the drive will operate the motor as specified by the stopping method set in H5-04 [Communication Error Stop Method].</li> </ul>			
Code	Name	Causes	Possible Solutions
CP1	Comparator 1 Limit Error	The monitor value set in H2-20 [Comparator 1 Monitor Selection] was in the range of H2-21 [Comparator 1 Lower Limit] and H2-22 [Comparator 1 Upper Limit].	Examine the monitor value and remove the cause of the error.
<b>Note:</b> <ul style="list-style-type: none"> <li>The drive detects this error when the terminal is assigned to H2-01 to H2-03 = 66 [MFDO Function Select = Comparator1].</li> <li>If the drive detects this error, the terminal assigned to H2-01 to H2-03 = 10 [MFDO Function Select = Alarm] will be ON.</li> <li>H2-33 [Comparator1 Protection Selection] enables and disables CP1 detection.</li> </ul>			
Code	Name	Causes	Possible Solutions
CP2	Comparator 2 Limit Error	The monitor value set in H2-26 [Comparator 2 Monitor Selection] was outside the range of H2-27 [Comparator 2 Lower Limit] and H2-28 [Comparator 2 Upper Limit].	Examine the monitor value and remove the cause of the error.
<b>Note:</b> <ul style="list-style-type: none"> <li>The drive detects this error when the terminal is assigned to H2-01 to H2-03 = 67 [MFDO Function Select = Comparator2].</li> <li>If the drive detects this error, the terminal assigned to H2-01 to H2-03 = 10 [MFDO Function Select = Alarm] will be ON.</li> <li>H2-35 [Comparator2 Protection Selection] enables and disables CP2 detection.</li> </ul>			
Code	Name	Causes	Possible Solutions
CrST	Cannot Reset	The drive received a fault reset command when a Run command was active.	Turn off the Run command then de-energize and re-energize the drive.
Code	Name	Causes	Possible Solutions
CyC	MECHATROLINK CommCycleSettingErr	The communications cycle of the controller is not set in the permitted range of the MECHATROLINK interface option card.	Set the communications cycle of the controller in the permitted range of the MECHATROLINK interface option card.
<b>Note:</b> If the drive detects this error, the terminal assigned to H2-01 to H2-03 = 10 [MFDO Function Select = Alarm] will be ON.			
Code	Name	Causes	Possible Solutions
dEv	Speed Deviation	The load is too heavy	Decrease the load.
		Acceleration and deceleration times are set too short.	Increase the values set in C1-01 to C1-08 [Acceleration/Deceleration Time].
		The dEv detection level settings are incorrect.	Adjust F1-10 [Speed Deviation Detection Level] and F1-11 [Speed Deviation Detect DelayTime].
		The load is locked up.	Examine the machine.
		The holding brake is stopping the motor.	Release the holding brake.
<b>Note:</b> <ul style="list-style-type: none"> <li>The drive detects this error if the difference between the detected speed and the speed reference is more than the setting of F1-10 for longer than F1-11.</li> <li>If the drive detects this error, the terminal assigned to H2-01 to H2-03 = 10 [MFDO Function Select = Alarm] will be ON.</li> <li>If the drive detects this error, the drive will operate the motor as specified by the stopping method set in F1-04 [Speed Deviation Detection Select].</li> </ul>			

## 6.5 Minor Faults/Alarms

Code	Name	Causes	Possible Solutions
dnE	Drive Disabled	A terminal set for $H1-xx = 6A$ [Drive Enable] turned OFF.	Examine the operation sequence.
<b>Note:</b> If the drive detects this error, the terminal assigned to $H2-01$ to $H2-03 = 10$ [MFDO Function Select = Alarm] will be ON.			
Code	Name	Causes	Possible Solutions
dWA2	DriveWorksEZ Alarm 2	There was an error in the DriveWorksEZ program.	Examine the DriveWorksEZ program and remove the cause of the error. This is not a drive fault.
<b>Note:</b> If the drive detects this error, the terminal assigned to $H2-01$ to $H2-03 = 10$ [MFDO Function Select = Alarm] will be ON.			
Code	Name	Causes	Possible Solutions
dWA3	DriveWorksEZ Alarm 3	There was an error in the DriveWorksEZ program.	Examine the DriveWorksEZ program and remove the cause of the error. This is not a drive fault.
<b>Note:</b> If the drive detects this error, the terminal assigned to $H2-01$ to $H2-03 = 10$ [MFDO Function Select = Alarm] will be ON.			
Code	Name	Causes	Possible Solutions
dWAL	DriveWorksEZ Alarm	There was an error in the DriveWorksEZ program.	Examine the DriveWorksEZ program and remove the cause of the error. This is not a drive fault.
<b>Note:</b> If the drive detects this error, the terminal assigned to $H2-01$ to $H2-03 = 10$ [MFDO Function Select = Alarm] will be ON.			
Code	Name	Causes	Possible Solutions
E5	MECHATROLINK Watchdog Timer Err	The drive detected a watchdog circuit exception while it received data from the controller.	Examine the MECHATROLINK cable connection. If this error occurs frequently, examine the wiring and decrease the effects of electrical interference as specified by these manuals: <ul style="list-style-type: none"> <li>MECHATROLINK-II Installation Guide (MECHATROLINK Members Association, manual number MMATDEP011)</li> <li>MECHATROLINK-III Installation Manual (MECHATROLINK Members Association, publication number MMATDEP018)</li> </ul>
<b>Note:</b> <ul style="list-style-type: none"> <li>If the drive detects this error, the terminal assigned to <math>H2-01</math> to <math>H2-03 = 10</math> [MFDO Function Select = Alarm] will be ON.</li> <li>If the drive detects this error, it will operate the motor as specified by the stop method set in <math>F6-25</math> [MECHATROLINK Watchdog Error Sel].</li> </ul>			
Code	Name	Causes	Possible Solutions
EF	FWD/REV Run Command Input Error	A forward command and a reverse command were input at the same time for longer than 0.5 s.	Examine the forward and reverse command sequence and correct the problem.
<b>Note:</b> <ul style="list-style-type: none"> <li>If the drive detects <math>EF</math>, the motor will ramp to stop.</li> <li>If the drive detects this error, the terminal assigned to <math>H2-01</math> to <math>H2-03 = 10</math> [MFDO Function Select = Alarm] will be ON.</li> </ul>			
Code	Name	Causes	Possible Solutions
EF0	Option Card External Fault	The communication option card received an external fault from the controller.	1. Find the device that caused the external fault and remove the cause. 2. Clear the external fault input from the controller.
		Programming error occurred on the controller side.	Examine the operation of the controller program.
<b>Note:</b> <ul style="list-style-type: none"> <li>The drive detects this error if the alarm function on the external device side is operating.</li> <li>If the drive detects this error, the terminal assigned to <math>H2-01</math> to <math>H2-03 = 10</math> [MFDO Function Select = Alarm] will be ON.</li> <li>Set the stopping method for this fault in <math>F6-03</math> [Comm External Fault (EF0) Select].</li> </ul>			
Code	Name	Causes	Possible Solutions
EF1	External Fault (Terminal S1)	MFDI terminal S1 caused an external fault through an external device.	1. Find the device that caused the external fault and remove the cause. 2. Clear the external fault input in the MFDI.
		The wiring is incorrect.	Correctly connect the signal line to MFDI terminal S1.

Code	Name	Causes	Possible Solutions
		<i>External Fault [H1-01 = 2C to 2F]</i> is set to MFDI terminal S1, but the terminal is not in use.	Correctly set the MFDI.
<b>Note:</b> If the drive detects this error, the terminal assigned to <i>H2-01 to H2-03 = 10 [MFDO Function Select = Alarm]</i> will be ON.			
Code	Name	Causes	Possible Solutions
EF2	External Fault (Terminal S2)	MFDI terminal S2 caused an external fault through an external device.	1. Find the device that caused the external fault and remove the cause. 2. Clear the external fault input in the MFDI.
		The wiring is incorrect.	Correctly connect the signal line to MFDI terminal S2.
		<i>External Fault [H1-02 = 2C to 2F]</i> is set to MFDI terminal S2, but the terminal is not in use.	Correctly set the MFDI.
<b>Note:</b> If the drive detects this error, the terminal assigned to <i>H2-01 to H2-03 = 10 [MFDO Function Select = Alarm]</i> will be ON.			
Code	Name	Causes	Possible Solutions
EF3	External Fault (Terminal S3)	MFDI terminal S3 caused an external fault through an external device.	1. Find the device that caused the external fault and remove the cause. 2. Clear the external fault input in the MFDI.
		The wiring is incorrect.	Correctly connect the signal line to MFDI terminal S3.
		<i>External Fault [H1-03 = 2C to 2F]</i> is set to MFDI terminal S3, but the terminal is not in use.	Correctly set the MFDI.
<b>Note:</b> If the drive detects this error, the terminal assigned to <i>H2-01 to H2-03 = 10 [MFDO Function Select = Alarm]</i> will be ON.			
Code	Name	Causes	Possible Solutions
EF4	External Fault (Terminal S4)	MFDI terminal S4 caused an external fault through an external device.	1. Find the device that caused the external fault and remove the cause. 2. Clear the external fault input in the MFDI.
		The wiring is incorrect.	Correctly connect the signal line to MFDI terminal S4.
		<i>External Fault [H1-04 = 2C to 2F]</i> is set to MFDI terminal S4, but the terminal is not in use.	Correctly set the MFDI.
<b>Note:</b> If the drive detects this error, the terminal assigned to <i>H2-01 to H2-03 = 10 [MFDO Function Select = Alarm]</i> will be ON.			
Code	Name	Causes	Possible Solutions
EF5	External Fault (Terminal S5)	MFDI terminal S5 caused an external fault through an external device.	1. Find the device that caused the external fault and remove the cause. 2. Clear the external fault input in the MFDI.
		The wiring is incorrect.	Correctly connect the signal line to MFDI terminal S5.
		<i>External Fault [H1-05 = 2C to 2F]</i> is set to MFDI terminal S5, but the terminal is not in use.	Correctly set the MFDI.
<b>Note:</b> If the drive detects this error, the terminal assigned to <i>H2-01 to H2-03 = 10 [MFDO Function Select = Alarm]</i> will be ON.			
Code	Name	Causes	Possible Solutions
EF6	External Fault (Terminal S6)	MFDI terminal S6 caused an external fault through an external device.	1. Find the device that caused the external fault and remove the cause. 2. Clear the external fault input in the MFDI.
		The wiring is incorrect.	Correctly connect the signal line to MFDI terminal S6.

## 6.5 Minor Faults/Alarms

Code	Name	Causes	Possible Solutions
		<i>External Fault [H1-06 = 2C to 2F]</i> is set to MFDI terminal S6, but the terminal is not in use.	Correctly set the MFDI.
<b>Note:</b> If the drive detects this error, the terminal assigned to <i>H2-01 to H2-03 = 10 [MFDO Function Select = Alarm]</i> will be ON.			
Code	Name	Causes	Possible Solutions
EF7	External Fault (Terminal S7)	MFDI terminal S7 caused an external fault through an external device.	1. Find the device that caused the external fault and remove the cause. 2. Clear the external fault input in the MFDI.
		The wiring is incorrect.	Correctly connect the signal line to MFDI terminal S7.
		<i>External Fault [H1-07 = 2C to 2F]</i> is set to MFDI terminal S7, but the terminal is not in use.	Correctly set the MFDI.
<b>Note:</b> If the drive detects this error, the terminal assigned to <i>H2-01 to H2-03 = 10 [MFDO Function Select = Alarm]</i> will be ON.			
Code	Name	Causes	Possible Solutions
EF8	External Fault (Terminal S8)	MFDI terminal S8 caused an external fault through an external device.	1. Find the device that caused the external fault and remove the cause. 2. Clear the external fault input in the MFDI.
		The wiring is incorrect.	Correctly connect the signal line to MFDI terminal S8.
		<i>External Fault [H1-08 = 2C to 2F]</i> is set to MFDI terminal S8, but the terminal is not in use.	Correctly set the MFDI.
<b>Note:</b> If the drive detects this error, the terminal assigned to <i>H2-01 to H2-03 = 10 [MFDO Function Select = Alarm]</i> will be ON.			
Code	Name	Causes	Possible Solutions
EP24v	External Power 24V Supply	The voltage of the main circuit power supply decreased, and the 24 V power supply is supplying power to the drive.	<ul style="list-style-type: none"> <li>Examine the main circuit power supply.</li> <li>Turn ON the main circuit power supply to run the drive.</li> </ul>
<b>Note:</b> <ul style="list-style-type: none"> <li>Set <i>o2-26 [Ext. Power 24V Supply Display]</i> to enable or disable <i>EP24v</i> detection.</li> <li>The drive will not output an alarm signal for this alarm.</li> </ul>			
Code	Name	Causes	Possible Solutions
FAn	Internal Fan Fault	The circulation fan stopped operating correctly.	<ul style="list-style-type: none"> <li>Examine circulation fan operation.</li> <li>Re-energize the drive.</li> <li>Check <i>U4-03 [Cooling Fan Ope Time]</i> and <i>U4-04 [Cool Fan Maintenance]</i>. If the performance life of the circulation fan is expired or if there is damage to the fan, replace the fan.</li> </ul>
		There is a problem with the power supply of the electromagnetic contactor and the circulation fan.	<ol style="list-style-type: none"> <li>Re-energize the drive.</li> <li>If the fault stays, replace the control board or the drive. For information about replacing the control board, contact Yaskawa or your nearest sales representative.</li> </ol>
<b>Note:</b> If the drive detects this error, the terminal assigned to <i>H2-01 to H2-03 = 10 [MFDO Function Select = Alarm]</i> will be ON.			
Code	Name	Causes	Possible Solutions
FbH	Excessive PID Feedback	The <i>FbH</i> detection level is set incorrectly.	Adjust <i>b5-36 [PID High Feedback Detection Lvl]</i> and <i>b5-37 [PID High Feedback Detection Time]</i> .
		There is a problem with the PID feedback wiring.	Correct errors with the PID control wiring.
		The feedback sensor is not operating correctly.	Examine the sensors on the control device side.

Code	Name	Causes	Possible Solutions
		A fault occurred in the feedback input circuit of the drive.	Replace the control board or the drive. For information about replacing the control board, contact Yaskawa or your nearest sales representative.
<b>Note:</b> <ul style="list-style-type: none"> <li>The drive detects this fault if the PID feedback input is more than the level set in <i>b5-36</i> for longer than <i>b5-37</i>.</li> <li>If detected, the terminal assigned to <i>H2-01 to H2-03 = 10 [MFDO Function Select = Alarm]</i> will be ON.</li> <li>If the drive detects this fault, it will operate the motor as specified by the stop method set in <i>b5-12 [Feedback Loss Detection Select]</i>.</li> </ul>			
Code	Name	Causes	Possible Solutions
FbL	PID Feedback Loss	The <i>FbL</i> detection level is set incorrectly.	Adjust <i>b5-13 [PID Feedback Loss Detection Lvl]</i> and <i>b5-14 [PID Feedback Loss Detection Time]</i> .
		There is a problem with the PID feedback wiring.	Correct errors with the PID control wiring.
		The feedback sensor is not operating correctly.	Examine the sensors on the control device side.
		A fault occurred in the feedback input circuit of the drive.	Replace the control board or the drive. For information about replacing the control board, contact Yaskawa or your nearest sales representative.
<b>Note:</b> <ul style="list-style-type: none"> <li>The drive detects this error if the PID feedback input is lower than the level set in <i>b5-13</i> for longer than <i>b5-14</i>.</li> <li>If the drive detects this error, the terminal assigned to <i>H2-01 to H2-03 = 10 [MFDO Function Select = Alarm]</i> will be ON.</li> <li>If the drive detects this error, it will operate the motor as specified by the stop method set in <i>b5-12 [Feedback Loss Detection Select]</i>.</li> </ul>			
Code	Name	Causes	Possible Solutions
HCA	High Current Alarm	The load is too heavy.	<ul style="list-style-type: none"> <li>Decrease the load for applications with repetitive starts and stops.</li> <li>Replace the drive with a larger capacity model.</li> </ul>
		The acceleration time is too short.	<ul style="list-style-type: none"> <li>Calculate the torque necessary during acceleration related to the load inertia and the specified acceleration time.</li> <li>Increase the values set in <i>C1-01, C1-03, C1-05, or C1-07 [Acceleration Times]</i> until you get the necessary torque.</li> <li>Increase the values set in <i>C2-01 to C2-04 [S-Curve Characteristics]</i> until you get the necessary torque.</li> <li>Replace the drive with a larger capacity model.</li> </ul>
		The drive is trying to operate a specialized motor or a motor that is larger than the maximum applicable motor output of the drive.	<ul style="list-style-type: none"> <li>Examine the motor nameplate, the motor, and the drive to make sure that the drive rated current is larger than the motor rated current.</li> <li>Replace the drive with a larger capacity model.</li> </ul>
		The current level temporarily increased because of speed search after a momentary power loss or while trying to Auto Restart.	If speed search or Auto Restart cause an increase in current, the drive can temporarily show this alarm. The time that the drive shows the alarm is short. No more steps are necessary to clear the alarm.
<b>Note:</b> <ul style="list-style-type: none"> <li>The drive detects this error if the drive output current is more than the overcurrent alarm level (150% of the rated current).</li> <li>If the drive detects this error, the terminal assigned to <i>H2-01 to H2-03 = 10 [MFDO Function Select = Alarm]</i> will be ON.</li> </ul>			
Code	Name	Causes	Possible Solutions
L24v	Loss of External Power 24 Supply	The voltage of the external 24 V power supply being used as a backup power supply has dropped. The main circuit power supply is in its normal state.	<ul style="list-style-type: none"> <li>Examine for wiring errors or disconnected wires in the external 24 V power supply, and repair problems.</li> <li>Examine for problems in the external 24 V power supply.</li> </ul>
<b>Note:</b> <ul style="list-style-type: none"> <li>Set <i>o2-23 [External 24V Powerloss Detection]</i> to enable or disable <i>L24v</i> detection.</li> <li>A minor fault signal will not be output even if the drive detects this alarm.</li> </ul>			

## 6.5 Minor Faults/Alarms

Code	Name	Causes	Possible Solutions
LoG	Com Error / Abnormal SD card	There is not a micro SD in the keypad.	Put a micro SD card in the keypad.
		<ul style="list-style-type: none"> <li>The drive is connected to USB.</li> <li>The number of log communication files is more than 1000.</li> <li>The micro SD card does not have available memory space.</li> <li>The line number data in a log communication file was changed.</li> <li>A communication error between the keypad and drive occurred during a log communication.</li> </ul>	Set $o5-01 = 0$ [ <i>Log Start/Stop Selection = OFF</i> ].
<b>Note:</b> If the drive detects this error, the terminal assigned to $H2-01$ to $H2-03 = 6A$ [ <i>MFDO Function Select = Data Logger Error</i> ] will be ON.			
Code	Name	Causes	Possible Solutions
LT-1	Cooling Fan Maintenance Time	The cooling fan is at 90% of its expected performance life.	<ol style="list-style-type: none"> <li>Use the procedures in this manual to replace the cooling fan.</li> <li>Set <math>o4-03 = 0</math> [<i>Fan Operation Time Setting = 0 h</i>] to reset the cooling fan operation time.</li> </ol>
<b>Note:</b> When the estimated performance life is expired, the terminal assigned to $H2-01$ to $H2-03 = 2F$ [ <i>MFDO Function Select = Maintenance Notification</i> ] will be ON.			
Code	Name	Causes	Possible Solutions
LT-2	Capacitor Maintenance Time	The capacitors for the main circuit and control circuit are at 90% of expected performance life.	Replace the control board or the drive. For information about replacing the control board, contact Yaskawa or your nearest sales representative.
<b>Note:</b> When the estimated performance life is expired, the terminal assigned to $H2-01$ to $H2-03 = 2F$ [ <i>MFDO Function Select = Maintenance Notification</i> ] will be ON.			
Code	Name	Causes	Possible Solutions
LT-3	SoftChargeBypassRelay MainteTime	The soft charge bypass relay is at 90% of its expected performance life.	Replace the control board or the drive. For information about replacing the control board, contact Yaskawa or your nearest sales representative.
<b>Note:</b> When the estimated performance life is expired, the terminal assigned to $H2-01$ to $H2-03 = 2F$ [ <i>MFDO Function Select = Maintenance Notification</i> ] will be ON.			
Code	Name	Causes	Possible Solutions
LT-4	IGBT Maintenance Time (50%)	The IGBT is at 50% of its expected performance life.	Check the load, carrier frequency, and output frequency.
<b>Note:</b> When the estimated performance life is expired, the terminal assigned to $H2-01$ to $H2-03 = 2F$ [ <i>MFDO Function Select = Maintenance Notification</i> ] will be ON.			
Code	Name	Causes	Possible Solutions
oH	Heatsink Overheat	The ambient temperature is high and the heatsink temperature is more than the $L8-02$ [ <i>Overheat Alarm Level</i> ].	<ul style="list-style-type: none"> <li>Measure the ambient temperature.</li> <li>Increase the airflow around the drive.</li> <li>Install a cooling device (cooling fan or air conditioner) to lower the ambient temperature.</li> <li>Remove objects near the drive that are producing too much heat.</li> </ul>
		There is not sufficient airflow around the drive.	<ul style="list-style-type: none"> <li>Give the drive the correct installation space as shown in the manual.</li> <li>Make sure that there is sufficient circulation around the control panel.</li> <li>Examine the drive for dust or other unwanted materials that could clog the cooling fan.</li> <li>Remove unwanted materials that prevent air circulation.</li> </ul>



Code	Name	Causes	Possible Solutions
		The internal cooling fan or fans have stopped.	<ol style="list-style-type: none"> <li>Use the procedures in this manual to replace the cooling fan.</li> <li>Set <math>o4-03 = 0</math> [<i>Fan Operation Time Setting = 0 h</i>] to reset the cooling fan operation time.</li> </ol>
<p><b>Note:</b></p> <ul style="list-style-type: none"> <li>The drive detects this error if the heatsink temperature of the drive is more than <math>L8-02</math>.</li> <li>If the drive detects this error, the terminal assigned to <math>H2-01</math> to <math>H2-03 = 10</math> [<i>MFDO Function Select = Alarm</i>] will be ON.</li> <li>Set the stopping method for this fault in <math>L8-03</math> [<i>Overheat Pre-Alarm Selection</i>].</li> </ul>			
Code	Name	Causes	Possible Solutions
oH2	External Overheat (H1-XX=B)	An external device sent an oH2.	<ol style="list-style-type: none"> <li>Find the external device that output the overheat alarm.</li> <li>Remove the cause of the problem.</li> <li>Clear the <i>Overheat Alarm (oH2)</i> [<math>H1-xx = B</math>] that was set to MFDI terminals S1 to S8.</li> </ol>
<p><b>Note:</b></p> <p>If the drive detects this error, the terminal assigned to <math>H2-01</math> to <math>H2-03 = 10</math> [<i>MFDO Function Select = Alarm</i>] will be ON.</p>			
Code	Name	Causes	Possible Solutions
oH3	Motor Overheat (PTC Input)	The thermistor wiring that detects motor temperature is defective.	Correct any wiring errors.
		A fault occurred on the machine side. Example: The machine is locked.	Examine the machine and remove the cause of the fault.
		The motor has overheated.	<ul style="list-style-type: none"> <li>Check the load level, acceleration/deceleration time, and motor start/stop frequency (cycle time).</li> <li>Decrease the load.</li> <li>Increase the values set in <math>C1-01</math> to <math>C1-08</math> [<i>Acceleration/Deceleration Time</i>].</li> <li>Set <math>E2-01</math> [<i>Motor Rated Current (FLA)</i>] correctly to the value specified by the motor nameplate.</li> <li>Make sure that the motor cooling system is operating correctly, and repair or replace it if it is damaged.</li> <li>Adjust <math>E1-04</math> to <math>E1-10</math> [<i>V/f Pattern Parameters</i>]. For motor 2, adjust <math>E3-04</math> to <math>E3-10</math>. Decrease the values set in <math>E1-08</math> [<i>Mid Point A Voltage</i>] and <math>E1-10</math> [<i>Minimum Output Voltage</i>].</li> </ul> <p><b>Note:</b></p> <p>If <math>E1-08</math> and <math>E1-10</math> are set too low, the overload tolerance will decrease at low speeds.</p>
<p><b>Note:</b></p> <ul style="list-style-type: none"> <li>The drive detects this error if the motor overheat signal that was entered to an analog input terminals A1, A2, or A3 is more than the alarm detection level. (If <math>H3-02</math>, <math>H3-10</math>, or <math>H3-06 = E</math> [<i>MFAI Function Select = Motor Temperature (PTC Input)</i>] was set.)</li> <li>If the drive detects this error, the terminal assigned to <math>H2-01</math> to <math>H2-03 = 10</math> [<i>MFDO Function Select = Alarm</i>] will be ON.</li> <li>If the drive detects this fault, it will operate the motor as specified by the Stopping Method set in <math>L1-03</math> [<i>Motor Thermistor oH Alarm Select</i>].</li> </ul>			
Code	Name	Causes	Possible Solutions
oL3	Overtorque 1	A fault occurred on the machine. Example: The machine is locked.	Examine the machine and remove the cause of the fault.
		The parameters are incorrect for the load.	Adjust $L6-02$ [ <i>Torque Detection Level 1</i> ] and $L6-03$ [ <i>Torque Detection Time 1</i> ] settings.
<p><b>Note:</b></p> <ul style="list-style-type: none"> <li>The drive detects this fault if the drive output current is more than the level set in <math>L6-02</math> for longer than <math>L6-03</math>.</li> <li>If the drive detects this error, the terminal assigned to <math>H2-01</math> to <math>H2-03 = 10</math> [<i>MFDO Function Select = Alarm</i>] will be ON.</li> <li>Set the conditions that trigger the minor fault using <math>L6-01</math> [<i>Torque Detection Selection 1</i>].</li> </ul>			

## 6.5 Minor Faults/Alarms

Code	Name	Causes	Possible Solutions
oL4	Overtorque 2	A fault occurred on the machine. Example: The machine is locked.	Examine the machine and remove the cause of the fault.
		The parameters are incorrect for the load.	Adjust L6-05 [Torque Detection Level 2] and L6-06 [Torque Detection Time 2] settings.
<b>Note:</b> <ul style="list-style-type: none"> <li>The drive detects this error if the drive output current is more than the level set in L6-05 for longer than L6-06.</li> <li>If the drive detects this error, the terminal assigned to H2-01 to H2-03 = 10 [MFDO Function Select = Alarm] will be ON.</li> <li>Set the conditions that trigger the minor fault using L6-04 [Torque Detection Selection 2].</li> </ul>			
Code	Name	Causes	Possible Solutions
oL5	Mechanical Weakening Detection 1	The drive detected overtorque as specified by the conditions for mechanical weakening detection set in L6-08 [Mechanical Fatigue Detect Select].	Do a deterioration diagnostic test on the machine side.
<b>Note:</b> <ul style="list-style-type: none"> <li>If the drive detects this error, the terminal assigned to H2-01 to H2-03 = 10 [MFDO Function Select = Alarm] will be ON.</li> <li>If the drive detects this minor fault, it will operate the motor as specified by the Stopping Method set in L6-08.</li> </ul>			
Code	Name	Causes	Possible Solutions
oS	Overspeed	There is overshoot.	<ul style="list-style-type: none"> <li>Decrease C5-01 [ASR Proportional Gain 1] and increase C5-02 [ASR Integral Time 1].</li> <li>Adjust the pulse train gain with H6-02 to H6-05 [Pulse Train Input Setting Parameters].</li> </ul>
		There are an incorrect number of PG pulses set in the drive.	Set H6-02 [Terminal RP Frequency Scaling] to the pulse train frequency during 100% reference (maximum motor rotation speed).
		The oS detection level is set incorrectly.	Adjust F1-08 [Overspeed Detection Level] and F1-09 [Overspeed Detection Delay Time].
<b>Note:</b> <ul style="list-style-type: none"> <li>The drive detects this error if the motor speed is more than the value set in F1-08 for longer than F1-09.</li> <li>If the drive detects this error, the terminal assigned to H2-01 to H2-03 = 10 [MFDO Function Select = Alarm] will be ON.</li> <li>If the drive detects this error, it will operate the motor as specified by the Stopping Method set in F1-03 [Overspeed Detection Selection].</li> </ul>			
Code	Name	Causes	Possible Solutions
ov	DC Bus Overvoltage	There are surge voltages in the input power supply.	Connect a DC reactor to the drive.  <b>Note:</b> If you turn the phase advancing capacitors ON and OFF and use thyristor converters in the same power supply system, there can be surge voltages that irregularly increase the input voltage.
		The drive output cable or motor is shorted to ground (the current short to ground is charging the main circuit capacitor of the drive through the power supply).	<ol style="list-style-type: none"> <li>Examine the motor main circuit cable, terminals, and motor terminal box, and then remove ground faults.</li> <li>Re-energize the drive.</li> </ol>
		The power supply voltage is too high.	Decrease the power supply voltage to match the drive rated voltage.
		Electrical interference caused a drive malfunction.	<ul style="list-style-type: none"> <li>Examine the control circuit lines, main circuit lines, and ground wiring, and decrease the effects of electrical interference.</li> <li>Check whether a magnetic contactor is the noise source, and use Surge Protective Device if necessary.</li> <li>Set L5-01 <math>\neq 0</math> [Number of Auto-Restart Attempts <math>\neq 0</math> times].</li> </ul>
<b>Note:</b> <ul style="list-style-type: none"> <li>The drive detects this error if the DC bus voltage is more than the ov detection level when the Run command has not been input (while the drive is stopped).</li> <li>The ov detection level is approximately 410 V with 200 V class drives. The detection level is approximately 820 V with 400 V class drives.</li> <li>If the drive detects this error, the terminal assigned to H2-01 to H2-03 = 10 [MFDO Function Select = Alarm] will be ON.</li> </ul>			

Code	Name	Causes	Possible Solutions
PASS	Modbus Communication Test	The MEMOBUS/Modbus communications test is complete.	The <i>PASS</i> display will turn off after communications test mode is cleared.
Code	Name	Causes	Possible Solutions
PF	Input Phase Loss	There is a phase loss in the drive input power.	Correct errors with the wiring for main circuit drive input power.
		Loose wiring in the input power terminals.	Tighten the terminal screws to the correct tightening torque.
		The drive input power voltage is changing too much.	<ul style="list-style-type: none"> <li>Examine the input power for problems.</li> <li>Make the drive input power stable.</li> </ul>
		Unsatisfactory balance between voltage phases.	<ul style="list-style-type: none"> <li>Examine the input power for problems.</li> <li>Make the drive input power stable.</li> <li>If the input power supply is good, examine the magnetic contactor on the main circuit side for problems.</li> </ul>
		The main circuit capacitors have become unserviceable.	<ul style="list-style-type: none"> <li>Examine the capacitor maintenance time in monitor <i>U4-05 [Capacitor Maintenance]</i>.</li> <li>If <i>U4-05</i> is more than 90%, replace the capacitor. Contact Yaskawa or your nearest sales representative for more information.</li> </ul>
<p><b>Note:</b></p> <ul style="list-style-type: none"> <li>The drive detects this error if the DC bus voltage changes irregularly without regeneration.</li> <li>If the drive detects this error, the terminal assigned to <i>H2-01 to H2-03 = 10 [MFDO Function Select = Alarm]</i> will be ON.</li> <li>Use <i>L8-05 [Input Phase Loss Protection Sel]</i> to enable and disable PF detection.</li> </ul>			
Code	Name	Causes	Possible Solutions
PGo	Encoder (PG) Feedback Loss	The encoder cable is disconnected or wired incorrectly.	Examine for wiring errors or disconnected wires in the encoder cable, and repair problems.
		The encoder is not receiving power.	Examine the encoder power supply.
		The holding brake is stopping the motor.	Release the holding brake.
<p><b>Note:</b></p> <ul style="list-style-type: none"> <li>The drive detects this error if it does not receive the speed detection pulse signal from the encoder in the detection time set in <i>F1-14 [Encoder Open-Circuit Detect Time]</i>.</li> <li>If the drive detects this error, the terminal assigned to <i>H2-01 to H2-03 = 10 [MFDO Function Select = Alarm]</i> will be ON.</li> <li>If the drive detects this error, it will operate the motor as specified by the Stopping Method set in <i>F1-02 [PG Open Circuit Detection Select]</i>.</li> </ul>			
Code	Name	Causes	Possible Solutions
PGoH	Encoder (PG) Hardware Fault	The encoder cable is disconnected.	Correct any disconnected wires in the encoder cable.
<p><b>Note:</b></p> <ul style="list-style-type: none"> <li>If the drive detects this error, the terminal assigned to <i>H2-01 to H2-03 = 10 [MFDO Function Select = Alarm]</i> will be ON.</li> <li>If the drive detects this error, it will operate the motor as specified by the Stopping Method set in <i>F1-02 [PG Open Circuit Detection Select]</i>.</li> </ul>			
Code	Name	Causes	Possible Solutions
rUn	Motor Switch during Run	The drive received a <i>Motor 2 Selection [H1-xx = 16]</i> during run.	Make sure that the drive receives the Motor 2 Selection while the drive is stopped.
<p><b>Note:</b></p> <p>If the drive detects this error, the terminal assigned to <i>H2-01 to H2-03 = 10 [MFDO Function Select = Alarm]</i> will be ON.</p>			
Code	Name	Causes	Possible Solutions
SE	Modbus Test Mode Error	MEMOBUS/Modbus communications self-diagnostics [ <i>H1-xx = 67</i> ] was done while the drive was running.	Stop the drive and do MEMOBUS/Modbus communications self-diagnostics.
<p><b>Note:</b></p> <p>If detected, the terminal assigned to <i>H2-01 to H2-03 = 10 [MFDO Function Select = Alarm]</i> will be ON.</p>			


## 6.5 Minor Faults/Alarms

Code	Name	Causes	Possible Solutions
STo	Safe Torque OFF	Safe Disable inputs H1-HC and H2-HC are open.	<ul style="list-style-type: none"> <li>Make sure that the Safe Disable signal is input from an external source to terminal H1-HC and H2-HC.</li> <li>When the Safe Disable function is not in use, connect terminals H1-HC and H2-HC.</li> </ul>
		There is internal damage to the two Safe Disable channels.	Replace the control board or the drive. For information about replacing the control board, contact Yaskawa or your nearest sales representative.
<b>Note:</b> If the drive detects this error, the terminal assigned to $H2-01$ to $H2-03 = 10$ [MFDO Function Select = Alarm] will be ON.			
Code	Name	Causes	Possible Solutions
SToF	Safe Torque OFF Hardware	One of the two terminals H1-HC or H2-HC received the Safe Disable input signal.	<ul style="list-style-type: none"> <li>Make sure that the Safe Disable signal is input from an external source to terminal H1-HC and H2-HC.</li> <li>When the Safe Disable function is not in use, connect terminals H1-HC and H2-HC.</li> </ul>
		The Safe Disable input signal is wired incorrectly.	
		There is internal damage to one Safe Disable channel.	Replace the control board or the drive. For information about replacing the control board, contact Yaskawa or your nearest sales representative.
<b>Note:</b> If the drive detects this error, the terminal assigned to $H2-01$ to $H2-03 = 10$ [MFDO Function Select = Alarm] will be ON.			
Code	Name	Causes	Possible Solutions
TiM	Keypad Time Not Set	There is a battery in the keypad, but the date and time are not set.	Set the date and time with the keypad.
<b>Note:</b> <ul style="list-style-type: none"> <li><math>o4-24</math> [bAT Detection selection] enables and disables <i>TiM</i> detection.</li> <li>If the drive detects this error, the terminal assigned to <math>H2-01</math> to <math>H2-03 = 10</math> [MFDO Function Select = Alarm] will be ON.</li> </ul>			
Code	Name	Causes	Possible Solutions
TrPC	IGBT Maintenance Time (90%)	The IGBT is at 90% of its expected performance life.	Replace the IGBT or the drive. For information about replacing the control board, contact Yaskawa or your nearest sales representative.
<b>Note:</b> If the drive detects this error, the terminal assigned to $H2-01$ to $H2-03 = 10$ [MFDO Function Select = Alarm] will be ON.			
Code	Name	Causes	Possible Solutions
UL3	Undertorque Detection 1	A fault occurred on the machine. Example: There is a broken pulley belt.	Examine the machine and remove the cause of the fault.
		The parameters are incorrect for the load.	Adjust $L6-02$ [Torque Detection Level 1] and $L6-03$ [Torque Detection Time 1] settings.
<b>Note:</b> <ul style="list-style-type: none"> <li>The drive detects this error if the drive output current is less than the level set in <math>L6-02</math> for longer than <math>L6-03</math>.</li> <li>If the drive detects this error, the terminal assigned to <math>H2-01</math> to <math>H2-03 = 10</math> [MFDO Function Select = Alarm] will be ON.</li> <li>If the drive detects this error, it will operate the motor as specified by the Stopping Method set in <math>L6-01</math> [Torque Detection Selection 1].</li> </ul>			
Code	Name	Causes	Possible Solutions
UL4	Undertorque Detection 2	A fault occurred on the machine. Example: There is a broken pulley belt.	Examine the machine and remove the cause of the fault.
		The parameters are incorrect for the load.	Adjust $L6-05$ [Torque Detection Level 2] and $L6-06$ [Torque Detection Time 2] settings.
<b>Note:</b> <ul style="list-style-type: none"> <li>The drive detects this error if the drive output current is less than the level set in <math>L6-05</math> for longer than <math>L6-06</math>.</li> <li>If detected, the terminal assigned to <math>H2-01</math> to <math>H2-03 = 10</math> [MFDO Function Select = Alarm] will be ON.</li> <li>If the drive detects this error, it will operate the motor as specified by the Stopping Method set in <math>L6-04</math> [Torque Detection Selection 2].</li> </ul>			

Code	Name	Causes	Possible Solutions
UL5	Mechanical Weakening Detection 2	The drive detected undertorque as specified by the conditions for mechanical weakening detection set in L6-08 [Mechanical Fatigue Detect Select].	Examine the machine for deterioration.
<b>Note:</b> <ul style="list-style-type: none"> <li>• If the drive detects this error, the terminal assigned to H2-01 to H2-03 = 10 [MFDO Function Select = Alarm] will be ON.</li> <li>• If the drive detects this error, it will operate the motor as specified by the Stopping Method set in L6-08.</li> </ul>			
Code	Name	Causes	Possible Solutions
Uv	Undervoltage	The drive input power voltage is changing too much.	<ul style="list-style-type: none"> <li>• Examine the input power for problems.</li> <li>• Make the drive input power stable.</li> <li>• If the input power supply is good, examine the magnetic contactor on the main circuit side for problems.</li> </ul>
		There is a phase loss in the drive input power.	Correct errors with the wiring for main circuit drive input power.
		There is loose wiring in the drive input power terminals.	Tighten the terminal screws to the correct tightening torque.
		There was a loss of power.	Use a better power supply.
		The main circuit capacitors have become unserviceable.	Examine the capacitor maintenance time in monitor U4-05 [Capacitor Maintenance]. If U4-05 is more than 90%, replace the control board or the drive. For information about replacing the control board, contact Yaskawa or your nearest sales representative.
		The drive input power transformer is too small and voltage drops when the power is switched on.	<ul style="list-style-type: none"> <li>• Check for an alarm when a molded-case circuit breaker, Leakage Breaker (ELCB, GFCI, or RCM/RCD) (with overcurrent protective function), or magnetic contactor is ON.</li> <li>• Check the capacity of the drive power supply transformer.</li> </ul>
		Air inside the drive is too hot.	Check the ambient temperature of the drive.
		The Charge LED is broken.	Replace the control board or the entire drive. For information about replacing the control board, contact Yaskawa or your nearest sales representative.
<b>Note:</b> <ul style="list-style-type: none"> <li>• The drive detects this error if one of these conditions is correct when the Run command has not been input (while the drive is stopped). <ul style="list-style-type: none"> <li>–The DC bus voltage &lt; L2-05 [Undervoltage Detection Lvl (Uv1)].</li> <li>–The Contactor that prevents inrush current in the drive was opened.</li> <li>–There is low voltage in the control drive input power.</li> </ul> </li> <li>• If the drive detects this error, the terminal assigned to H2-01 to H2-03 = 10 [MFDO Function Select = Alarm] will be ON.</li> </ul>			

## 6.6 Parameter Setting Errors

Parameter setting errors occur when multiple parameter settings do not agree, or when parameter setting values are not correct. Refer to the table in this section, examine the parameter setting that caused the error, and remove the cause of the error. You must first correct the parameter setting errors before you can operate the drive. The drive will not send notification signals for the faults and alarms when these parameter setting errors occur.


Code	Name	Causes	Possible Solutions
oPE01	Drive Capacity Setting Error	The value set in <i>o2-04 [Drive Model (KVA) Selection]</i> does not agree with the drive model.	Set <i>o2-04</i> to the correct value.
Code	Name	Causes	Possible Solutions
oPE02	Parameter Range Setting Error	Parameters settings are not in the applicable setting range.	<ol style="list-style-type: none"> <li>1. Push  to show <i>U1-18 [oPE Fault Parameter]</i>, and find parameters that are not in the applicable setting range.</li> <li>2. Correct the parameter settings.</li> </ol> <p><b>Note:</b> If more than one error occurs at the same time, other <i>oPExx</i> errors have priority over <i>oPE02</i>.</p>
		Set <i>E2-01 ≤ E2-03 [Motor Rated Current (FLA) ≤ Motor No-Load Current]</i> .	<p>Make sure that <i>E2-01 &gt; E2-03</i>.</p> <p><b>Note:</b> If it is necessary to set <i>E2-01 &lt; E2-03</i>, first lower the value set in <i>E2-03</i>, and then set <i>E2-01</i>.</p>
Code	Name	Causes	Possible Solutions
oPE03	Multi-Function Input Setting Err	The settings for these parameters do not agree: <ul style="list-style-type: none"> <li>• <i>H1-01 to H1-08 [Terminal S1 to S8 Function Selection]</i></li> <li>• <i>F3-10 to F3-25 [Terminal D1 to DF Function Selection]</i></li> <li>• <i>H7-01 to H7-04 [Virtual Multi-Function Inputs 1 to 4]</i></li> </ul>	Set the parameters correctly.
		The settings for the standby mode function do not agree: <ul style="list-style-type: none"> <li>• <i>b8-50 = 0 [Standby Mode Selection = Disabled]</i> and <i>H2-xx = 65 [MFDO Function Select = Standby Output]</i></li> <li>• <i>b8-50 = 1 [Enabled]</i> and <i>H2-xx ≠ 65</i></li> </ul>	Set the parameters correctly.
		The settings for MFDI overlap. <p><b>Note:</b> This does not include <i>H1-xx = 20 to 2F [MFDI Function Select = External Fault]</i> and <i>[Reserved]</i>.</p>	Set the parameters correctly to prevent MFDI function overlap.
		These pairs of MFDI functions are not set to Digital Inputs ( <i>H1-xx</i> , <i>F3-10 to F3-25</i> , and <i>H7-01 to H7-04</i> ) at the same time: <ul style="list-style-type: none"> <li>• Setting values <i>10 [Up Command]</i> and <i>11 [Down Command]</i></li> <li>• Setting values <i>75 [Up 2 Command]</i> and <i>76 [Down 2 Command]</i></li> <li>• Setting values <i>42 [Run Command (2-Wire Sequence 2)]</i> and <i>43 [FWD/REV (2-Wire Sequence 2)]</i></li> </ul>	Set the MFDI pairs.

Code	Name	Causes	Possible Solutions
		<p>A minimum of two of these MFDI combinations are set to Digital Inputs (<i>H1-xx</i>, <i>F3-10</i> to <i>F3-25</i>, and <i>H7-01</i> to <i>H7-04</i>) at the same time:</p> <ul style="list-style-type: none"> <li>Setting values 10 [<i>Up Command</i>] and 11 [<i>Down Command</i>]</li> <li>Setting values 75 [<i>Up 2 Command</i>] and 76 [<i>Down 2 Command</i>]</li> <li>Setting values <i>A</i> [<i>Accel/Decel Ramp Hold</i>]</li> <li>Setting values 1E [<i>Reference Sample Hold</i>]</li> <li>Setting values 44 to 46 [<i>Add Offset Frequency 1 to 3 (d7-01 to d7-03)</i>]</li> </ul>	Remove the function settings that are not in use.
		<p>These PID settings are enabled at the same time.</p> <ul style="list-style-type: none"> <li><i>b5-01</i> [<i>PID Mode Setting</i>]</li> <li><i>H1-xx</i> = 10 [<i>Up Command</i>]</li> <li><i>H1-xx</i> = 11 [<i>Down Command</i>]</li> </ul>	<ul style="list-style-type: none"> <li>Set <i>b5-01</i> = 0 [<i>Disabled</i>].</li> <li>Remove the function Up/Down command settings.</li> </ul>
		<p>These commands are set in Digital Inputs (<i>H1-xx</i>, <i>F3-10</i> to <i>F3-25</i>, and <i>H7-01</i> to <i>H7-04</i>) at the same time:</p> <ul style="list-style-type: none"> <li>Setting values 61 [<i>Speed Search from Fmax</i>] and 62 [<i>Speed Search from Fref</i>]</li> <li>Setting values 65, 66, 7A, 7B [<i>KEB Ride-Thru 1 or 2 Activate</i>] and 68 [<i>High Slip Braking (HSB) Activate</i>]</li> <li>Setting values 16 [<i>Motor 2 Selection</i>] and 1A [<i>Accel/Decel Time Selection 2</i>]</li> <li>Setting values 65, 66 [<i>KEB Ride-Thru 1 Activate</i>] and 7A, 7B [<i>KEB Ride-Thru 2 Activate</i>]</li> <li>Setting values 40, 41 [<i>Forward RUN (2-Wire)</i>, <i>Reverse RUN (2-Wire)</i>] and 42, 43 [<i>Run Command (2-Wire Sequence 2)</i>, <i>FWD/REV (2-Wire Sequence 2)</i>]</li> <li>Setting values 60 [<i>DC Injection Braking Command</i>] and 6A [<i>Drive Enable</i>]</li> <li>Setting values 16 [<i>Motor 2 Selection</i>] and 75, 76 [<i>Up 2 Command, Down 2 Command</i>]</li> </ul>	Remove the function settings that are not in use.
		<p>Settings for N.C. and N.O. input [<i>H1-xx</i>] for these functions were selected at the same time:</p> <ul style="list-style-type: none"> <li>Setting value 15 [<i>Fast Stop (N.O.)</i>]</li> <li>Setting value 17 [<i>Fast Stop (N.C.)</i>]</li> </ul>	Remove one of the function settings.
		<p>These settings were entered while <i>H1-xx</i> = 2 [<i>External Reference 1/2 Selection</i>]:</p> <ul style="list-style-type: none"> <li><i>b1-15</i> = 4 [<i>Frequency Reference Selection 2 = Pulse Train Input</i>]</li> <li><i>H6-01</i> ≠ 0 [<i>Terminal RP Pulse Train Function ≠ Frequency Reference</i>]</li> </ul>	Set <i>H6-01</i> = 0
		<p>These settings were entered while <i>H1-xx</i> = 2 [<i>External Reference 1/2 Selection</i>]:</p> <ul style="list-style-type: none"> <li><i>b1-15</i> = 3 [<i>Option PCB</i>] or <i>b1-16</i> = 3 [<i>Run Command Selection 2 = Option PCB</i>]</li> <li>No option card is connected to the drive.</li> </ul>	Connect an input option card to the drive.

## 6.6 Parameter Setting Errors

Code	Name	Causes	Possible Solutions
		<p>These settings were entered while <math>H1-xx = 2</math> [External Reference 1/2 Selection]:</p> <ul style="list-style-type: none"> <li>• <math>b1-15 = 1</math> [Analog Input]</li> <li>• <math>H3-02 \neq 0</math> [Terminal A1 Function Selection <math>\neq</math> Frequency Reference] or <math>H3-10 \neq 0</math> [Terminal A2 Function Selection <math>\neq</math> Frequency Reference]</li> </ul>	Set $H3-02 = 0$ or $H3-10 = 0$ .
		<p>These parameters are set at the same time:</p> <ul style="list-style-type: none"> <li>• <math>H1-xx \neq 6A</math> [Drive Enable]</li> <li>• <math>H2-xx = 38</math> [Drive Enabled]</li> </ul>	Set the parameters correctly.
		<p>These parameters are set at the same time:</p> <ul style="list-style-type: none"> <li>• <math>H6-01 \neq 3</math> [PG Speed Feedback (V/F Control)]</li> <li>• <math>H1-xx = 7E</math> [Reverse Rotation Identifier]</li> </ul>	Set the parameters correctly.
		<p>The following parameters are set at the same time:</p> <ul style="list-style-type: none"> <li>• <math>H1-xx = 75/76</math> [Up 2 /Down 2 Command]</li> <li>• <math>H3-01, H3-05, H3-09 = 1</math> [Terminal A1, A2, A3 Signal Level Select = -10 to +10V (Bipolar Reference)]</li> </ul>	Remove one of the function settings.
		<p>These settings do not agree:</p> <ul style="list-style-type: none"> <li>• A PG-RT3 option is connected to the drive.</li> <li>• <math>H1-xx = 16</math> [Motor 2 Selection] is set.</li> </ul>	<p>Set the parameter correctly.</p> <p><b>Note:</b> The Motor Switch function is not available with the PG-RT3 option.</p>
Code	Name	Causes	Possible Solutions
oPE05	Run Cmd/Freq Ref Source Sel Err	The setting to assign the Run command or frequency reference to an option card or the pulse train input is incorrect.	Correct the parameter settings.
		$b1-01 = 3$ [Frequency Reference Selection 1 = Option PCB] is set, but there is no option card connected to the drive.	Connect an option card to the drive.
		$b1-02 = 3$ [Run Command Selection 1 = Option PCB] is set, but there is no option card connected to the drive.	
		The following parameters are set at the same time:	Set $H6-01 = 0$ .
		The following parameters are set at the same time:	Set $F3-03 = 2$ [16-bit].
		These parameters are set and there is an AI-A3 option card connected to the drive:	Correct the parameter settings.
		<ul style="list-style-type: none"> <li>• <math>H1-xx = 2</math> [External Reference 1/2 Selection]</li> <li>• <math>b1-15 = 3</math> [Frequency Reference Selection 2 = Option PCB]</li> <li>• <math>F2-01 = 0</math> [Analog Input Function Selection = 3 Independent Channels]</li> </ul>	



Code	Name	Causes	Possible Solutions
oPE06	Control Method Selection Error	$A1-02 = 1, 3, \text{ or } 7$ [Control Method Selection = CL-V/f, CLV, CLV/PM] is set, but there is no encoder option card connected to the drive.	<ul style="list-style-type: none"> <li>Connect an encoder option card to the drive.</li> <li>Set <math>A1-02</math> correctly.</li> </ul>
Code	Name	Causes	Possible Solutions
oPE07	Analog Input Selection Error	The settings for $H3-02, H3-06, \text{ and } H3-10$ [MFAI Function Select] and $H7-30$ [Virtual Analog Input Selection] overlap.	Set $H3-02, H3-06, H3-10, \text{ and } H7-30$ correctly to prevent overlap. <b>Note:</b> It is possible to set these functions to multiple analog input terminals at the same time: <ul style="list-style-type: none"> <li>Setting value 0 [Frequency Reference]</li> <li>Setting values <math>F</math> and <math>1F</math> [Not Used]</li> </ul>
		The following parameters are set at the same time: <ul style="list-style-type: none"> <li><math>H3-02, H3-06, H3-10, H7-30 = B</math> [PID Feedback]</li> <li><math>H6-01 = 1</math> [Terminal RP Pulse Train Function = PID Feedback Value]</li> </ul>	Remove the function settings that are not in use.
		The following parameters are set at the same time: <ul style="list-style-type: none"> <li><math>H3-02, H3-06, H3-10, H7-30 = C</math> [PID Setpoint]</li> <li><math>H6-01 = 2</math> [PID Setpoint Value]</li> </ul>	
		The following parameters are set at the same time: <ul style="list-style-type: none"> <li><math>H3-02, H3-06, H3-10, H7-30 = C</math></li> <li><math>b5-18 = 1</math> [<math>b5-19</math> PID Setpoint Selection = Enabled]</li> </ul>	
		The following parameters are set at the same time: <ul style="list-style-type: none"> <li><math>H6-01 = 2</math></li> <li><math>b5-18 = 1</math></li> </ul>	
Code	Name	Causes	Possible Solutions
oPE08	Parameter Selection Error	A function was set that is not compatible with the control method selected in $A1-02$ [Control Method Selection].	<ol style="list-style-type: none"> <li>Push  to show <math>U1-18</math> [oPE Fault Parameter], and find parameters that are not in the applicable setting range.</li> <li>Correct the parameter settings.</li> </ol> <b>Note:</b> If more than one error occurs at the same time, other $oPE_{xx}$ errors have priority over $oPE02$ .
		These parameters were set in OLV Control: <ul style="list-style-type: none"> <li><math>n2-02 &gt; n2-03</math> [Automatic Freq Regulator Time 1 &gt; Automatic Freq Regulator Time 2]</li> <li><math>C4-02 &gt; C4-06</math> [Torque Compensation Delay Time &gt; Motor 2 Torque Comp Delay Time]</li> </ul>	<ul style="list-style-type: none"> <li>Set <math>n2-02 &lt; n2-03</math>.</li> <li>Set <math>C4-02 &lt; C4-06</math>.</li> </ul>
		In OLV/PM control, $E5-02$ to $E5-07$ [PM Motor Parameters] = 0.	<ul style="list-style-type: none"> <li>Set <math>E5-01</math> [PM Motor Code Selection] correctly as specified by the motor.</li> <li>For specialized motors, refer to the motor test report and set <math>E5-xx</math> correctly.</li> </ul>
		In PM motor control methods: <ul style="list-style-type: none"> <li><math>E5-09 = 0.0</math> [PM Back-EMF <math>V_{peak}</math> (mV/(rad/s)) = 0.0 mV/(rad/s)]</li> <li><math>E5-24 = 0.0</math> [PM Back-EMF L-L <math>V_{rms}</math> (mV/rpm) = 0.0 mV/min<sup>-1</sup>]</li> </ul>	Set $E5-09$ or $E5-24$ to the correct value.

## 6.6 Parameter Setting Errors

Code	Name	Causes	Possible Solutions
		In PM motor control methods, $E5-09 \neq 0$ and $E5-24 \neq 0$ .	Set $E5-09 = 0$ or $E5-24 = 0$ .
		In AOLV/PM control: <ul style="list-style-type: none"> <li><math>n8-57 = 0</math> [HFI Overlap Selection = Disabled].</li> <li><math>E1-09</math> [Minimum Output Frequency] is set lower than the lower limit value.</li> </ul>	Correct the parameter settings.
Code	Name	Causes	Possible Solutions
oPE09	PID Control Selection Fault	The following parameters are set at the same time: <ul style="list-style-type: none"> <li><math>b5-15 \neq 0.0</math> [PID Sleep Function Start Level <math>\neq 0.0</math> Hz]</li> <li><math>b1-03 = 2, 3</math> [Stopping Method Selection = DC Injection Braking to Stop, Coast to Stop with Timer]</li> </ul>	<ul style="list-style-type: none"> <li>Set <math>b5-15 \neq 0.0</math>.</li> <li>Set <math>b1-03 = 0, 1</math> [Ramp to Stop, Coast to Stop].</li> </ul>
		The following parameters are set at the same time: <ul style="list-style-type: none"> <li><math>b5-01 = 1, 2</math> [Standard, Standard (D on feedback)]</li> <li><math>d2-02 \neq 0.0</math> [Frequency Reference Lower Limit <math>\neq 0.0\%</math>]</li> </ul>	Correct the parameter settings.
		The following parameters are set at the same time: <ul style="list-style-type: none"> <li><math>b5-01 = 1, 2</math> [Standard, Standard (D on feedback)]</li> <li><math>b5-11 = 1</math> [PID Output Reverse Selection = Negative Output Accepted]</li> </ul>	Correct the parameter settings.
		The following parameters are set at the same time: <ul style="list-style-type: none"> <li><math>b5-01 = 3, 4</math> [Fref + PID Trim, D = Fdbk), Fref + PID Trim (D on feedback)]</li> <li><math>d2-02 \neq 0.0</math></li> </ul>	Correct the parameter settings.
<p><b>Note:</b>  The drive detects this error if the PID control function selection is incorrect.  (When <math>b5-01 = 1</math> to <math>4</math> [PID Mode Setting = PID Control Enabled])</p>			
Code	Name	Causes	Possible Solutions
oPE10	V/f Data Setting Error	The parameters that set the V/f pattern do not satisfy these conditions: <ul style="list-style-type: none"> <li>For motor 1: <math>E1-09 \leq E1-07 &lt; E1-06 \leq E1-11 \leq E1-04</math> [Minimum Output Frequency <math>\leq</math> Mid Point A Frequency <math>&lt;</math> Base Frequency <math>\leq</math> Mid Point B Frequency <math>\leq</math> Maximum Output Frequency]</li> <li>For motor 2: <math>E3-09 \leq E3-07 &lt; E3-06 \leq E3-11 \leq E3-04</math> [Minimum Output Frequency <math>\leq</math> Mid Point A Frequency <math>&lt;</math> Base Frequency <math>\leq</math> Mid Point B Frequency <math>\leq</math> Maximum Output Frequency]</li> </ul>	Set the parameters correctly to satisfy the conditions.

Code	Name	Causes	Possible Solutions
oPE11	Carrier Frequency Setting Error	The following parameters are set at the same time: <ul style="list-style-type: none"> <li>• <math>C6-05 &gt; 6</math> [<i>Carrier Freq Proportional Gain &gt; 6</i>]</li> <li>• <math>C6-04 &gt; C6-03</math> [<i>Carrier Frequency Lower Limit &gt; Carrier Frequency Upper Limit</i>]</li> </ul> <p><b>Note:</b> When <math>C6-05 &lt; 7</math>, <math>C6-04</math> becomes disabled. <math>C6-03</math> stays active.</p>	Set $C6-02$ to $C6-05$ correctly.
		$C6-02$ to $C6-05$ settings are not in the applicable setting range.	
Code	Name	Causes	Possible Solutions
oPE13	Pulse Monitor Selection Error	$H6-06 = 101, 102, 105, \text{ or } 116$ [ <i>Terminal MP Monitor Selection = Frequency Reference, Output Frequency, Motor Speed, Output Frequency after Soft Starter</i> ] has not been set when $H6-07 = 0$ [ <i>Terminal MP Frequency Scaling = 0 Hz</i> ].	Set $H6-06$ correctly.
Code	Name	Causes	Possible Solutions
oPE15	Torque Control Setting Error	More than one parameter is selecting torque control at the same time. <ul style="list-style-type: none"> <li>• <math>d5-01 = 1</math> [<i>Torque Control Selection = Torque Control</i>]</li> <li>• <math>H1-xx = 71</math> [<i>MFDI Function Select = Torque Control</i>]</li> </ul>	Correct the parameter settings.
		Droop control and Feed Forward control are enabled at the same time that torque control is selected. <ul style="list-style-type: none"> <li>• <math>d5-01 = 1</math> or <math>H1-xx = 71</math></li> <li>• <math>b7-01 \neq 0.0</math> [<i>Droop Control Gain <math>\neq</math> 0.0%</i>] or <math>n5-01 = 1</math> [<i>Feed Forward Control Selection = Enabled</i>]</li> </ul>	Correct the parameter settings.
		KEB Ride-Thru 2 (N.O., N.C.) is enabled at the same time that torque control is selected. <ul style="list-style-type: none"> <li>• <math>d5-01 = 1</math> or <math>H1-xx = 71</math></li> <li>• <math>H1-xx = 7A</math> [<i>KEB Ride-Thru 2 Activate (N.C.)</i>] or <math>H1-xx = 7B</math> [<i>KEB Ride-Thru 2 Activate (N.O.)</i>]</li> </ul>	Correct the parameter settings.
		Optimal deceleration or overexcitation deceleration 2 is enabled at the same time that torque control is selected. <ul style="list-style-type: none"> <li>• <math>d5-01 = 1</math> or <math>H1-xx = 71</math></li> <li>• <math>L3-04 = 2, 5</math> [<i>Stall Prevention during Decel = Intelligent (Ignore Decel Ramp), Overexcitation/High Flux 2</i>]</li> </ul>	Correct the parameter settings.
Code	Name	Causes	Possible Solutions
oPE16	Energy Saving Constants Error	The Energy Saving parameters are not set in the applicable setting range.	Make sure that $E5-xx$ is set correctly as specified by the motor nameplate data.
Code	Name	Causes	Possible Solutions
oPE18	Online Tuning Param Setting Err	The parameters that control online tuning are set incorrectly. In OLV control, one of these parameters was set when $n6-01 = 2$ [ <i>Online Tuning Selection = Voltage Correction Tuning</i> ]: <ul style="list-style-type: none"> <li>• <math>E2-02</math> [<i>Motor Rated Slip</i>] is set to 30% of the default setting or lower.</li> <li>• <math>E2-06</math> [<i>Motor Leakage Inductance</i>] is set to 50% of the default setting or lower.</li> <li>• <math>E2-03 = 0</math> [<i>Motor No-Load Current = 0 A</i>] has been set.</li> </ul>	Set $E2-02$ , $E2-03$ , and $E2-06$ correctly.

## 6.6 Parameter Setting Errors

Code	Name	Causes	Possible Solutions
oPE20	PG-F3 Setting Error	The value set in <i>F1-01 [Encoder 1 Pulse Count (PPR)]</i> does not agree with the number of encoder pulses.	<ul style="list-style-type: none"> <li>Examine the <i>F1-01</i> value and the number of encoder pulses.</li> <li>Set <i>F1-01</i> correctly.</li> </ul>
		The calculation encoder signal frequency at maximum speed is more than 20 kHz.	Decrease the value set for <i>E1-04 [Maximum Output Frequency]</i> and make sure that the output frequency of the encoder is not more than 20 kHz.
Code	Name	Causes	Possible Solutions
oPE33	Digital Output Selection Error	<p>These two parameters are set at the same time:</p> <ul style="list-style-type: none"> <li><i>H2-60 ≠ F [Term M1-M2 Secondary Function ≠ Not Used]</i></li> <li><i>H2-01 = 1xx [Term M1-M2 Function Selection = Inverse output of xx]</i></li> </ul>	<p>Clear the <i>H2-01 to H2-03 = 1xx [Inverse output of xx]</i> settings.</p> <p><b>Note:</b> It is not possible to set <i>H2-01 to H2-03 = 1xx [Inverse output of xx]</i> when using output functions for logic operations (<i>H2-60, H2-63, H2-66 ≠ F</i>).</p>
		<p>These two parameters are set at the same time:</p> <ul style="list-style-type: none"> <li><i>H2-63 ≠ F [Term M3-M4 Secondary Function ≠ Not Used]</i></li> <li><i>H2-02 = 1xx [Term M3-M4 Function Selection = Inverse output of xx]</i></li> </ul>	
		<p>These two parameters are set at the same time:</p> <ul style="list-style-type: none"> <li><i>H2-66 ≠ F [Term M5-M6 Secondary Function ≠ Not Used]</i></li> <li><i>H2-03 = 1xx [Term M5-M6 Function Selection = Inverse output of xx]</i></li> </ul>	
		<p>These parameter pairs are set incorrectly:</p> <ul style="list-style-type: none"> <li><i>H2-21 [Comparator 1 Lower Limit] &gt; H2-22 [Comparator 1 Upper Limit]</i></li> <li><i>H2-27 [Comparator 2 Lower Limit] &gt; H2-28 [Comparator 2 Upper Limit]</i></li> </ul>	

## 6.7 Auto-Tuning Errors


This table gives information about errors detected during Auto-Tuning. If the drive detects an Auto-Tuning error, the keypad will show the error and the motor will coast to stop. The drive will not send notification signals for faults and alarms when Auto-Tuning errors occur.

Two types of Auto-Tuning errors are: *Endx* and *Erx*. *Endx* identifies that Auto-Tuning has successfully completed with calculation errors. Find and repair the cause of the error and do Auto-Tuning again, or set the motor parameters manually. You can use the drive in the application if you cannot find the cause of the *Endx* error.

*Erx* identifies that Auto-Tuning was not successful. Find and repair the cause of the error and do Auto-Tuning again.

Code	Name	Causes	Possible Solutions
End1	Excessive Rated Voltage Setting	The torque reference was more than 20% during Auto-Tuning or the no-load current that was measured after Auto-Tuning is more than 80%.	<ul style="list-style-type: none"> <li>Make sure that the input motor nameplate data is correct.</li> <li>Do Auto-Tuning again and correctly set the motor nameplate data.</li> <li>If you can uncouple the motor and load, remove the motor from the machine and do Rotational Auto-Tuning again.</li> <li>If you cannot uncouple the motor and load, use the results from Auto-Tuning.</li> </ul>
Code	Name	Causes	Possible Solutions
End2	Iron Core Saturation Coefficient	The motor nameplate data entered during Auto-Tuning is incorrect.	<ul style="list-style-type: none"> <li>Make sure that the input motor nameplate data is correct.</li> <li>Do Auto-Tuning again and correctly set the motor nameplate data.</li> </ul>
		Auto-Tuning results were not in the applicable parameter setting range, and <i>E2-07</i> or <i>E2-08</i> [ <i>Motor Saturation Coefficient 2</i> ] have temporary values.	<ul style="list-style-type: none"> <li>Examine and repair damaged motor wiring.</li> <li>If you can uncouple the motor and load, remove the motor from the machine and do Rotational Auto-Tuning again.</li> </ul>
Code	Name	Causes	Possible Solutions
End3	Rated Current Setting Alarm	The rated current value is incorrect.	Do Auto-Tuning again and set the correct rated current shown on the motor nameplate.
Code	Name	Causes	Possible Solutions
End4	Adjusted Slip Calculation Error	The Auto-Tuning results were not in the applicable parameter setting range.	<ul style="list-style-type: none"> <li>Make sure the input motor nameplate data is correct.</li> <li>Do Rotational Auto-Tuning again and correctly set the motor nameplate data.</li> <li>If you cannot uncouple the motor and load, do Stationary Auto-Tuning 2.</li> </ul>
		The motor rated slip that was measured after Stationary Auto-Tuning was 0.2 Hz or lower.	
		The motor rated slip that was measured after compensation with <i>E2-08</i> [ <i>Motor Saturation Coefficient 2</i> ] is not in the applicable range.	
		The secondary resistor measurement results were not in the applicable range.	
Code	Name	Causes	Possible Solutions
End5	Resistance Tuning Error	The Auto-Tuning results of the Line-to-Line Resistance were not in the applicable range.	<ul style="list-style-type: none"> <li>Make sure that the input motor nameplate data is correct.</li> <li>Examine and repair damaged motor wiring.</li> </ul>
Code	Name	Causes	Possible Solutions
End6	Leakage Inductance Alarm	The Auto-Tuning results were not in the applicable parameter setting range.	Make sure that the input motor nameplate data is correct, and do Auto-Tuning again.
		<i>A1-02</i> [ <i>Control Method Selection</i> ] setting is not applicable.	<ul style="list-style-type: none"> <li>Examine the value set in <i>A1-02</i>.</li> <li>Make sure that the input motor nameplate data is correct, and do Auto-Tuning again.</li> </ul>

## 6.7 Auto-Tuning Errors

Code	Name	Causes	Possible Solutions
End7	No-Load Current Alarm	The Auto-Tuning results of the motor no-load current value were not in the applicable range.	Examine and repair damaged motor wiring.
		Auto-Tuning results were less than 5% of the motor rated current.	Make sure that the input motor nameplate data is correct, and do Auto-Tuning again.
Code	Name	Causes	Possible Solutions
Er-01	Motor Data Error	The motor nameplate data entered during Auto-Tuning is incorrect.	<ul style="list-style-type: none"> <li>Make sure that the input motor nameplate data is correct.</li> <li>Do Auto-Tuning again and correctly set the motor nameplate data.</li> </ul>
		The combination of the motor rated power and motor rated current do not match.	<ul style="list-style-type: none"> <li>Examine the combination of drive capacity and motor output.</li> <li>Do Auto-Tuning again, and correctly set the motor rated power and motor rated current.</li> </ul>
		The combination of the motor rated current that was entered during Auto-Tuning and <i>E2-03 [Motor No-Load Current]</i> do not match.	<ol style="list-style-type: none"> <li>Examine the motor rated current and the no-load current.</li> <li>Set <i>E2-03</i> correctly.</li> <li>Do Auto-Tuning again, and correctly set the motor rated current.</li> </ol>
		The combination of the setting values of Motor Base Frequency and Motor Base Speed do not match.	Do Auto-Tuning again, and correctly set the Motor Base Frequency and Motor Base Speed.
Code	Name	Causes	Possible Solutions
Er-02	Drive in an Alarm State	The motor nameplate data entered during Auto-Tuning is incorrect.	<ul style="list-style-type: none"> <li>Make sure that the input motor nameplate data is correct.</li> <li>Do Auto-Tuning again and correctly set the motor nameplate data.</li> </ul>
		There is a defective motor cable or cable connection.	Examine and repair motor wiring.
		The load is too heavy.	<ul style="list-style-type: none"> <li>Decrease the load.</li> <li>Examine the machine area to see if, for example, the motor shaft is locked.</li> </ul>
		The drive detected a minor fault during Auto-Tuning.	<ol style="list-style-type: none"> <li>Stop Auto-Tuning.</li> <li>Examine the minor fault code and remove the cause of the problem.</li> <li>Do Auto-Tuning again.</li> </ol>
Code	Name	Causes	Possible Solutions
Er-03	STOP Button was Pressed	During Auto-Tuning,  was pushed and Auto-Tuning was interrupted.	Auto-Tuning did not complete correctly. Do Auto-Tuning again.
Code	Name	Causes	Possible Solutions
Er-04	Line-to-Line Resistance Error	The Auto-Tuning results were not in the applicable parameter setting range.	<ul style="list-style-type: none"> <li>Examine and repair motor wiring.</li> <li>Disconnect the machine from the motor and do Rotational Auto-Tuning again.</li> </ul>
		Auto-Tuning did not complete in a pre-set length of time.	
		There is a defective motor cable or cable connection.	
		The motor nameplate data entered during Auto-Tuning is incorrect.	<ul style="list-style-type: none"> <li>Make sure that the input motor nameplate data is correct.</li> <li>Do Auto-Tuning again and correctly set the motor nameplate data.</li> </ul>

Code	Name	Causes	Possible Solutions
Er-05	No-Load Current Error	The Auto-Tuning results were not in the applicable parameter setting range.	<ul style="list-style-type: none"> <li>Examine and repair motor wiring.</li> <li>Disconnect the machine from the motor and do Rotational Auto-Tuning again.</li> </ul>
		Auto-Tuning did not complete in a pre-set length of time.	
		The motor nameplate data entered during Auto-Tuning is incorrect.	<ul style="list-style-type: none"> <li>Make sure that the input motor nameplate data is correct.</li> <li>Do Auto-Tuning again and correctly set the motor nameplate data.</li> </ul>
		Rotational Auto-Tuning was done with a load that was more than 30% of the rating connected to the motor.	<ul style="list-style-type: none"> <li>Disconnect the machine from the motor and do Rotational Auto-Tuning again.</li> <li>If you cannot uncouple the motor and load, make sure that the load is less than 30% of the motor rating. If a mechanical brake is installed in the motor, release the brake during Rotational Auto-Tuning.</li> </ul>
Code	Name	Causes	Possible Solutions
Er-08	Rated Slip Error	The motor nameplate data entered during Auto-Tuning is incorrect.	<ul style="list-style-type: none"> <li>Make sure that the input motor nameplate data is correct.</li> <li>Do Auto-Tuning again and correctly set the motor nameplate data.</li> </ul>
		Auto-Tuning did not complete in a pre-set length of time.	<ul style="list-style-type: none"> <li>Examine and repair the motor wiring.</li> <li>If the motor and machine are connected during Rotational Auto-Tuning, decouple the motor from the machinery.</li> </ul>
		The Auto-Tuning results were not in the applicable parameter setting range.	
		Rotational Auto-Tuning was done with a load that was more than 30% of the rating connected to the motor.	<ul style="list-style-type: none"> <li>Disconnect the machine from the motor and do Rotational Auto-Tuning again.</li> <li>If you cannot uncouple the motor and load, make sure that the load is less than 30% of the motor rating. If a mechanical brake is installed in the motor, release the brake during Rotational Auto-Tuning.</li> </ul>
Code	Name	Causes	Possible Solutions
Er-09	Acceleration Error	The motor did not accelerate for the specified acceleration time.	<ol style="list-style-type: none"> <li>Increase the value set in <i>C1-01 [Acceleration Time 1]</i>.</li> <li>Disconnect the machine from the motor and do Rotational Auto-Tuning again.</li> </ol>
		The value of <i>L7-01</i> or <i>L7-02 [Forward/Reverse Torque Limit]</i> is small.	Increase the value set in <i>L7-01</i> or <i>L7-02</i> .
		Rotational Auto-Tuning was done with a load that was more than 30% of the rating connected to the motor.	<ul style="list-style-type: none"> <li>Disconnect the machine from the motor and do Rotational Auto-Tuning again.</li> <li>If you cannot uncouple the motor and load, make sure that the load is less than 30% of the motor rating. If a mechanical brake is installed in the motor, release the brake during Rotational Auto-Tuning.</li> </ul>
Code	Name	Causes	Possible Solutions
Er-10	Motor Direction Error	There is defective drive and motor wiring.	Examine and repair motor wiring.
		There is defective drive and encoder wiring.	Examine and repair the wiring to the encoder.
		The direction of the motor and the setting of <i>F1-05 [PG 1 Rotation Selection]</i> are opposite.	Set <i>F1-05</i> correctly.
		The machine pulled the motor to rotate in the opposite direction.	Disconnect the machine from the motor and do Rotational Auto-Tuning again.
		When the torque reference is 100% or higher, the sign of the speed reference was opposite of the detected speed.	

## 6.7 Auto-Tuning Errors

Code	Name	Causes	Possible Solutions
Er-11	Motor Speed Error	The torque reference during acceleration is too high (100%).	<ul style="list-style-type: none"> <li>• Increase the value set in <i>C1-01 [Acceleration Time 1]</i>.</li> <li>• Disconnect the machine from the motor and do Rotational Auto-Tuning again.</li> </ul>
Code	Name	Causes	Possible Solutions
Er-12	Current Detection Error	There is a phase loss in the drive input power. (U/T1, V/T2, W/T3)	Examine and repair motor wiring.
		The current exceeded the current rating of the drive.	<ul style="list-style-type: none"> <li>• Check the motor wiring for any short circuits between the wires.</li> <li>• Check and turn ON any magnetic contactors used between motors.</li> <li>• Replace the control board or the drive. For information about replacing the control board, contact Yaskawa or your nearest sales representative.</li> </ul>
		The output current is too low.	
		You tried Auto-Tuning without a motor connected to the drive.	Connect the motor and do Auto-Tuning.
		There was a current detection signal error.	Replace the control board or the drive. For information about replacing the control board, contact Yaskawa or your nearest sales representative.
Code	Name	Causes	Possible Solutions
Er-13	Leakage Inductance Error	The motor rated current value is incorrect.	Correctly set the rated current indicated on the motor nameplate and perform Auto-Tuning again.
		The drive could not complete tuning for leakage inductance in fewer than 300 seconds.	Examine and repair motor wiring.
Code	Name	Causes	Possible Solutions
Er-14	Motor Speed Error 2	The motor speed was more than two times the amplitude of speed reference during Inertia Tuning.	Decrease the value set in <i>C5-01 [ASR Proportional Gain 1]</i> .
Code	Name	Causes	Possible Solutions
Er-15	Torque Saturation Error	During Inertia Tuning, the output torque was more than the value set in <i>L7-01 to L7-04 [Torque Limit]</i> .	<ul style="list-style-type: none"> <li>• Increase the value set in <i>L7-01 to L7-04 [Torque Limit]</i> as much as possible.</li> <li>• Decrease the values set for the frequency and amplitude of the test signals used when doing inertia tuning. First, decrease the test signal amplitude, and then do Inertia Tuning. If the error continues, decrease the test signal frequency and do Inertia Tuning again.</li> </ul>
Code	Name	Causes	Possible Solutions
Er-16	Inertia ID Error	The inertia found by the drive was too small or too large during Inertia Tuning (10% or less, or 50000% or more).	<ul style="list-style-type: none"> <li>• Decrease the values set for the frequency and amplitude of the test signals used when doing inertia tuning. First, decrease the test signal amplitude, and then do Inertia Tuning. If the error continues, decrease the test signal frequency and do Inertia Tuning again</li> <li>• Correctly set the motor inertia as specified by the motor, and do Inertia Tuning again.</li> </ul>
Code	Name	Causes	Possible Solutions
Er-17	Reverse Prohibited Error	<p><i>b1-04 = 1 [Reverse Operation Selection = Reverse disabled]</i> has been set.</p> <p><b>Note:</b> You cannot do Inertia Tuning if the drive cannot rotate the motor in reverse.</p>	<ol style="list-style-type: none"> <li>1. Enable reverse in the target machine.</li> <li>2. Set <i>b1-04 = 0 [Reverse enabled]</i>.</li> <li>3. Do Inertia Tuning again.</li> </ol>
Code	Name	Causes	Possible Solutions
Er-18	Back EMF Error	The result of the induced voltage tuning was not in the applicable range.	<ol style="list-style-type: none"> <li>1. Make sure that the input motor nameplate data is correct.</li> <li>2. Do Auto-Tuning again and correctly set the motor nameplate data.</li> </ol>



Code	Name	Causes	Possible Solutions
Er-19	PM Inductance Error	The Auto-Tuning results of the PM motor inductance were not in the applicable range.	<ol style="list-style-type: none"> <li>1. Make sure that the input motor nameplate data is correct.</li> <li>2. Do Auto-Tuning again and correctly set the motor nameplate data.</li> </ol>
Code	Name	Causes	Possible Solutions
Er-20	Stator Resistance Error	The Auto-Tuning results of the PM Motor Stator Resistance were not in the applicable range.	<ol style="list-style-type: none"> <li>1. Make sure that the input motor nameplate data is correct.</li> <li>2. Do Auto-Tuning again and correctly set the motor nameplate data.</li> </ol>
Code	Name	Causes	Possible Solutions
Er-21	Z Pulse Correction Error	The motor is wired incorrectly.	<ol style="list-style-type: none"> <li>1. Repair motor and encoder wiring errors.</li> <li>2. Do Z Pulse Offset Tuning again.</li> </ol>
		The encoder is wired incorrectly.	
		Auto-Tuning was performed when the motor was coasting.	<ol style="list-style-type: none"> <li>1. Make sure that the motor has stopped completely.</li> <li>2. Do Z Pulse Offset Tuning again.</li> </ol>
		The setting for the direction of the encoder motor rotation is incorrect.	<ol style="list-style-type: none"> <li>1. Set the direction of motor rotation of the encoder in <i>F1-05 [PG 1 Rotation Selection]</i> correctly.</li> <li>2. Do Z Pulse Offset Tuning again.</li> </ol>
		The number of encoder pulses is incorrect.	<ol style="list-style-type: none"> <li>1. Set the number of encoder pulses in <i>F1-01 [PG 1 Pulses Per Revolution]</i> correctly.</li> <li>2. Do Z Pulse Offset Tuning again.</li> </ol>
		The encoder is damaged.	<ul style="list-style-type: none"> <li>• Examine the signal output from the encoder.</li> <li>• Replace the encoder.</li> </ul>
Code	Name	Causes	Possible Solutions
Er-25	HighFreq Inject Param Tuning Err	The motor data is incorrect.	<p>Do Stationary Auto-Tuning again.</p> <p><b>Note:</b> If the drive detects <i>Er-25</i> after doing Stationary Auto-Tuning, the motor may not be able to use high frequency injection control. For details, contact Yaskawa or your nearest sales representative.</p>

## 6.8 Backup Function Operating Mode Display and Errors

### ◆ Operating Mode Display

When doing the backup function tasks, the keypad will show the current task. These indicators do not show that an error has occurred.

Keypad Display	Name	Display	State
Drive and Keypad mismatch. Should the parameters be restored?	Detection of inconsistency between the drive and keypad	Normally displayed	The drive detected the connection of a keypad from a different drive. Select [Yes] to copy parameters backed up in the keypad to the connected drive.
Restore Restore from keypad	Restoring parameters	Flashing	The parameters stored in the keypad have been restored to the drive.
End	Backup/restore/verify operation ended normally	Normally displayed	The parameter backup, restore, or verify operation ended normally.
Backup Backup from Drive	Backing up parameters	Flashing	The parameters stored in the drive are being backed up to the keypad.
Verify Keypad & Drive	Verifying parameters	Flashing	The parameter settings stored in the keypad and the parameter settings in the drive match or are being compared.

### ◆ Backup Function Runtime Errors

When an error occurs, the keypad shows a code to identify the error.

The table in this section show the error codes. Refer to these tables to remove the cause of the errors.

**Note:**

Push any key on the keypad to clear an error.

Code	Name	Causes	Possible Solutions
CPEr	Control Mode Mismatch	The keypad setting and drive setting for <i>A1-02 [Control Method Selection]</i> do not match.	1. Set <i>A1-02</i> on the drive to the same value that is on the keypad. 2. Restore the parameters.
Code	Name	Causes	Possible Solutions
CPyE	Error Writing Data	Parameter restore did not end correctly.	Restore the parameters.
Code	Name	Causes	Possible Solutions
CSEr	Control Mode Mismatch	The keypad is broken.	Replace the keypad.
Code	Name	Causes	Possible Solutions
dFPS	Drive Model Mismatch	An attempt was made to restore parameters that were backed up on a different drive model.	1. Examine the drive model that was used to back up the parameters on the keypad. 2. Restore the parameters.
Code	Name	Causes	Possible Solutions
iFEr	Keypad Communication Error	There was a communications error between the keypad and the drive.	Examine the connector or cable connection.
Code	Name	Causes	Possible Solutions
ndAT	Error Received Data	The parameter settings for model and specifications (power supply voltage and capacity) are different between the keypad and the drive.	1. Make sure that drive model and the value set in <i>o2-04 [Drive Model (KVA) Selection]</i> are the same. 2. Restore the parameters.
		The parameters are not stored in the keypad.	1. Connect a keypad that has the correct parameters. 2. Restore the parameters.

Code	Name	Causes	Possible Solutions
rdEr	Error Reading Data	Backup was executed with <i>o3-02 = 0</i> [ <i>Copy Allowed Selection = Disabled</i> ] set.	Set <i>o3-02 = 1</i> [ <i>Enabled</i> ] and backup again.
Code	Name	Causes	Possible Solutions
vAEr	Voltage Class, Capacity Mismatch	The power supply specifications or drive capacity parameter settings are different between the keypad and the drive.	<ol style="list-style-type: none"> <li>1. Make sure that drive model and the value set in <i>o2-04</i> [<i>Drive Model (KVA) Selection</i>] are the same.</li> <li>2. Restore the parameters.</li> </ol>
Code	Name	Causes	Possible Solutions
vFyE	Parameters do not Match	The parameters that are backed up in the keypad and the parameters in the drive are not the same.	<ol style="list-style-type: none"> <li>1. Restore or backup the parameter again.</li> <li>2. Verify the parameters.</li> </ol>

## 6.9 Diagnosing and Resetting Faults

When a fault occurs and the drive stops, do the procedures in this section to remove the cause of the fault, then re-energize the drive.

### ◆ Fault and Power Loss Occur at the Same Time

**WARNING! Sudden Movement Hazard.** Do not do work on the drive without eye protection. Wear eye protection before you start work on the drive. Failure to obey could cause serious injury or death.

**WARNING! Electrical Shock Hazard.** Do not immediately energize the drive or operate peripheral devices after the drive blows a fuse or trips an RCM/RCD. Wait for the time specified on the warning label at a minimum and make sure that all indicators are OFF. Then check the wiring and peripheral device ratings to find the cause of the problem. Contact Yaskawa before energizing the drive or peripheral devices if the cause is not known. Failure to obey can cause death or serious injury and damage to the drive.

1. Supply power to the control circuit from the external 24 V input.
2. Use monitor parameters  $U2-xx$  [Fault Trace] to show the fault code and data about the operating status of the drive immediately before the fault occurred.
3. Use the information in the Troubleshooting tables to remove the fault.

**Note:**

1. To find the faults that were triggered, check the fault history in  $U2-02$  [Previous Fault]. To find information about drive status (such as frequency, current, and voltage) when the faults were triggered, check  $U2-03$  to  $U2-20$ .
2. If the fault display stays after you re-energize the drive, remove the cause of the fault and reset.


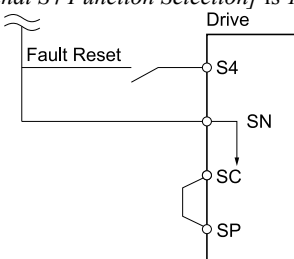
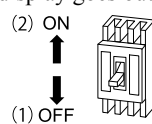
### ◆ Fault Occurs Without Power Loss

1. Examine the fault code shown on the keypad.
2. Use the information in the Troubleshooting tables to remove the fault.
3. Do a fault reset.

### ◆ Fault Reset

If a fault occurs, you must remove the cause of the fault and re-energize the drive. Table 6.3 lists the different methods to reset the drive after a fault.

**Table 6.3 Fault Reset Methods**

Methods	Description
Method 1	While the keypad is showing the fault or alarm code, push <b>F1</b> (Reset) or  on the keypad.
Method 2	<p>Switch ON the MFDI terminal set to <math>H1-xx = 14</math> [MFDI Function Select = Fault Reset].</p> <p><b>Note:</b> The default setting for <math>H1-04</math> [Terminal S4 Function Selection] is 14 [Fault Reset].</p> 
Method 3	<ol style="list-style-type: none"> <li>1. De-energize the drive main circuit power supply.</li> <li>2. Energize the drive again after the keypad display goes out.</li> </ol> 

**Note:**

If the drive receives a Run command from a communication option or control circuit terminal, the drive will not reset the fault. Remove the Run command then try to clear the fault. If you do a fault reset when the drive has a Run command, the keypad will show minor fault  $CrST$  [Remove RUN Command to Reset].

## 6.10 Troubleshooting Without Fault Display

If the drive or motor operate incorrectly, but the keypad does not show a fault or error code, refer to the items this section.

- Motor hunting and oscillation
- Unsatisfactory motor torque
- Unsatisfactory speed precision
- Unsatisfactory motor torque and speed response
- Motor noise




### ◆ The Parameter Settings Will Not Change

Causes	Possible Solutions
The drive is operating the motor (the drive is in Drive Mode).	Stop the drive and change to Programming Mode.
Parameter $A1-01 = 0$ [Access Level Selection = Operation Only].	Set $A1-01 = 2$ [Access Level Selection = Advanced Level] or $A1-01 = 3$ [Expert Level].
Parameter $H1-xx = 1B$ [MFDI Function Select = Programming Lockout].	Turn ON the terminals to which $H1-xx = 1B$ is set, and then change the parameters.
An incorrect password was entered in $A1-04$ [Password].	<ul style="list-style-type: none"> <li>• Enter the correct password to <math>A1-04</math> again.</li> <li>• If you forgot the password, set the password again with <math>A1-04</math> and <math>A1-05</math> [Password Setting].</li> </ul> <p><b>Note:</b> If the password is set, it will not be possible to change these parameters until the password matches:</p> <ul style="list-style-type: none"> <li>• <math>A1-01</math> [Access Level Selection]</li> <li>• <math>A1-02</math> [Control Method Selection]</li> <li>• <math>A1-03</math> [Initialize Parameters]</li> <li>• <math>A1-06</math> [Application Preset]</li> <li>• <math>A1-07</math> [DriveWorksEZ Function Selection]</li> <li>• <math>A2-01</math> to <math>A2-32</math> [User Parameter 1 to User Parameter 32]</li> </ul>
The drive detected $Uv$ [Undervoltage].	<ul style="list-style-type: none"> <li>• View <math>U1-07</math> [DC Bus Voltage] to see the power supply voltage.</li> <li>• Examine the main circuit wiring.</li> </ul>

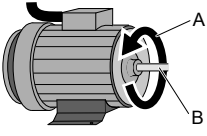
### ◆ The Motor Does Not Rotate After Entering Run Command

Causes	Possible Solutions
The drive is not in Drive Mode.	<ol style="list-style-type: none"> <li>1. Make sure that the keypad shows [Rdy].</li> <li>2. If the keypad does not show [Rdy], go back to the Home screen.</li> </ol>
The drive stopped, <b>LO/RE</b> was pushed, and changed the Run command source to the keypad.	<p>Do one of these two:</p> <ul style="list-style-type: none"> <li>• Push <b>LO/RE</b>.</li> <li>• Re-energize the drive.</li> </ul> <p><b>Note:</b> Set <math>o2-01 = 0</math> [LO/RE Key Function Selection = Disabled] to prevent changing the Run command source with <b>LO/RE</b>.</p>
Auto-Tuning completed.	<p>Go back to the Home screen on the keypad.</p> <p><b>Note:</b> When Auto-Tuning completes, the drive changes to Programming Mode. The drive will not accept a Run command unless the drive is in Drive Mode.</p>
The drive received a fast stop command.	Turn off the fast stop input signal.
The settings for the source that supplies the Run command are incorrect.	Set $b1-02$ [Run Command Selection 1] correctly.
The frequency reference source is set incorrectly.	Set $b1-01$ [Frequency Reference Selection 1] correctly.
There is defective wiring in the control circuit terminals.	<ul style="list-style-type: none"> <li>• Correctly wire the drive control circuit terminals.</li> <li>• View <math>U1-10</math> [Input Terminal Status] for input terminal status.</li> </ul>

## 6.10 Troubleshooting Without Fault Display

Causes	Possible Solutions
The settings for voltage input and current input of the master frequency reference are incorrect.	Examine these analog input terminal signal level settings: <ul style="list-style-type: none"> <li>Terminal A1: DIP switch S1-1 and H3-01 [Terminal A1 Signal Level Select]</li> <li>Terminal A2: DIP switch S1-2 and H3-09 [Terminal A2 Signal Level Select]</li> <li>Terminal A3: DIP switch S4, S1-3 and H3-05 [Terminal A3 Signal Level Select]</li> </ul>
The selection for the sinking/sourcing mode and the internal/external power supply is incorrect.	<ul style="list-style-type: none"> <li>For sinking mode, close the circuit between terminals SC-SP with a wire jumper.</li> <li>For sourcing mode, close the circuit between terminals SC-SN with a wire jumper.</li> <li>For external power supply, remove the wire jumper.</li> </ul>
The frequency reference is too low.	<ul style="list-style-type: none"> <li>View U1-01 [Freq Reference].</li> <li>Increase the frequency reference to a value higher than E1-09 [Minimum Output Frequency].</li> </ul>
The MFAI setting is incorrect.	<ul style="list-style-type: none"> <li>Make sure that the functions set to the MFAI are correct. The frequency reference is 0 when H3-02, H3-10, H3-06 = 1 [MFAI Function Select = Frequency Gain] and voltage (current) is not input.</li> <li>View U1-13 to U1-15 [Terminal A1, A2, A3 Input Voltage] to see if the analog input values set to terminals A1, A2, and A3 are applicable.</li> </ul>
 was pushed.	Turn the Run command OFF then ON from an external input. <b>Note:</b> When you push  during operation, the drive will ramp to stop. Set o2-02 = 0 [STOP Key Function Selection = Disabled] to disable the  function.
The 2-wire sequence and 3-wire sequence are set incorrectly.	<ul style="list-style-type: none"> <li>Set one of the parameters H1-03 to H1-08 [Terminals S3 to S8 Function Select] to 0 [3-Wire Sequence] to enable the 3-wire sequence.</li> <li>If a 2-wire sequence is necessary, make sure that H1-03 to H1-08 <math>\neq</math> 0.</li> </ul>

### ◆ The Motor Rotates in the Opposite Direction from the Run Command

Causes	Possible Solutions
The phase wiring between the drive and motor is incorrect.	<ul style="list-style-type: none"> <li>Examine the wiring between the drive and motor.</li> <li>Connect drive output terminals U/T1, V/T2, and W/T3 in the correct sequence to agree with motor terminals U, V, and W.</li> <li>Switch two motor cables U, V, and W to reverse motor direction.</li> </ul>
The forward direction for the motor is set incorrectly.	<ul style="list-style-type: none"> <li>Connect drive output terminals U/T1, V/T2, and W/T3 in the correct sequence to agree with motor terminals U, V, and W.</li> <li>Switch two motor cables U, V, and W to reverse motor direction.</li> </ul> <div style="text-align: center;">  <p><b>A - For ward Rota tion Direc tion</b>      <b>B - Load Shaft</b></p> </div> <p style="text-align: center;"><b>Figure 6.1 Forward Rotating Motor</b></p> <p><b>Note:</b></p> <ul style="list-style-type: none"> <li>For Yaskawa motors, the forward direction is counterclockwise when looking from the motor shaft side.</li> <li>Refer to the motor specifications, and make sure that the forward rotation direction is correct for the application. The forward rotation direction of motors can be different for different motor manufacturers and types.</li> </ul>

Causes	Possible Solutions
The signal connections for forward run and reverse run on the drive control circuit terminals and control panel side are incorrect.	Correctly wire the control circuit.
The motor is running at almost 0 Hz and the Speed Search estimated the speed to be in the opposite direction.	Set $b3-14 = 0$ [ <i>Bi-directional Speed Search = Disabled</i> ], then the drive will only do speed search in the specified direction.

### ◆ The Motor Rotates in Only One Direction

Causes	Possible Solutions
The drive will not let the motor rotate in reverse.	Set $b1-04 = 0$ [ <i>Reverse Operation Selection = Reverse Enabled</i> ].
The drive did not receive a Reverse run signal and 3-Wire sequence is selected.	Turn ON the terminals to which $H1-xx = 0$ [ <i>3-Wire Sequence</i> ] is set, and then enable reverse operation.

### ◆ The Motor Is Too Hot

Causes	Possible Solutions
The load is too heavy.	<ul style="list-style-type: none"> <li>Decrease the load.</li> <li>Increase the acceleration and deceleration times.</li> <li>Examine the values set in <math>L1-01</math> [<i>Motor Overload (oL1) Protection</i>], <math>L1-02</math> [<i>Motor Overload Protection Time</i>], and <math>E2-01</math> [<i>Motor Rated Current (FLA)</i>].</li> <li>Use a larger motor.</li> </ul> <p><b>Note:</b> The motor also has a short-term overload rating. Examine this rating carefully before setting drive parameters.</p>
The motor is running continuously at a very low speed.	<ul style="list-style-type: none"> <li>Change the run speed.</li> <li>Use a drive-dedicated motor.</li> </ul>
The drive is operating in a vector control mode, but Auto-Tuning has not been done.	<ul style="list-style-type: none"> <li>Do Auto-Tuning.</li> <li>Calculate motor parameter and set motor parameters.</li> <li>Set <math>A1-02 = 0</math> [<i>Control Method Selection = V/f Control</i>].</li> </ul>
The voltage insulation between motor phases is not sufficient.	<ul style="list-style-type: none"> <li>Use a motor with a voltage tolerance that is higher than the maximum voltage surge.</li> <li>Use a drive-dedicated motor that is rated for use with AC drives for applications that use a motor on drives rated higher than 400 V class.</li> <li>Install an AC reactor on the output side of the drive and set <math>C6-02 = 1</math> [<i>Carrier Frequency Selection = 2.0 kHz</i>].</li> </ul> <p><b>Note:</b> When the motor is connected to the drive output terminals U/T1, V/T2, and W/T3, surges occur between the drive switching and the motor coils. These surges can be three times the drive input power supply voltage (600 V for a 200 V class drive, 1200 V for a 400 V class drive).</p>
The air around the motor is too hot.	<ul style="list-style-type: none"> <li>Measure the ambient temperature.</li> <li>Decrease the temperature in the area until it is in the specified temperature range.</li> </ul>
The motor fan stopped or is clogged.	<ul style="list-style-type: none"> <li>Clean the motor fan.</li> <li>Make the drive environment better.</li> </ul>

### ◆ The Correct Auto-Tuning Mode Is Not Available

Causes	Possible Solutions
The desired Auto-Tuning mode is not available for the selected control mode.	Change the motor control method with parameter $A1-02$ [ <i>Control Method Selection</i> ].

## ◆ The Motor Stalls during Acceleration or Accel/Decel Time Is Too Long

Causes	Possible Solutions
The drive and motor system reached the torque limit or current suppression will not let the drive accelerate.	<ul style="list-style-type: none"> <li>Decrease the load.</li> <li>Use a larger motor.</li> </ul> <p><b>Note:</b> Although the drive has a Stall Prevention function and a Torque Compensation Limit function, accelerating too fast or trying to drive a load that is too large can exceed the limits of the motor.</p>
Torque limit is set incorrectly.	Set the torque limit correctly.
The acceleration time setting is too short.	Check the values set in <i>C1-01</i> , <i>C1-03</i> , <i>C1-05</i> , or <i>C1-07</i> [ <i>Acceleration Time</i> ] and set them to applicable values.
The load is too heavy.	<ul style="list-style-type: none"> <li>Increase the acceleration time.</li> <li>Examine the mechanical brake and make sure that it is fully releasing.</li> <li>Decrease the load to make sure that the output current stays less than the motor rated current.</li> <li>Use a larger motor.</li> </ul> <p><b>Note:</b></p> <ul style="list-style-type: none"> <li>In extruder and mixer applications, the load can increase as the temperature decreases.</li> <li>Although the drive has a Stall Prevention function and a Torque Compensation Limit function, accelerating too fast or trying to drive a load that is too large can exceed the limits of the motor.</li> </ul>
The frequency reference is low.	<ul style="list-style-type: none"> <li>Examine <i>E1-04</i> [<i>Maximum Output Frequency</i>] and increase the setting if it is set too low.</li> <li>Examine <i>U1-01</i> [<i>Frequency Reference</i>] for the correct frequency reference.</li> <li>Examine the multi-function input terminals to see if a frequency reference signal switch has been set.</li> <li>Examine the low gain level set in <i>H3-03</i>, <i>H3-11</i>, <i>H3-07</i> [<i>Terminal A1, A2, A3 Gain Setting</i>] if you use MFAI.</li> </ul>
The frequency reference is set incorrectly.	<p>When <i>H3-02</i>, <i>H3-10</i>, <i>H3-06</i> = 1 [<i>MFAI Function Select = Frequency Gain</i>] are set, see if voltage (current) has been set.</p> <ul style="list-style-type: none"> <li>Check the values set in <i>H3-02</i>, <i>H3-10</i>, and <i>H3-06</i>.</li> <li>Use <i>U1-13</i> to <i>U1-15</i> [<i>Terminal A1, A2, A3 Input Voltage</i>] to make sure that the analog input values set to terminals A1, A2, and A3 are applicable.</li> </ul>
The motor characteristics and drive parameter settings are not compatible.	<ul style="list-style-type: none"> <li>Set the correct V/f pattern to agree with the characteristics of the motor.</li> <li>Examine the V/f pattern set in <i>E1-03</i> [<i>V/f Pattern Selection</i>].</li> <li>Perform Rotational Auto-Tuning.</li> </ul>
The drive is operating in vector control mode, but Auto-Tuning is not completed.	<ul style="list-style-type: none"> <li>Do Auto-Tuning.</li> <li>Calculate motor data and reset motor parameters.</li> <li>Set <i>A1-02</i> = 0 [<i>Control Method Selection = V/f Control</i>].</li> </ul>
Parameter <i>A1-02</i> = 4 [ <i>Control Method Selection = Advanced Open Loop Vector</i> ] and the speed estimation response is too slow.	Increase the value set in <i>n4-65</i> [ <i>Flux Estimate Response@High Freq</i> ] in 0.1-unit increments.
The Stall Prevention level during acceleration setting is too low.	<p>Increase the value set in <i>L3-02</i> [<i>Stall Prevent Level during Accel</i>].</p> <p><b>Note:</b> If the <i>L3-02</i> value is too low, the acceleration time can be unsatisfactorily long.</p>
The Stall Prevention level during run setting is too low.	<p>Increase the value set in <i>L3-06</i> [<i>Stall Prevent Level during Run</i>].</p> <p><b>Note:</b> If the <i>L3-06</i> value is too low, speed will decrease while the drive outputs torque.</p>
Drive reached the limitations of the V/f motor control method.	<ul style="list-style-type: none"> <li>When the motor cable is longer than 50 m (164 ft.), do Auto-Tuning for line-to-line resistance.</li> <li>Set the V/f pattern to "High Starting Torque".</li> <li>Use a Vector Control method.</li> </ul> <p><b>Note:</b> V/f control method does not provide high torque at low speeds.</p>



### ◆ The Drive Frequency Reference Is Different than the Controller Frequency Reference Command

Causes	Possible Solutions
The analog input gain and bias for the frequency reference input are set incorrectly.	Examine the gain and bias settings for the analog inputs that set the frequency reference. <ul style="list-style-type: none"> <li>Terminal A1: H3-03 [Terminal A1 Gain Setting], H3-04 [Terminal A1 Bias Setting]</li> <li>Terminal A2: H3-11 [Terminal A2 Gain Setting], H3-12 [Terminal A2 Bias Setting]</li> <li>Terminal A3: H3-07 [Terminal A3 Gain Setting], H3-08 [Terminal A3 Bias Setting]</li> </ul>
The drive is receiving frequency bias signals from analog input terminals A1 to A3 and the sum of all signals makes the frequency reference.	<ul style="list-style-type: none"> <li>Examine parameters H3-02, H3-10, H3-06 [MFAI Function Select]. If two or more of these parameters are set to 0, change the settings.</li> <li>Use U1-13 to U1-15 [Terminal A1, A2, A3 Input Voltage] to make sure that the analog input values set to terminals A1, A2, and A3 are applicable.</li> </ul>
Examine the gain and bias settings for the analog inputs that set the frequency reference.	Reduce the value set in n4-70 [Speed Command Comp @ Low Freq].
PID control is enabled.	<p>If PID control is not necessary, set b5-01 = 0 [PID Mode Setting = Disabled].</p> <p><b>Note:</b> When PID control is enabled, the drive adjusts the output frequency as specified by the target value. The drive will only accelerate to the maximum output frequency set in E1-04 [Maximum Output Frequency] while PID control is active.</p>

### ◆ The Motor Speed Is Not Stable When Using a PM Motor

Causes	Possible Solutions
E5-01 [PM Motor Code Selection] is set incorrectly.	Refer to "Motor Performance Fine-Tuning" in the technical manual.
The drive is operating the motor at more than the specified speed control range.	Examine the speed control range and adjust the speed.
The motor is operating at a speed reference of 5% or lower.	Use a different drive to operate a motor at a speed reference of 5% or lower. Contact Yaskawa or your nearest sales representative.
The motor is hunting.	Adjust these parameters to have the largest effect: <ul style="list-style-type: none"> <li>n8-55 [Motor to Load Inertia Ratio]</li> <li>n8-45 [Speed Feedback Detection Gain]</li> <li>C4-02 [Torque Compensation Delay Time]</li> </ul>
Hunting occurs at start.	Increase the value set in C2-01 [S-Curve Time @ Start of Accel].
Too much current is flowing through the drive.	Set E5-01 [PM Motor Code Selection] correctly as specified by the motor. For special-purpose motors, enter the correct value to E5-xx as specified by the motor test report.
Speed response is too slow.	Increases the setting value of n8-11 [Observer Calculation Gain 2] in 10-unit increments.

### ◆ There Is Too Much Motor Oscillation and the Rotation Is Irregular

Causes	Possible Solutions
Unsatisfactory balance of motor phases.	<ul style="list-style-type: none"> <li>Make sure that the drive input power voltage supplies stable power.</li> <li>Set L8-05 = 0 [Input Phase Loss Protect Select = Disabled].</li> </ul>
The hunting prevention function is disabled.	<ul style="list-style-type: none"> <li>Set n1-01 = 1 [Hunting Prevention Selection = Enabled].</li> <li>Increase the value of n2-01 [SpdFeedbackDetectCtr (AFR) Gain] or n2-02 [SpdFeedbackDetCtr (AFR) TimeConst1].</li> </ul>

### ◆ Deceleration Takes Longer Than Expected When Dynamic Braking Is Enabled

Causes	Possible Solutions
The stall prevention during deceleration setting is incorrect.	<ul style="list-style-type: none"> <li>Examine the setting for <i>L3-04 [Decel Stall Prevention Selection]</i>.</li> <li>When the drive has a dynamic braking option installed, set <i>L3-04 = 0 [Disabled]</i>.</li> <li>If the drive detects <i>ov [Overvoltage]</i>, set <i>L3-04 = 3 [General Purpose w/ DB resistor]</i>.</li> </ul>
The deceleration time setting is too long.	Set <i>C1-02, C1-04, C1-06, or C1-08 [Deceleration Times]</i> to applicable values.
The motor torque is not sufficient.	<p>Use a larger motor.</p> <p><b>Note:</b> If these items are correct, the demand on the motor is more than the motor capacity:</p> <ul style="list-style-type: none"> <li>Parameter settings are correct.</li> <li>The drive does not detect <i>ov [Overvoltage]</i>.</li> </ul>
The drive and motor system reached the torque limit.	<ul style="list-style-type: none"> <li>Examine the values set in <i>L7-01 to L7-04 [Torque Limit]</i> and increase them if necessary.</li> </ul> <p><b>Note:</b> If the torque limit is enabled, deceleration time can increase because the drive cannot output more torque than the limit.</p> <ul style="list-style-type: none"> <li>If <i>H3-02, H3-10, H3-06 = 10, 11, 12, 15 [MFAI Function Select = Torque Limit]</i> has been set, examine the settings for the MFAIs. <ul style="list-style-type: none"> <li>Examine the values set in <i>H3-02, H3-10, and H3-06</i>.</li> <li>Use <i>U1-13 to U1-15 [Terminal A1, A2, A3 Input Voltage]</i> to make sure that the analog input values set to terminals A1, A2, and A3 are applicable.</li> </ul> </li> </ul>
The load is more than the internal torque limit as specified by the drive rated current.	Replace the drive with a larger capacity model.

### ◆ The Load Falls When a Brake Is Applied

Causes	Possible Solutions
The open/close timing of the brake is incorrect.	Refer to "Notes on Controlling the Brake when Using the Hoist Application Preset" in the technical manual and take appropriate measures.
The DC injection braking is not sufficient.	Increase the value set in <i>b2-02 [DC Injection Braking Current]</i> .

### ◆ There Is Audible Noise from the Drive or Motor Cables When the Drive Is Energized

Causes	Possible Solutions
The relay switching in the drive is making too much noise.	<ul style="list-style-type: none"> <li>Use <i>C6-02 [Carrier Frequency Selection]</i> to decrease the carrier frequency.</li> <li>Connect a noise filter to the input side of the drive power supply.</li> <li>Connect a noise filter to the output side of the drive.</li> <li>Isolate the control circuit wiring from the main circuit wiring.</li> <li>Use a metal cable gland to wire the drive.</li> <li>Shield the periphery of the drive with metal.</li> <li>Make sure that the drive and motor are grounded correctly.</li> <li>Make sure that ground faults have not occurred in the wiring or motor.</li> </ul>

### ◆ Residual Current Monitoring/Detection (RCM/RCD) Trips During Run

Causes	Possible Solutions
There is too much leakage current from the drive.	<ul style="list-style-type: none"> <li>• Increase the RCM/RCD sensitivity or use RCM/RCD with a higher threshold.</li> <li>• Use C6-02 [Carrier Frequency Selection] to decrease the carrier frequency.</li> <li>• Decrease the length of the cable used between the drive and the motor.</li> <li>• Install a noise filter or AC reactor on the output side of the drive. Set C6-02 = 1 [2.0 kHz] when connecting an AC reactor.</li> <li>• Disable the internal EMC filter.</li> </ul>

### ◆ Motor Rotation Causes Unexpected Audible Noise from Connected Machinery

Causes	Possible Solutions
The carrier frequency and the resonant frequency of the connected machinery are the same.	<ul style="list-style-type: none"> <li>• Adjust C6-02 to C6-05 [Carrier Frequency].</li> <li>• Set C6-02 = 1 to 6 [Carrier Frequency Selection = Frequency other than Swing PWM].</li> </ul> <p><b>Note:</b> If C6-02 = 7 to A [Carrier Frequency Selection = Swing PWM], the drive will not know if the noise comes from the drive or the machine.</p>
The drive output frequency and the resonant frequency of the connected machinery are the same.	<ul style="list-style-type: none"> <li>• Adjust d3-01 to d3-04 [Jump Frequency].</li> <li>• Put the motor on a rubber pad to decrease vibration.</li> </ul>

### ◆ Motor Rotation Causes Oscillation or Hunting

Causes	Possible Solutions
The frequency reference is assigned to an external source, and there is electrical interference in the signal.	<p>Make sure that electrical interference does not have an effect on the signal lines.</p> <ul style="list-style-type: none"> <li>• Isolate control circuit wiring from main circuit wiring.</li> <li>• Use twisted-pair cables or shielded wiring for the control circuit.</li> <li>• Increase the value of H3-13 [Analog Input Filter Time Constant].</li> </ul>
The cable between the drive and motor is too long.	<ul style="list-style-type: none"> <li>• Do Auto-Tuning.</li> <li>• Make the wiring as short as possible.</li> </ul>
The PID parameters are not sufficiently adjusted.	Adjust b5-xx [PID control].

### ◆ PID Output Fault

Causes	Possible Solutions
There is no PID feedback input.	<ul style="list-style-type: none"> <li>• Examine the MFAI terminal settings.</li> <li>• See if H3-02, H3-10, H3-06 = B [MFAI Function Select = PID Feedback] is set.</li> <li>• Make sure that the MFAI terminal settings agree with the signal inputs.</li> <li>• Examine the connection of the feedback signal.</li> <li>• Make sure that b5-xx [PID Control] is set correctly.</li> </ul> <p><b>Note:</b> If there is no PID feedback input to the terminal, the detected value is 0, which causes a PID fault and also causes the drive to operate at maximum frequency.</p>
The detection level and the target value do not agree.	<p>Use H3-03, H3-11, H3-07 [Terminal A1, A2, A3 Gain Setting] to adjust PID target and feedback signal scaling.</p> <p><b>Note:</b> PID control keeps the difference between the target value and detection value at 0. Set the input level for the values relative to each other.</p>
Reverse drive output frequency and speed detection. When output frequency increases, the sensor detects a speed decrease.	Set b5-09 = 1 [PID Output Level Selection = Reverse output (reverse acting)].

### ◆ The Starting Torque Is Not Sufficient

Causes	Possible Solutions
Auto-Tuning has not been done in vector control method.	Do Auto-Tuning.
The control method was changed after doing Auto-Tuning.	Do Auto-Tuning again.
Stationary Auto-Tuning for Line-to-Line Resistance was done.	Do Rotational Auto-Tuning.

### ◆ The Motor Rotates after the Drive Output Is Shut Off

Causes	Possible Solutions
DC Injection Braking is too low and the drive cannot decelerate correctly.	<ul style="list-style-type: none"> <li>• Increase the value set in <i>b2-02</i> [DC Injection Braking Current].</li> <li>• Increase the value set in <i>b2-04</i> [DC Inject Braking Time at Stop].</li> </ul>
The stopping method makes the drive coast to stop.	Set <i>b1-03</i> = 0 or 2 [Stopping Method Selection = Ramp to Stop, DC Injection Braking to Stop].

### ◆ The Output Frequency Is Lower Than the Frequency Reference

Causes	Possible Solutions
The frequency reference is in the Jump frequency range.	Adjust <i>d3-01</i> to <i>d3-03</i> [Jump Frequency 1 to 3] and <i>d3-04</i> [Jump Frequency Width]. <b>Note:</b> Enabling the Jump frequency prevents the drive from outputting the frequencies specified in the Jump range.
The upper limit for the frequency reference has been exceeded.	Set <i>E1-04</i> [Maximum Output Frequency] and <i>d2-01</i> [Frequency Reference Upper Limit] to the best values for the application. <b>Note:</b> This calculation supplies the upper value for the output frequency: $E1-04 \times d2-01 / 100$
A large load triggered Stall Prevention function during acceleration.	<ul style="list-style-type: none"> <li>• Decrease the load.</li> <li>• Adjust <i>L3-02</i> [Stall Prevent Level during Accel].</li> </ul>
<i>L3-01</i> = 3 [Stall Prevent Select during Accel = ILim Mode] has been set.	<ol style="list-style-type: none"> <li>1. Check whether the V/f pattern and motor parameter settings are appropriate, and set them correctly.</li> <li>2. If this does not solve the problem, and it is not necessary to limit the current level of stall during acceleration, adjust <i>L3-02</i>.</li> <li>3. If this does not solve the problem, set <i>L3-01</i> = 1 [Enabled].</li> </ol>
The motor is rotating at this speed: $b2-01$ [DC Injection/Zero SpeedThreshold] $\leq$ Motor Speed $<$ <i>E1-09</i> [Minimum Output Frequency]	<ul style="list-style-type: none"> <li>• Set <i>b1-21</i> = 1 [CLV Start Selection = Accept Run command at any speed].</li> <li>• Set <i>E1-09</i> <math>&lt;</math> <i>b2-01</i>.</li> </ul>

### ◆ The Motor Is Making an Audible Noise

Causes	Possible Solutions
100% of the rated output current of the drive was exceeded while operating at low speeds.	<ul style="list-style-type: none"> <li>• If the sound is coming from the motor, set <i>L8-38</i> = 0 [Carrier Frequency Reduction = Disabled].</li> <li>• If <i>oL2</i> [Drive Overloaded] occurs frequently after setting <i>L8-38</i> = 0, replace the drive with a high-capacity drive.</li> </ul>

### ◆ The Motor Will Not Restart after a Loss of Power

Causes	Possible Solutions
The drive did not receive a Run command after applying power.	<ul style="list-style-type: none"> <li>• Examine the sequence and wiring that enters the Run command.</li> <li>• Set up a relay to make sure that the Run command stays enabled during a loss of power.</li> </ul>
For applications that use 3-wire sequence, the momentary power loss continued for a long time, and the relay that keeps the Run command has been switched off.	Examine the wiring and circuitry for the relay that keeps the Run command enabled during the momentary power loss ride-thru time.

# Periodic Inspection and Maintenance

---

This chapter gives information about how to examine and maintain drives in use, how to replace cooling fans and other parts, and how to store drives.

<b>7.1</b>	<b>Section Safety .....</b>	<b>398</b>
<b>7.2</b>	<b>Inspection.....</b>	<b>400</b>
<b>7.3</b>	<b>Maintenance .....</b>	<b>403</b>
<b>7.4</b>	<b>Replace a Cooling Fan and Circulation Fan .....</b>	<b>405</b>
<b>7.5</b>	<b>Replace the Drive .....</b>	<b>431</b>
<b>7.6</b>	<b>Replace the Keypad Battery .....</b>	<b>437</b>
<b>7.7</b>	<b>Storage Guidelines .....</b>	<b>438</b>

## 7.1 Section Safety

### DANGER

#### Electrical Shock Hazard

**Do not examine, connect, or disconnect wiring on an energized drive. Before servicing, disconnect all power to the equipment and wait for the time specified on the warning label at a minimum. The internal capacitor stays charged after the drive is de-energized. The charge indicator LED extinguishes when the DC bus voltage decreases below 50 Vdc. When all indicators are OFF, remove the covers before measuring for dangerous voltages to make sure that the drive is safe.**

Failure to obey will cause death or serious injury.

**While the drive is ON, never attempt to change any wiring, disconnect any option cards or connectors, or replace the cooling fan. Before performing any repairs, shut OFF the power supply to the drive and verify that there is no residual voltage in the unit.**

Failure to do so may result in serious electric shock.

**A motor will continue to run even when the power supply to the drive has been turned OFF. PM motors generate induced voltage to the terminal of the motor even when the power supply to the drive has been switched OFF.**

Failure to comply could result in death or serious injury.

### WARNING

#### Electrical Shock Hazard

**Do not operate equipment when covers are missing. Some figures in this section include drives without covers or safety shields to more clearly show the inside of the drive. Replace covers and shields before operation. Use drives only as specified by the instructions.**

Failure to obey can cause death or serious injury.

**Always ground the motor-side grounding terminal.**

Contacting the motor case can cause death or serious injury from incorrect equipment grounding.

**Only let authorized persons install, wire, maintain, examine, replace parts, and repair the drive.**

Failure to obey can cause death or serious injury.

**Do not work on the drive or around the drive while wearing loose clothing or jewelry. Tighten loose clothing and remove all metal objects such as watches or rings.**

Failure to obey can cause death or serious injury.

#### Fire Hazard

**Tighten all terminal screws to the correct tightening torque.**

Connections that are too loose or too tight can cause incorrect operation and damage to the drive. Incorrect connections can also cause death or serious injury from fire.

**Do not use the main circuit power supply (Overcurrent Category III) at incorrect voltages. Make sure that the drive rated voltage aligns with the power supply voltage before energizing the drive.**

Failure to obey can cause death or serious injury.

**Do not put flammable or combustible materials on top of the drive and do not install the drive near flammable or combustible materials. Attach the drive to metal or other noncombustible material.**

Failure to obey can cause death or serious injury.

### CAUTION

#### Burn Hazard

**Do not touch a hot drive heatsink. De-energize the drive, wait 15 minutes minimum, and make sure that the heatsink is cool to replace the cooling fans.**

Failure to obey can cause minor to moderate injury.

**NOTICE****Observe correct electrostatic discharge (ESD) procedures when touching the drive.**

Failure to obey can cause ESD damage to the drive circuitry.

**Follow cooling fan replacement instructions. Replace all fans when performing maintenance to help ensure maximum useful product life.**

Improper fan replacement could cause damage the drive.

**Do not use unshielded wire for control wiring. Use shielded twisted-pair wires and ground the shield to the ground terminal of the drive.**

Failure to comply may cause electrical interference resulting in poor system performance.

**Do not change the drive circuitry.**

Failure to obey can cause damage to the drive and will void warranty. Yaskawa is not responsible for modifications of the product made by the user.

**Make sure that all connections are correct after you install the drive and connecting peripheral devices.**

Failure to obey can cause damage to the drive.

**Comply with proper wiring practices. Connect motor input terminals U, V and W to drive output terminals U/T1, V/T2, and W/T3. The phase order for the drive and motor should match.**

The motor may run in reverse if the phase order is backward.

**Turn the drive ON (Run) and OFF (Stop) a maximum of one time each 30 minutes with the MC on the power source side to extend the service life of the relay contacts and electrolytic capacitors in the drive. Run and Stop the motor as much as possible with the drive.**

The drive can fail if users frequently turn the drive ON and OFF with the MC on the power source side to Run and Stop the drive. Incorrect operation can decrease the service life of the relay contacts and electrolytic capacitors.

**Do not connect or operate damaged equipment or equipment with missing parts.**

Failure to obey can cause damage to the drive and connected equipment.

## 7.2 Inspection

Power electronics have limited life and can show changes in performance and deterioration of performance after years of use in usual conditions. To help prevent these problems, it is important to do preventive maintenance and regular inspection, and replace parts on the drive.

Drives contain different types of power electronics, for example power transistors, semiconductors, capacitors, resistors, fans, and relays. The electronics in the drive are necessary for correct motor control.

Follow the inspection lists in this chapter as a part of a regular maintenance program.

**Note:**

Examine the drive one time each year at a minimum.

The operating conditions, environmental conditions, and use conditions will have an effect on the examination frequency for connected equipment.

Examine the drive more frequently if you use the drive in bad conditions or in these conditions:

- High ambient temperatures
- Frequent starting and stopping
- Changes in the AC power supply or load
- Too much vibration or shock loading
- Dust, metal dust, salt, sulfuric acid, or chlorine atmospheres
- Unsatisfactory storage conditions.

### ◆ Recommended Daily Inspection

Table 7.1 gives information about the recommended daily inspection for Yaskawa drives. Examine the items in Table 7.1 each day to make sure that the components do not wear out or fail. Make a copy of this checklist and put a check mark in the “Checked” column after each inspection.

**Table 7.1 Daily Inspection Checklist**

Inspection Area	Inspection Points	Corrective Action	Checked
Motor	Examine for unusual oscillation or noise coming from the motor.	<ul style="list-style-type: none"> <li>• Check the load coupling.</li> <li>• Measure motor vibration.</li> <li>• Tighten all loose components.</li> </ul>	
Cooling System	Examine for unusual heat from the drive or motor and visible discoloration.	<ul style="list-style-type: none"> <li>• Check for a load that is too heavy.</li> <li>• Tighten loose screws.</li> <li>• Check for a dirty heatsink or motor.</li> <li>• Check the ambient temperature.</li> </ul>	
	Examine the cooling fans, circulation fans, and circuit board cooling fans.	<ul style="list-style-type: none"> <li>• Check for a clogged or dirty fan.</li> <li>• Use the performance life monitor to check for correct fan operation.</li> </ul>	
Surrounding Environment	Make sure that the installation environment is applicable.	Remove the source of contamination or correct unsatisfactory environment.	
Load	Make sure that the drive output current is not more than the motor or drive rating for an extended period of time.	<ul style="list-style-type: none"> <li>• Check for a load that is too heavy.</li> <li>• Check the correct motor parameter settings.</li> </ul>	
Power Supply Voltage	Examine main power supply and control voltages.	<ul style="list-style-type: none"> <li>• Correct the voltage or power supply to agree with nameplate specifications.</li> <li>• Verify all main circuit phases.</li> </ul>	

### ◆ Recommended Periodic Inspection

Table 7.2 to Table 7.6 give information about the recommended periodic inspections for Yaskawa drives. Examine the drive one time each year at a minimum. The operating conditions, environmental conditions, and use conditions will have an effect on the examination frequency for connected equipment. You must use your



experience with the application to select the correct inspection frequency for each drive installation. Periodic inspections will help to prevent performance deterioration and product failure. Make a copy of this checklist and put a check mark in the “Checked” column after each inspection.

**DANGER! Electrical Shock Hazard.** Do not examine, connect, or disconnect wiring on an energized drive. Before servicing, disconnect all power to the equipment and wait for the time specified on the warning label at a minimum. The internal capacitor stays charged after the drive is de-energized. The charge indicator LED extinguishes when the DC bus voltage decreases below 50 Vdc. When all indicators are OFF, remove the covers before measuring for dangerous voltages to make sure that the drive is safe. Failure to obey will cause death or serious injury.

**Table 7.2 Main Circuit Periodic Inspection Checklist**

Inspection Area	Inspection Points	Corrective Action	Checked
General	<ul style="list-style-type: none"> <li>Examine equipment for discoloration from too much heat or deterioration.</li> <li>Examine for damaged parts.</li> </ul>	<ul style="list-style-type: none"> <li>Replace damaged components as necessary.</li> <li>The drive does not have many serviceable parts and it could be necessary to replace the drive.</li> </ul>	
	Examine for dirt, unwanted particles, or dust on components.	<ul style="list-style-type: none"> <li>Examine enclosure door seal.</li> <li>Use a vacuum cleaner to remove unwanted particles and dust without touching the components.</li> <li>If you cannot remove unwanted particles and dust with a vacuum cleaner, replace the components.</li> </ul>	
Conductors and Wiring	<ul style="list-style-type: none"> <li>Examine wiring and connections for discoloration or damage. Examine wiring and connections for discoloration from too much heat.</li> <li>Examine wire insulation and shielding for discoloration and wear.</li> </ul>	Repair or replace damaged wiring.	
Terminal Block	Examine terminals for stripped, damaged, or loose connections.	<ul style="list-style-type: none"> <li>Tighten loose screws.</li> <li>Replace damaged screws or terminals.</li> </ul> <p><b>Note:</b> On drive models, 2056, 2070, 4031, and 4038, you cannot replace the hex screws.</p>	
Electromagnetic Contactors and Relays	<ul style="list-style-type: none"> <li>Examine contactors and relays for too much noise during operation.</li> <li>Examine coils for signs of too much heat, such as melted or broken insulation.</li> </ul>	<ul style="list-style-type: none"> <li>Check coil voltage for overvoltage or undervoltage conditions.</li> <li>Replace broken relays, contactors, or circuit boards that you can remove.</li> </ul>	
Dynamic Braking Option	Examine the insulation for discoloration from too much heat.	If there is discoloration in the option, check to make sure that the wiring is not damaged. A small quantity of discoloration is not a problem.	
Electrolytic Capacitor	<ul style="list-style-type: none"> <li>Examine for leaks, discoloration, or cracks.</li> <li>Check if the cap has come off, if there is swelling, or if there are leaks from broken sides.</li> </ul>	The drive does not have many serviceable parts and it could be necessary to replace the drive.	
Diodes, IGBT (Power Transistor)	Examine for dust or other unwanted material collected on the surface.	<ul style="list-style-type: none"> <li>Use a vacuum cleaner to remove unwanted particles and dust without touching the components.</li> <li>If you cannot remove unwanted particles and dust with a vacuum cleaner, replace the components.</li> </ul>	

**Table 7.3 Motor Periodic Inspection Checklist**

Inspection Area	Inspection Points	Corrective Action	Checked
Operation Check	Check for increased vibration or unusual noise.	Stop the motor and contact approved maintenance personnel as necessary.	

**Table 7.4 Control Circuit Periodic Inspection Checklist**

Inspection Area	Inspection Points	Corrective Action	Checked
General	<ul style="list-style-type: none"> <li>Examine terminals for stripped, damaged, or loose connections.</li> <li>Make sure that all terminals have been correctly tightened.</li> </ul>	<ul style="list-style-type: none"> <li>Tighten loose screws.</li> <li>Replace damaged screws or terminals.</li> <li>If terminals are integral to a circuit board, it could be necessary to replace the control board or the drive.</li> </ul>	
Circuit Boards	<ul style="list-style-type: none"> <li>Check for odor, discoloration, or rust.</li> <li>Make sure that all connections are correctly fastened.</li> <li>Make sure that the surface of the circuit board does not have dust or oil mist.</li> </ul>	<ul style="list-style-type: none"> <li>Tighten loose connections.</li> <li>Use a vacuum cleaner to remove unwanted particles and dust without touching the components.</li> <li>If you cannot remove unwanted particles and dust with a vacuum cleaner, replace the components.</li> <li>Do not use solvents to clean the board.</li> <li>The drive does not have many serviceable parts and it could be necessary to replace the drive.</li> </ul>	

**Table 7.5 Cooling System Periodic Inspection Checklist**

Inspection Area	Inspection Points	Corrective Action	Checked
Cooling Fans	<ul style="list-style-type: none"> <li>Check for unusual oscillation or unusual noise.</li> <li>Check for damaged or missing fan blades.</li> </ul>	Clean or replace the fans as necessary.	
Heatsink	<ul style="list-style-type: none"> <li>Examine for dust or other unwanted material collected on the surface.</li> <li>Examine for dirt.</li> </ul>	Use a vacuum cleaner to remove unwanted particles and dust without touching the components.	
Air Duct	Examine air intake, exhaust openings and make sure that there are no unwanted materials on the surface.	Clear blockages and clean air duct as necessary.	

**Table 7.6 Keypad Periodic Inspection Checklist**

Inspection Area	Inspection Points	Corrective Action	Checked
General	<ul style="list-style-type: none"> <li>Make sure that the keypad shows the data correctly.</li> <li>Examine for dust or other unwanted material that collected on components in the area.</li> </ul>	<ul style="list-style-type: none"> <li>If you have problems with the display or the keys, contact Yaskawa or your nearest sales representative.</li> <li>Clean the keypad.</li> </ul>	

## 7.3 Maintenance

The drive Maintenance Monitors keep track of component wear and tell the user when the end of the estimated performance life is approaching. The Maintenance Monitors prevent the need to shut down the full system for unexpected problems. Users can set alarm notifications for the maintenance periods for these drive components:

- Cooling fan
- Electrolytic capacitor
- Soft charge bypass relay
- IGBT

Contact Yaskawa or your nearest sales representative for more information about part replacement.

### ◆ Replaceable Parts

You can replace these parts of the drive:

- Control circuit terminal board
- Cooling fan, circulation fan
- Keypad

If there is a failure in the main circuit, replace the drive.

If the drive is in the warranty period, contact Yaskawa or your nearest sales representative before you replace parts. Yaskawa reserves the right to replace or repair the drive as specified by the Yaskawa warranty policy.

**WARNING!** *Electrical Shock Hazard. Do not examine, connect, or disconnect wiring on an energized drive. Before servicing, disconnect all power to the equipment and wait for the time specified on the warning label at a minimum. The internal capacitor stays charged after the drive is de-energized. The charge indicator LED extinguishes when the DC bus voltage decreases below 50 Vdc. When all indicators are OFF, remove the covers before measuring for dangerous voltages to make sure that the drive is safe. Failure to obey will cause death or serious injury.*

### ◆ Part Replacement Guidelines

Table 7.7 shows the standard replacement period for replacement parts. When you replace these parts, make sure that you use Yaskawa replacement parts for the applicable model and design revision number of your drive.

**Table 7.7 Standard Replacement Period**

Part	Standard Replacement Period
Cooling fan	10 years
Electrolytic Capacitor <sup>*1</sup>	10 years

\*1 If there is damage to parts that you cannot repair or replace, replace the drive.

**NOTICE:** *Estimated performance life based on specific usage conditions. These conditions are provided for the purpose of replacing parts to maintain performance. Some parts may require more frequent replacement due to poor environments or rigorous use. Usage conditions for estimated performance life: Ambient temperature: Yearly average of 40 °C (IP00/Open Type enclosure) Load factor: 80% maximum Operation time: 24 hours a day*

### ◆ Monitors that Display the Lifespan of Drive Components

The drive keypad shows percentage values for the replacement parts to help you know when you must replace those components. Use the monitors in Table 7.8 to check replacement periods. When the monitor value is 100%, the component is at the end of its useful life and there is an increase risk of drive malfunction. Yaskawa recommends that you check the maintenance period regularly to make sure that you get the maximum performance life.

**Table 7.8 Performance Life Monitors**

Monitor No.	Component	Description
U4-03	Cooling fan	Shows the total operation time of fans as 0 to 99999 hours. After this value is 99999, the drive automatically resets it to 0.
U4-04		Shows the total fan operation time as a percentage of the specified maintenance period.
U4-05	Electrolytic capacitor	Shows the total capacitor usage time as a percentage of the specified maintenance period.

## 7.3 Maintenance

Monitor No.	Component	Description
U4-06	Soft charge bypass relay	Shows the number of times the drive is energized as a percentage of the performance life of the inrush circuit.
U4-07	IGBT	Shows the percentage of the maintenance period reached by the IGBTs.

### ◆ Alarm Outputs for Maintenance Monitors

You can use *H2-xx* [*Multi-Function Digital Out*] to send a message that tells you when a specified component is near the end of its performance life estimate. Set the applicable value to *H2-xx* as shown in [Table 7.9](#) for your component.

When the specified component is near the end of its performance life estimate, the MFDO terminals set for *H2-xx* = 2F [*Maintenance Notification*] will turn ON, and the keypad will show an alarm that identifies the component to replace.

**Table 7.9 Maintenance Period Alarms**

Display	Alarm Name	Cause	Solution	MFDO (Setting Value in H2-xx)
LT-1	Cooling Fan Maintenance Time	The cooling fan is at 90% of its performance life estimate.	Replace the cooling fan, then set <i>o4-03</i> = 0 [ <i>Fan Operation Time Setting</i> = 0 h] to reset the cooling fan operation time.	2F
LT-2	Capacitor Maintenance Time	The main circuit and control circuit capacitors are at 90% of their performance life estimate.	Replace the board or the drive. Contact Yaskawa or your nearest sales representative to replace the board.	
LT-3	SoftChargeBy passRelay MainteTime	The soft charge bypass relay is at 90% of its performance life estimate.	Replace the board or the drive. Contact Yaskawa or your nearest sales representative to replace the board.	
LT-4	IGBT Maintenance Time (50%)	The IGBTs are at 50% of their performance life estimate.	Check the load, carrier frequency, and output frequency.	
TrPC	IGBT Maintenance Time (90%)	The IGBTs are at 90% of their performance life estimate.	Replace the IGBTs or the drive.	10

### ◆ Related Parameters

Replace the component, then set *o4-03*, *o4-05*, *o4-07*, and *o4-09* [*Maintenance Setting*] = 0 to reset the Maintenance Monitor. If these parameters are not reset after the corresponding parts have been replaced, the Maintenance Monitor function will continue to count down the performance life from the value that was reached with the old part. If the Maintenance Monitor is not reset, the drive will not have the correct value of the performance life for the new component.

**Note:**

The drive installation environment has an effect on the maintenance period.

**Table 7.10 Maintenance Setting Parameters**

No.	Name	Function
o4-03	Fan Operation Time Setting	Sets the value from which to start the cumulative drive cooling fan operation time in 10-hour units. <b>Note:</b> When <i>o4-03</i> = 30 has been set, the drive will count the operation time for the cooling fan from 300 hours and <i>U4-03</i> [ <i>Cooling Fan Ope Time</i> ] will show 300 h.
o4-05	Capacitor Maintenance Setting	Sets the value from which to start the count for the main circuit capacitor maintenance period as a percentage.
o4-07	Softcharge Relay Maintenance Set	Sets as a percentage the value from which to start the count for the soft charge bypass relay maintenance time.
o4-09	IGBT Maintenance Setting	Sets the value from which to start the count for the IGBT maintenance period as a percentage.

## 7.4 Replace a Cooling Fan and Circulation Fan

**NOTICE:** Follow cooling fan replacement instructions. Replace all fans when performing maintenance to help ensure maximum useful product life. Improper fan replacement could cause damage the drive.

To replace a cooling fan or circulation fan, contact Yaskawa or your nearest sales representative.

### ◆ Cooling Fans and Circulation Fans by Drive Model

Table 7.11 Cooling Fans and Circulation Fans (Three-Phase 200 V)

Model	Cooling Fan	Circulation Fans	Replacement Procedure	Reference
2004 to 2012	-	-	-	-
2018, 2021	1	-	Procedure A	405
2030, 2042	2	-	Procedure B	407
2056	2	-	Procedure C	410
2070 to 2110	2	-	Procedure D	412
2138 to 2313	2	-	Procedure E	414
2360, 2415	3	1	Procedure F	417

Table 7.12 Cooling Fans and Circulation Fans (Three-Phase 400 V)

Model	Cooling Fan	Circulation Fans	Circuit Board Cooling Fans	Replacement Procedure	Reference
4002 to 4005	-	-	-	-	-
4007 to 4012	1	-	-	Procedure A	405
4018, 4023	2	-	-	Procedure B	407
4031, 4038	2	-	-	Procedure C	410
4044 to 4075	2	-	-	Procedure D	412
4089 to 4296	2	-	-	Procedure E	414
4371	2	1	-	Procedure F	417
4389	3	1	-	Procedure F	417
4453 to 4675	2	1	2	Procedure G	423

### ◆ Replace a Fan (Procedure A)

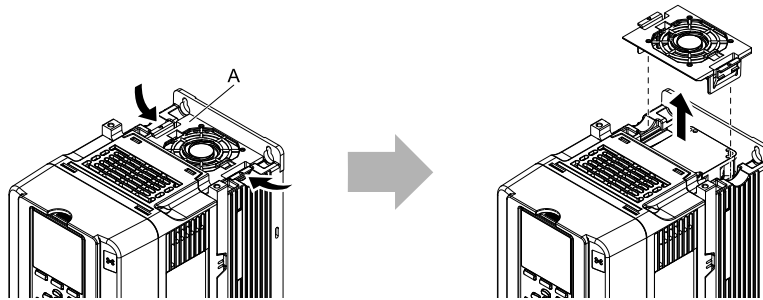
**WARNING! Electrical Shock Hazard.** Do not examine, connect, or disconnect wiring on an energized drive. Before servicing, disconnect all power to the equipment and wait for the time specified on the warning label at a minimum. The internal capacitor stays charged after the drive is de-energized. The charge indicator LED extinguishes when the DC bus voltage decreases below 50 Vdc. When all indicators are OFF, remove the covers before measuring for dangerous voltages to make sure that the drive is safe. Failure to obey will cause death or serious injury.

**CAUTION! Burn Hazard.** Do not touch a hot drive heatsink. De-energize the drive, wait 15 minutes minimum, and make sure that the heatsink is cool to replace the cooling fans. Failure to obey can cause minor to moderate injury.

**NOTICE:** Follow cooling fan replacement instructions. Replace all fans when performing maintenance to help ensure maximum useful product life. Improper fan replacement could cause damage the drive.

### ■ Remove a Fan

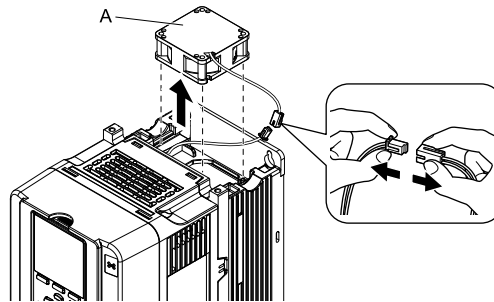
1. To remove the fan finger guard from the drive, push the hooks on the left and right sides of it and pull up.



A - Fan finger guard

Figure 7.1 Remove the Fan Finger Guard

2. Pull the cooling fan straight up from the drive. Disconnect the power supply connector and remove the fan from the drive.



A - Cooling fan

Figure 7.2 Remove the Cooling Fan

### ■ Install a Fan

Reverse the removal procedure to install a cooling fan.

1. Connect the drive and the fan connector.

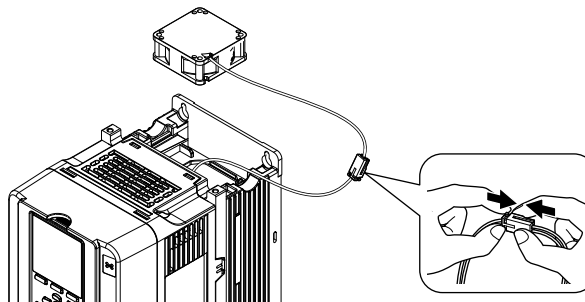
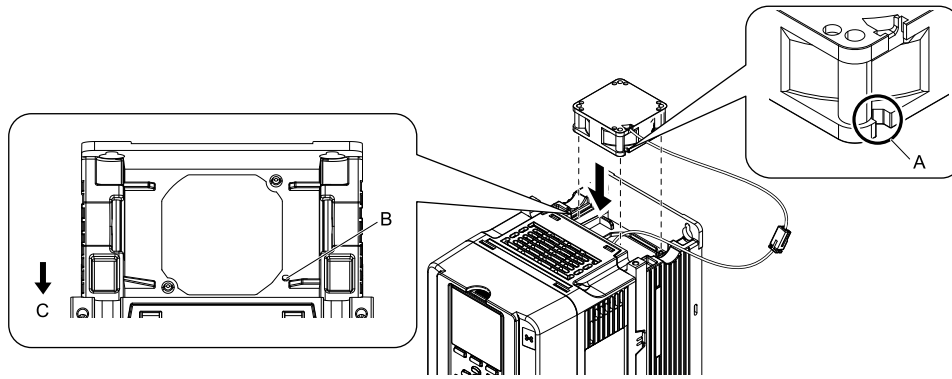


Figure 7.3 Connect Connector

- Align the notches on the fan with the pins on the drive and install the cooling fan in the drive.



A - Notch on fan

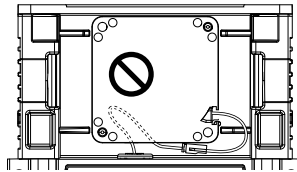
B - Alignment pins on drive

C - Front of drive

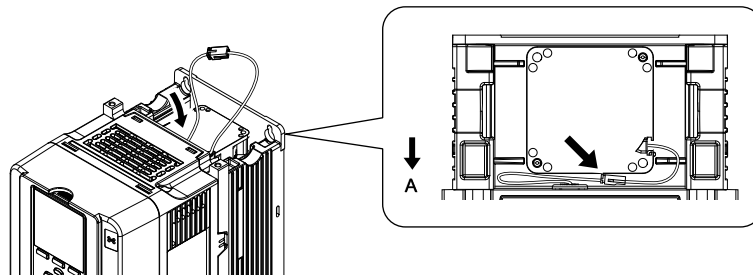
Figure 7.4 Install the Cooling Fan

**Note:**

When you install the cooling fan, make sure that you do not pinch cables between the cooling fan and the drive.



- Put the cable in the recess of the drive.



A - Front of drive

Figure 7.5 Put the Cable in the Drive Recess

- Push the hooks on the left and right sides of the fan finger guard and click it into place on the drive.

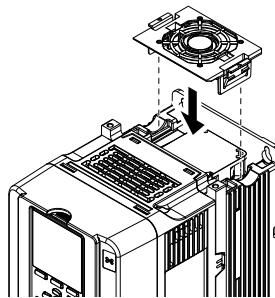


Figure 7.6 Reattach the Fan Finger Guard

- Energize the drive and set  $\alpha 4-03 = 0$  [Fan Operation Time Setting = 0 h] to reset the cooling fan operation time.

## ◆ Replace a Fan (Procedure B)

**WARNING! Electrical Shock Hazard.** Do not examine, connect, or disconnect wiring on an energized drive. Before servicing, disconnect all power to the equipment and wait for the time specified on the warning label at a minimum. The internal capacitor stays charged after the drive is de-energized. The charge indicator LED extinguishes when the DC bus voltage decreases below 50 Vdc. When all indicators are OFF, remove the covers before measuring for dangerous voltages to make sure that the drive is safe. Failure to obey will cause death or serious injury.

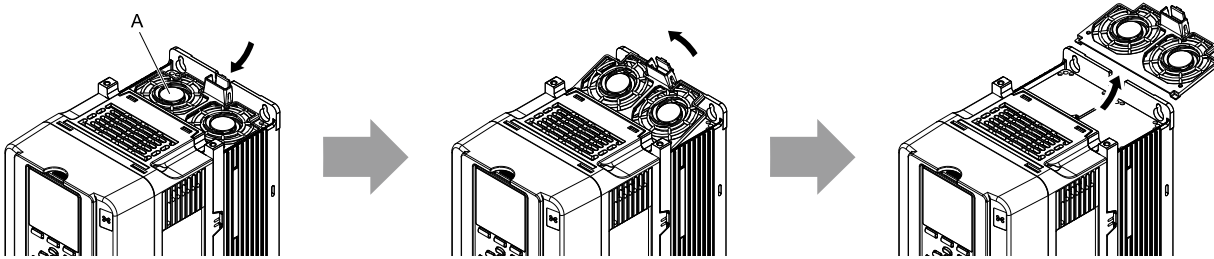
## 7.4 Replace a Cooling Fan and Circulation Fan

**CAUTION!** Burn Hazard. Do not touch a hot drive heatsink. De-energize the drive, wait 15 minutes minimum, and make sure that the heatsink is cool to replace the cooling fans. Failure to obey can cause minor to moderate injury.

**NOTICE:** Follow cooling fan replacement instructions. Replace all fans when performing maintenance to help ensure maximum useful product life. Improper fan replacement could cause damage the drive.

### ■ Remove a Fan

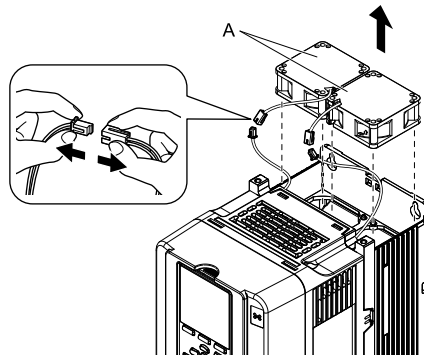
1. To remove the fan finger guard from the drive, push the hook on the back side of the fan finger guard and pull up.



A - Fan finger guard

Figure 7.7 Remove the Fan Finger Guard

2. Pull the cooling fan straight up from the drive. Disconnect the power supply connector and remove the fan from the drive.



A - Cooling Fan

Figure 7.8 Remove the Cooling Fan

### ■ Install a Fan

Reverse the removal procedure to install a cooling fan.

1. Connect the drive and the fan connector.

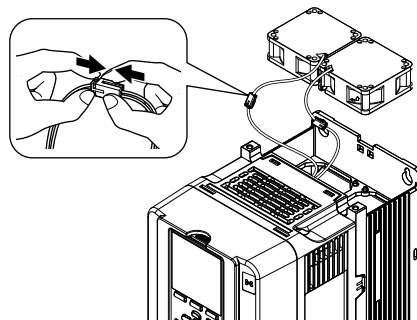
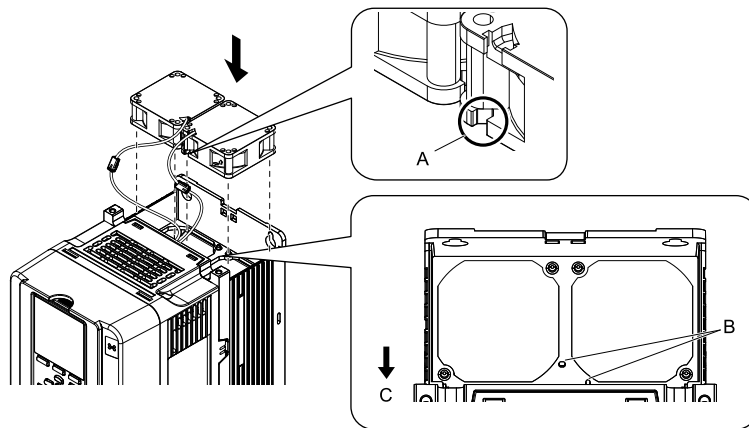


Figure 7.9 Connect the Power Supply Connector



- Align the notches on the fan with the pins on the drive and install the cooling fan in the drive.



A - Notch on fan

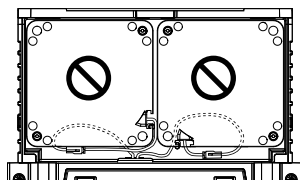
B - Alignment pins on drive

C - Front of drive

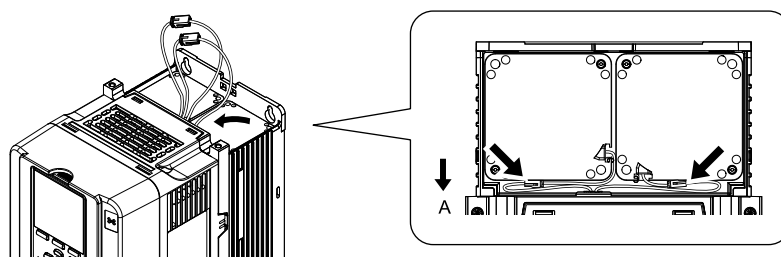
Figure 7.10 Install the Cooling Fan

**Note:**

When you install the cooling fan, make sure that you do not pinch cables between the cooling fan and the drive.



- Put the cable in the recess of the drive.

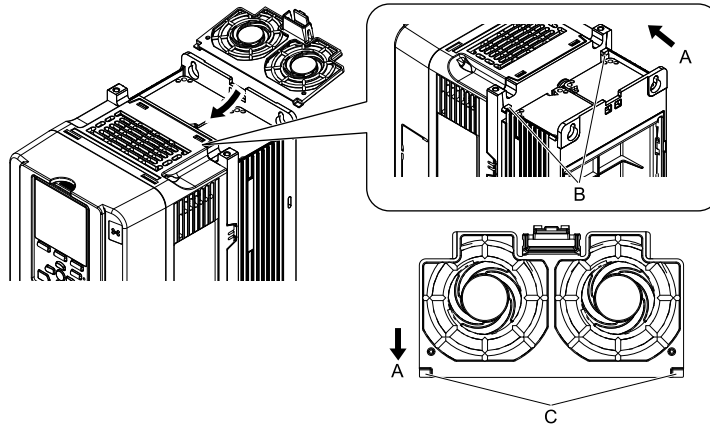


A - Front of drive

Figure 7.11 Put the Cable in the Drive Recess

## 7.4 Replace a Cooling Fan and Circulation Fan

4. Hold the fan finger guard at an angle and put the connector tabs on the fan finger guard into the holes on the drive.



A - Front of drive  
B - Drive holes

C - Connector tabs

Figure 7.12 Reattach the Fan Finger Guard

5. Push the hook on the back side of the fan finger guard and click it into place on the drive.

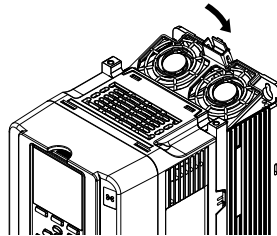


Figure 7.13 Reattach the Fan Finger Guard

6. Energize the drive and set o4-03 = 0 [Fan Operation Time Setting = 0 h] to reset the cooling fan operation time.

### ◆ Replace a Fan (Procedure C)

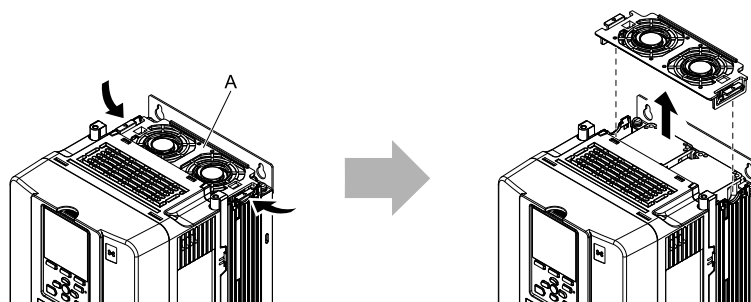
**WARNING!** *Electrical Shock Hazard. Do not examine, connect, or disconnect wiring on an energized drive. Before servicing, disconnect all power to the equipment and wait for the time specified on the warning label at a minimum. The internal capacitor stays charged after the drive is de-energized. The charge indicator LED extinguishes when the DC bus voltage decreases below 50 Vdc. When all indicators are OFF, remove the covers before measuring for dangerous voltages to make sure that the drive is safe. Failure to obey will cause death or serious injury.*

**CAUTION!** *Burn Hazard. Do not touch a hot drive heatsink. De-energize the drive, wait 15 minutes minimum, and make sure that the heatsink is cool to replace the cooling fans. Failure to obey can cause minor to moderate injury.*

**NOTICE:** *Follow cooling fan replacement instructions. Replace all fans when performing maintenance to help ensure maximum useful product life. Improper fan replacement could cause damage the drive.*

### ■ Remove a Fan

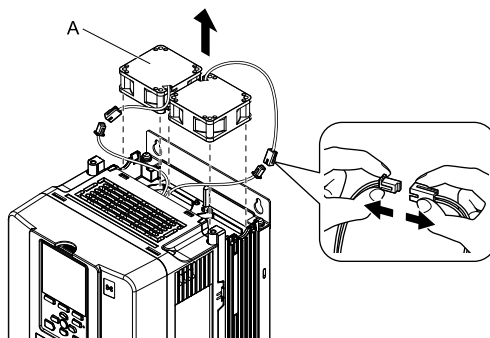
1. To remove the fan finger guard from the drive, push the hooks on the left and right sides of it and pull up.



A - Fan finger guard

Figure 7.14 Remove the Fan Finger Guard

2. Pull the cooling fan straight up from the drive. Disconnect the power supply connector and remove the fan from the drive.



A - Cooling fan

Figure 7.15 Remove the Cooling Fans

■ Install a Fan

Reverse the removal procedure to install a cooling fan.

1. Connect the drive and the fan connector.

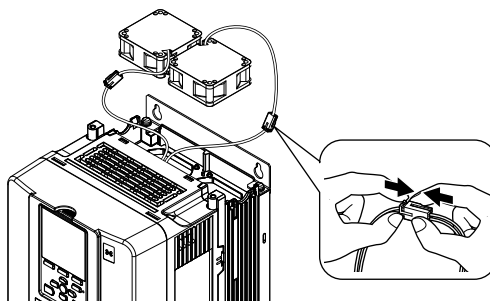
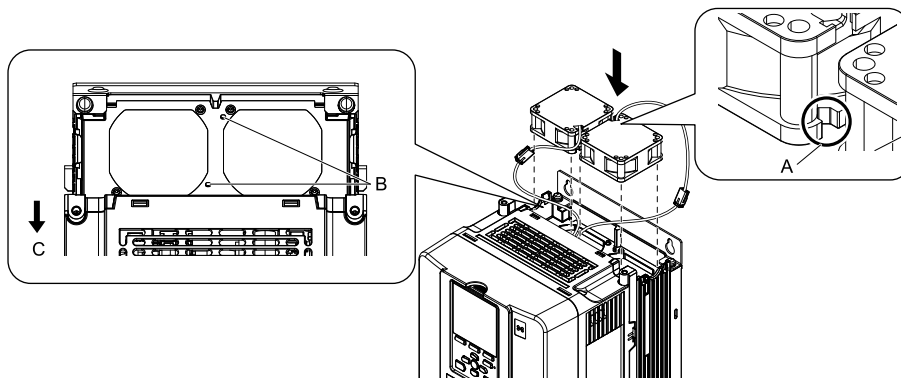


Figure 7.16 Connect the Power Supply Connector

2. Align the notches on the fan with the pin on the drive and install the cooling fan in the drive.



A - Notch on fan

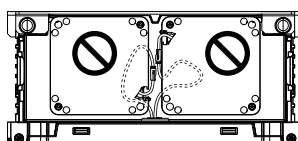
B - Alignment pins on drive

C - Front of drive

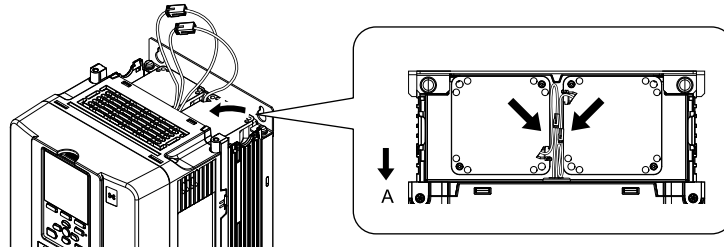
Figure 7.17 Install the Cooling Fan

**Note:**

When you install the cooling fan, make sure that you do not pinch cables between the cooling fan and the drive.



- Put the cable in the recess of the drive.



A - Front of drive

Figure 7.18 Put the Cable in the Drive Recess

- Push the hooks on the left and right sides of the fan finger guard and click it into place on the drive.

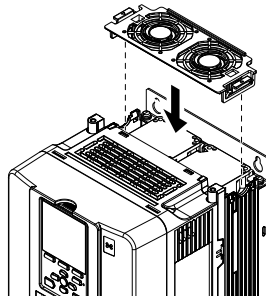


Figure 7.19 Reattach the Fan Finger Guard

- Energize the drive and set o4-03 = 0 [Fan Operation Time Setting = 0 h] to reset the cooling fan operation time.

### ◆ Replace a Fan (Procedure D)

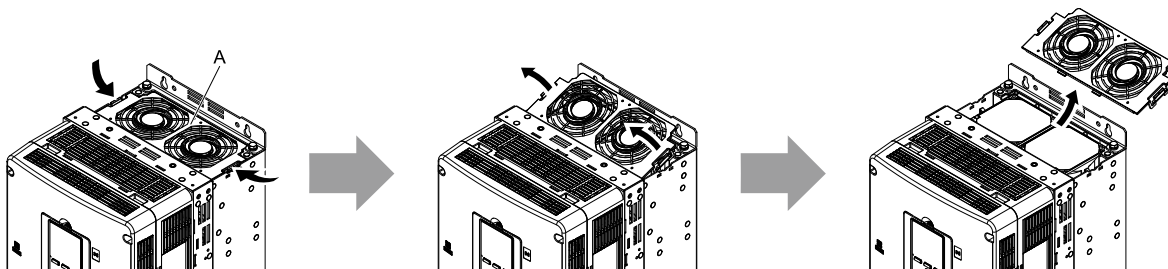
**WARNING! Electrical Shock Hazard.** Do not examine, connect, or disconnect wiring on an energized drive. Before servicing, disconnect all power to the equipment and wait for the time specified on the warning label at a minimum. The internal capacitor stays charged after the drive is de-energized. The charge indicator LED extinguishes when the DC bus voltage decreases below 50 Vdc. When all indicators are OFF, remove the covers before measuring for dangerous voltages to make sure that the drive is safe. Failure to obey will cause death or serious injury.

**CAUTION! Burn Hazard.** Do not touch a hot drive heatsink. De-energize the drive, wait 15 minutes minimum, and make sure that the heatsink is cool to replace the cooling fans. Failure to obey can cause minor to moderate injury.

**NOTICE:** Follow cooling fan replacement instructions. Replace all fans when performing maintenance to help ensure maximum useful product life. Improper fan replacement could cause damage the drive.

### ■ Remove a Fan

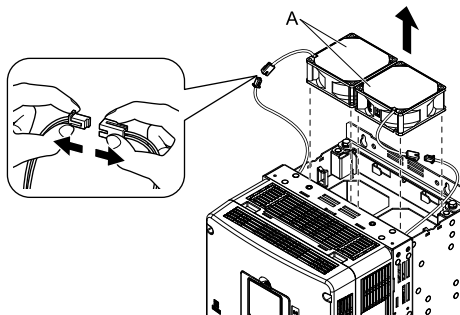
- To remove the fan finger guard from the drive, push the tabs on the left and right sides of it and pull up the back side of the guard.



A - Fan finger guard

Figure 7.20 Remove the Fan Finger Guard

2. Pull the cooling fan straight up from the drive. Disconnect the power supply connector and remove the fan from the drive.



A - Cooling Fan

Figure 7.21 Remove the Cooling Fan

■ Install a Fan

Reverse the removal procedure to install a cooling fan.

1. Connect the drive and the fan connector.

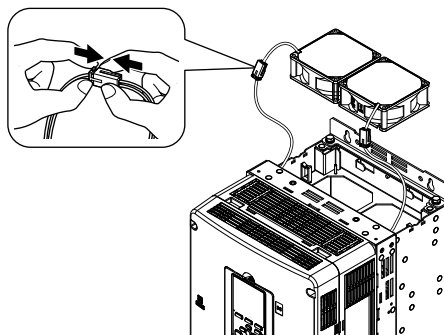
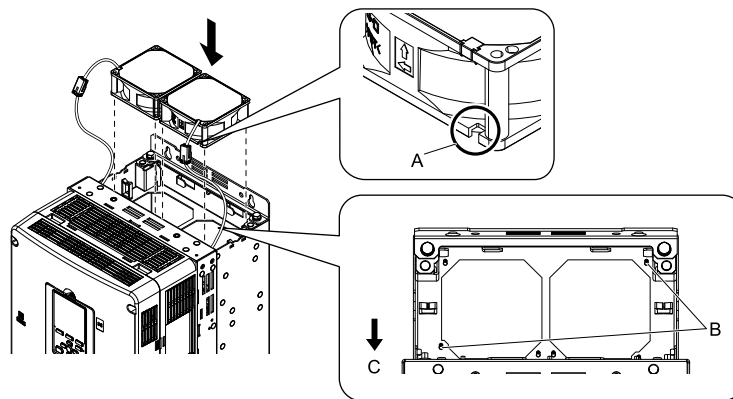


Figure 7.22 Connect Connector

2. Align the notches on the fan with the pins on the drive and install the cooling fan in the drive.



A - Notch on fan

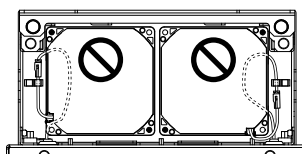
B - Alignment pins on drive

C - Front of drive

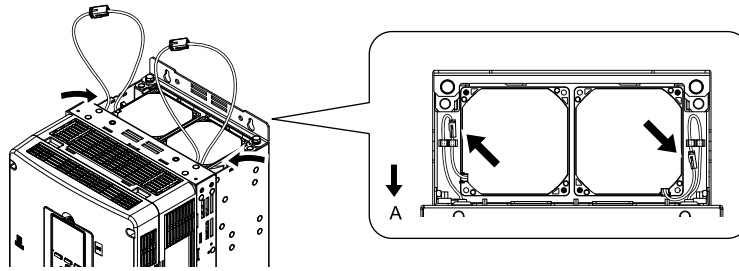
Figure 7.23 Install the Cooling Fan

**Note:**

When you install the cooling fan, make sure that you do not pinch cables between the cooling fan and the drive.



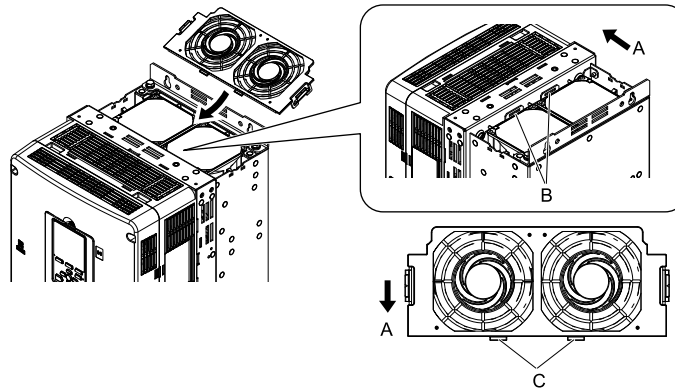
- Put the cable in the recess of the drive.



A - Front of drive

Figure 7.24 Put the Cable in the Drive Recess

- Hold the fan finger guard at an angle and put the connector tabs on the fan finger guard into the holes on the drive.



A - Front of drive  
B - Drive holes

C - Connector tabs

Figure 7.25 Reattach the Fan Finger Guard

- Push the hooks on the left and right sides of the fan finger guard and click it into place on the drive.

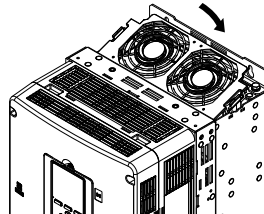


Figure 7.26 Reattach the Fan Finger Guard

- Energize the drive and set  $o4-03 = 0$  [Fan Operation Time Setting = 0 h] to reset the cooling fan operation time.

### ◆ Replace a Fan (Procedure E)

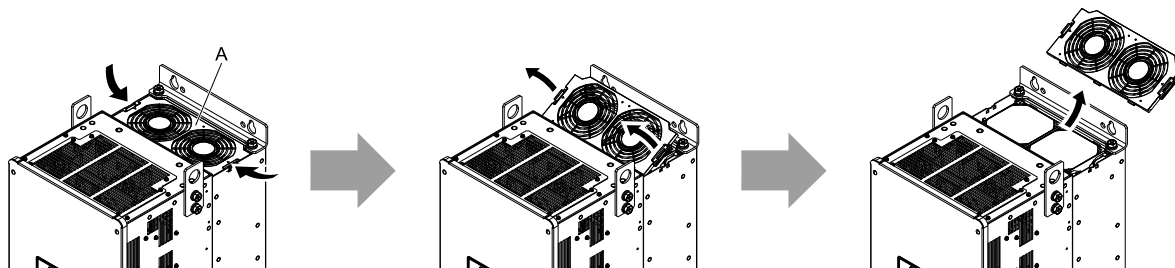
**WARNING! Electrical Shock Hazard.** Do not examine, connect, or disconnect wiring on an energized drive. Before servicing, disconnect all power to the equipment and wait for the time specified on the warning label at a minimum. The internal capacitor stays charged after the drive is de-energized. The charge indicator LED extinguishes when the DC bus voltage decreases below 50 Vdc. When all indicators are OFF, remove the covers before measuring for dangerous voltages to make sure that the drive is safe. Failure to obey will cause death or serious injury.

**CAUTION! Burn Hazard.** Do not touch a hot drive heatsink. De-energize the drive, wait 15 minutes minimum, and make sure that the heatsink is cool to replace the cooling fans. Failure to obey can cause minor to moderate injury.

**NOTICE:** Follow cooling fan replacement instructions. Replace all fans when performing maintenance to help ensure maximum useful product life. Improper fan replacement could cause damage the drive.

### ■ Remove a Fan

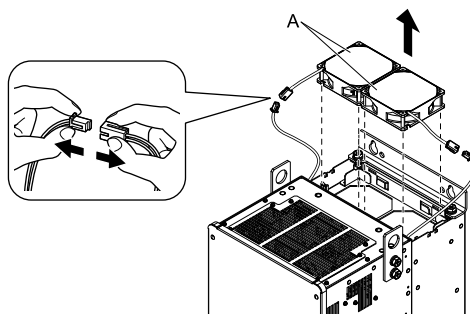
1. To remove the fan finger guard from the drive, push the tabs on the left and right sides of it and pull up the back side of the guard.



A - Fan finger guard

Figure 7.27 Remove the Fan Finger Guard

2. Pull the cooling fan straight up from the drive. Disconnect the power supply connector and remove the fan from the drive.



A - Cooling Fan

Figure 7.28 Remove the Cooling Fan

### ■ Install a Fan

Reverse the removal procedure to install a cooling fan.

1. Connect the drive and the fan connector.

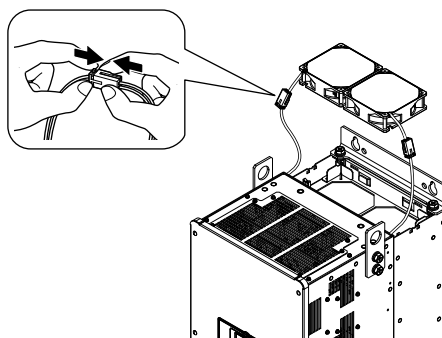
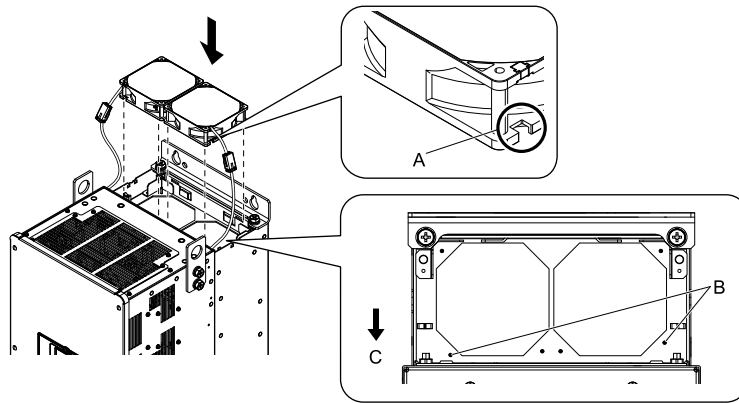


Figure 7.29 Connect Connector

- Align the notches on the fan with the pins on the drive and install the cooling fan in the drive.



A - Notch on fan

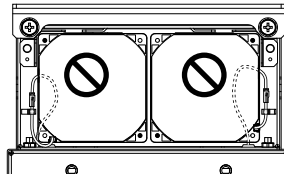
B - Alignment pins on drive

C - Front of drive

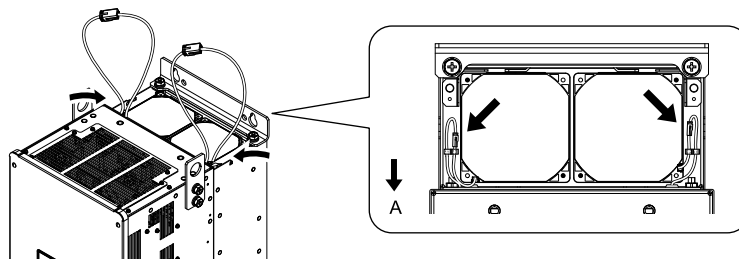
Figure 7.30 Install the Cooling Fan

**Note:**

When you install the cooling fan, make sure that you do not pinch cables between the cooling fan and the drive.



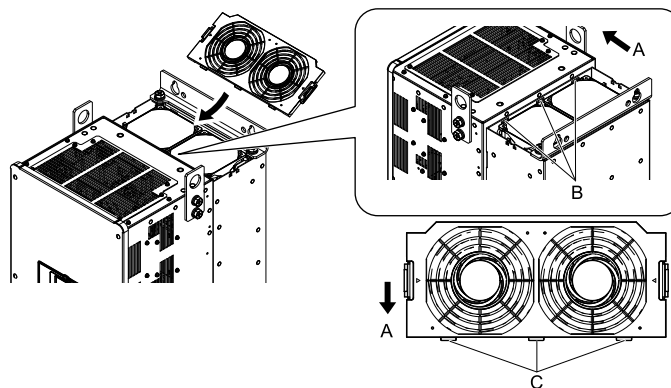
- Put the cable in the recess of the drive.



A - Front of drive

Figure 7.31 Put the Cable in the Drive Recess

- Hold the fan finger guard at an angle and put the connector tabs on the fan finger guard into the holes on the drive.



A - Front of drive

B - Drive holes

C - Connector tabs

Figure 7.32 Reattach the Fan Finger Guard



5. Push the hooks on the left and right sides of the fan finger guard and click it into place on the drive.

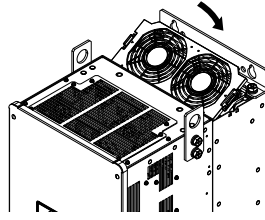


Figure 7.33 Reattach the Fan Finger Guard

6. Energize the drive and set  $\alpha 4-03 = 0$  [Fan Operation Time Setting = 0 h] to reset the cooling fan operation time.

## ◆ Replace Fans (Procedure F)

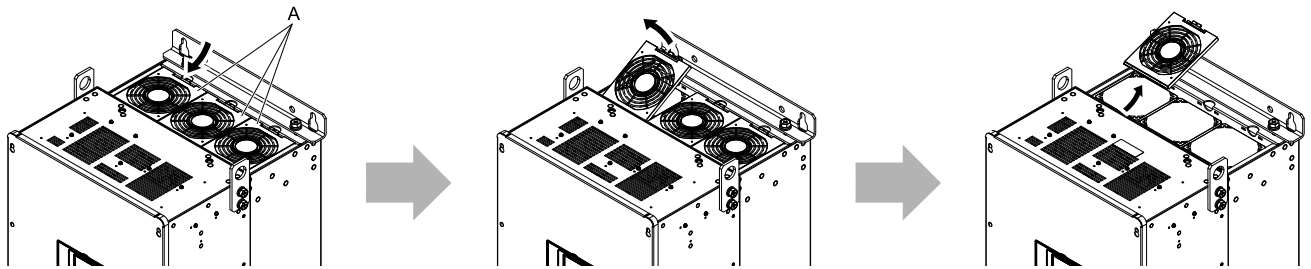
**WARNING! Electrical Shock Hazard.** Do not examine, connect, or disconnect wiring on an energized drive. Before servicing, disconnect all power to the equipment and wait for the time specified on the warning label at a minimum. The internal capacitor stays charged after the drive is de-energized. The charge indicator LED extinguishes when the DC bus voltage decreases below 50 Vdc. When all indicators are OFF, remove the covers before measuring for dangerous voltages to make sure that the drive is safe. Failure to obey will cause death or serious injury.

**CAUTION! Burn Hazard.** Do not touch a hot drive heatsink. De-energize the drive, wait 15 minutes minimum, and make sure that the heatsink is cool to replace the cooling fans. Failure to obey can cause minor to moderate injury.

**NOTICE:** Follow cooling fan replacement instructions. Replace all fans when performing maintenance to help ensure maximum useful product life. Improper fan replacement could cause damage the drive.

### ■ Remove a Fan

1. To remove the fan finger guards from the drive, push the hook on the back side of each guard and pull up.



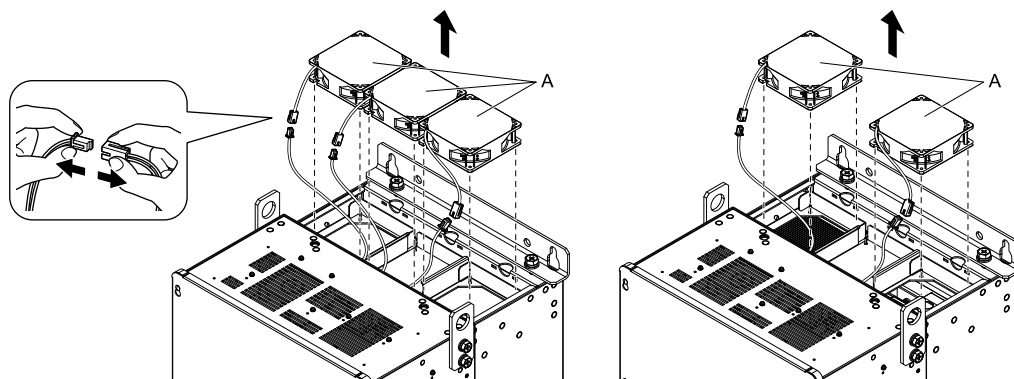
A - Fan finger guard

Figure 7.34 Remove the Fan Finger Guard

2. Pull the cooling fan straight up from the drive. Disconnect the power supply connector and remove the fan from the drive.

#### Note:

The number of fans is different for different drive models.



A - Cooling Fan

Figure 7.35 Remove the Cooling Fan

### ■ Install a Fan

Reverse the removal procedure to install a fan unit.

## 7.4 Replace a Cooling Fan and Circulation Fan

1. Connect the drive and the fan connector.

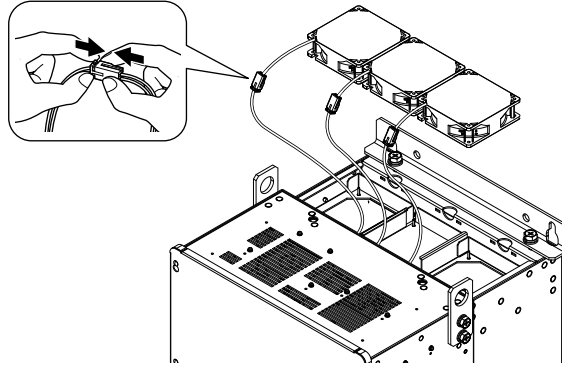
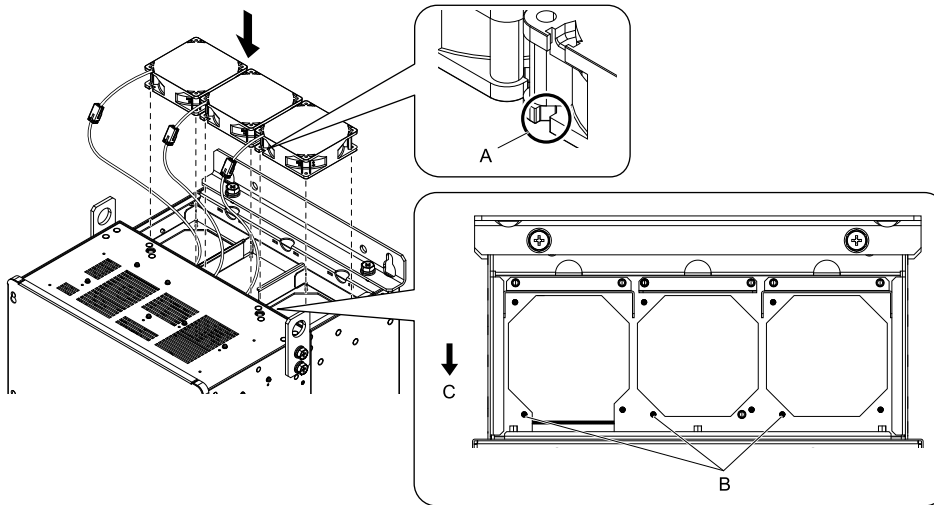


Figure 7.36 Connect Connector

2. Align the notches on the fan with the pins on the drive and install the cooling fan in the drive.



A - Notch on fan

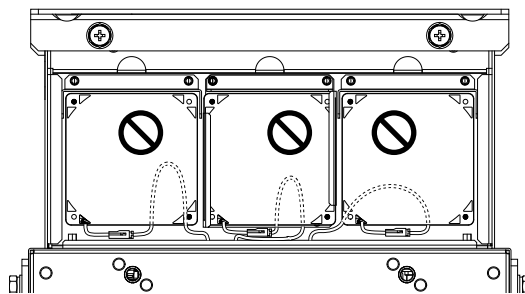
B - Alignment pins on drive

C - Front of drive

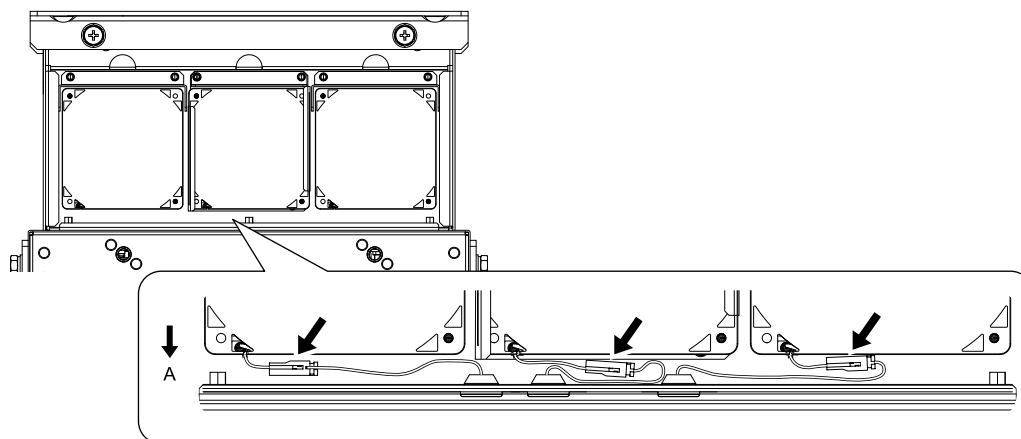
Figure 7.37 Install the Cooling Fan

**Note:**

When you install the cooling fan, make sure that you do not pinch cables between the cooling fan and the drive.



- Put the cable in the recess of the drive.



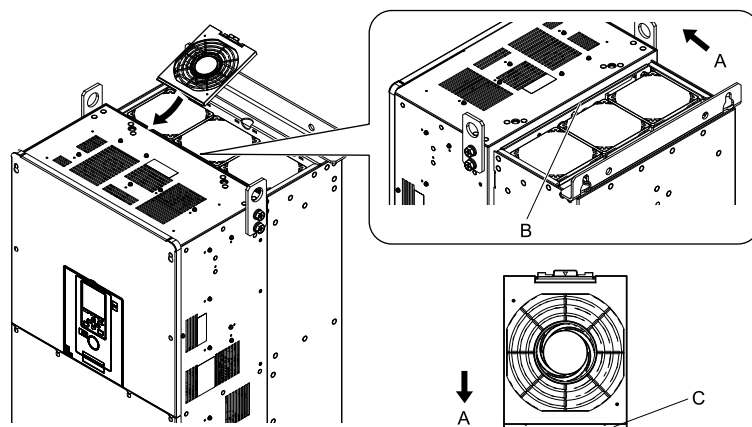
A - Front of drive

Figure 7.38 Put the Cable in the Drive Recess

- Hold the fan finger guard at an angle and put the connector tabs on the fan finger guard into the holes on the drive.

**Note:**

When you install the cooling fan, make sure that you do not pinch cables between the fan finger guard and the drive.



A - Front of drive

B - Insertion area

C - Connector tabs

Figure 7.39 Reattach the Fan Finger Guard

- Push the hook on the back side of the fan finger guard and click it into place on the drive.

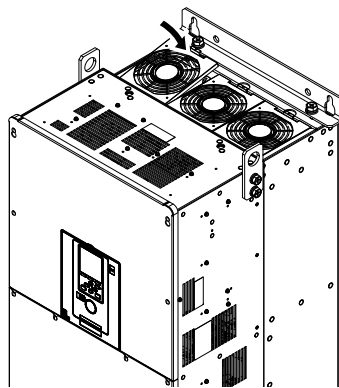


Figure 7.40 Reattach the Fan Finger Guard

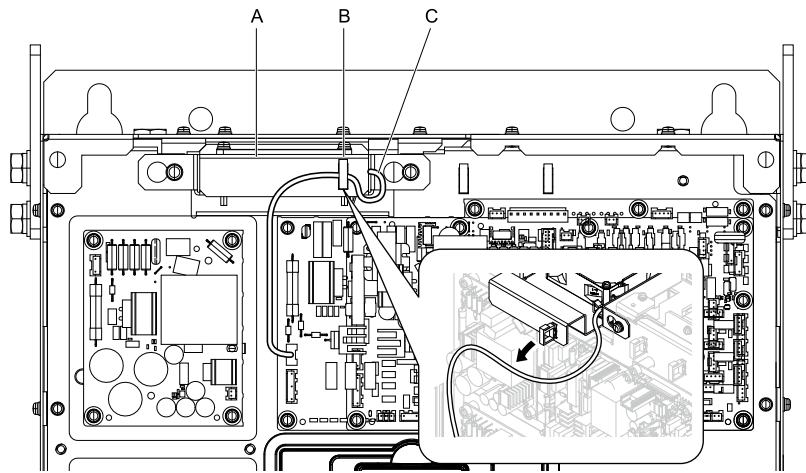
- Energize the drive and set  $o4-03 = 0$  [Fan Operation Time Setting = 0 h] to reset the cooling fan operation time.

### ■ Remove Circulation Fans

Remove the drive cover.

**CAUTION!** *Crush Hazard. Only loosen the cover screws. Do not fully remove the cover screws. Make sure that the covers do not fall. Missing cover screws can cause the cover to fall and cause injury.*

1. Unplug the fan cable from the hook.



A - Fan unit  
B - Hook

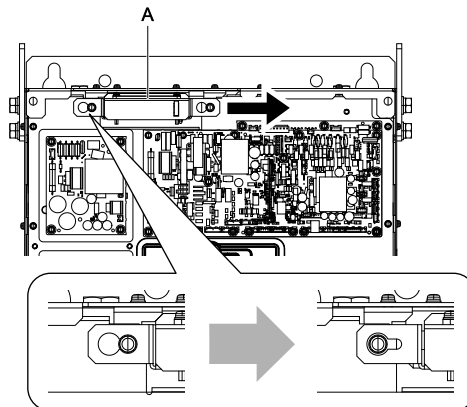
C - Fan cable

**Figure 7.41 Circulation Fan Components**

2. Loosen the fan unit screws and slide the fan unit to the right.

**Note:**

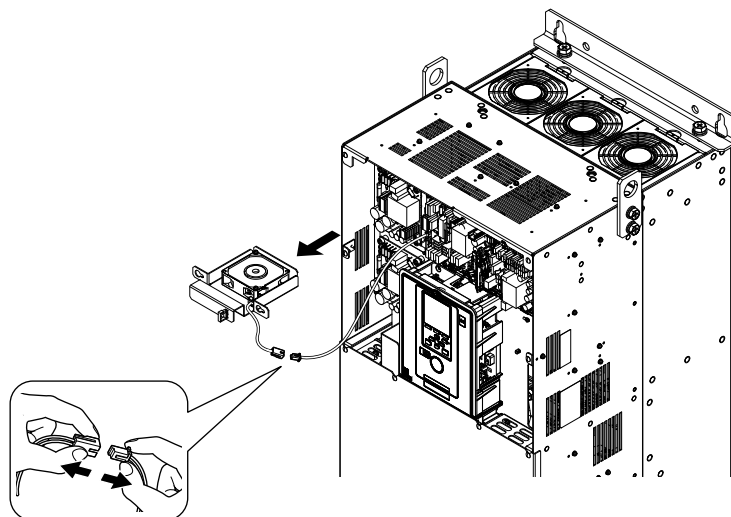
To remove the fan unit, it is only necessary to loosen the screws.



A - Fan unit

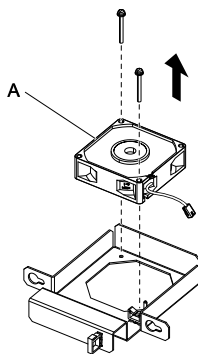
**Figure 7.42 Slide the Fan Unit**

3. Disconnect the relay connector then remove the fan unit.



**Figure 7.43 Remove the Fan Unit**

4. Remove the screws that safety the cooling fan and remove the fan.



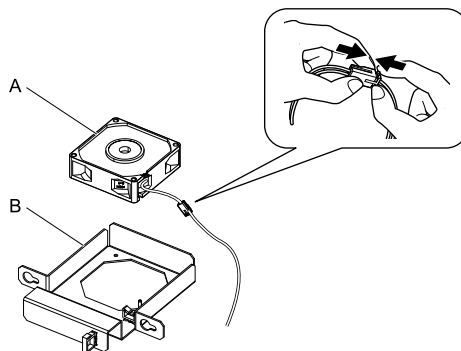
**A - Cooling Fan**

**Figure 7.44 Remove the Cooling Fan**

## ■ Install Circulation Fans

Reverse the removal procedure to install a circulation fan.

1. Connect the drive and the fan connector.



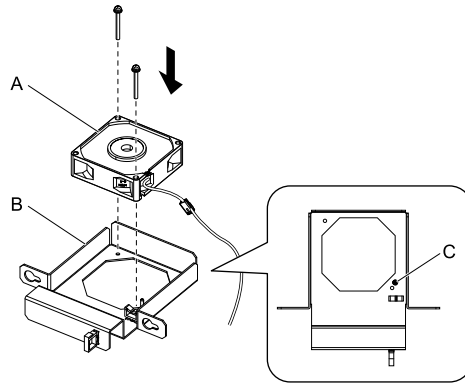
**A - Cooling Fan**

**B - Fan unit base**

**Figure 7.45 Connect Connector**

2. Align the pins on the fan unit base with the notches on the fan, and use the screws to safety. Tighten the M4 screws to a tightening torque of 0.98 N·m to 1.33 N·m (8.67 lb·in. to 11.77 lb·in.).

## 7.4 Replace a Cooling Fan and Circulation Fan



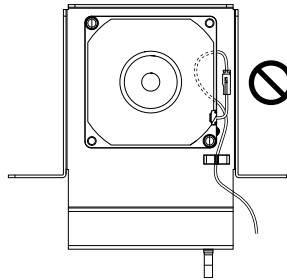
A - Cooling Fan  
B - Fan unit base

C - Alignment pin on fan unit base

Figure 7.46 Install the Cooling Fan

**Note:**

When you install the cooling fan, make sure that you do not pinch cables between the cooling fan and the fan unit base.



- Put the fan unit into the specified location and use screws to safety it to the drive.  
Tighten the screws to a tightening torque of 0.98 N·m to 1.33 N·m (8.67 lb·in. to 11.77 lb·in.).

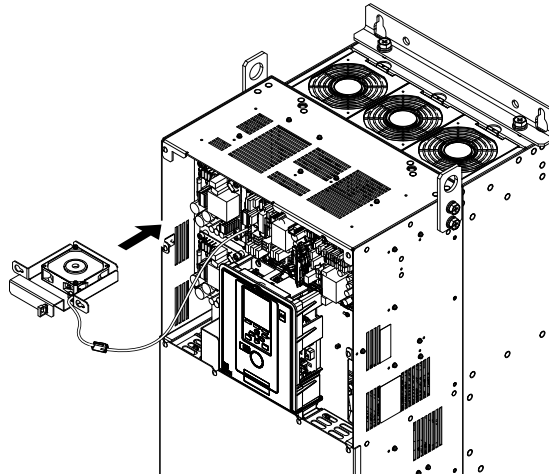
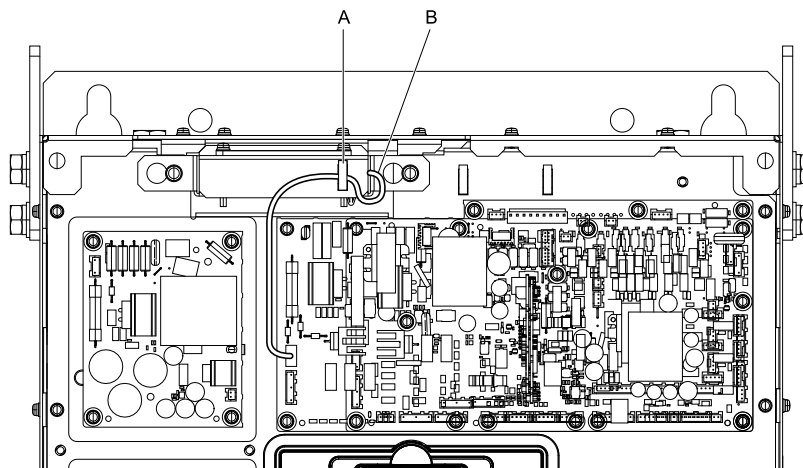


Figure 7.47 Install the Fan Unit

- Safety the fan cable to the hook.



A - Hook

B - Fan cable

- Reattach the drive cover.
- Energize the drive and set  $o4-03 = 0$  [Fan Operation Time Setting = 0 h] to reset the cooling fan operation time.

### ◆ Replace Fans (Procedure G)

**WARNING!** *Electrical Shock Hazard. Do not examine, connect, or disconnect wiring on an energized drive. Before servicing, disconnect all power to the equipment and wait for the time specified on the warning label at a minimum. The internal capacitor stays charged after the drive is de-energized. The charge indicator LED extinguishes when the DC bus voltage decreases below 50 Vdc. When all indicators are OFF, remove the covers before measuring for dangerous voltages to make sure that the drive is safe. Failure to obey will cause death or serious injury.*

**CAUTION!** *Burn Hazard. Do not touch a hot drive heatsink. De-energize the drive, wait 15 minutes minimum, and make sure that the heatsink is cool to replace the cooling fans. Failure to obey can cause minor to moderate injury.*

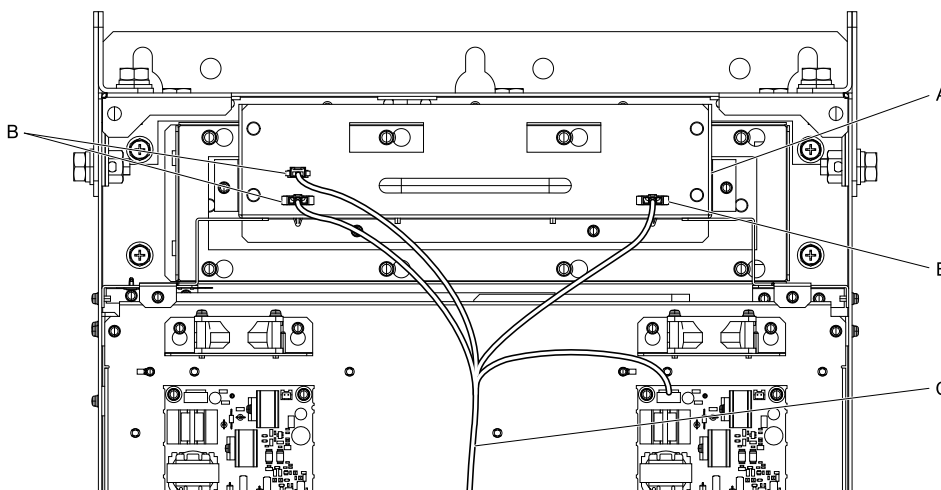
**NOTICE:** *Follow cooling fan replacement instructions. Replace all fans when performing maintenance to help ensure maximum useful product life. Improper fan replacement could cause damage the drive.*

### ■ Remove a Fan

- Remove the drive cover.

**CAUTION!** *Crush Hazard. Only loosen the cover screws. Do not fully remove the cover screws. Make sure that the covers do not fall. Missing cover screws can cause the cover to fall and cause injury.*

- Unplug the fan cables from the fan connectors.



A - Fan unit

B - Fan connector

C - Fan cable

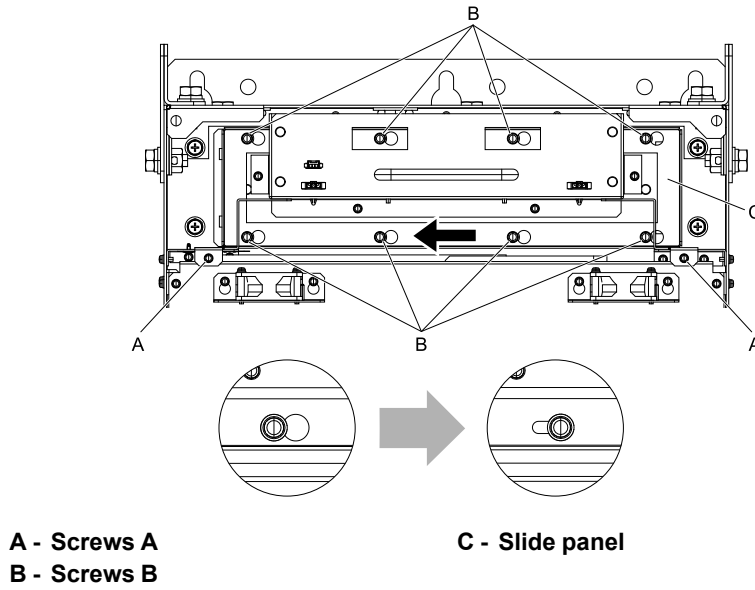
Figure 7.48 Circulation Fan Components

## 7.4 Replace a Cooling Fan and Circulation Fan

3. Loosen the fan unit screws and slide the slide panel to the left.

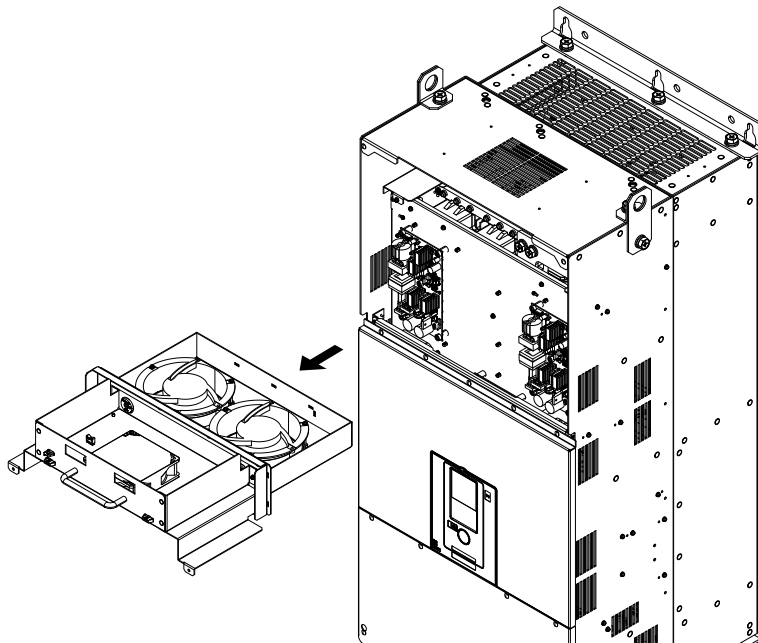
**Note:**

To remove the fan unit, it is only necessary to loosen the Screws B.



**Figure 7.49 Slide the Slide Panel**

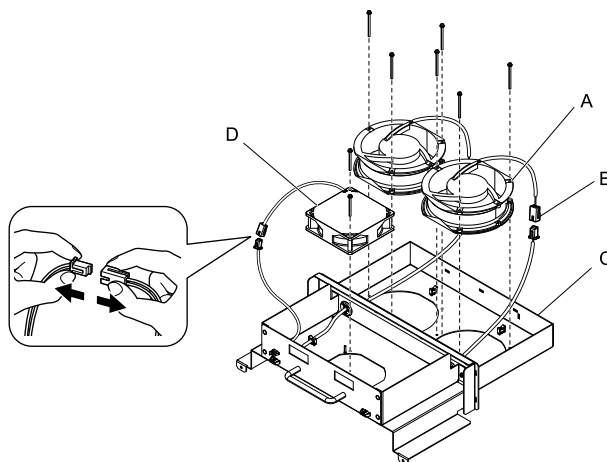
4. Remove the fan unit and the slide panel at the same time.



**Figure 7.50 Remove the Fan Unit**



5. Unplug the power supply connector, remove the screws that safety the cooling fan and circulation fan, and then remove the fans.



A - Cooling Fan  
B - Relay connector

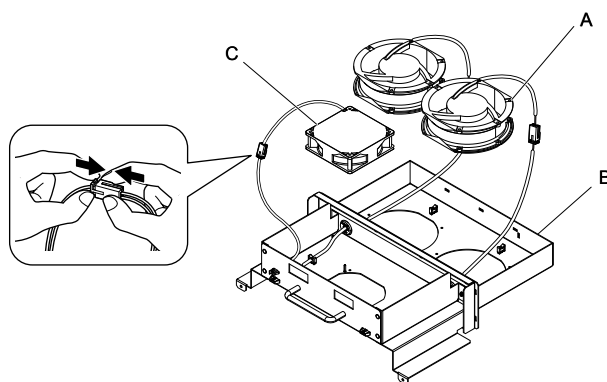
C - Fan unit base  
D - Circulation Fans

Figure 7.51 Remove the Cooling Fan

### ■ Install a Fan

Reverse the removal procedure to install a cooling fan.

1. Connect the drive and the fan connector.

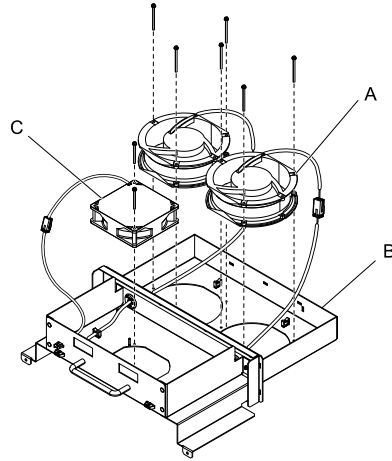


A - Cooling Fan  
B - Fan unit base

C - Circulation Fans

Figure 7.52 Connect Connector

2. Align the pins on the fan unit base with the notches on the fan, and use the screws to safety. Tighten the M4 screws to a tightening torque of 0.98 N·m to 1.33 N·m (8.67 lb·in. to 11.77 lb·in.).



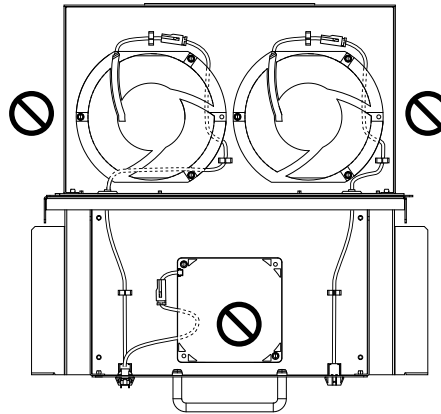
A - Cooling Fan  
B - Fan unit base

C - Circulation Fans

Figure 7.53 Install the Cooling Fan

**Note:**

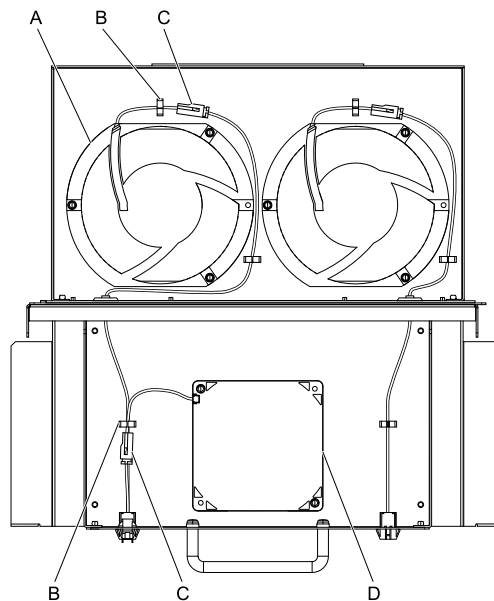
When you install the cooling fan, make sure that you do not pinch cables between the cooling fan and the fan unit base.



3. Put the cables in their initial locations.

**Note:**

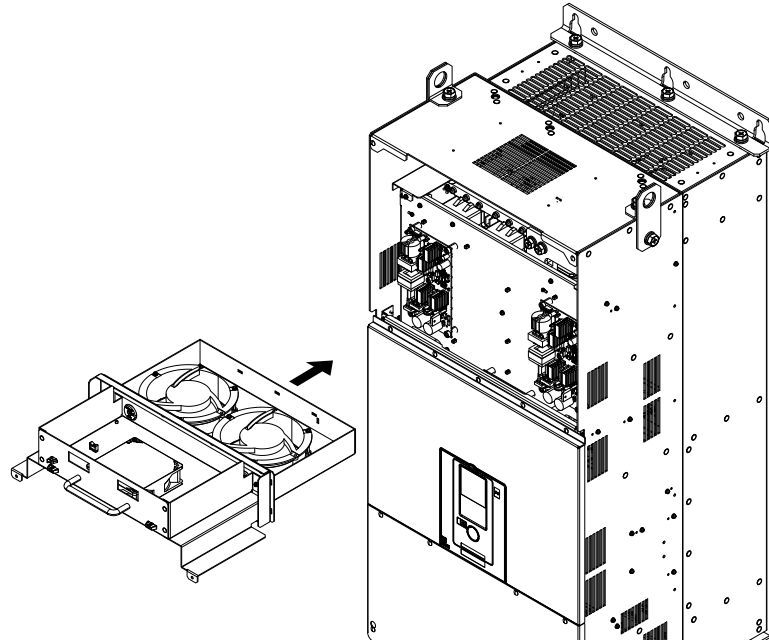
Safety the relay cable to the hook.



A - Cooling Fan  
B - Cable hook

C - Relay connector  
D - Circulation Fans

4. Put the fan unit into the specified location and use screws to safety it to the drive.  
Tighten the screws to a tightening torque of 1.96 N·m to 2.53 N·m (17.35 lb·in. to 22.39 lb·in.).



5. Connect the fan cable to the fan connector.

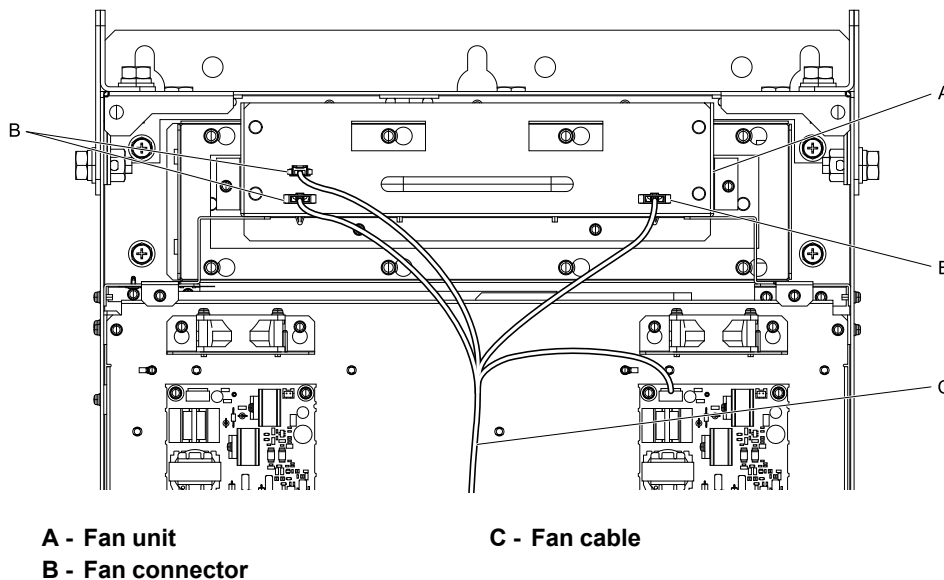


Figure 7.54 Connect Cooling Fan Connectors

6. Reattach the drive cover.
7. Energize the drive and set  $\alpha 4-03 = 0$  [Fan Operation Time Setting = 0 h] to reset the cooling fan operation time.

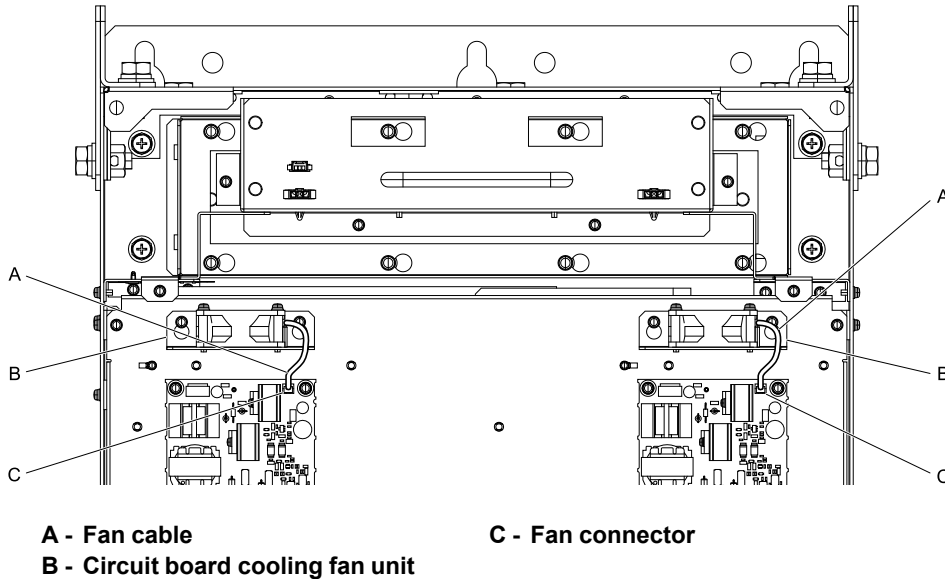
### ■ Remove the Circuit Board Cooling Fan

Remove the drive cover.

**CAUTION!** Crush Hazard. Only loosen the cover screws. Do not fully remove the cover screws. Make sure that the covers do not fall. Missing cover screws can cause the cover to fall and cause injury.

## 7.4 Replace a Cooling Fan and Circulation Fan

1. Unplug the fan cables from the fan connectors.

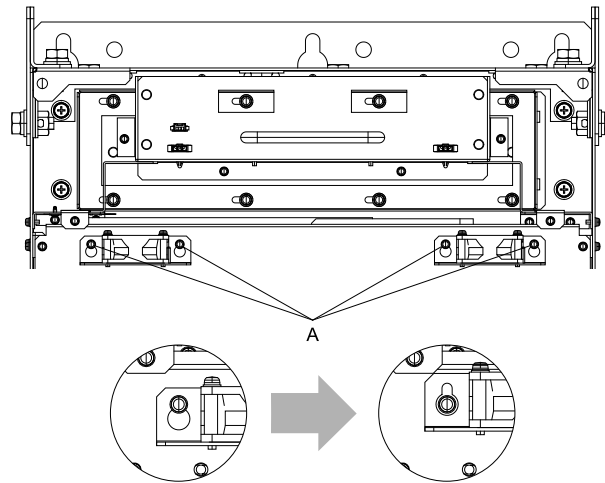


**Figure 7.55 Circulation Fan Components**

2. Loosen the circuit board cooling fan unit screws and slide the circuit board cooling fan unit up.

**Note:**

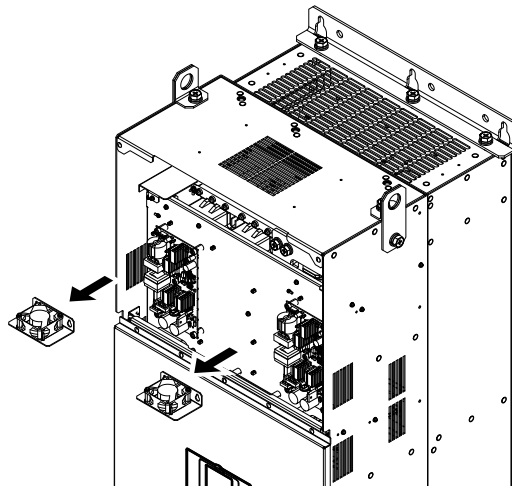
To remove the fan unit, it is only necessary to loosen the screws.



**A - Screws**

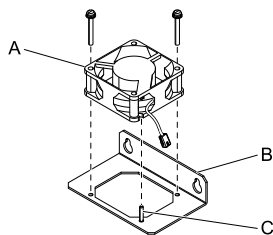
**Figure 7.56 Slide the Circuit Board Cooling Fan Unit**

3. Remove the circuit board cooling fan unit.



**Figure 7.57 Remove the Circuit Board Cooling Fan Unit**

- Remove the screws that safety the circuit board cooling fan and remove the fan.



A - Circuit Board Cooling Fans  
B - Fan unit base

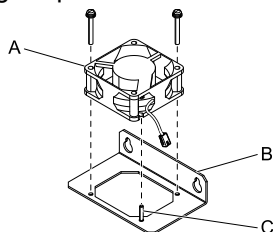
C - Alignment pin on fan unit base

Figure 7.58 Remove the Circuit Board Cooling Fan

### ■ Attach the Circuit Board Cooling Fan

Reverse the removal procedure to install a cooling fan.

- Align the pins on the fan unit base with the notches on the fan and put the circuit board cooling fan in the fan unit, then use the screws to safety the circuit board cooling fan to the fan unit base.  
Tighten the M4 screws to a tightening torque of 0.98 N·m to 1.33 N·m (8.67 lb·in. to 11.77 lb·in.).



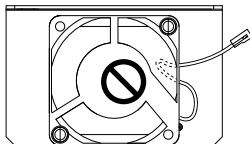
A - Circuit Board Cooling Fans  
B - Fan unit base

C - Alignment pin on fan unit base

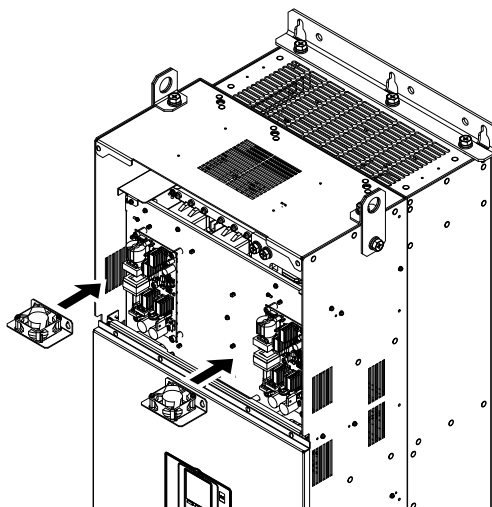
Figure 7.59 Attach the Circuit Board Cooling Fan

#### Note:

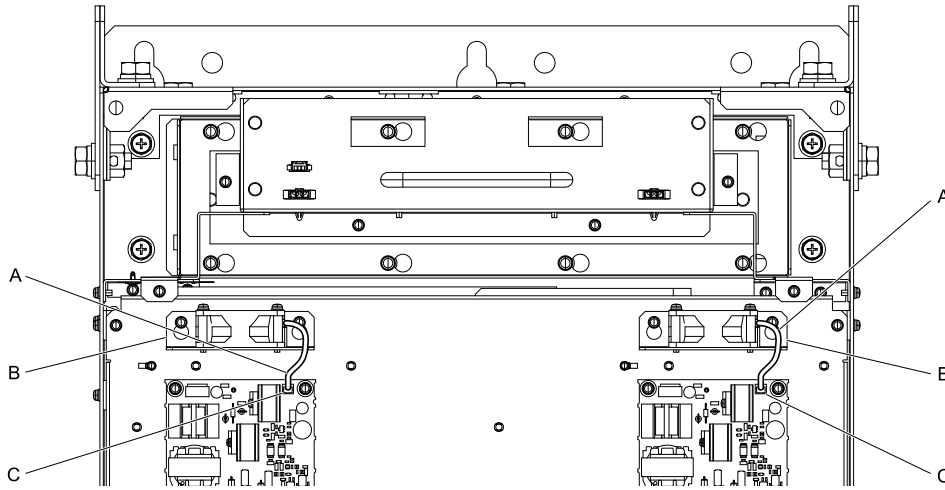
When you install the circuit board cooling fan, make sure that you do not pinch cables between the circuit board cooling fan and the fan unit base.



- Put the fan unit into the specified location and use screws to safety it to the drive.  
Tighten the screws to a tightening torque of 0.98 N·m to 1.33 N·m (8.67 lb·in. to 11.77 lb·in.).



3. Connect the fan cable to the fan connector.



A - Fan cable

C - Fan connector

B - Circuit board cooling fan unit

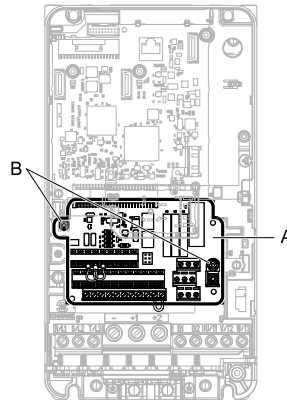
**Figure 7.60 Connect Cooling Fan Connectors**

4. Reattach the drive cover.
5. Energize the drive and set  $o4-03 = 0$  [*Fan Operation Time Setting = 0 h*] to reset the cooling fan operation time.

## 7.5 Replace the Drive

### ◆ About the Control Circuit Terminal Block

You can remove the control circuit terminal block of the drive and install a new terminal block. If there is a failure in the drive, you can use this feature to easily replace the control circuit terminal block.



A - Control circuit terminal block

B - Control circuit terminal block fastening screw

Figure 7.61 Control Circuit Terminal Block

### ◆ Replace the Drive

**WARNING! Electrical Shock Hazard.** While the drive is ON, never attempt to change any wiring, disconnect any option cards or connectors, or replace the cooling fan. Before performing any repairs, shut OFF the power supply to the drive and verify that there is no residual voltage in the unit. Failure to do so may result in serious electric shock.

**WARNING! Electrical Shock Hazard.** Only let authorized persons install, wire, maintain, examine, replace parts, and repair the drive. Failure to obey can cause death or serious injury.

**WARNING! Electrical Shock Hazard.** Do not examine, connect, or disconnect wiring on an energized drive. Before servicing, disconnect all power to the equipment and wait for the time specified on the warning label at a minimum. The internal capacitor stays charged after the drive is de-energized. The charge indicator LED extinguishes when the DC bus voltage decreases below 50 Vdc. When all indicators are OFF, remove the covers before measuring for dangerous voltages to make sure that the drive is safe. Failure to obey will cause death or serious injury.

**NOTICE:** Observe correct electrostatic discharge (ESD) procedures when touching the drive and circuit boards. Failure to obey can cause ESD damage to the drive circuitry.

### ■ Notes on Wiring the Main Circuit Terminal Block

Read these notes before you wire the main circuit terminal block.

## 7.5 Replace the Drive

### Note:

- Use UL-Listed, vinyl-coated insulated copper wires for operation with a continuous maximum permitted temperature of 75 °C at 600 V
- Remove all unwanted objects that are near the terminal block connections.
- Remove the insulation from the connection wires to the wire stripping lengths shown in the manual.
- Do not use bent or crushed wires. Remove the damaged end of the wire before you use it. Incorrect connections can cause death or serious injury from fire.
- Do not solder stranded wire. Soldered wire connections can become loose over time and cause unsatisfactory drive performance.
- If you use stranded wire, make sure that all of the wire strands are in the connection. Also, do not twist the stranded wire too much. Incorrect connections can cause death or serious injury from fire.
- Put the wire all the way into the terminal block. Remove the insulation from the wire to the recommended wire stripping length to fit the wire with insulation in the plastic housing.
- Use a torque driver, torque ratchet, or torque wrench for the screws. A slotted driver or a hex tool will be necessary to wire the screw clamp terminal. Use applicable tools as specified by the recommended conditions in the product manual.
- If you use power tools to tighten the terminal screws, use a low speed setting (300 to 400 r/min). Failure to obey can cause damage to the terminal screws.
- Users can purchase wiring tools from Yaskawa. Contact Yaskawa or your nearest sales representative for more information.
- Wire gauges on existing drive models to be replaced may not match wire gauge ranges on new drives. Contact Yaskawa or your nearest sales representative for wire gauges that you can and cannot use.
- Do not tighten the terminal screws at an angle of 5 degrees or more. Failure to obey can cause damage to the terminal screws.

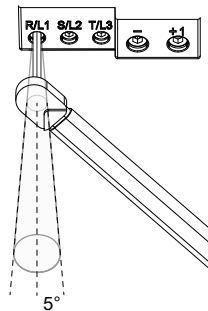


Figure 7.62 Permitted Angle

- Put the bit all the way into the hex socket to tighten the hex socket cap screw.
- When tightening slotted screws, hold the straight-edge screwdriver perpendicularly to the screw. Do not allow the tip of the screwdriver to shift or protrude from the groove of the screw.

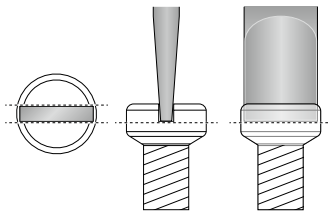
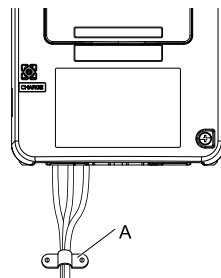


Figure 7.63 Tightening Slotted Screws

- After connecting the wires to the terminal block, lightly pull on the wires to make sure that they do not come out of the terminals.
- Remove the correct section of the wiring cover to make wiring easier.
- Do not let strain on the wiring cause damage. Use a strain relief near the wiring to release the tension. Refer to Figure 7.64 for an example.



A - Strain relief

Figure 7.64 Strain Relief Example



Table 7.13 Recommended Wiring Tools

Screw Size	Screw Shape	Adapter	Bit		Torque Driver Model (Tightening Torque)	Torque Wrench
			Model	Manufacturer		
M4	Slotted (-)	Bit	SF-BIT-SL 1,0X4,0-70	PHOENIX CONTACT	TSD-M 3NM (1.2 - 3 N·m)	-
M5 *1	Slotted (-)	Bit	SF-BIT-SL 1,2X6,5-70	PHOENIX CONTACT	Wire Gauge $\leq$ 25 mm <sup>2</sup> (AWG 10): TSD-M 3NM (1.2 - 3 N·m)	Wire Gauge $\leq$ 25 mm <sup>2</sup> (AWG 10): -
					Wire Gauge $\geq$ 30 mm <sup>2</sup> (AWG 8): -	Wire Gauge $\geq$ 30 mm <sup>2</sup> (AWG 8): 4.1 - 4.5 N·m *2 *3
M6	Hex socket cap (WAF: 5 mm)	Bit	SF-BIT-HEX 5-50	PHOENIX CONTACT	-	5 - 9 N·m *2 *3
	Slotted (-)	Bit	SF-BIT-SL 1,2X6,5-70	PHOENIX CONTACT	-	3 - 3.5 N·m *2 *3
M8	Hex socket cap (WAF: 6 mm)	Bit	SF-BIT-HEX 6-50	PHOENIX CONTACT	-	8 - 12 N·m *2 *3
M10	Hex socket cap (WAF: 8 mm)	Bit	SF-BIT-HEX 8-50	PHOENIX CONTACT	-	12 - 14 N·m *2 *3

\*1 When wiring drive models 2056 and 4089 and smaller, select the correct tools for the wire gauge.

\*2 Use 6.35 mm (0.25 in) bit socket holder.

\*3 Use a torque wrench that can apply this torque measurement range.

## ■ Remove the Control Circuit Terminal Block

Remove the keypad and the drive front cover before doing these steps.

1. Loosen the screws on the control circuit terminal block.

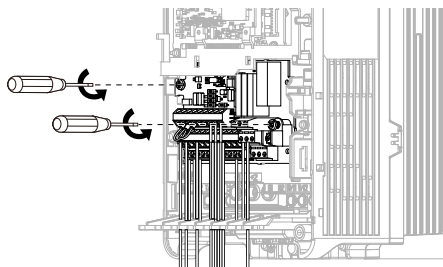


Figure 7.65 Loosen the Screws

2. Slide the wired control circuit terminal block down and remove it.

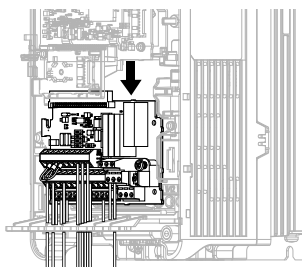


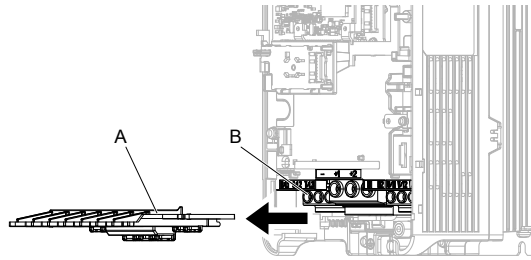
Figure 7.66 Remove the Control Circuit Terminal Block

## ■ Wire a New Drive

Remove the keypad, front cover, and control circuit terminal block of the new drive. Wire the drive to the main circuit terminal block before you install a wired control circuit terminal block.

## 7.5 Replace the Drive

1. Pull the wiring cover away from the drive to remove it.



**A - Wiring cover**

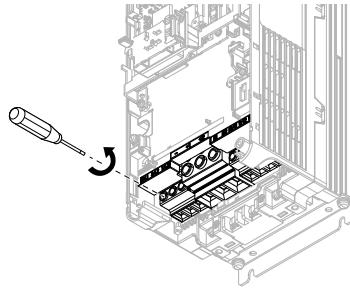
**B - Main circuit terminal block**

**Figure 7.67 Remove the Wiring Cover**

2. Loosen the main circuit terminal block screws to fully open the terminal block opening.

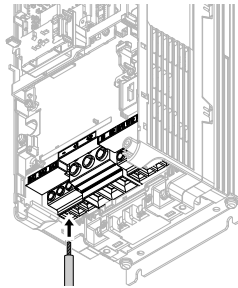
**Note:**

The terminal block openings ship from the factory as fully open.



**Figure 7.68 Loosen Terminal Block Screws**

3. Put a wire with prepared ends into the main circuit terminal block.

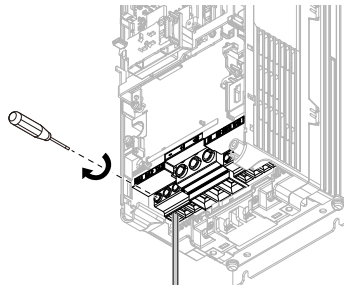


**Figure 7.69 Install the Electrical Wire**

**Note:**

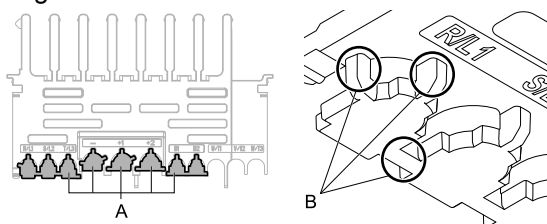
If there is a jumper between terminals +1 and +2, loosen the terminal block screws to remove the jumper before you wire to terminals +1 and +2.

4. Tighten the screws to the specified torque.



**Figure 7.70 Tighten Terminal Block Screws**

5. Check the terminal sign that you wired and use a nipper as shown in [Figure 7.71](#) to clip the specified cutaway section of the wiring cover.



A - Cutaway sections

B - Clip here with nippers

Figure 7.71 Clip the Cutaway Section of the Wiring Cover

**Note:**

- Different drive models have different wiring cover shapes.
- Only clip the section of the wiring cover that applies to the wired terminal. If you clip areas that do not apply to wired terminals, the protective enclosure will not keep its IP20 protective level.
- Be careful when clipping the cutaway section of the wiring cover, as the section may fly out in unpredictable directions.
- Make sure that the clipped section does not cause damage to the wires.
- If you use wires that are not specified by Yaskawa, the protective enclosure could lose its IP20 protective level, although the wiring cover is correct. Contact Yaskawa or your nearest sales representative for more information.

6. Put the wiring cover in its initial position. Put the cables through the holes that you cut out of the wiring cover.

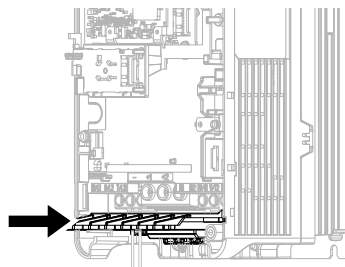
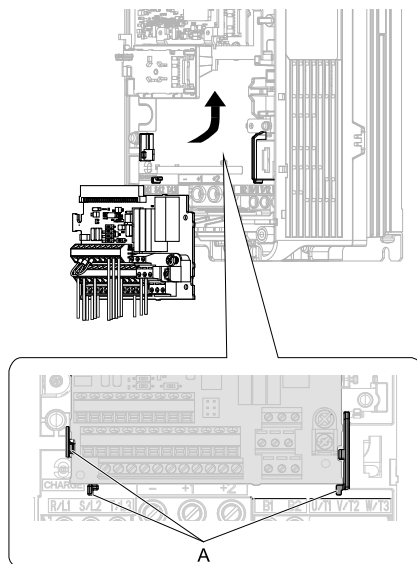


Figure 7.72 Reattach the Wiring Cover

## ■ Connect the Control Circuit Terminal Block

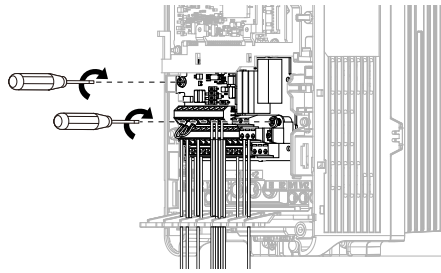
1. To put a wired control circuit terminal block in the drive, align it with the guides and move it straight up.



A - Guides

Figure 7.73 Put the Terminal Block into the Connector

2. Tighten the M3 screws to a tightening torque of 0.5 N·m to 0.6 N·m (4.4 lb·in. to 5.3 lb·in.).



**Figure 7.74 Safety the Terminal Block**

3. Install the front cover and the keypad to their initial positions.
4. Check *o2-04 [Drive Model (KVA) Selection]*.

**Note:**

- When you save parameter information in a keypad that you installed before you replaced the terminal block, make sure that you use that keypad to restore the parameter data.
- To reset the performance life monitors for the components, set *o4-01 to o4-13 [Maintenance Period]*.

## 7.6 Replace the Keypad Battery

When the keypad battery is expired, the date and time go back to the default settings. Use this procedure to replace the battery.

**WARNING! Preventing Fire.** Handle keypad batteries properly. Do not attempt to charge the battery or disassemble the keypad. Improper handling may result in batteries bursting and igniting, which could cause fire and injury.

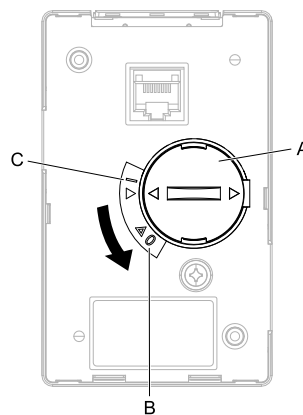
To replace the battery, use a Hitachi Maxell “CR2016 Lithium Manganese Dioxide Lithium Battery” or an equivalent battery with these properties:

- Nominal voltage: 3 V
- Operating temperature range: -20°C to +85°C (-4°F to +185°F)

**WARNING! Preventing Fire.** Do not disassemble batteries. Do not expose batteries to heat or fire. Improper handling may result in batteries bursting and igniting, which could cause fire and injury.

**NOTICE:** The battery remains in use even when power to the drive has been shut off. Be sure to also remove the battery in the keypad when the drive will be shut off for long periods of time. Replace the battery with a new one immediately after the expected lifespan has passed. A dead battery left inside the keypad may leak and damage the keypad and drive.

1. De-energize the drive and remove the keypad.
2. Use a slotted screwdriver to turn the battery cover counterclockwise and remove the cover.



A - Battery cover  
B - Opened

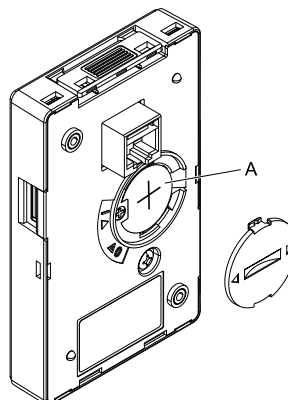
C - Closed

Figure 7.75 Remove the Battery Cover

3. Remove the used battery from the keypad.
4. Insert the new battery.

**Note:**

- The battery cover side is the positive pole. Make sure that the polarity is correct when you put the battery in the keypad.
- Discard the used battery as specified by local regulations.



A - Battery

Figure 7.76 Insert the New Battery

5. Put the battery cover on the keypad and use a slotted screwdriver to turn the battery cover clockwise to close it.
6. Install the keypad on the drive.

## 7.7 Storage Guidelines

The chemicals in the electrolytic capacitors and other electronic parts of the drive change over time. When you store the drive for long periods of time, use the information in this section to help keep the performance life estimates.

### ◆ Storage Location

- Temperature and Humidity

Put the drive in a location where the temperature is between  $-10\text{ }^{\circ}\text{C}$  to  $+40\text{ }^{\circ}\text{C}$  ( $14\text{ }^{\circ}\text{F}$  to  $104\text{ }^{\circ}\text{F}$ ) and the relative humidity is 95% or less. Do not put the drive in direct sunlight or where there will be condensation or ice. When you are storing the drive for a maximum of one month, you can put the drive in a location where the temperature is  $-20\text{ }^{\circ}\text{C}$  to  $+70\text{ }^{\circ}\text{C}$  ( $4\text{ }^{\circ}\text{F}$  to  $158\text{ }^{\circ}\text{F}$ ).

**Note:**

Correctly package and store the drive during shipping to prevent vibration and shock damage.

- Dust and Oil Mist

Do not keep the drive locations with dust or oil mist. For example, cement factories and cotton mills.

- Corrosive Gas

Do not keep the drive in locations with corrosive gas. For example, chemical plants, refineries, and sewage plants.

- Salt Damage

Do not keep the drive in salty locations. For example, locations near the ocean, and salt damage-designated locations.

Do not keep the drive in unsatisfactory locations. Keep all drives in storage rooms that are safe from unsatisfactory elements.

### ◆ Regular Application of Power

To prevent deterioration of the capacitors, Yaskawa recommends that you apply power to the drive a minimum of one time each year for a minimum of 30 minutes.

If you store the drive for longer than two years and do not apply power, Yaskawa recommends that you use a variable power source and gradually increase the power from 0 V to the rated drive voltage over a period of 2 to 3 minutes. Apply power for a minimum of 1 hour with no load to reform the main circuit electrolytic capacitor.

When you operate the drive after you apply power, wire the drive correctly and check for drive faults, overcurrents, motor vibration, motor speed differences, and other defects during operation.

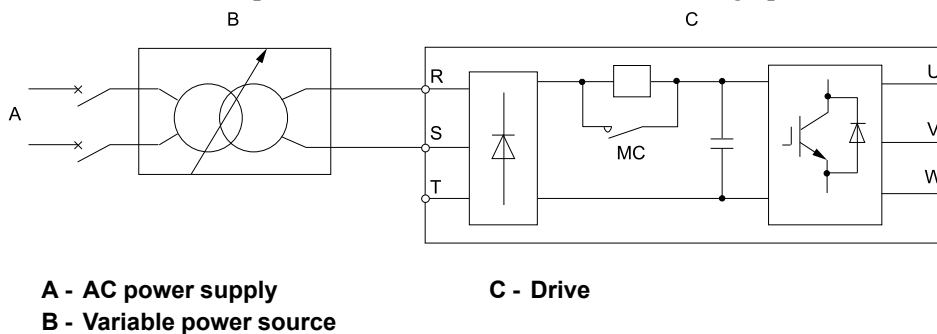


Figure 7.77 Power Distribution Method

## Disposal

---

8.1	Section Safety .....	440
8.2	Disposal Instructions .....	441

## 8.1 Section Safety

### DANGER

#### Electrical Shock Hazard

**Make sure that all electrical connections are correct and install all drive covers before energizing the drive. Use terminals for their intended function only.**

Incorrect wiring or ground connections, and incorrect repair of protective covers can cause death or serious injury.

### WARNING

#### Electrical Shock Hazard

**Only let authorized persons install, wire, maintain, examine, replace parts, and repair the drive.**

Failure to obey can cause death or serious injury.

**Do not work on the drive or around the drive while wearing loose clothing or jewelry. Tighten loose clothing and remove all metal objects such as watches or rings.**

Failure to obey can cause death or serious injury.

#### Preventing Fire

**Handle keypad batteries properly. Do not attempt to charge the battery or disassemble the keypad.**

Improper handling may result in batteries bursting and igniting, which could cause fire and injury.

**Do not disassemble batteries. Do not expose batteries to heat or fire.**

Improper handling may result in batteries bursting and igniting, which could cause fire and injury.

#### Sudden Movement Hazard

**Do not do work on the drive without eye protection. Wear eye protection before you start work on the drive.**

Failure to obey could cause serious injury or death.

#### Crush Hazard

**Only approved personnel can operate a crane or hoist to move the drive.**

Failure to obey can cause death or serious injury from falling equipment.

**Use a lifting mechanism made to move large drives when necessary.**

Failure to obey can cause death or serious injury from falling equipment.

### CAUTION

#### Crush Hazard

**Do not hold the drive by the front cover or terminal cover. Tighten the screws correctly before moving the drive.**

Failure to obey can cause minor to moderate injury.

### NOTICE

**The battery remains in use even when power to the drive has been shut off. Be sure to also remove the battery in the keypad when the drive will be shut off for long periods of time. Replace the battery with a new one immediately after the expected lifespan has passed.**

A dead battery left inside the keypad may leak and damage the keypad and drive.



## 8.2 Disposal Instructions

Correctly discard the drive, packing material, battery, and microSD card as specified by regional, local, and municipal laws and regulations for this product. (Example: European Waste 16 02 14)

**Note:**

- Remove the battery and microSD card from the keypad before you discard the drive.
- You cannot recycle the battery. Discard used batteries as specified by the battery manufacturer.
- Customers are responsible for microSD card data protection. PC functions that format and delete the data may not be sufficient to fully erase the microSD card data.  
Yaskawa recommends that customers physically destroy the microSD card in a shredder or use data wipe software to fully erase the card.



# Specifications

---

<b>9.1</b>	<b>Safety Precautions</b> .....	<b>444</b>
<b>9.2</b>	<b>Drive Duty Modes</b> .....	<b>445</b>
<b>9.3</b>	<b>Model Specifications (200 V Class)</b> .....	<b>446</b>
<b>9.4</b>	<b>Model Specifications (400 V Class)</b> .....	<b>449</b>
<b>9.5</b>	<b>Drive Specifications</b> .....	<b>456</b>
<b>9.6</b>	<b>Drive Derating</b> .....	<b>460</b>
<b>9.7</b>	<b>Drive Exterior and Mounting Dimensions</b> .....	<b>465</b>
<b>9.8</b>	<b>Knock-Out Hole Dimensions (UL Type 1)</b> .....	<b>485</b>
<b>9.9</b>	<b>Peripheral Devices and Options</b> .....	<b>490</b>

## 9.1 Safety Precautions

### DANGER

**Do not ignore the safety messages in this manual. The operating company is responsible for injuries or equipment damage caused from ignoring the messages in this manual.**

Failure to obey the safety messages will cause death or serious injury.

## 9.2 Drive Duty Modes

The drive has two duty modes from which to select for the application: Heavy Duty (HD) and Normal Duty (ND). When  $E1-01$  [Input AC Supply Voltage]  $\geq 460$  V, the duty rating switches to HD2 or ND2. The specifications listed here are different between HD1 and HD2 and ND1 and ND2.

- The input power kVA
- The maximum applicable motor output
- The rated input current
- The rated output capacity
- The rated output current

Refer to [Table 9.1](#) for information about the differences between HD and ND ratings.

**Table 9.1 Drive Duty Modes**

Duty Rating	E1-01 Setting Input Voltage	C6-01 Setting	Application	Default Carrier Frequency	Overload Tolerance (oL2 [Drive Overload])
Heavy Duty Rating 1 (HD1)	<ul style="list-style-type: none"> <li>• <math>\geq 200</math> V and <math>&lt; 240</math> V</li> <li>• <math>\geq 380</math> V and <math>&lt; 460</math> V</li> </ul>	0	<ul style="list-style-type: none"> <li>• Extruder</li> <li>• Conveyor</li> <li>• Constant torque or high overload capacity</li> </ul>	2 kHz	150% rated output current for 60 seconds
Heavy Duty Rating 2 (HD2)	$\geq 460$ V and $< 480$ V				
Normal Duty Rating 1 (ND1)	<ul style="list-style-type: none"> <li>• <math>\geq 200</math> V and <math>&lt; 240</math> V</li> <li>• <math>\geq 380</math> V and <math>&lt; 460</math> V</li> </ul>	1	<ul style="list-style-type: none"> <li>• Fan</li> <li>• Pump</li> <li>• Blower</li> <li>• Variable speed control</li> </ul>	2 kHz Swing-PWM	110% rated output current for 60 seconds
Normal Duty Rating 2 (ND2)	$\geq 460$ V and $< 480$ V				

## 9.3 Model Specifications (200 V Class)

Table 9.2 Rating (200 V Class)

Model		2004	2006	2010	2012	2018	2021	2030	2042	
Maximum Applicable Motor Output (kW)	HD1 *1	0.55	0.75	1.5	2.2	3	4	5.5	7.5	
	ND1 *2	0.75	1.1	2.2	3	4	5.5	7.5	11	
Maximum Applicable Motor Output (HP)	HD1 *1	1/2	1	2	3	4	5	7 1/2	10	
	ND1 *2	3/4	1 1/2	3	4	5	7 1/2	10	15	
Input	Rated Input Current *3 (A)	HD1 (AC)	3.6	4.8	8.9	12.7	17	20.7	30	40.3
		HD1 (DC)	4.5	5.9	11	16	21	25	37	49
		ND1 (AC)	4.8	6.7	12.7	17	20.7	30	40.3	52
		ND1 (DC)	5.9	8.2	16	21	25	37	49	71
Outputs	Rated Output Capacity (kVA)	HD1 *4	1.2	1.9	3.0	4.2	5.3	6.7	9.5	12.6
		ND1 *5	1.3	2.3	3.7	4.6	6.7	8.0	11.4	16.0
	Rated Output Current (A)	HD1	3.2	5	8	11	14	17.5	25	33
		ND1	3.5	6	9.6	12.2	17.5	21	30	42
	Overload Tolerance	<ul style="list-style-type: none"> <li>• HD: 150% of the rated output current for 60 seconds</li> <li>• ND: 110% of the rated output current for 60 seconds</li> </ul> <b>Note:</b> Derating may be necessary for applications that start and stop frequently.								
	Carrier Frequency	HD1: 8 kHz without derating the drive capacity. ND1: 2 kHz without derating the drive capacity. Derate the drive capacity to use values to 15 kHz maximum.								
Maximum Output Voltage	Three-phase 200 V to 240 V <b>Note:</b> The maximum output voltage is proportional to the input voltage.									
Maximum Output Frequency	<ul style="list-style-type: none"> <li>• Advanced Open Loop Vector Control (AOLV) and EZ Open Loop Vector Control (EZOLV): 120 Hz</li> <li>• Closed Loop V/f Control (CL-V/f), Closed Loop Vector Control (CLV), Advanced Open Loop Vector Control for PM (AOLV/PM), and Closed Loop Vector Control for PM (CLV/PM): 400 Hz</li> <li>• V/f Control (V/f), Open Loop Vector Control (OLV), and Open Loop Vector Control for PM (OLV/PM): 590 Hz</li> </ul>									
Measures for Harmonics	DC Reactor	External options								
Braking Device	Braking Transistor	Standard internal characteristics								
EMC Filter	EMC Filter IEC61800-3, C2/C3	Factory option <ul style="list-style-type: none"> <li>• Models 2xxxB: There is a category C3 EMC filter in the drive.</li> <li>• Models 2xxxC: There is a category C2 EMC filter in the drive.</li> </ul>								
Power Supply	Rated Voltage/Rated Frequency	<ul style="list-style-type: none"> <li>• Three-phase AC power supply 200 V to 240 V at 50/60 Hz</li> <li>• DC power supply 270 V to 340 V</li> </ul>								
	Permitted Voltage Fluctuation	-15% to +10%								
	Permitted Frequency Fluctuation	±5%								
	Input Power (kVA)	HD1	1.5	2.0	3.7	5.3	7.1	8.6	12.5	16.8
ND1		2.0	2.8	5.3	7.1	8.6	12.5	16.8	21.6	

\*1 The maximum applicable motor output complies with 208 V motor ratings as specified in NEC Table 430.250. The rated output current of the drive output amps must be equal to or more than the motor rated current.

\*2 The maximum applicable motor output is based on 4-pole, general-purpose 220 V motor ratings. The rated output current of the drive output amps must be equal to or more than the motor rated current.

- \*3 Assumes the value at the rated output current. The input current rating changes when the power supply transformer, input reactor, wiring connections, or power supply impedance change.
- \*4 The rated output capacity is calculated with a rated output voltage of 208 V.
- \*5 The rated output capacity is calculated with a rated output voltage of 220 V.

**Table 9.3 Rating (200 V Class)**

Model		2056	2070	2082	2110	2138	
Maximum Applicable Motor Output (kW)	HD1 *1	11	15	18.5	22	30	
	ND1 *2	15	18.5	22	30	37	
Maximum Applicable Motor Output (HP)	HD1 *1	15	20	25	30	40	
	ND1 *2	20	25	30	40	50	
Input	Rated Input Current *3(A)	HD1 (AC)	58.2	78.4	96	82	111
		HD1 (DC)	71	96	118	101	136
		ND1 (AC)	78.4	96	114	111	136
		ND1 (DC)	96	118	139	136	167
Outputs	Rated Output Capacity (kVA)	HD1 *4	17.9	22.9	28.6	33.5	43.8
		ND1 *5	21.3	26.7	31.2	41.9	52.6
	Rated Output Current (A)	HD1	47	60	75	88	115
		ND1	56	70	82	110	138
	Overload Tolerance	<ul style="list-style-type: none"> <li>• HD: 150% of the rated output current for 60 seconds</li> <li>• ND: 110% of the rated output current for 60 seconds</li> </ul> <b>Note:</b> Derating may be necessary for applications that start and stop frequently.					
	Carrier Frequency	HD1: 8 kHz without derating the drive capacity. ND1: 2 kHz without derating the drive capacity. Derate the drive capacity to use values to 15 kHz maximum.					
Maximum Output Voltage	Three-phase 200 V to 240 V <b>Note:</b> The maximum output voltage is proportional to the input voltage.						
Maximum Output Frequency	<ul style="list-style-type: none"> <li>• Advanced Open Loop Vector Control (AOLV) and EZ Open Loop Vector Control (EZOLV): 120 Hz</li> <li>• Closed Loop V/f Control (CL-V/f), Closed Loop Vector Control (CLV), Advanced Open Loop Vector Control for PM (AOLV/PM), and Closed Loop Vector Control for PM (CLV/PM): 400 Hz</li> <li>• V/f Control (V/f), Open Loop Vector Control (OLV), and Open Loop Vector Control for PM (OLV/PM): 590 Hz</li> </ul>						
Measures for Harmonics	DC Reactor	External options			Standard internal characteristics		
Braking Device	Braking Transistor	Standard internal characteristics					
EMC Filter	EMC Filter IEC61800-3, C2/C3	Factory option <ul style="list-style-type: none"> <li>• Models 2xxxB: There is a category C3 EMC filter in the drive.</li> <li>• Models 2xxxC: There is a category C2 EMC filter in the drive.</li> </ul>					
Power Supply	Rated Voltage/Rated Frequency		<ul style="list-style-type: none"> <li>• Three-phase AC power supply 200 V to 240 V at 50/60 Hz</li> <li>• DC power supply 270 V to 340 V</li> </ul>				
	Permitted Voltage Fluctuation		-15% to +10%				
	Permitted Frequency Fluctuation		±5%				
	Input Power (kVA)	HD1	24.2	32.6	39.9	34.1	46.1
ND1		32.6	39.9	47.4	46.1	56.5	

- \*1 The maximum applicable motor output complies with 208 V motor ratings as specified in NEC Table 430.250. The rated output current of the drive output amps must be equal to or more than the motor rated current.
- \*2 The maximum applicable motor output is based on 4-pole, general-purpose 220 V motor ratings. The rated output current of the drive output amps must be equal to or more than the motor rated current.
- \*3 Assumes the value at the rated output current. The input current rating changes when the power supply transformer, input reactor, wiring connections, or power supply impedance change.
- \*4 The rated output capacity is calculated with a rated output voltage of 208 V.

## 9.3 Model Specifications (200 V Class)

\*5 The rated output capacity is calculated with a rated output voltage of 220 V.

**Table 9.4 Rating (200 V Class)**

Model		2169	2211	2257	2313	2360	2415	
Maximum Applicable Motor Output (kW)	HD1 *1	37	45	55	75	90	110	
	ND1 *2	45	55	75	90	110	-	
Maximum Applicable Motor Output (HP)	HD1 *1	50	60	75	100	125	150	
	ND1 *2	60	75	100	125	150	-	
Input	Rated Input Current *3(A)	HD1 (AC)	136	164	200	271	324	394
		HD1 (DC)	167	202	245	332	397	483
		ND1 (AC)	164	200	271	324	394	-
		ND1 (DC)	202	245	332	397	483	-
Outputs	Rated Output Capacity (kVA)	HD1 *4	55.3	68.6	81.9	108	132	158
		ND1 *5	64.4	80.4	97.9	119	137	-
	Rated Output Current (A)	HD1	145	180	215	283	346	415
		ND1	169	211	257	313	360	-
	Overload Tolerance		<ul style="list-style-type: none"> <li>• HD: 150% of the rated output current for 60 seconds</li> <li>• ND: 110% of the rated output current for 60 seconds</li> </ul> <b>Note:</b> Derating may be necessary for applications that start and stop frequently.					
	Carrier Frequency		HD1: 5 kHz without derating the drive capacity. ND: 2 kHz without derating the drive capacity. Derate the drive capacity to use values to 10 kHz maximum.					
Maximum Output Voltage		Three-phase 200 V to 240 V <b>Note:</b> The maximum output voltage is proportional to the input voltage.						
Maximum Output Frequency		<ul style="list-style-type: none"> <li>• Advanced Open Loop Vector Control (AOLV) and EZ Open Loop Vector Control (EZOLV): 120 Hz</li> <li>• Closed Loop V/f Control (CL-V/f), Closed Loop Vector Control (CLV), Advanced Open Loop Vector Control for PM (AOLV/PM), and Closed Loop Vector Control for PM (CLV/PM): 400 Hz</li> <li>• V/f Control (V/f), Open Loop Vector Control (OLV), and Open Loop Vector Control for PM (OLV/PM): 590 Hz</li> </ul>						
Measures for Harmonics	DC Reactor	Standard internal characteristics						
Braking Device	Braking Transistor	External options						
EMC Filter	EMC Filter IEC61800-3, C2/C3	Factory option <ul style="list-style-type: none"> <li>• Models 2xxxB: There is a category C3 EMC filter in the drive.</li> <li>• Models 2xxxC: There is a category C2 EMC filter in the drive.</li> </ul>						
Power Supply	Rated Voltage/Rated Frequency	<ul style="list-style-type: none"> <li>• Three-phase AC power supply 200 V to 240 V at 50/60 Hz</li> <li>• DC power supply 270 V to 340 V</li> </ul>						
	Permitted Voltage Fluctuation	-15% to +10%						
	Permitted Frequency Fluctuation	±5%						
	Input Power (kVA)	HD1	56.5	68.2	83.1	113	135	164
ND1		68.2	83.1	113	135	164	-	

\*1 The maximum applicable motor output complies with 208 V motor ratings as specified in NEC Table 430.250. The rated output current of the drive output amps must be equal to or more than the motor rated current.

\*2 The maximum applicable motor output is based on 4-pole, general-purpose 220 V motor ratings. The rated output current of the drive output amps must be equal to or more than the motor rated current.

\*3 Assumes the value at the rated output current. The input current rating changes when the power supply transformer, input reactor, wiring connections, or power supply impedance change.

\*4 The rated output capacity is calculated with a rated output voltage of 208 V.

\*5 The rated output capacity is calculated with a rated output voltage of 220 V.



## 9.4 Model Specifications (400 V Class)

Table 9.5 Rating (400 V Class)

Model		Input Voltage	Duty Rating	4002	4004	4005	4007	4009	4012	4018	4023	
Maximum Applicable Motor Output (kW)		< 460 V <sup>*1</sup>	HD1	0.55	0.75	1.5	2.2	3	3.7	5.5	7.5	
			ND1	0.75	1.5	2.2	3	3.7	5.5	7.5	11	
		≥ 460 V <sup>*2</sup>	HD2	0.55	0.75	1.5	2.2	3	3.7	5.5	7.5	7.5
			ND2	0.75	1.5	2.2	3	3.7	5.5	7.5	7.5	11
Maximum Applicable Motor Output (HP)		< 460 V <sup>*1</sup>	HD1	3/4	1	2	3	4	5	7 1/2	10	
			ND1	1	2	3	4	5	7 1/2	10	15	
		≥ 460 V <sup>*2</sup>	HD2	3/4	1	2	3	4	5	7 1/2	10	10
			ND2	1	2	3	4	5	7 1/2	10	10	15
Input	Rated Input Current (A) <sup>*3</sup>	< 460 V	HD1 (AC)	1.9	3.5	4.7	6.7	8.9	11.7	15.8	21.2	
			HD1 (DC)	2.3	4.3	5.8	8.2	11	15	20	26	
			ND1 (AC)	2.5	4.7	6.7	8.9	11.7	15.8	21.2	30.6	
			ND1 (DC)	3.1	5.8	8.2	11	15	20	26	38	
		≥ 460 V	HD2 (AC)	1.6	2.1	3.9	5.5	7.4	9.0	13.1	17.5	
			HD2 (DC)	1.9	2.5	4.8	6.8	9.0	11	16	22	
			ND2 (AC)	2.1	3.9	5.5	7.4	9.0	13.1	17.5	25.3	
			ND2 (DC)	2.5	4.8	6.8	9.0	11	16	22	31	

## 9.4 Model Specifications (400 V Class)

Model		Input Voltage	Duty Rating	4002	4004	4005	4007	4009	4012	4018	4023	
Outputs	Rated Output Capacity (kVA)	< 460 V <sup>*4</sup>	HD1	1.2	2.2	3.2	3.6	4.7	6.1	10	12	
			ND1	1.4	2.7	3.6	4.7	5.9	7.8	12	15	
		≥ 460 V <sup>*5</sup>	HD2	1.3	1.7	2.7	3.8	5.5	6.1	8.8	11	17
			ND2	1.7	2.4	3.8	5.5	6.1	8.8	11	17	
	Rated Output Current (A)	< 460 V	HD1	1.8	3.4	4.8	5.5	7.2	9.2	14.8	18	
			ND1	2.1	4.1	5.4	7.1	8.9	11.9	17.5	23.4	
		≥ 460 V	HD2	1.6	2.1	3.4	4.8	6.9	7.6	11	14	
			ND2	2.1	3	4.8	6.9	7.6	11	14	21	
	Overload Tolerance			<ul style="list-style-type: none"> <li>• HD: 150% of the rated output current for 60 seconds</li> <li>• ND: 110% of the rated output current for 60 seconds</li> </ul> <b>Note:</b> Derating may be necessary for applications that start and stop frequently.								
	Carrier Frequency			HD: 8 kHz without derating the drive capacity. ND: 2 kHz without derating the drive capacity. Derate the drive capacity to use values to 15 kHz maximum.								
	Maximum Output Voltage			Three-phase 380 V to 480 V <b>Note:</b> The maximum output voltage is proportional to the input voltage.								
	Maximum Output Frequency			<ul style="list-style-type: none"> <li>• Advanced Open Loop Vector Control (AOLV) and EZ Open Loop Vector Control (EZOLV): 120 Hz</li> <li>• Closed Loop V/f Control (CL-V/f), Closed Loop Vector Control (CLV), Advanced Open Loop Vector Control for PM (AOLV/PM), and Closed Loop Vector Control for PM (CLV/PM): 400 Hz</li> <li>• V/f Control (V/f), Open Loop Vector Control (OLV), and Open Loop Vector Control for PM (OLV/PM): 590 Hz</li> </ul>								
Measures for Harmonics	DC Reactor		External options									
Braking Device	Braking Transistor		Standard internal characteristics									
EMC Filter	EMC Filter IEC61800-3, C2/C3		Factory option <ul style="list-style-type: none"> <li>• Models 4xxxB: There is a category C3 EMC filter in the drive.</li> <li>• Models 4xxxC: There is a category C2 EMC filter in the drive.</li> </ul>									
Power Supply	Rated Voltage/Rated Frequency		<ul style="list-style-type: none"> <li>• Three-phase AC power supply 380 V to 480 V at 50/60 Hz</li> <li>• DC power supply 513 V to 679 V</li> </ul>									
	Permitted Voltage Fluctuation		-15% to +10%									
	Permitted Frequency Fluctuation		±5%									
	Input Power (kVA)	< 460 V	HD1	1.5	2.8	3.7	5.3	7.1	9.3	13	17	
			ND1	2.0	3.7	5.3	7.1	9.3	13	17	24	
≥ 460 V	HD2	1.3	1.7	3.2	4.6	6.1	7.5	11	15			
	ND2	2.1	4.0	5.6	7.5	9.1	13	18	26			

\*1 The maximum applicable motor output complies with 380 V motor ratings as specified in Annex G of IEC 60947-4-1. The rated output current of the drive output amps must be equal to or more than the motor rated current.

\*2 The maximum applicable motor output complies with 460 V motor ratings as specified in NEC Table 430.250. The rated output current of the drive output amps must be equal to or more than the motor rated current.

\*3 Assumes the value at the rated output current. The input current rating changes when the power supply transformer, input reactor, wiring connections, or power supply impedance change.

\*4 The rated output capacity is calculated with a rated output voltage of 380 V.

\*5 The rated output capacity is calculated with a rated output voltage of 460 V.

Table 9.6 Rating (400 V Class)

Model		Input Voltage	Duty Rating	4031	4038	4044	4060	4075	4089	4103	
Maximum Applicable Motor Output (kW)		< 460 V *1	HD1	11	15	18.5	22	30	37	45	
			ND1	15	18.5	22	30	37	45	55	
		≥ 460 V *2	HD2	11	15	18.5	22	30	37	45	45
			ND2	15	18.5	22	30	37	45	55	55
Maximum Applicable Motor Output (HP)		< 460 V *1	HD1	15	20	25	30	40	50	60	
			ND1	20	25	30	40	50	60	75	
		≥ 460 V *2	HD2	15	20	25	30	40	50	60	60
			ND2	20	25	30	40	50	60	75	75
Input	Rated Input Current (A) *3	< 460 V	HD1 (AC)	30.6	41.3	50.5	43.1	58.3	71.5	86.5	
			HD1 (DC)	38	51	62	53	72	88	106	
			ND1 (AC)	41.3	50.5	59.7	58.3	71.5	86.5	105	
			ND1 (DC)	51	62	74	72	88	106	129	
		≥ 460 V	HD2 (AC)	25.3	34.1	41.7	35.6	48.1	59.0	71.4	
			HD2 (DC)	31	42	52	44	59	73	88	
			ND2 (AC)	34.1	41.7	49.4	48.1	59.0	71.4	86.9	
			ND2 (DC)	42	52	61	59	73	88	107	
Outputs	Rated Output Capacity (kVA)	< 460 V *4	HD1	16	20	26	30	39	49	60	
			ND1	20	25	29	39	49	59	68	
		≥ 460 V *5	HD2	17	22	27	32	41	52	61	
			ND2	22	27	32	41	52	61	76	
	Rated Output Current (A)	< 460 V	HD1	24	31	39	45	60	75	91	
			ND1	31	38	44	59.6	74.9	89.2	103	
		≥ 460 V	HD2	21	27	34	40	52	65	77	
			ND2	27	34	40	52	65	77	96	
	Overload Tolerance			<ul style="list-style-type: none"> <li>HD: 150% of the rated output current for 60 seconds</li> <li>ND: 110% of the rated output current for 60 seconds</li> </ul> <b>Note:</b> Derating may be necessary for applications that start and stop frequently.							
	Carrier Frequency			HD: 8 kHz without derating the drive capacity. ND: 2 kHz without derating the drive capacity. Derate the drive capacity to use values to 15 kHz maximum.							
	Maximum Output Voltage			Three-phase 380 V to 480 V <b>Note:</b> The maximum output voltage is proportional to the input voltage.							
	Maximum Output Frequency			<ul style="list-style-type: none"> <li>Advanced Open Loop Vector Control (AOLV) and EZ Open Loop Vector Control (EZOLV): 120 Hz</li> <li>Closed Loop V/f Control (CL-V/f), Closed Loop Vector Control (CLV), Advanced Open Loop Vector Control for PM (AOLV/PM), and Closed Loop Vector Control for PM (CLV/PM): 400 Hz</li> <li>V/f Control (V/f), Open Loop Vector Control (OLV), and Open Loop Vector Control for PM (OLV/PM): 590 Hz</li> </ul>							
Measures for Harmonics	DC Reactor		External options				Standard internal characteristics				
Braking Device	Braking Transistor		Standard internal characteristics								

## 9.4 Model Specifications (400 V Class)

Model	Input Voltage	Duty Rating	4031	4038	4044	4060	4075	4089	4103
EMC Filter	EMC Filter IEC61800-3, C2/C3		Factory option <ul style="list-style-type: none"> <li>Models 4xxxB: There is a category C3 EMC filter in the drive.</li> <li>Models 4xxxC: There is a category C2 EMC filter in the drive.</li> </ul>						
Power Supply	Rated Voltage/Rated Frequency		<ul style="list-style-type: none"> <li>Three-phase AC power supply 380 V to 480 V at 50/60 Hz</li> <li>DC power supply 513 V to 679 V</li> </ul>						
	Permitted Voltage Fluctuation		-15% to +10%						
	Permitted Frequency Fluctuation		±5%						
	Input Power (kVA)	< 460 V	HD1	24	33	40	34	46	57
ND1			33	40	48	46	57	69	84
≥ 460 V		HD2	21	28	35	30	40	49	59
		ND2	35	42	50	49	60	73	88

- \*1 The maximum applicable motor output complies with 380 V motor ratings as specified in Annex G of IEC 60947-4-1. The rated output current of the drive output amps must be equal to or more than the motor rated current.
- \*2 The maximum applicable motor output complies with 460 V motor ratings as specified in NEC Table 430.250. The rated output current of the drive output amps must be equal to or more than the motor rated current.
- \*3 Assumes the value at the rated output current. The input current rating changes when the power supply transformer, input reactor, wiring connections, or power supply impedance change.
- \*4 The rated output capacity is calculated with a rated output voltage of 380 V.
- \*5 The rated output capacity is calculated with a rated output voltage of 460 V.

**Table 9.7 Rating (400 V Class)**

Model	Input Voltage	Duty Rating	4140	4168	4208	4250	4296	4371	4389	
Maximum Applicable Motor Output (kW)	< 460 V *1	HD1	55	75	90	110	132	160	200	
		ND1	75	90	110	132	160	200	220	
	≥ 460 V *2	HD2	55	75	90	110	150	185	220	
		ND2	75	90	110	150	185	220	260	
Maximum Applicable Motor Output (HP)	< 460 V *1	HD1	75	100	125	150	175	200	250	
		ND1	100	125	150	175	200	250	300	
	≥ 460 V *2	HD2	75	100	125	150	200	250	300	
		ND2	100	125	150	200	250	300	350	
Input	Rated Input Current *3 (A)	< 460 V	HD1 (AC)	105	142	170	207	248	300	373
			HD1 (DC)	129	174	209	254	304	367	457
			ND1 (AC)	142	170	207	248	300	373	410
			ND1 (DC)	174	209	254	304	367	457	502
		≥ 460 V	HD2 (AC)	86.9	118	141	171	232	289	346
			HD2 (DC)	107	144	172	210	284	354	424
			ND2 (AC)	118	141	171	232	289	346	403
			ND2 (DC)	144	172	210	284	354	424	494

Model		Input Voltage	Duty Rating	4140	4168	4208	4250	4296	4371	4389	
Outputs	Rated Output Capacity (kVA)	< 460 V *4	HD1	74	99	118	142	171	200	244	
			ND1	92	111	137	165	195	244	256	
		≥ 460 V *5	HD2	76	99	124	143	191	241	288	
			ND2	99	124	143	191	241	288	330	
	Rated Output Current (A)	< 460 V	HD1	112	150	180	216	260	304	371	
			ND1	140	168	208	250	296	371	389	
		≥ 460 V	HD2	96	124	156	180	240	302	361	
			ND2	124	156	180	240	302	361	414	
	Overload Tolerance			<ul style="list-style-type: none"> <li>HD: 150% of the rated output current for 60 seconds</li> <li>ND: 110% of the rated output current for 60 seconds</li> </ul> <b>Note:</b> Derating may be necessary for applications that start and stop frequently.							
	Carrier Frequency			HD: 5 kHz without derating the drive capacity. ND: 2 kHz without derating the drive capacity. Derate the drive capacity to use values to 10 kHz maximum.							
	Maximum Output Voltage			Three-phase 380 V to 480 V <b>Note:</b> The maximum output voltage is proportional to the input voltage.							
	Maximum Output Frequency			<ul style="list-style-type: none"> <li>Advanced Open Loop Vector Control (AOLV) and EZ Open Loop Vector Control (EZOLV): 120 Hz</li> <li>Closed Loop V/f Control (CL-V/f), Closed Loop Vector Control (CLV), Advanced Open Loop Vector Control for PM (AOLV/PM), and Closed Loop Vector Control for PM (CLV/PM): 400 Hz</li> <li>V/f Control (V/f), Open Loop Vector Control (OLV), and Open Loop Vector Control for PM (OLV/PM): 590 Hz</li> </ul>							
Measures for Harmonics	DC Reactor		Standard internal characteristics								
Braking Device	Braking Transistor		Standard internal characteristics				External options				
EMC Filter	EMC Filter IEC61800-3, C2/C3		Factory option <ul style="list-style-type: none"> <li>Models 4xxxB: There is a category C3 EMC filter in the drive.</li> <li>Models 4xxxC: There is a category C2 EMC filter in the drive.</li> </ul>								
Power Supply	Rated Voltage/Rated Frequency		<ul style="list-style-type: none"> <li>Three-phase AC power supply 380 V to 480 V at 50/60 Hz</li> <li>DC power supply 513 V to 679 V</li> </ul>								
	Permitted Voltage Fluctuation		-15% to +10%								
	Permitted Frequency Fluctuation		±5%								
	Input Power (kVA)	< 460 V	HD1	84	113	136	165	198	239	297	
			ND1	113	136	165	198	239	297	327	
Input Power (kVA)	≥ 460 V	HD2	72	98	117	142	193	240	288		
		ND2	120	143	174	236	295	352	410		

- \*1 The maximum applicable motor output complies with 380 V motor ratings as specified in Annex G of IEC 60947-4-1. The rated output current of the drive output amps must be equal to or more than the motor rated current.
- \*2 The maximum applicable motor output complies with 460 V motor ratings as specified in NEC Table 430.250. The rated output current of the drive output amps must be equal to or more than the motor rated current.
- \*3 Assumes the value at the rated output current. The input current rating changes when the power supply transformer, input reactor, wiring connections, or power supply impedance change.
- \*4 The rated output capacity is calculated with a rated output voltage of 380 V.
- \*5 The rated output capacity is calculated with a rated output voltage of 460 V.

Table 9.8 Rating (400 V Class)

Model		Input Voltage	Duty Rating	4453	4568	4675
Maximum Applicable Motor Output (kW)		< 460 V *1	HD1	220	250	315
			ND1	250	315	355
		≥ 460 V *2	HD2	260	300	335
			ND2	300	335	370
Maximum Applicable Motor Output (HP)		< 460 V *1	HD1	300	335	400
			ND1	335	400	450
		≥ 460 V *2	HD2	350	400	450
			ND2	400	450	500
Input	Rated Input Current *3(A)	< 460 V	HD1 (AC)	410	465	584
			HD1 (DC)	502	569	715
			ND1 (AC)	465	584	657
			ND1 (DC)	569	715	805
		≥ 460 V	HD2 (AC)	403	460	516
			HD2 (DC)	494	563	632
			ND2 (AC)	460	516	573
			ND2 (DC)	563	632	702
Outputs	Rated Output Capacity (kVA)	< 460 V *4	HD1	272	298	398
			ND1	298	374	444
		≥ 460 V *5	HD2	330	380	410
			ND2	380	410	482
	Rated Output Current (A)	< 460 V	HD1	414	453	605
			ND1	453	568	675
		≥ 460 V	HD2	414	477	515
			ND2	477	515	605
	Overload Tolerance	<ul style="list-style-type: none"> <li>• HD: 150% of the rated output current for 60 seconds</li> <li>• ND: 110% of the rated output current for 60 seconds</li> </ul> <b>Note:</b> Derating may be necessary for applications that start and stop frequently.				
	Carrier Frequency	HD: 2 kHz without derating the drive capacity. ND: 2 kHz without derating the drive capacity. Derate the drive capacity to use values to 5 kHz maximum.				
	Maximum Output Voltage	Three-phase 380 V to 480 V <b>Note:</b> The maximum output voltage is proportional to the input voltage.				
	Maximum Output Frequency	<ul style="list-style-type: none"> <li>• Advanced Open Loop Vector Control (AOLV) and EZ Open Loop Vector Control (EZOLV): 120 Hz</li> <li>• Closed Loop V/f Control (CL-V/f), Closed Loop Vector Control (CLV), Advanced Open Loop Vector Control for PM (AOLV/PM), and Closed Loop Vector Control for PM (CLV/PM): 400 Hz</li> <li>• V/f Control (V/f), Open Loop Vector Control (OLV), and Open Loop Vector Control for PM (OLV/PM): 590 Hz</li> </ul>				
Measures for Harmonics	DC Reactor	Standard internal characteristics				
Braking Device	Braking Transistor	External options				

Model		Input Voltage	Duty Rating	4453	4568	4675
EMC Filter	EMC Filter IEC61800-3, C2/C3		Factory option • Models 4xxxB: There is a category C3 EMC filter in the drive. • Models 4xxxC: There is a category C2 EMC filter in the drive.			
Power Supply	Rated Voltage/Rated Frequency		• Three-phase AC power supply 380 V to 480 V at 50/60 Hz • DC power supply 513 V to 679 V			
	Permitted Voltage Fluctuation		-15% to +10%			
	Permitted Frequency Fluctuation		±5%			
	Input Power (kVA)	< 460 V	HD1	327	370	465
			ND1	370	465	523
	≥ 460 V	HD2	335	382	429	
		ND2	468	526	584	

- \*1 The maximum applicable motor output complies with 380 V motor ratings as specified in Annex G of IEC 60947-4-1. The rated output current of the drive output amps must be equal to or more than the motor rated current.
- \*2 The maximum applicable motor output complies with 460 V motor ratings as specified in NEC Table 430.250. The rated output current of the drive output amps must be equal to or more than the motor rated current.
- \*3 Assumes the value at the rated output current. The input current rating changes when the power supply transformer, input reactor, wiring connections, or power supply impedance change.
- \*4 The rated output capacity is calculated with a rated output voltage of 380 V.
- \*5 The rated output capacity is calculated with a rated output voltage of 460 V.

## 9.5 Drive Specifications

**Note:**

- To get the OLV, CLV, and AOLV specifications, do Rotational Auto-Tuning.
- To get the longest product life, install the drive in an environment that meets the necessary specifications.

**Table 9.9 Control Characteristics**

Item	Specifications
Control Methods	<ul style="list-style-type: none"> <li>• V/f Control (V/f)</li> <li>• Closed Loop V/f Control (CL-V/f)</li> <li>• Open Loop Vector Control (OLV)</li> <li>• Closed Loop Vector Control (CLV)</li> <li>• Advanced Open Loop Vector Control (AOLV)</li> <li>• Open Loop Vector Control for PM (OLV/PM)</li> <li>• Advanced Open Loop Vector Control for PM (AOLV/PM)</li> <li>• Closed Loop Vector Control for PM (CLV/PM)</li> <li>• EZ Open Loop Vector Control (EZOLV)</li> </ul>
Frequency Control Range	<ul style="list-style-type: none"> <li>• AOLV and EZOLV: 0.01 Hz to 120 Hz</li> <li>• CL-V/f, CLV, AOLV/PM, and CLV/PM: 0.01 Hz to 400 Hz</li> <li>• V/f, OLV, and OLV/PM: 0.01 Hz to 590 Hz</li> </ul>
Frequency Accuracy (Temperature Fluctuation)	<p>Digital inputs: Within <math>\pm 0.01\%</math> of the maximum output frequency (<math>-10\text{ }^{\circ}\text{C}</math> to <math>+40\text{ }^{\circ}\text{C}</math> (<math>14\text{ }^{\circ}\text{F}</math> to <math>104\text{ }^{\circ}\text{F}</math>))</p> <p>Analog inputs: Within <math>\pm 0.1\%</math> of the maximum output frequency (<math>25\text{ }^{\circ}\text{C} \pm 10\text{ }^{\circ}\text{C}</math> (<math>77\text{ }^{\circ}\text{F} \pm 18\text{ }^{\circ}\text{F}</math>))</p>
Frequency Setting Resolution	<p>Digital inputs: 0.01 Hz</p> <p>Analog inputs: 1/2048 of the maximum output frequency (11-bit signed)</p>
Output Frequency Resolution	0.001 Hz
Frequency Setting Signal	<p>Main speed frequency reference: <math>-10\text{ Vdc}</math> to <math>+10\text{ Vdc}</math> (20 k<math>\Omega</math>), <math>0\text{ Vdc}</math> to <math>10\text{ Vdc}</math> (20 k<math>\Omega</math>), 4 mA to 20 mA (250 <math>\Omega</math>), 0 mA to 20 mA (250 <math>\Omega</math>)</p> <p>Main speed reference: Pulse train input (maximum 32 kHz)</p>
Starting Torque	<ul style="list-style-type: none"> <li>• V/f: 150%/3 Hz</li> <li>• CL-V/f: 150%/3 Hz</li> <li>• OLV: 200%/0.3 Hz</li> <li>• CLV: 200%/0 min<sup>-1</sup> (r/min)</li> <li>• AOLV: 200%/0.3 Hz</li> <li>• OLV/PM: 100%/5% speed</li> <li>• AOLV/PM: 200%/0 min<sup>-1</sup> (r/min)</li> <li>• CLV/PM: 200%/0 min<sup>-1</sup> (r/min)</li> <li>• EZOLV: 100%/1% speed</li> </ul> <p><b>Note:</b> Correctly select drive capacity for this starting torque in these control methods:</p> <ul style="list-style-type: none"> <li>•OLV</li> <li>•CLV</li> <li>•AOLV</li> <li>•AOLV/PM</li> <li>•CLV/PM</li> </ul>
Speed Control Range	<ul style="list-style-type: none"> <li>• V/f: 1:40</li> <li>• CL-V/f: 1:40</li> <li>• OLV: 1:200</li> <li>• CLV: 1:1500</li> <li>• AOLV: 1:200</li> <li>• OLV/PM: 1:20</li> <li>• AOLV/PM: 1:100 (when high frequency injection is enabled)</li> <li>• CLV/PM: 1:1500</li> <li>• EZOLV: 1:100</li> </ul>



Item	Specifications
Zero Speed Control	Possible in these control methods: <ul style="list-style-type: none"> <li>• CLV</li> <li>• AOLV/PM</li> <li>• CLV/PM</li> </ul>
Torque Limits	Parameter settings allow different limits in four quadrants in these control methods: <ul style="list-style-type: none"> <li>• OLV</li> <li>• CLV</li> <li>• AOLV</li> <li>• AOLV/PM</li> <li>• CLV/PM</li> <li>• EZOLV</li> </ul>
Accel/Decel Time	0.0 s to 6000.0 s The drive can set four pairs of different acceleration and deceleration times.
Braking Torque	<p>Approximately 20%</p> <p>Approximately 125% with a dynamic braking option</p> <ul style="list-style-type: none"> <li>• Short-time average deceleration torque Motor output 0.4/0.75 kW: over 100% Motor output 1.5 kW: over 50% Motor output 2.2 kW and larger: over 20%, Overexcitation Braking/High Slip Braking allow for approximately 40%</li> <li>• Continuous regenerative torque: Approximately 20%. Dynamic braking option allows for approximately 125%, 10% ED, 10 s</li> </ul> <p><b>WARNING!</b> Set L3-04 = 0 [Stall Prevention during Decel = Disabled] when operating the drive with:</p> <ul style="list-style-type: none"> <li>• a regenerative converter</li> <li>• regenerative unit</li> <li>• braking unit</li> <li>• braking resistor</li> <li>• braking resistor unit.</li> </ul> <p>Failure to obey could prevent the drive from stopping in the specified deceleration time and cause serious injury or death.</p> <p><b>Note:</b></p> <ul style="list-style-type: none"> <li>• Models 2004 to 2138 and 4002 to 4168 have a braking transistor.</li> <li>• Short-time average deceleration torque refers to the torque needed to decelerate the motor (uncoupled from the load) from the rated speed to zero. Motor characteristics can change the actual specifications.</li> <li>• Motor characteristics change the continuous regenerative torque and short-time average deceleration torque for motors 2.2 kW and larger.</li> </ul>
V/f Characteristics	Select from 15 pre-defined V/f patterns, or a user-set V/f pattern.
Main Control Functions	Torque Control, Droop Control, Speed/Torque Control Switching, Feed Forward Control, Zero Servo Function, Restart After Momentary Power Loss, Speed Search, Overtorque/Undertorque Detection, Torque Limit, 17 Step Speed (max.), Accel/Decel Switch, S-curve Acceleration/Deceleration, 3-wire Sequence, Auto-Tuning (Rotational and Stationary), Dwell Function, Cooling Fan ON/OFF Switch, Slip Compensation, Torque Compensation, Frequency Jump, Upper/Lower Limits for Frequency Reference, DC Injection Braking at Start and Stop, Overexcitation Braking, High Slip Braking, PID Control (with Sleep Function), Energy Saving Control, MEMOBUS/Modbus Communication (RS-485 max, 115.2 kbps), Auto Restart, Application Presets, DriveWorksEZ (customized functions), Removable Terminal Block with Parameter Backup Function, Online Tuning, KEB, Overexcitation Deceleration, Inertia (ASR) Tuning, Overvoltage Suppression, High Frequency Injection

Table 9.10 Protection Functions

Item	Specifications
Motor Protection	Electronic thermal overload protection
Momentary Overcurrent Protection	Drive stops when the output current is more than 200% of the HD output current.
Overload Protection	Drive stops when the output current is more than 150% of the HD output current for 60 seconds. <b>Note:</b> The drive can trigger the overload protection function at 150% of the drive rated output in less than 60 s if the output frequency is less than 6 Hz.
Overvoltage Protection	200 V class: Stops when the DC bus voltage is more than approximately 410 V 400 V class: Stops when the DC bus voltage is more than approximately 820 V
Undervoltage Protection	200 V class: Stops when the DC bus voltage decreases to less than approximately 190 V 400 V class: Stops when the DC bus voltage decreases to less than approximately 380 V

## 9.5 Drive Specifications

Item	Specifications
Momentary Power Loss Ride-thru	Stops when power loss is longer than 15 ms. Continues operation if power loss is shorter than 2 s (depending on parameter settings). <b>Note:</b> • Stop time may be shortened depending on the load and motor speed. • Drive capacity will change the continuous operation time. A Momentary Power Loss Recovery Unit is necessary to continue operation through a 2 s power loss on models 2004 to 2056 and 4002 to 4031.
Heatsink Overheat Protection	Thermistor
Braking Resistor Overheat Protection	Overheat detection for braking resistor (optional ERF-type, 3% ED)
Stall Prevention	Stall prevention is available during acceleration, deceleration, and during run.
Ground Fault Protection	Electronic circuit protection <b>Note:</b> This protection detects ground faults during run. The drive will not provide protection when: • There is a low-resistance ground fault for the motor cable or terminal block • Energizing the drive when there is a ground fault.
DC Bus Charge LED	Charge LED illuminates when DC bus voltage is more than 50 V.

**Table 9.11 Environment**

Environment	Conditions
Area of Use	Indoors
Power Supply	Overvoltage Category III
Ambient Temperature	Open chassis type (IP20): -10°C to +50 °C (14 °F to 122 °F) Enclosed wall-mounted type (UL Type 1): -10 °C to +40 °C (14 °F to 104 °F) • Drive reliability is better in environments that do not have wide temperature fluctuations. • When installing the drive in an enclosure, use a cooling fan or air conditioner to keep the internal air temperature in the permitted range. • Do not let the drive freeze. • To install the drive in areas with ambient temperatures 40 °C to 60 °C (104 °F to 140 °F), derate the output current and output voltage.
Humidity	95% RH or less Do not let condensation form on the drive.
Storage Temperature	-20 °C to +70 °C (-4 °F to +158 °F) (short-term temperature during transportation)
Surrounding Area	Pollution degree 2 or less Install the drive in an area without: • Oil mist, corrosive or flammable gas, or dust • Metal powder, oil, water, or other unwanted materials • Radioactive materials or flammable materials, including wood • Harmful gas or fluids • Salt • Direct sunlight
Altitude	1000 m (3281 ft.) maximum <b>Note:</b> Derate the output current by 1% for each 100 m (328 ft.) to install the drive in altitudes between 1000 m to 3000 m (3281 ft. to 9843 ft.). It is not necessary to derate the rated voltage in these conditions: • Installing the drive at 2000 m (6562 ft.) or lower • Installing the drive between 2000 m to 3000 m (6562 ft. to 9843 ft.) and grounding the neutral point on the power supply. Contact Yaskawa or your nearest sales representative when not grounding the neutral point.

Environment	Conditions
Vibration	<ul style="list-style-type: none"> <li>• 10 Hz to 20 Hz: 1 G (9.8 m/s<sup>2</sup>, 32.15 ft/s<sup>2</sup>)</li> <li>• 20 Hz to 55 Hz: 2004 to 2211, 4002 to 4168: 0.6 G (5.9 m/s<sup>2</sup>, 19.36 ft/s<sup>2</sup>) 2257 to 2415, 4208 to 4675: 0.2 G (2.0 m/s<sup>2</sup>, 6.56 ft/s<sup>2</sup>)</li> </ul>
Installation Orientation	Install the drive vertically for sufficient airflow to cool the drive.

Table 9.12 Standard

Item	Specifications
Harmonized Standard	<ul style="list-style-type: none"> <li>• UL61800-5-1</li> <li>• EN61800-3</li> <li>• IEC/EN61800-5-1</li> <li>• Two Safe Disable inputs and one EDM output according to ISO/EN13849-1 Cat.III PL<sub>e</sub>, IEC/EN61508 SIL3</li> </ul>
Protection Design	<p>Open-chassis type (IP20) Enclosed wall-mounted type (UL Type 1)</p> <p><b>Note:</b> Install a UL Type 1 kit on an open-chassis type (IP20) drive to convert the drive to a wall-mount enclosure (UL Type 1).</p>

## 9.6 Drive Derating

You must derate the drive capacity to operate the drive above the rated temperature, altitude, and default carrier frequency.

### ◆ Carrier Frequency Settings and Rated Current Values

Table 9.13, Table 9.15, and Table 9.16 show how the drive rated output current changes when the *C6-02 [Carrier Frequency Selection]* value changes. The output current value changes linearly as the carrier frequency changes. You can use the values from the tables to calculate a frequency that is not shown. When *A1-02 = 6 [Control Method Selection = PM Advanced Open Loop Vector]*, refer to Table 9.14, Table 9.17, and Table 9.18.

#### ■ 200 V Class

Table 9.13 Carrier Frequency and Rated Current Derating

Model	Rated Current (A)											
	Heavy Duty Rating (HD1)						Normal Duty Rating (ND1)					
	2 kHz	5 kHz	8 kHz	10 kHz	12.5 kHz	15 kHz	2 kHz	5 kHz	8 kHz	10 kHz	12.5 kHz	15 kHz
2004	3.2	3.2	3.2	3.1	2.9	2.78	3.5	3.3	2.9	2.7	2.4	2.10
2006	5.0	5.0	5.0	4.8	4.6	4.3	6	5.6	5	4.6	4.1	3.6
2010	8.0	8.0	8.0	7.4	6.6	5.8	9.6	9.0	8	7.4	6.6	5.8
2012	11.0	11.0	11.0	10.4	9.6	8.8	12	11.7	11	10.5	9.9	9.3
2018	14.0	14.0	14.0	12.6	10.8	9.1	17.5	16.1	14	12.6	10.8	9.1
2021	17.5	17.5	17.5	16.1	14.3	12.6	21	19.6	17	16.1	14.3	12.5
2030	25.0	25.0	25.0	23.0	20.5	18.0	30	28.0	25	23.0	20.5	18.0
2042	33.0	33.0	33.0	29.3	24.8	20.2	42	38.4	33	29.4	24.9	20.4
2056	47.0	47.0	47.0	43.4	38.9	34.4	56	52.4	47	43.4	38.9	34.4
2070	60.0	60.0	60.0	56.0	51.0	46	70	66.0	60	56.0	51.0	46.0
2082	75.0	75.0	75.0	68.6	60.5	53	82	82.0	75	68.8	61.0	53.1
2110	88.0	88.0	88.0	80.5	71.0	62	110	102.7	92	84.3	75.2	66.0
2138	115.0	115.0	115.0	105.1	92.8	81	138	128.8	115	105.8	94.3	82.8
2169	145.0	145.0	125.2	112.0	-	-	169	152.7	128.3	112.0	-	-
2211	180.0	180.0	155.2	138.6	-	-	211	190.2	158.9	138.1	-	-
2257	215.0	215.0	184.8	164.7	-	-	257	230.4	190.5	163.9	-	-
2313	283.0	283.0	249.0	226.4	-	-	313	288.5	251.7	227.1	-	-
2360	346.0	346.0	294.3	259.8	-	-	360	330.8	287.6	258.8	-	-
2415	415.0	415.0	365.2	332.0	-	-	-	-	-	-	-	-

Table 9.14 AOLV/PM Carrier Frequency and Rated Current Derating

Model	Rated Current (A)											
	Heavy Duty Rating (HD1)						Normal Duty Rating (ND1)					
	2 kHz	4 kHz	6 kHz	8 kHz	10 kHz	12 kHz	2 kHz	4 kHz	6 kHz	8 kHz	10 kHz	12 kHz
2004	3.2	3.2	3.1	3.0	2.8	2.6	3.5	3.1	2.8	2.4	2.1	1.7
2006	5.0	5.0	4.9	4.6	4.3	4.1	6.0	5.4	4.8	4.2	3.6	3.0
2010	8.0	8.0	7.7	6.7	5.8	4.8	9.6	8.6	7.7	6.7	5.8	4.8
2012	11.0	11.0	10.7	9.8	8.8	7.9	12.2	11.5	10.7	10.0	9.3	8.6
2018	14.0	14.0	13.3	11.2	9.1	6.9	17.5	15.4	13.3	11.2	9.1	6.9
2021	17.5	17.5	16.8	14.7	12.6	10.4	21.0	18.9	16.8	14.6	12.5	10.4
2030	25.0	25.0	24.0	21.0	18.0	15.0	30.0	27.0	24.0	21.0	18.0	15.0

Model	Rated Current (A)											
	Heavy Duty Rating (HD1)						Normal Duty Rating (ND1)					
	2 kHz	4 kHz	6 kHz	8 kHz	10 kHz	12 kHz	2 kHz	4 kHz	6 kHz	8 kHz	10 kHz	12 kHz
2042	33.0	33.0	31.2	25.7	20.2	14.7	42.0	36.6	31.2	25.8	20.4	15.0
2056	47.0	47.0	45.2	39.8	34.4	29.0	56.0	50.6	45.2	39.8	34.4	29.0
2070	60.0	60.0	58.0	52.0	46.0	40.0	70.0	64.0	58.0	52.0	46.0	40.0
2082	75.0	75.0	71.8	62.1	52.5	42.9	82.0	81.4	72.0	62.6	53.1	43.7
2110	88.0	88.0	84.2	72.9	61.6	50.3	110.0	99.0	88.0	77.0	66.0	55.0
2138	115.0	115.0	110.1	95.3	80.5	65.7	138.0	124.2	110.4	96.6	82.8	69.0
2169	145.0	138.4	118.6	98.8	78.9	-	169.0	144.6	120.1	95.7	71.2	-
2211	180.0	171.7	146.9	122.0	97.2	-	211.0	179.7	148.5	117.2	86.0	-
2257	215.0	204.9	174.7	144.5	114.3	-	257.0	217.1	177.2	137.3	97.4	-
2313	283.0	271.7	237.7	203.8	169.8	-	313.0	276.2	239.4	202.6	165.8	-
2360	346.0	328.8	277.0	225.3	173.6	-	359.6	316.4	273.2	230.0	186.8	-
2415	415.0	398.4	348.6	298.8	249.0	-	-	-	-	-	-	-

## ■ 400 V Class

Table 9.15 Carrier Frequency and Rated Current Derating (< 460 V)

Model	Rated Current (A)											
	Heavy Duty Rating (HD1)						Normal Duty Rating (ND1)					
	2 kHz	5 kHz	8 kHz	10 kHz	12.5 kHz	15 kHz	2 kHz	5 kHz	8 kHz	10 kHz	12.5 kHz	15 kHz
4002	1.8	1.8	1.8	1.6	1.3	1.0	2.1	2.0	1.8	1.7	1.5	1.4
4004	3.4	3.4	3.4	2.9	2.3	1.7	4.1	3.8	3.4	3.1	2.8	2.4
4005	4.8	4.8	4.8	4.3	3.7	3.0	5.4	5.2	4.8	4.6	4.3	3.9
4007	5.5	5.5	5.5	4.9	4.1	3.2	7.1	6.5	5.5	4.8	4.0	3.2
4009	7.2	7.2	7.2	6.5	5.6	4.8	8.9	8.2	7.2	6.5	5.6	4.8
4012	9.2	9.2	9.2	8.1	6.8	5.4	11.9	10.8	9.2	8.1	6.7	5.4
4018	14.8	14.8	14.8	13.1	11.0	8.9	17.5	17.3	14.8	13.1	11.0	8.9
4023	18.0	18.0	18.0	15.9	13.4	10.8	23	21.5	18.3	16.2	13.6	11.0
4031	24.0	24.0	24.0	21.2	17.7	14.1	31	28.2	24.0	21.1	17.6	14.1
4038	31.0	31.0	31.0	27.5	23.0	18.6	38	36.3	31.0	27.5	23.0	18.6
4044	39.0	39.0	39.0	34.5	29.0	23.4	44	43.6	37.5	33.5	28.4	23.4
4060	45.0	45.0	45.0	39.1	31.8	24.4	60	53.7	44.9	39.1	31.7	24
4075	60.0	60.0	60.0	53.1	44.6	36.0	75	73.8	62.9	55.6	46.5	37
4089	75.0	75.0	75.0	66.4	55.7	45.0	89	88.8	75.8	67.2	56.4	46
4103	91.0	91.0	91.0	80.6	67.6	54.6	103	103.0	90.3	80.1	67.3	55
4140	112.0	112.0	91.8	78.4	-	-	140	122.8	96.7	79	-	-
4168	150.0	150.0	123.0	105.0	-	-	168	150.5	124.4	107	-	-
4208	180.0	180.0	147.6	126.0	-	-	208	179.7	137.2	109	-	-
4250	216.0	216.0	177.1	151.2	-	-	250	221.8	179.4	151	-	-
4296	260.0	260.0	213.2	182.0	-	-	296	263.4	214.6	182	-	-
4371	304.0	304.0	249.3	212.8	-	-	371	327.2	261.6	218	-	-
4389	371.0	371.0	304.2	259.7	-	-	389	348	286.3	245	-	-
4453	389.0	324.8	-	-	-	-	453	349	-	-	-	-

## 9.6 Drive Derating

Model	Rated Current (A)											
	Heavy Duty Rating (HD1)						Normal Duty Rating (ND1)					
	2 kHz	5 kHz	8 kHz	10 kHz	12.5 kHz	15 kHz	2 kHz	5 kHz	8 kHz	10 kHz	12.5 kHz	15 kHz
4568	453.0	378.3	-	-	-	-	568	437	-	-	-	-
4675	605.0	505.2	-	-	-	-	675	529	-	-	-	-

**Table 9.16 Carrier Frequency and Rated Current Derating ( $\geq 460$  V)**

Model	Rated Current (A)											
	Heavy Duty Rating (HD2)						Normal Duty Rating (ND2)					
	2 kHz	5 kHz	8 kHz	10 kHz	12.5 kHz	15 kHz	2 kHz	5 kHz	8 kHz	10 kHz	12.5 kHz	15 kHz
4002	2.1	1.9	1.6	1.4	1.1	0.9	2.1	2.0	1.8	1.7	1.5	1.4
4004	2.8	2.5	2.1	1.8	1.4	1.1	3.0	2.8	2.5	2.3	2.0	1.8
4005	4.3	3.9	3.4	3.0	2.6	2.2	4.8	4.6	4.3	4.0	3.8	3.5
4007	6.2	5.6	4.8	4.2	3.5	2.8	6.9	6.3	5.3	4.7	3.9	3.2
4009	8.6	7.9	6.9	6.2	5.4	4.6	7.6	7.0	6.1	5.5	4.8	4.1
4012	9.8	8.9	7.6	6.7	5.6	4.5	11.0	10.0	8.5	7.5	6.2	5.0
4018	14.1	12.9	11.0	9.7	8.2	6.6	15.2	13.9	11.8	10.5	8.8	7.1
4023	18.0	16.4	14.0	12.4	10.4	8.4	21	19.3	16.4	14.6	12.2	9.9
4031	27.2	24.7	21.0	18.5	15.4	12.4	27	24.5	20.9	18.4	15.4	12.3
4038	34.7	31.6	27.0	23.9	20.1	16.2	34	32.5	27.7	24.6	20.6	16.6
4044	34.0	34.0	34.0	30.1	25.3	20.4	40	39.6	34.1	30.5	25.9	21.3
4060	40.0	40.0	40.0	34.8	28.3	21.7	52	46.9	39.2	34.1	27.7	21
4075	52.0	52.0	52.0	46.1	38.6	31.2	65	64.1	54.6	48.3	40.4	33
4089	65.0	65.0	65.0	57.6	48.3	39.0	77	76.6	65.5	58.0	48.7	39
4103	77.0	77.0	77.0	68.2	57.2	46.2	96	96.0	84.1	74.6	62.8	51
4140	96.0	96.0	78.7	67.2	-	-	124	108.7	85.7	70	-	-
4168	124.0	124.0	101.7	86.8	-	-	156	139.8	115.5	99	-	-
4208	156.0	156.0	127.9	109.2	-	-	180	155.5	118.7	94	-	-
4250	180.0	180.0	147.6	126.0	-	-	240	212.9	172.3	145	-	-
4296	240.0	240.0	196.8	168.0	-	-	302	268.8	218.9	186	-	-
4371	302.0	302.0	247.6	211.4	-	-	361	318.5	254.7	212	-	-
4389	361.0	361.0	296.0	252.7	-	-	414	370	303.3	259	-	-
4453	414.0	345.0	-	-	-	-	477	367	-	-	-	-
4568	477.0	397.5	-	-	-	-	515	397	-	-	-	-
4675	-	-	-	-	-	-	-	-	-	-	-	-

**Table 9.17 AOLV/PM Carrier Frequency and Rated Current Derating (< 460 V)**

Model	Rated Current (A)											
	Heavy Duty Rating (HD1)						Normal Duty Rating (ND1)					
	2 kHz	4 kHz	6 kHz	8 kHz	10 kHz	12 kHz	2 kHz	4 kHz	6 kHz	8 kHz	10 kHz	12 kHz
4002	1.8	1.8	1.7	1.3	1.0	0.6	2.1	1.9	1.7	1.6	1.4	1.2
4004	3.4	3.4	3.2	2.4	1.7	1.0	4.1	3.7	3.3	2.8	2.4	2.0
4005	4.8	4.8	4.5	3.8	3.0	2.3	5.4	5.0	4.7	4.3	3.9	3.6
4007	5.5	5.5	5.2	4.2	3.2	2.3	7.1	6.1	5.2	4.2	3.2	2.3
4009	7.2	7.2	6.9	5.8	4.8	3.8	8.9	7.9	6.8	5.8	4.8	3.7

Model	Rated Current (A)											
	Heavy Duty Rating (HD1)						Normal Duty Rating (ND1)					
	2 kHz	4 kHz	6 kHz	8 kHz	10 kHz	12 kHz	2 kHz	4 kHz	6 kHz	8 kHz	10 kHz	12 kHz
4012	9.2	9.2	8.7	7.0	5.4	3.8	11.9	10.3	8.6	7.0	5.4	3.8
4018	14.8	14.8	14.0	11.4	8.9	6.3	17.5	16.5	14.0	11.4	8.9	6.3
4023	18.0	18.0	17.0	13.9	10.8	7.7	23.4	20.4	17.3	14.1	11.0	7.8
4031	24.0	24.0	22.6	18.4	14.1	9.9	31.0	26.8	22.6	18.3	14.1	9.9
4038	31.0	31.0	29.2	23.9	18.6	13.3	38.0	34.5	29.2	23.9	18.6	13.3
4044	39.0	39.0	36.8	30.1	23.4	16.7	44.0	41.6	35.5	29.5	23.4	17.3
4060	45.0	45.0	42.1	33.3	24.4	15.6	59.6	50.8	42.0	33.2	24.4	15.6
4075	60.0	60.0	56.6	46.3	36.0	25.7	74.9	70.2	59.3	48.4	37.5	26.5
4089	75.0	75.0	70.7	57.9	45.0	32.1	89.2	84.5	71.5	58.6	45.6	32.7
4103	91.0	91.0	85.8	70.2	54.6	39.0	103.0	100.5	85.2	69.9	54.6	39.3
4140	112.0	105.3	85.1	65.0	44.8	-	140.0	114.1	88.1	62.0	36.0	-
4168	150.0	141.0	114.0	87.0	60.0	-	168.0	141.8	115.6	89.5	63.3	-
4208	180.0	169.2	136.8	104.4	72.0	-	208.0	165.5	123.1	80.6	38.1	-
4250	216.0	203.0	164.2	125.3	86.4	-	250.0	207.7	165.3	123.0	80.6	-
4296	260.0	244.4	197.6	150.8	104.0	-	296.0	247.1	198.3	149.4	100.6	-
4371	304.0	285.8	231.0	176.3	121.6	-	371.0	305.3	239.7	174.0	108.3	-
4389	371.0	348.7	282.0	215.2	148.4	-	389.0	327.5	265.7	203.8	142.0	-
4453	389.0	292.5	-	-	-	-	453.0	296.7	-	-	-	-
4568	453.0	340.7	-	-	-	-	568.0	372.0	-	-	-	-
4675	605.0	455.0	-	-	-	-	675.0	455.0	-	-	-	-

Table 9.18 AOLV/PM Carrier Frequency and Rated Current Derating ( $\geq 460$  V)

Model	Rated Current (A)											
	Heavy Duty Rating (HD2)						Normal Duty Rating (ND2)					
	2 kHz	4 kHz	6 kHz	8 kHz	10 kHz	12 kHz	2 kHz	4 kHz	6 kHz	8 kHz	10 kHz	12 kHz
4002	2.1	1.8	1.5	1.2	0.9	0.6	2.1	1.9	1.7	1.6	1.4	1.2
4004	2.8	2.4	2.0	1.5	1.1	0.6	3.0	2.7	2.4	2.1	1.8	1.5
4005	4.3	3.8	3.2	2.7	2.2	1.6	4.8	4.5	4.2	3.8	3.5	3.2
4007	6.2	5.4	4.5	3.7	2.8	2.0	6.9	6.0	5.0	4.1	3.2	2.2
4009	8.6	7.6	6.6	5.6	4.6	3.6	7.6	6.7	5.8	5.0	4.1	3.2
4012	9.8	8.5	7.2	5.8	4.5	3.1	11.0	9.5	8.0	6.5	5.0	3.5
4018	14.1	12.3	10.4	8.5	6.6	4.7	15.2	13.2	11.2	9.1	7.1	5.1
4023	18.0	15.6	13.2	10.8	8.4	6.0	21.0	18.3	15.5	12.7	9.9	7.0
4031	27.2	23.5	19.8	16.1	12.4	8.7	27.0	23.3	19.6	16.0	12.3	8.6
4038	34.7	30.1	25.5	20.8	16.2	11.6	34.0	30.9	26.2	21.4	16.6	11.9
4044	34.0	34.0	32.1	26.2	20.4	14.6	40.0	37.8	32.3	26.8	21.3	15.8
4060	40.0	40.0	37.4	29.6	21.7	13.9	52.0	44.3	36.7	29.0	21.3	13.6
4075	52.0	52.0	49.0	40.1	31.2	22.3	65.0	60.9	51.4	42.0	32.5	23.0
4089	65.0	65.0	61.3	50.1	39.0	27.9	77.0	72.9	61.7	50.6	39.4	28.2
4103	77.0	77.0	72.6	59.4	46.2	33.0	96.0	93.6	79.4	65.1	50.9	36.6
4140	96.0	90.2	73.0	55.7	38.4	-	124.0	101.1	78.0	54.9	31.9	-
4168	124.0	116.6	94.2	71.9	49.6	-	156.0	131.7	107.4	83.1	58.8	-

## 9.6 Drive Derating

Model	Rated Current (A)											
	Heavy Duty Rating (HD2)						Normal Duty Rating (ND2)					
	2 kHz	4 kHz	6 kHz	8 kHz	10 kHz	12 kHz	2 kHz	4 kHz	6 kHz	8 kHz	10 kHz	12 kHz
4208	156.0	146.6	118.6	90.5	62.4	-	180.0	143.2	106.5	69.7	33.0	-
4250	180.0	169.2	136.8	104.4	72.0	-	240.0	199.4	158.7	118.1	77.4	-
4296	240.0	225.6	182.4	139.2	96.0	-	302.0	252.2	202.3	152.5	102.6	-
4371	302.0	283.9	229.5	175.2	120.8	-	361.0	297.2	233.5	169.7	105.9	-
4389	361.0	339.3	274.4	209.4	144.4	-	414.0	347.6	281.1	214.7	148.3	-
4453	414.0	310.5	-	-	-	-	477.0	312.6	-	-	-	-
4568	477.0	357.8	-	-	-	-	515.0	337.5	-	-	-	-
4675	-	-	-	-	-	-	-	-	-	-	-	-

### ◆ Altitude Derating

Install the drive in a location that with an altitude of 1000 m (3281 ft.) or lower.

Derate the output current by 1% for each 100 m (328 ft.) to install the drive in altitudes between 1000 m to 3000 m (3281 ft. to 9843 ft.).

It is not necessary to derate the rated voltage in these conditions:

- Installing the drive at 2000 m (6562 ft.) or lower
- Installing the drive between 2000 m to 3000 m (6562 ft. to 9843 ft.) and grounding the neutral point on the power supply.  
Contact Yaskawa or your nearest sales representative when the drive is not grounded with the neutral network.



## 9.7 Drive Exterior and Mounting Dimensions

### ◆ Drive Models and Exterior/Mounting Dimensions

Table 9.19 Three-Phase 200 V

Model	Open-Chassis enclosure (IP20)	Enclosed wall-mounted type (UL Type 1)
2004 - 2042	466	476
2056	468	478
2070, 2082	469	479
2110	470	480
2138	471	481
2169, 2211	472	482
2257, 2313	473	483
2360	474	484
2415	474	-

Table 9.20 Three-Phase 400 V

Model	Open-Chassis enclosure (IP20)	Enclosed wall-mounted type (UL Type 1)
4002 - 4023	466	476
4031, 4038	468	478
4044 - 4060	469	479
4075	470	480
4089, 4103	471	481
4140, 4168	472	482
4208 - 4296	473	483
4371	474	484
4389	474	-
4453 - 4675	475	-

◆ Open Chassis Type (IP20)

■ 2004 to 2042, 4002 to 4023

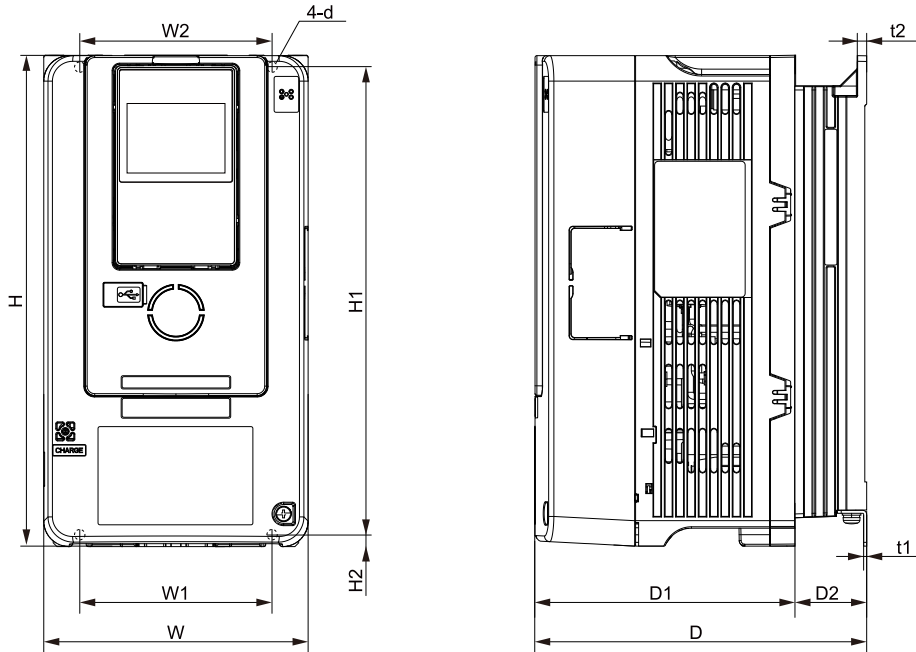


Figure 9.1 Exterior and Mounting Dimensions Diagram 1

Table 9.21 200 V class (IP20)

Model	Dimensions mm (in.)												Estimated Weight kg (lb.)
	W	H	D	D1	D2	W1	W2	H1	H2	t1	t2	d	
2004	140 (5.51)	260 (10.24)	176 (6.93)	138 (5.43)	38 (1.50)	102 (4.02)	102 (4.02)	248 (9.76)	6 (0.236)	1.6 (0.063)	5 (0.197)	M5	3.5 (7.72)
2006	140 (5.51)	260 (10.24)	176 (6.93)	138 (5.43)	38 (1.50)	102 (4.02)	102 (4.02)	248 (9.76)	6 (0.236)	1.6 (0.063)	5 (0.197)	M5	3.5 (7.72)
2010	140 (5.51)	260 (10.24)	176 (6.93)	138 (5.43)	38 (1.50)	102 (4.02)	102 (4.02)	248 (9.76)	6 (0.236)	1.6 (0.063)	5 (0.197)	M5	3.5 (7.72)
2012	140 (5.51)	260 (10.24)	176 (6.93)	138 (5.43)	38 (1.50)	102 (4.02)	102 (4.02)	248 (9.76)	6 (0.236)	1.6 (0.063)	5 (0.197)	M5	3.5 (7.72)
2018	140 (5.51)	260 (10.24)	211 (8.31)	138 (5.43)	73 (2.87)	102 (4.02)	102 (4.02)	248 (9.76)	6 (0.236)	1.6 (0.063)	5 (0.197)	M5	3.9 (8.60)
2021	140 (5.51)	260 (10.24)	211 (8.31)	138 (5.43)	73 (2.87)	102 (4.02)	102 (4.02)	248 (9.76)	6 (0.236)	1.6 (0.063)	5 (0.197)	M5	3.9 (8.60)
2030	140 (5.51)	260 (10.24)	211 (8.31)	138 (5.43)	73 (2.87)	102 (4.02)	102 (4.02)	248 (9.76)	6 (0.236)	1.6 (0.063)	5 (0.197)	M5	4.2 (9.26)
2042	140 (5.51)	260 (10.24)	211 (8.31)	138 (5.43)	73 (2.87)	102 (4.02)	102 (4.02)	248 (9.76)	6 (0.236)	1.6 (0.063)	5 (0.197)	M5	4.2 (9.26)

Table 9.22 400 V class (IP20)

Model	Dimensions mm (in.)												Estimated Weight kg (lb.)
	W	H	D	D1	D2	W1	W2	H1	H2	t1	t2	d	
4002	140 (5.51)	260 (10.24)	176 (6.93)	138 (5.43)	38 (1.50)	102 (4.02)	102 (4.02)	248 (9.76)	6 (0.236)	1.6 (0.063)	5 (0.197)	M5	3.5 (7.72)
4004	140 (5.51)	260 (10.24)	176 (6.93)	138 (5.43)	38 (1.50)	102 (4.02)	102 (4.02)	248 (9.76)	6 (0.236)	1.6 (0.063)	5 (0.197)	M5	3.5 (7.72)

Model	Dimensions mm (in.)												Estimated Weight kg (lb.)
	W	H	D	D1	D2	W1	W2	H1	H2	t1	t2	d	
4005	140 (5.51)	260 (10.24)	176 (6.93)	138 (5.43)	38 (1.50)	102 (4.02)	102 (4.02)	248 (9.76)	6 (0.236)	1.6 (0.063)	5 (0.197)	M5	3.5 (7.72)
4007	140 (5.51)	260 (10.24)	211 (8.31)	138 (5.43)	73 (2.87)	102 (4.02)	102 (4.02)	248 (9.76)	6 (0.236)	1.6 (0.063)	5 (0.197)	M5	3.9 (8.60)
4009	140 (5.51)	260 (10.24)	211 (8.31)	138 (5.43)	73 (2.87)	102 (4.02)	102 (4.02)	248 (9.76)	6 (0.236)	1.6 (0.063)	5 (0.197)	M5	3.9 (8.60)
4012	140 (5.51)	260 (10.24)	211 (8.31)	138 (5.43)	73 (2.87)	102 (4.02)	102 (4.02)	248 (9.76)	6 (0.236)	1.6 (0.063)	5 (0.197)	M5	3.9 (8.60)
4018	140 (5.51)	260 (10.24)	211 (8.31)	138 (5.43)	73 (2.87)	102 (4.02)	102 (4.02)	248 (9.76)	6 (0.236)	1.6 (0.063)	5 (0.197)	M5	4.2 (9.26)
4023	140 (5.51)	260 (10.24)	211 (8.31)	138 (5.43)	73 (2.87)	102 (4.02)	102 (4.02)	248 (9.76)	6 (0.236)	1.6 (0.063)	5 (0.197)	M5	4.2 (9.26)

■ 2056, 4031, 4038

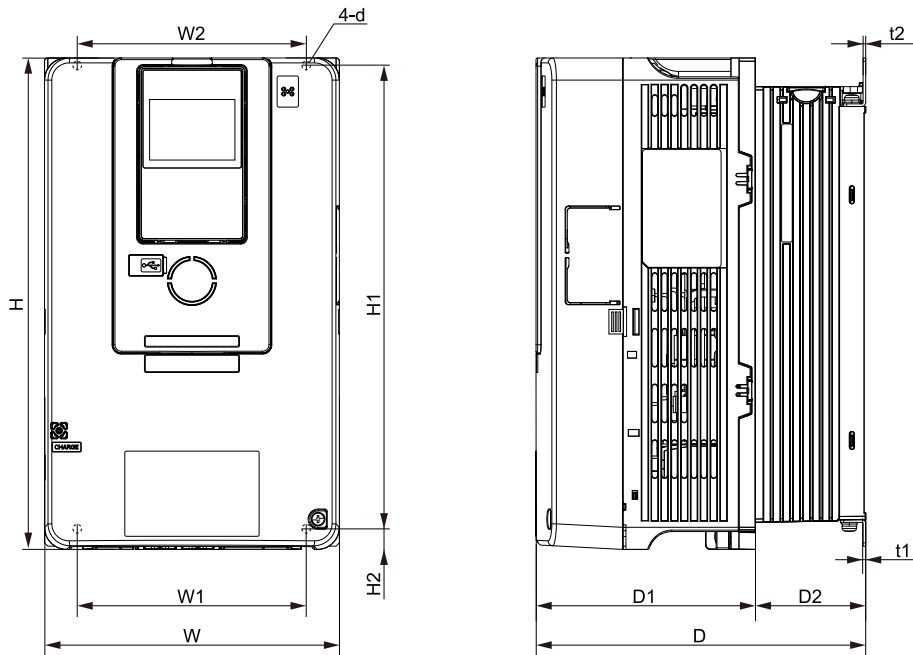


Figure 9.2 Exterior and Mounting Dimensions Diagram 2

Table 9.23 200 V class (IP20)

Model	Dimensions mm (in.)												Estimated Weight kg (lb.)
	W	H	D	D1	D2	W1	W2	H1	H2	t1	t2	d	
2056	180 (7.09)	300 (11.81)	202 (7.95)	134 (5.28)	68 (2.68)	140 (5.51)	140 (5.51)	284 (11.18)	8 (0.315)	1.6 (0.063)	1.6 (0.063)	M5	6 (13.23)

Table 9.24 400 V class (IP20)

Model	Dimensions mm (in.)												Estimated Weight kg (lb.)
	W	H	D	D1	D2	W1	W2	H1	H2	t1	t2	d	
4031	180 (7.09)	300 (11.81)	202 (7.95)	134 (5.28)	68 (2.68)	140 (5.51)	140 (5.51)	284 (11.18)	8 (0.315)	1.6 (0.063)	1.6 (0.063)	M5	6 (13.23)
4038	180 (7.09)	300 (11.81)	202 (7.95)	134 (5.28)	68 (2.68)	140 (5.51)	140 (5.51)	284 (11.18)	8 (0.315)	1.6 (0.063)	1.6 (0.063)	M5	6 (13.23)

■ 2070, 2082, 4044, 4060

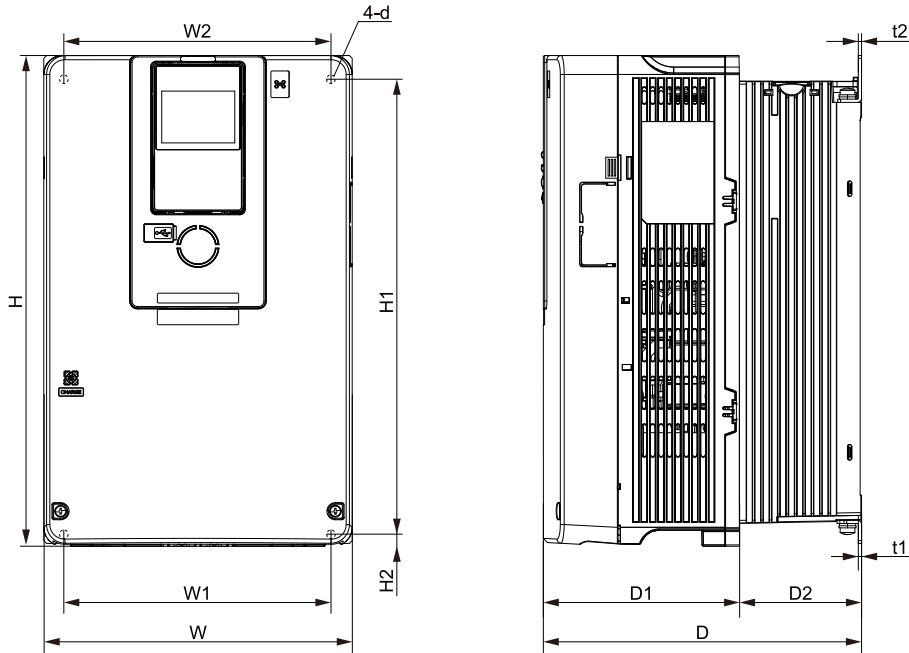


Figure 9.3 Exterior and Mounting Dimensions Diagram 3

Table 9.25 200 V class (IP20)

Model	Dimensions mm (in.)												Estimated Weight kg (lb.)
	W	H	D	D1	D2	W1	W2	H1	H2	t1	t2	d	
2070	220 (8.66)	350 (13.78)	227 (8.94)	140 (5.51)	87 (3.43)	192 (7.56)	192 (7.56)	335 (13.19)	8 (0.315)	2.3 (0.091)	2.3 (0.091)	M6	8.5 (18.74)
2082	220 (8.66)	350 (13.78)	227 (8.94)	140 (5.51)	87 (3.43)	192 (7.56)	192 (7.56)	335 (13.19)	8 (0.315)	2.3 (0.091)	2.3 (0.091)	M6	9.0 (19.84)

Table 9.26 400 V class (IP20)

Model	Dimensions mm (in.)												Estimated Weight kg (lb.)
	W	H	D	D1	D2	W1	W2	H1	H2	t1	t2	d	
4044	220 (8.66)	350 (13.78)	227 (8.94)	140 (5.51)	87 (3.43)	192 (7.56)	192 (7.56)	335 (13.19)	8 (0.315)	2.3 (0.091)	2.3 (0.091)	M6	7.5 (16.53)
4060	220 (8.66)	350 (13.78)	246 (9.69)	140 (5.51)	106 (4.17)	192 (7.56)	192 (7.56)	335 (13.19)	8 (0.315)	2.3 (0.091)	2.3 (0.091)	M6	12 (26.46)

■ 2110, 4075

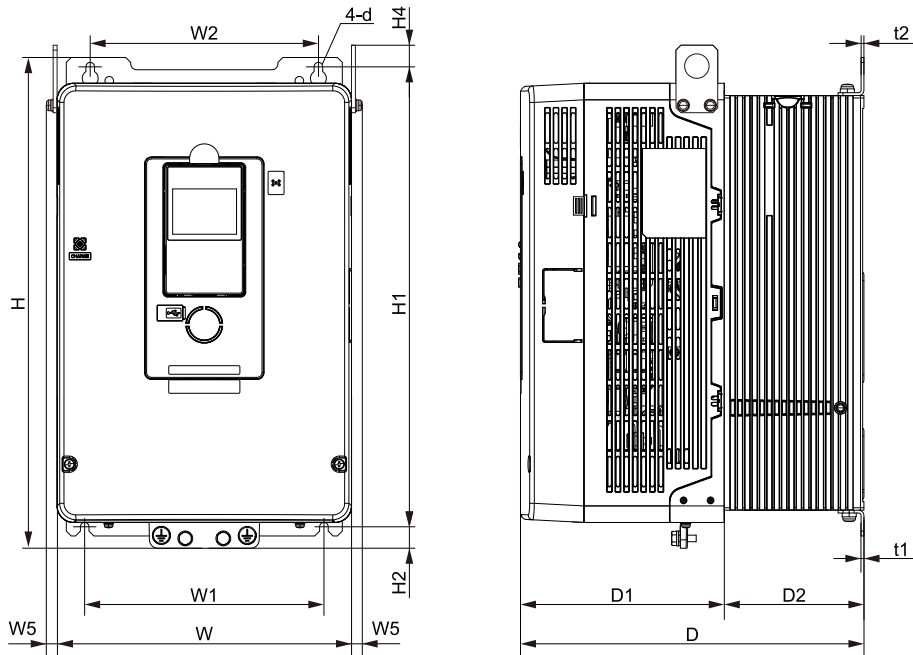


Figure 9.4 Exterior and Mounting Dimensions Diagram 4

Table 9.27 200 V class (IP20)

Model	Dimensions mm (in.)														Estimated Weight kg (lb.)
	W	H	D	D1	D2	W1	W2	W5 (max.)	H1	H2	H4	t1	t2	d	
2110	240 (9.45)	400 (15.75)	280 (11.02)	166 (6.54)	114 (4.49)	195 (7.68)	186 (7.32)	12 (0.472)	375 (14.76)	17.5 (0.689)	17.5 (0.689)	2.3 (0.091)	2.3 (0.091)	M6	22 (48.50)

Table 9.28 400 V class (IP20)

Model	Dimensions mm (in.)														Estimated Weight kg (lb.)
	W	H	D	D1	D2	W1	W2	W5 (max.)	H1	H2	H4	t1	t2	d	
4075	240 (9.45)	400 (15.75)	280 (11.02)	166 (6.54)	114 (4.49)	195 (7.68)	186 (7.32)	12 (0.472)	375 (14.76)	17.5 (0.689)	17.5 (0.689)	2.3 (0.091)	2.3 (0.091)	M6	17 (37.48)

■ 2138, 4089, 4103

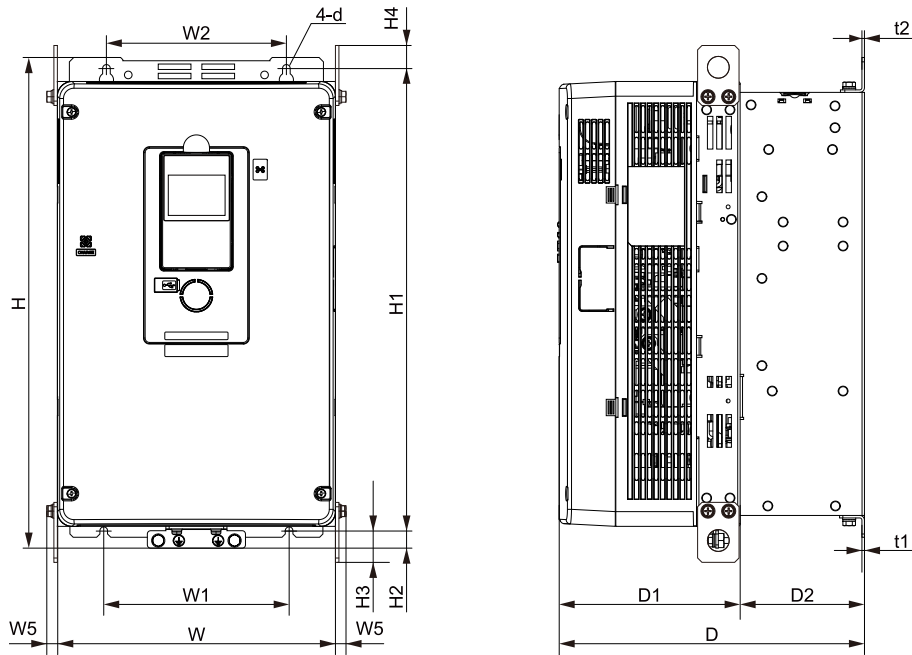


Figure 9.5 Exterior and Mounting Dimensions Diagram 5

Table 9.29 200 V class (IP20)

Model	Dimensions mm (in.)															Estimated Weight kg (lb.)
	W	H	D	D1	D2	W1	W2	W5 (max.)	H1	H2	H3	H4	t1	t2	d	
2138	255 (10.04)	450 (17.72)	280 (11.02)	166 (6.54)	114 (4.49)	170 (6.69)	165 (6.50)	12 (0.472)	424 (16.69)	16 (0.630)	29 (1.14)	21 (0.827)	2.3 (0.091)	2.3 (0.091)	M6	24 (52.91)

Table 9.30 400 V class (IP20)

Model	Dimensions mm (in.)															Estimated Weight kg (lb.)
	W	H	D	D1	D2	W1	W2	W5 (max.)	H1	H2	H3	H4	t1	t2	d	
4089	255 (10.04)	450 (17.72)	280 (11.02)	166 (6.54)	114 (4.49)	170 (6.69)	165 (6.50)	12 (0.472)	424 (16.69)	16 (0.630)	29 (1.14)	21 (0.827)	2.3 (0.091)	2.3 (0.091)	M6	22 (48.50)
4103	255 (10.04)	450 (17.72)	280 (11.02)	166 (6.54)	114 (4.49)	170 (6.69)	165 (6.50)	12 (0.472)	424 (16.69)	16 (0.630)	29 (1.14)	21 (0.827)	2.3 (0.091)	2.3 (0.091)	M6	25 (55.11)

■ 2169, 2211, 4140, 4168

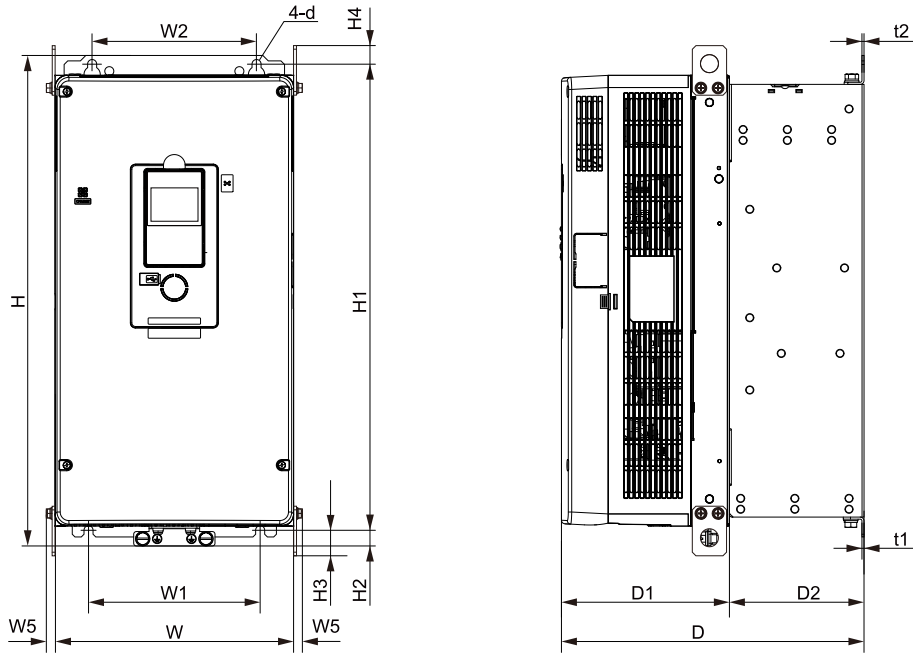


Figure 9.6 Exterior and Mounting Dimensions Diagram 6

Table 9.31 200 V class (IP20)

Model	Dimensions mm (in.)															Estimated Weight kg (lb.)
	W	H	D	D1	D2	W1	W2	W5 (max.)	H1	H2	H3	H4	t1	t2	d	
2169	264 (10.39)	543 (21.38)	335 (13.19)	186 (7.32)	149 (5.87)	190 (7.48)	182 (7.17)	12 (0.472)	516 (20.31)	17.5 (0.689)	28.5 (1.12)	20.5 (0.807)	2.3 (0.091)	2.3 (0.091)	M8	39 (85.98)
2211	264 (10.39)	543 (21.38)	335 (13.19)	186 (7.32)	149 (5.87)	190 (7.48)	182 (7.17)	12 (0.472)	516 (20.31)	17.5 (0.689)	28.5 (1.12)	20.5 (0.807)	2.3 (0.091)	2.3 (0.091)	M8	40 (88.18)

Table 9.32 400 V class (IP20)

Model	Dimensions mm (in.)															Estimated Weight kg (lb.)
	W	H	D	D1	D2	W1	W2	W5 (max.)	H1	H2	H3	H4	t1	t2	d	
4140	264 (10.39)	543 (21.38)	335 (13.19)	186 (7.32)	149 (5.87)	190 (7.48)	182 (7.17)	12 (0.472)	516 (20.31)	17.5 (0.689)	28.5 (1.12)	20.5 (0.807)	2.3 (0.091)	2.3 (0.091)	M8	38 (83.77)
4168	264 (10.39)	543 (21.38)	335 (13.19)	186 (7.32)	149 (5.87)	190 (7.48)	182 (7.17)	12 (0.472)	516 (20.31)	17.5 (0.689)	28.5 (1.12)	20.5 (0.807)	2.3 (0.091)	2.3 (0.091)	M8	39 (85.98)



■ 2257, 2313, 4208 to 4296

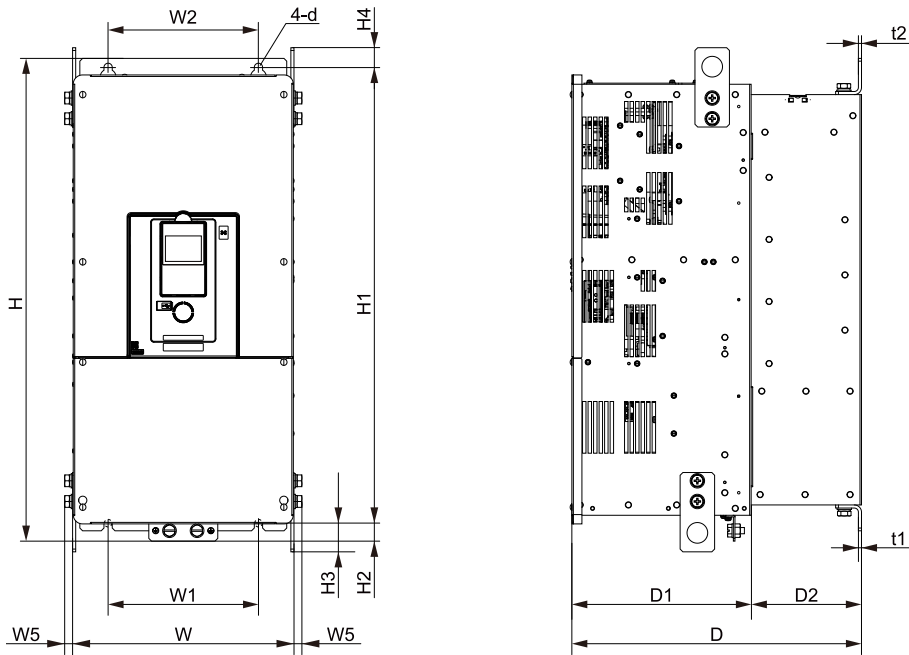


Figure 9.7 Exterior and Mounting Dimensions Diagram 7

Table 9.33 200 V class (IP20)

Model	Dimensions mm (in.)															Estimated Weight kg (lb.)
	W	H	D	D1	D2	W1	W2	W5 (max.)	H1	H2	H3	H4	t1	t2	d	
2257	312 (12.28)	700 (27.56)	420 (16.54)	260 (10.24)	160 (6.30)	218 (8.58)	218 (8.58)	18 (0.709)	659 (25.94)	28 (1.10)	43.5 (1.71)	28.5 (1.12)	4.5 (0.177)	4.5 (0.177)	M10	67 (147.7)
2313	312 (12.28)	700 (27.56)	420 (16.54)	260 (10.24)	160 (6.30)	218 (8.58)	218 (8.58)	18 (0.709)	659 (25.94)	28 (1.10)	43.5 (1.71)	28.5 (1.12)	4.5 (0.177)	4.5 (0.177)	M10	67 (147.7)

Table 9.34 400 V class (IP20)

Model	Dimensions mm (in.)															Estimated Weight kg (lb.)
	W	H	D	D1	D2	W1	W2	W5 (max.)	H1	H2	H3	H4	t1	t2	d	
4208	312 (12.28)	700 (27.56)	420 (16.54)	260 (10.24)	160 (6.30)	218 (8.58)	218 (8.58)	18 (0.709)	659 (25.94)	28 (1.10)	43.5 (1.71)	28.5 (1.12)	4.5 (0.177)	4.5 (0.177)	M10	71 (156.5)
4250	312 (12.28)	700 (27.56)	420 (16.54)	260 (10.24)	160 (6.30)	218 (8.58)	218 (8.58)	18 (0.709)	659 (25.94)	28 (1.10)	43.5 (1.71)	28.5 (1.12)	4.5 (0.177)	4.5 (0.177)	M10	71 (156.5)
4296	312 (12.28)	700 (27.56)	420 (16.54)	260 (10.24)	160 (6.30)	218 (8.58)	218 (8.58)	18 (0.709)	659 (25.94)	28 (1.10)	43.5 (1.71)	28.5 (1.12)	4.5 (0.177)	4.5 (0.177)	M10	71 (156.5)

Specifications

■ 2360, 2415, 4371, 4389

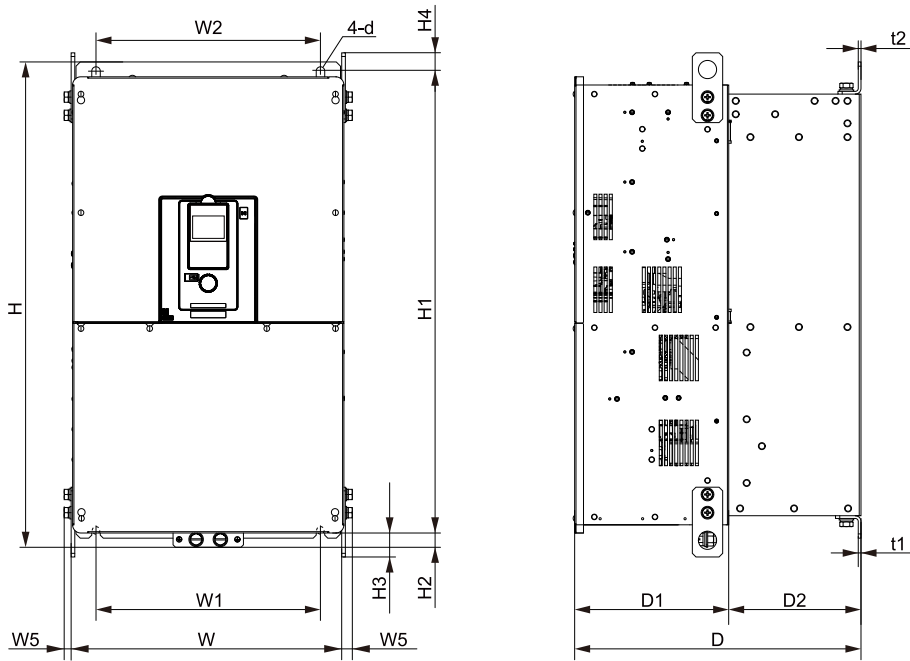


Figure 9.8 Exterior and Mounting Dimensions Diagram 8

Table 9.35 200 V class (IP20)

Model	Dimensions mm (in.)															Estimated Weight kg (lb.)
	W	H	D	D1	D2	W1	W2	W5 (max.)	H1	H2	H3	H4	t1	t2	d	
2360	440 (17.32)	800 (31.50)	472 (18.58)	254 (10.00)	218 (8.58)	370 (14.57)	370 (14.57)	20 (0.787)	757 (29.80)	28 (1.10)	44 (1.73)	30 (1.18)	4.5 (0.177)	4.5 (0.177)	M12	104 (229.3)
2415	440 (17.32)	800 (31.50)	472 (18.58)	254 (10.00)	218 (8.58)	370 (14.57)	370 (14.57)	20 (0.787)	757 (29.80)	28 (1.10)	44 (1.73)	30 (1.18)	4.5 (0.177)	4.5 (0.177)	M12	119 (262.3)

Table 9.36 400 V class (IP20)

Model	Dimensions mm (in.)															Estimated Weight kg (lb.)
	W	H	D	D1	D2	W1	W2	W5 (max.)	H1	H2	H3	H4	t1	t2	d	
4371	440 (17.32)	800 (31.50)	472 (18.58)	254 (10.00)	218 (8.58)	370 (14.57)	370 (14.57)	20 (0.787)	757 (29.80)	28 (1.10)	44 (1.73)	30 (1.18)	4.5 (0.177)	4.5 (0.177)	M12	122 (269.0)
4389	440 (17.32)	800 (31.50)	472 (18.58)	254 (10.00)	218 (8.58)	370 (14.57)	370 (14.57)	20 (0.787)	757 (29.80)	28 (1.10)	44 (1.73)	30 (1.18)	4.5 (0.177)	4.5 (0.177)	M12	126 (277.8)

■ 4453 to 4675

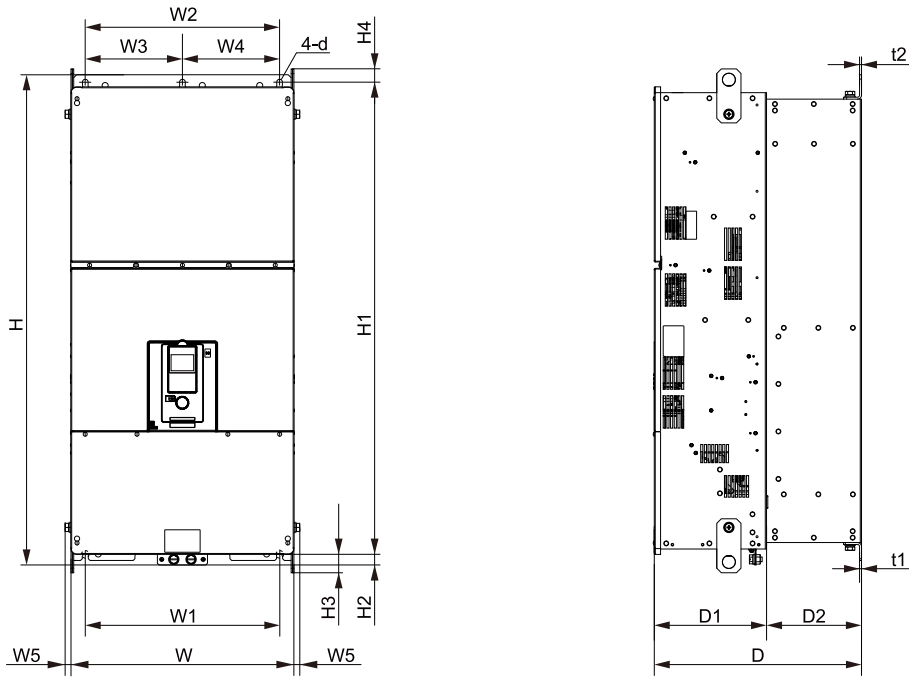


Figure 9.9 Exterior and Mounting Dimensions Diagram 9

Table 9.37 400 V class (IP20)

Model	Dimensions mm (in.)																	Estimated Weight kg (lb.)
	W	H	D	D1	D2	W1	W2	W3	W4	W5 (max.)	H1	H2	H3	H4	t1	t2	d	
4453	510 (20.08)	1140 (44.88)	480 (18.90)	260 (10.24)	220 (8.66)	450 (17.72)	450 (17.72)	225 (8.86)	225 (8.86)	20 (0.787)	1093 (43.03)	25.5 (1.00)	43.5 (1.71)	30.5 (1.20)	4.5 (0.177)	4.5 (0.177)	M12	198 (436.5)
4568	510 (20.08)	1140 (44.88)	480 (18.90)	260 (10.24)	220 (8.66)	450 (17.72)	450 (17.72)	225 (8.86)	225 (8.86)	20 (0.787)	1093 (43.03)	25.5 (1.00)	43.5 (1.71)	30.5 (1.20)	4.5 (0.177)	4.5 (0.177)	M12	198 (436.5)
4675	510 (20.08)	1140 (44.88)	480 (18.90)	260 (10.24)	220 (8.66)	450 (17.72)	450 (17.72)	225 (8.86)	225 (8.86)	20 (0.787)	1093 (43.03)	25.5 (1.00)	43.5 (1.71)	30.5 (1.20)	4.5 (0.177)	4.5 (0.177)	M12	207 (456.3)

◆ Enclosed Wall-mounted Type (UL Type 1)

■ 2004 to 2042, 4002 to 4023

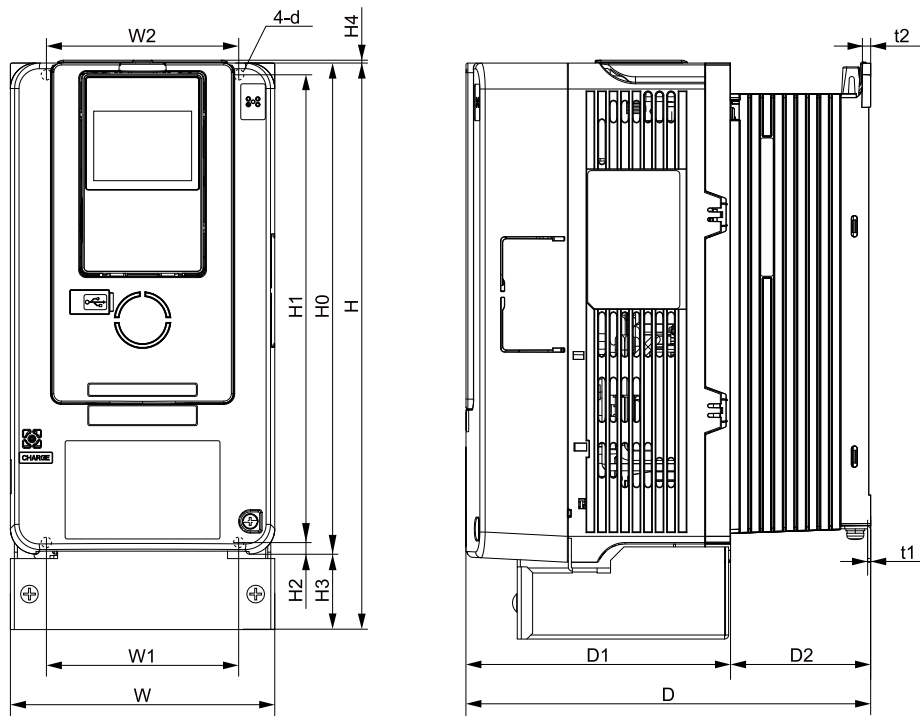


Figure 9.10 Exterior and Mounting Dimensions Diagram 1

Table 9.38 200 V Class (UL Type 1)

Model	Dimensions mm (in.)															Estimated Weight kg (lb.)
	W	H	D	D1	D2	W1	W2	H0	H1	H2	H3	H4	t1	t2	d	
2004	140 (5.51)	300 (11.81)	176 (6.93)	138 (5.43)	38 (1.50)	102 (4.02)	102 (4.02)	260 (10.24)	248 (9.76)	6 (0.236)	40 (1.57)	1.5 (0.059)	1.6 (0.063)	5 (0.197)	M5	4.1 (9.04)
2006	140 (5.51)	300 (11.81)	176 (6.93)	138 (5.43)	38 (1.50)	102 (4.02)	102 (4.02)	260 (10.24)	248 (9.76)	6 (0.236)	40 (1.57)	1.5 (0.059)	1.6 (0.063)	5 (0.197)	M5	4.1 (9.04)
2010	140 (5.51)	300 (11.81)	176 (6.93)	138 (5.43)	38 (1.50)	102 (4.02)	102 (4.02)	260 (10.24)	248 (9.76)	6 (0.236)	40 (1.57)	1.5 (0.059)	1.6 (0.063)	5 (0.197)	M5	4.1 (9.04)
2012	140 (5.51)	300 (11.81)	176 (6.93)	138 (5.43)	38 (1.50)	102 (4.02)	102 (4.02)	260 (10.24)	248 (9.76)	6 (0.236)	40 (1.57)	1.5 (0.059)	1.6 (0.063)	5 (0.197)	M5	4.1 (9.04)
2018	140 (5.51)	300 (11.81)	211 (8.31)	138 (5.43)	73 (2.87)	102 (4.02)	102 (4.02)	260 (10.24)	248 (9.76)	6 (0.236)	40 (1.57)	1.5 (0.059)	1.6 (0.063)	5 (0.197)	M5	4.5 (9.92)
2021	140 (5.51)	300 (11.81)	211 (8.31)	138 (5.43)	73 (2.87)	102 (4.02)	102 (4.02)	260 (10.24)	248 (9.76)	6 (0.236)	40 (1.57)	1.5 (0.059)	1.6 (0.063)	5 (0.197)	M5	4.5 (9.92)
2030	140 (5.51)	300 (11.81)	211 (8.31)	138 (5.43)	73 (2.87)	102 (4.02)	102 (4.02)	260 (10.24)	248 (9.76)	6 (0.236)	40 (1.57)	1.5 (0.059)	1.6 (0.063)	5 (0.197)	M5	4.8 (10.58)
2042	140 (5.51)	300 (11.81)	211 (8.31)	138 (5.43)	73 (2.87)	102 (4.02)	102 (4.02)	260 (10.24)	248 (9.76)	6 (0.236)	40 (1.57)	1.5 (0.059)	1.6 (0.063)	5 (0.197)	M5	4.8 (10.58)

Table 9.39 400 V Class (UL Type 1)

Model	Dimensions mm (in.)															Estimated Weight kg (lb.)
	W	H	D	D1	D2	W1	W2	H0	H1	H2	H3	H4	t1	t2	d	
4002	140 (5.51)	300 (11.81)	176 (6.93)	138 (5.43)	38 (1.50)	102 (4.02)	102 (4.02)	260 (10.24)	248 (9.76)	6 (0.236)	40 (1.57)	1.5 (0.059)	1.6 (0.063)	5 (0.197)	M5	4.1 (9.04)
4004	140 (5.51)	300 (11.81)	176 (6.93)	138 (5.43)	38 (1.50)	102 (4.02)	102 (4.02)	260 (10.24)	248 (9.76)	6 (0.236)	40 (1.57)	1.5 (0.059)	1.6 (0.063)	5 (0.197)	M5	4.1 (9.04)
4005	140 (5.51)	300 (11.81)	176 (6.93)	138 (5.43)	38 (1.50)	102 (4.02)	102 (4.02)	260 (10.24)	248 (9.76)	6 (0.236)	40 (1.57)	1.5 (0.059)	1.6 (0.063)	5 (0.197)	M5	4.1 (9.04)
4007	140 (5.51)	300 (11.81)	211 (8.31)	138 (5.43)	73 (2.87)	102 (4.02)	102 (4.02)	260 (10.24)	248 (9.76)	6 (0.236)	40 (1.57)	1.5 (0.059)	1.6 (0.063)	5 (0.197)	M5	4.5 (9.92)
4009	140 (5.51)	300 (11.81)	211 (8.31)	138 (5.43)	73 (2.87)	102 (4.02)	102 (4.02)	260 (10.24)	248 (9.76)	6 (0.236)	40 (1.57)	1.5 (0.059)	1.6 (0.063)	5 (0.197)	M5	4.5 (9.92)
4012	140 (5.51)	300 (11.81)	211 (8.31)	138 (5.43)	73 (2.87)	102 (4.02)	102 (4.02)	260 (10.24)	248 (9.76)	6 (0.236)	40 (1.57)	1.5 (0.059)	1.6 (0.063)	5 (0.197)	M5	4.5 (9.92)
4018	140 (5.51)	300 (11.81)	211 (8.31)	138 (5.43)	73 (2.87)	102 (4.02)	102 (4.02)	260 (10.24)	248 (9.76)	6 (0.236)	40 (1.57)	1.5 (0.059)	1.6 (0.063)	5 (0.197)	M5	4.8 (10.58)
4023	140 (5.51)	300 (11.81)	211 (8.31)	138 (5.43)	73 (2.87)	102 (4.02)	102 (4.02)	260 (10.24)	248 (9.76)	6 (0.236)	40 (1.57)	1.5 (0.059)	1.6 (0.063)	5 (0.197)	M5	4.8 (10.58)

■ 2056, 4031, 4038

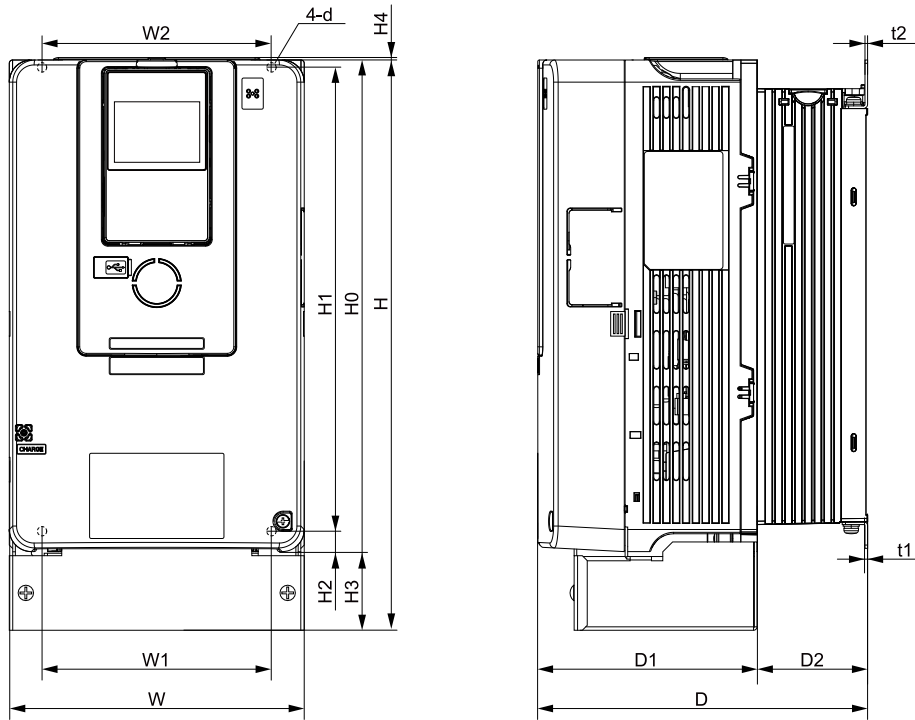


Figure 9.11 Exterior and Mounting Dimensions Diagram 2

Table 9.40 200 V Class (UL Type 1)

Model	Dimensions mm (in.)															Estimated Weight kg (lb.)
	W	H	D	D1	D2	W1	W2	H0	H1	H2	H3	H4	t1	t2	d	
2056	180 (7.09)	340 (13.39)	202 (7.95)	134 (5.28)	68 (2.68)	140 (5.51)	140 (5.51)	300 (11.81)	284 (11.18)	8 (0.315)	40 (1.57)	1.5 (0.059)	1.6 (0.063)	1.6 (0.063)	M5	7 (15.43)

Table 9.41 400 V Class (UL Type 1)

Model	Dimensions mm (in.)															Estimated Weight kg (lb.)
	W	H	D	D1	D2	W1	W2	H0	H1	H2	H3	H4	t1	t2	d	
4031	180 (7.09)	340 (13.39)	202 (7.95)	134 (5.28)	68 (2.68)	140 (5.51)	140 (5.51)	300 (11.81)	284 (11.18)	8 (0.315)	40 (1.57)	1.5 (0.059)	1.6 (0.063)	1.6 (0.063)	M5	7 (15.43)
4038	180 (7.09)	340 (13.39)	202 (7.95)	134 (5.28)	68 (2.68)	140 (5.51)	140 (5.51)	300 (11.81)	284 (11.18)	8 (0.315)	40 (1.57)	1.5 (0.059)	1.6 (0.063)	1.6 (0.063)	M5	7 (15.43)

■ 2070, 2082, 4044, 4060

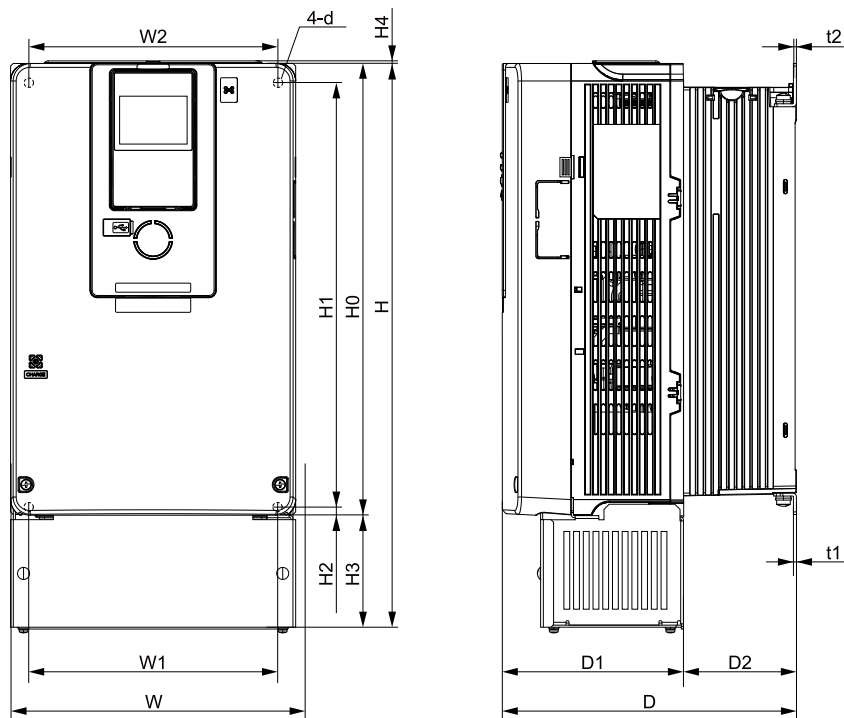


Figure 9.12 Exterior and Mounting Dimensions Diagram 3

Table 9.42 200 V Class (UL Type 1)

Model	Dimensions mm (in.)															Estimated Weight kg (lb.)
	W	H	D	D1	D2	W1	W2	H0	H1	H2	H3	H4	t1	t2	d	
2070	220 (8.66)	400 (15.75)	227 (8.94)	140 (5.51)	87 (3.43)	192 (7.56)	192 (7.56)	350 (13.78)	335 (13.19)	8 (0.315)	50 (1.97)	1.5 (0.059)	2.3 (0.091)	2.3 (0.091)	M6	9 (19.84)
2082	220 (8.66)	435 (17.13)	227 (8.94)	140 (5.51)	87 (3.43)	192 (7.56)	192 (7.56)	350 (13.78)	335 (13.19)	8 (0.315)	85 (3.35)	1.5 (0.059)	2.3 (0.091)	2.3 (0.091)	M6	10 (22.05)

Table 9.43 400 V Class (UL Type 1)

Model	Dimensions mm (in.)															Estimated Weight kg (lb.)
	W	H	D	D1	D2	W1	W2	H0	H1	H2	H3	H4	t1	t2	d	
4044	220 (8.66)	400 (15.75)	227 (8.94)	140 (5.51)	87 (3.43)	192 (7.56)	192 (7.56)	350 (13.78)	335 (13.19)	8 (0.315)	50 (1.97)	1.5 (0.059)	2.3 (0.091)	2.3 (0.091)	M6	8.5 (18.74)
4060	220 (8.66)	400 (15.75)	246 (9.69)	140 (5.51)	106 (4.17)	192 (7.56)	192 (7.56)	350 (13.78)	335 (13.19)	8 (0.315)	50 (1.97)	1.5 (0.059)	2.3 (0.091)	2.3 (0.091)	M6	13 (28.66)

■ 2110, 4075

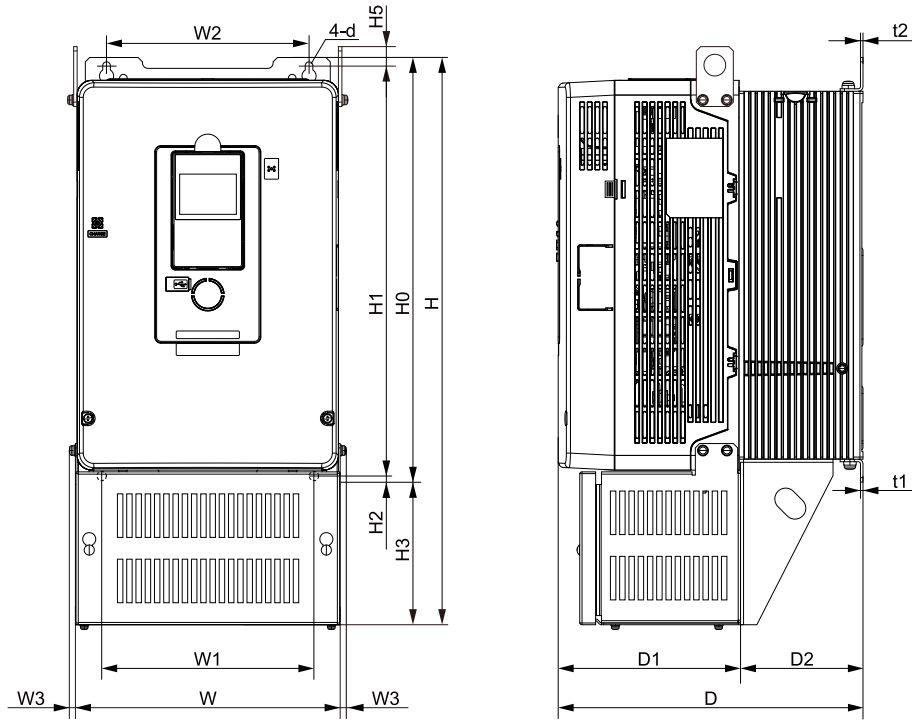


Figure 9.13 Exterior and Mounting Dimensions Diagram 4

Table 9.44 200 V Class (UL Type 1)

Model	Dimensions mm (in.)																Estimated Weight kg (lb.)
	W	H	D	D1	D2	W1	W2	W3 (max.)	H0	H1	H2	H3	H5	t1	t2	d	
2110	244 (9.61)	500 (19.69)	280 (11.02)	166 (6.54)	114 (4.49)	195 (7.68)	186 (7.32)	10 (0.394)	400 (15.75)	375 (14.76)	17.5 (0.689)	100 (3.94)	17.5 (0.689)	2.3 (0.091)	2.3 (0.091)	M6	24 (52.91)

Table 9.45 400 V Class (UL Type 1)

Model	Dimensions mm (in.)																Estimated Weight kg (lb.)
	W	H	D	D1	D2	W1	W2	W3 (max.)	H0	H1	H2	H3	H5	t1	t2	d	
4075	244 (9.61)	500 (19.69)	280 (11.02)	166 (6.54)	114 (4.49)	195 (7.68)	186 (7.32)	10 (0.394)	400 (15.75)	375 (14.76)	17.5 (0.689)	100 (3.94)	17.5 (0.689)	2.3 (0.091)	2.3 (0.091)	M6	20 (44.09)



■ 2138, 4089, 4103

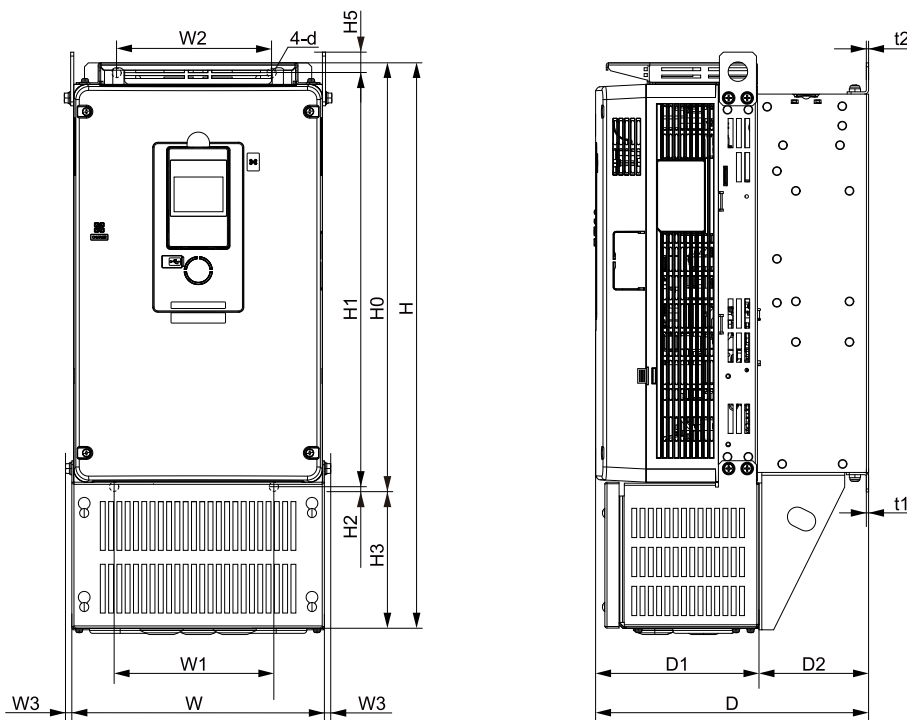


Figure 9.14 Exterior and Mounting Dimensions Diagram 5

Table 9.46 200 V Class (UL Type 1)

Model	Dimensions mm (in.)																Estimated Weight kg (lb.)
	W	H	D	D1	D2	W1	W2	W3 (max.)	H0	H1	H2	H3	H5	t1	t2	d	
2138	259 (10.20)	580 (22.83)	280 (11.02)	166 (6.54)	114 (4.49)	170 (6.69)	165 (6.50)	10 (0.394)	450 (17.72)	424 (16.69)	16 (0.630)	130 (5.12)	21 (0.827)	2.3 (0.091)	2.3 (0.091)	M6	27 (59.52)

Table 9.47 400 V Class (UL Type 1)

Model	Dimensions mm (in.)																Estimated Weight kg (lb.)
	W	H	D	D1	D2	W1	W2	W3 (max.)	H0	H1	H2	H3	H5	t1	t2	d	
4089	259 (10.20)	580 (22.83)	280 (11.02)	166 (6.54)	114 (4.49)	170 (6.69)	165 (6.50)	10 (0.394)	450 (17.72)	424 (16.69)	16 (0.630)	130 (5.12)	21 (0.827)	2.3 (0.091)	2.3 (0.091)	M6	25 (55.11)
4103	259 (10.20)	580 (22.83)	280 (11.02)	166 (6.54)	114 (4.49)	170 (6.69)	165 (6.50)	10 (0.394)	450 (17.72)	424 (16.69)	16 (0.630)	130 (5.12)	21 (0.827)	2.3 (0.091)	2.3 (0.091)	M6	29 (63.93)

■ 2169, 2211, 4140, 4168

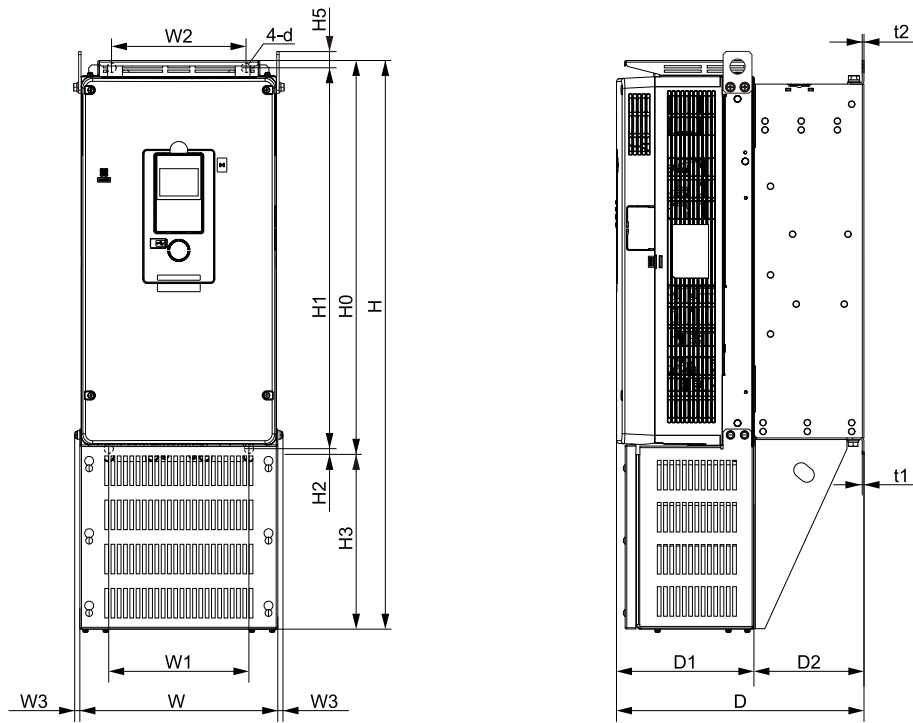


Figure 9.15 Exterior and Mounting Dimensions Diagram 6

Table 9.48 200 V Class (UL Type 1)

Model	Dimensions mm (in.)																Estimated Weight kg (lb.)
	W	H	D	D1	D2	W1	W2	W3 (max.)	H0	H1	H2	H3	H5	t1	t2	d	
2169	268 (10.55)	700 (27.56)	335 (13.19)	186 (7.32)	149 (5.87)	190 (7.48)	182 (7.17)	10 (0.394)	543 (21.38)	516 (20.31)	17.5 (0.689)	157 (6.18)	20.5 (0.807)	2.3 (0.091)	2.3 (0.091)	M8	44 (97.00)
2211	268 (10.55)	770 (30.31)	335 (13.19)	186 (7.32)	149 (5.87)	190 (7.48)	182 (7.17)	10 (0.394)	543 (21.38)	516 (20.31)	17.5 (0.689)	227 (8.94)	20.5 (0.807)	2.3 (0.091)	2.3 (0.091)	M8	46 (101.41)

Table 9.49 400 V Class (UL Type 1)

Model	Dimensions mm (in.)																Estimated Weight kg (lb.)
	W	H	D	D1	D2	W1	W2	W3 (max.)	H0	H1	H2	H3	H5	t1	t2	d	
4140	268 (10.55)	700 (27.56)	335 (13.19)	186 (7.32)	149 (5.87)	190 (7.48)	182 (7.17)	10 (0.394)	543 (21.38)	516 (20.31)	17.5 (0.689)	157 (6.18)	20.5 (0.807)	2.3 (0.091)	2.3 (0.091)	M8	43 (94.80)
4168	268 (10.55)	700 (27.56)	335 (13.19)	186 (7.32)	149 (5.87)	190 (7.48)	182 (7.17)	10 (0.394)	543 (21.38)	516 (20.31)	17.5 (0.689)	157 (6.18)	20.5 (0.807)	2.3 (0.091)	2.3 (0.091)	M8	44 (97.00)

■ 2257, 2313, 4208 to 4296

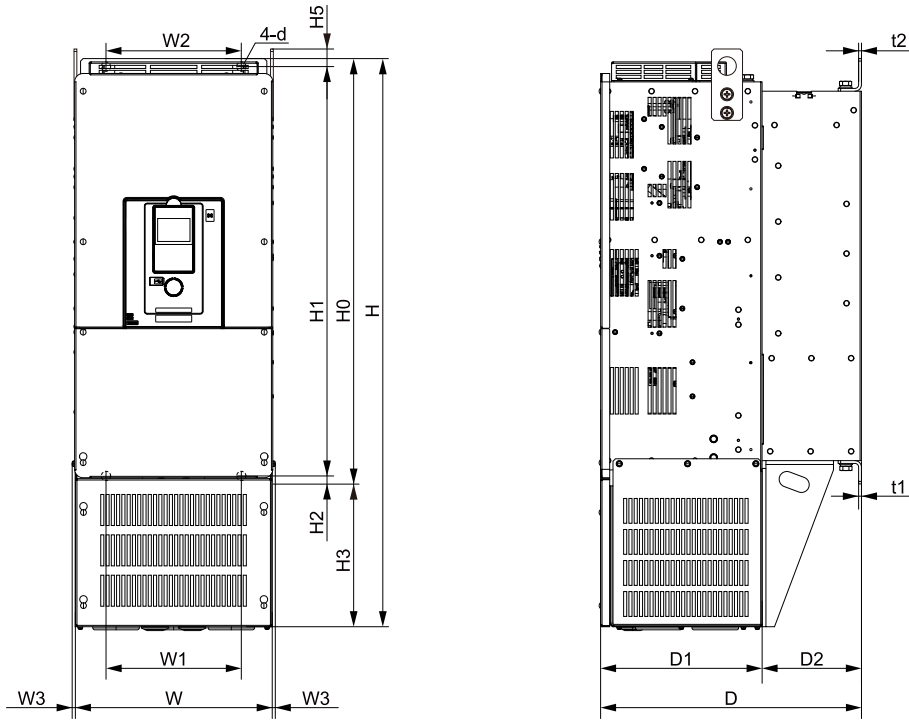


Figure 9.16 Exterior and Mounting Dimensions Diagram 7

Table 9.50 200 V Class (UL Type 1)

Model	Dimensions mm (in.)																Estimated Weight kg (lb.)
	W	H	D	D1	D2	W1	W2	W3 (max.)	H0	H1	H2	H3	H5	t1	t2	d	
2257	316 (12.44)	915 (36.02)	420 (16.54)	260 (10.24)	160 (6.30)	218 (8.58)	218 (8.58)	16 (0.630)	700 (27.56)	659 (25.94)	28 (1.102)	215 (8.46)	28.5 (1.122)	4.5 (0.177)	4.5 (0.177)	M10	72 (158.73)
2313	316 (12.44)	915 (36.02)	420 (16.54)	260 (10.24)	160 (6.30)	218 (8.58)	218 (8.58)	16 (0.630)	700 (27.56)	659 (25.94)	28 (1.102)	215 (8.46)	28.5 (1.122)	4.5 (0.177)	4.5 (0.177)	M10	72 (158.73)

Table 9.51 400 V Class (UL Type 1)

Model	Dimensions mm (in.)																Estimated Weight kg (lb.)
	W	H	D	D1	D2	W1	W2	W3 (max.)	H0	H1	H2	H3	H5	t1	t2	d	
4208	316 (12.44)	915 (36.02)	420 (16.54)	260 (10.24)	160 (6.30)	218 (8.58)	218 (8.58)	16 (0.630)	700 (27.56)	659 (25.94)	28 (1.102)	215 (8.46)	28.5 (1.122)	4.5 (0.177)	4.5 (0.177)	M10	79 (174.16)
4250	316 (12.44)	915 (36.02)	420 (16.54)	260 (10.24)	160 (6.30)	218 (8.58)	218 (8.58)	16 (0.630)	700 (27.56)	659 (25.94)	28 (1.102)	215 (8.46)	28.5 (1.122)	4.5 (0.177)	4.5 (0.177)	M10	79 (174.16)
4296	316 (12.44)	915 (36.02)	420 (16.54)	260 (10.24)	160 (6.30)	218 (8.58)	218 (8.58)	16 (0.630)	700 (27.56)	659 (25.94)	28 (1.102)	215 (8.46)	28.5 (1.122)	4.5 (0.177)	4.5 (0.177)	M10	79 (174.16)

■ 2360, 4371

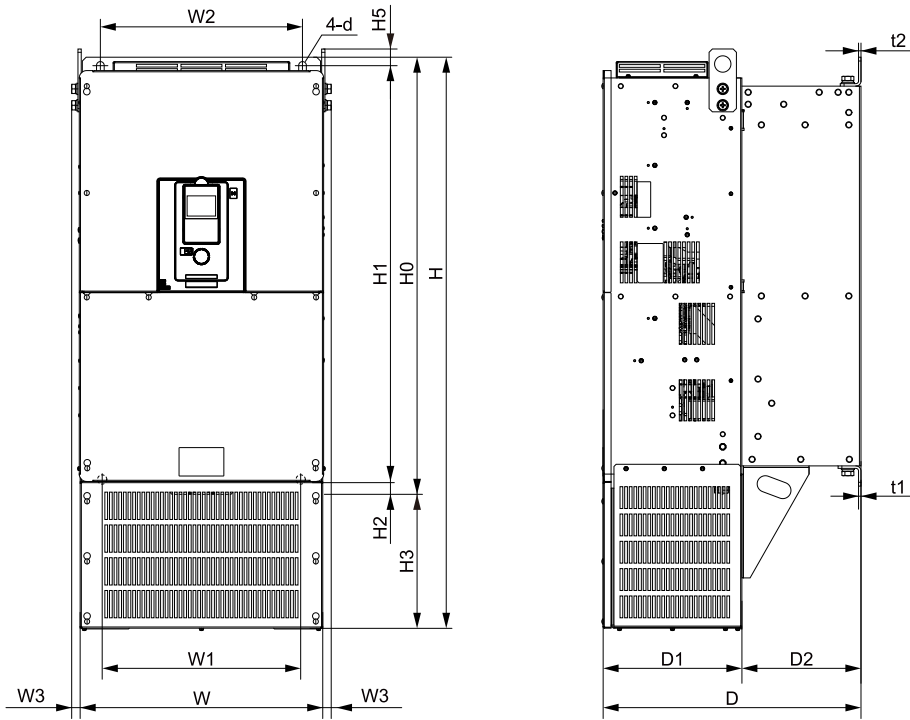


Figure 9.17 Exterior and Mounting Dimensions Diagram 8

Table 9.52 200 V Class (UL Type 1)

Model	Dimensions mm (in.)																Estimated Weight kg (lb.)
	W	H	D	D1	D2	W1	W2	W3 (max.)	H0	H1	H2	H3	H5	t1	t2	d	
2360	444 (17.48)	1045 (41.14)	472 (18.58)	254 (10.00)	218 (8.58)	370 (14.57)	370 (14.57)	18 (0.709)	800 (31.50)	757 (29.80)	28 (1.102)	245 (9.65)	30 (1.181)	4.5 (0.177)	4.5 (0.177)	M12	113 (249.12)

Table 9.53 400 V Class (UL Type 1)

Model	Dimensions mm (in.)																Estimated Weight kg (lb.)
	W	H	D	D1	D2	W1	W2	W3 (max.)	H0	H1	H2	H3	H5	t1	t2	d	
4371	444 (17.48)	1045 (41.14)	472 (18.58)	254 (10.00)	218 (8.58)	370 (14.57)	370 (14.57)	18 (0.709)	800 (31.50)	757 (29.80)	28 (1.102)	245 (9.65)	30 (1.181)	4.5 (0.177)	4.5 (0.177)	M12	130 (286.60)

## 9.8 Knock-Out Hole Dimensions (UL Type 1)

### ◆ Models and Dimensions of Knock-Out Hole

Model	Reference
2004 to 2042 4002 to 4023	485
2056 4031, 4038	486
2070, 2082 4044, 4060	486
2110 4075	487
2138 4089, 4103	487
2169 4140, 4168	488
2211	488
2257, 2313 4208 - 4296	489
2360 4371	489

#### ■ 2004 to 2042, 4002 to 4023

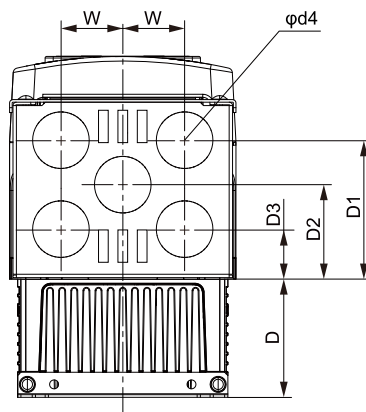


Figure 9.18 Knock-Out Dimensions Diagram 1 (Models: 2004 to 2042 and 4002 to 4023)

Model	Dimensions mm (in.)					
	D	D1	D2	D3	W	φd4
2004 to 2012 4002 to 4005	39 (1.54)	85 (3.35)	57.5 (2.26)	30 (1.18)	38.2 (1.50)	35 (1.38)
2018 to 2042 4007 to 4023	74 (2.91)	85 (3.35)	57.5 (2.26)	30 (1.18)	38.2 (1.50)	35 (1.38)

■ 2056, 4031, 4038

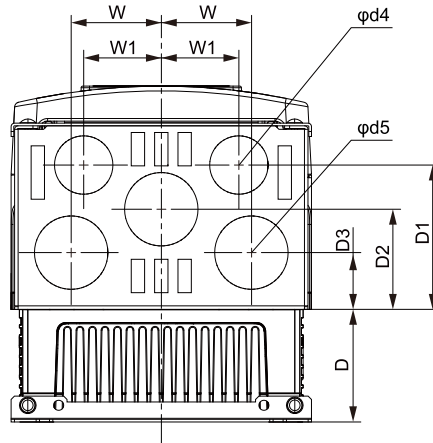


Figure 9.19 Knock-Out Dimensions Diagram 2 (Models: 2056, 4031, and 4038)

Model	Dimensions mm (in.)							
	D	D1	D2	D3	W	W1	φd4	φd5
2056	67.5	86.5	60	34	54	46.5	35	44
4031, 4038	(2.66)	(3.41)	(2.36)	(1.34)	(2.13)	(1.83)	(1.38)	(1.73)

■ 2070, 2082, 4044, 4060

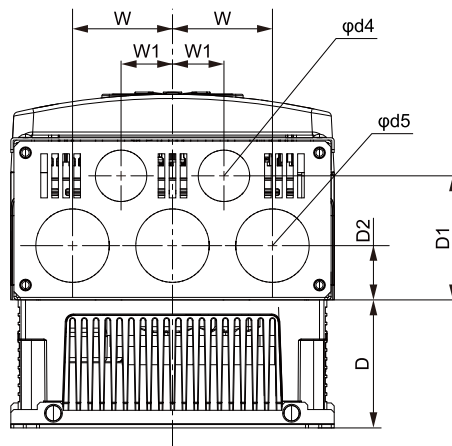


Figure 9.20 Knock-Out Dimensions Diagram 3 (Models: 2070, 2082, 4044, and 4060)

Model	Dimensions mm (in.)							
	D	D1	D2	W	W1	φd4	φd5	
2070, 2082	87.2	84.3	36.8	68	35	35	50	
4044	(3.43)	(3.32)	(1.45)	(2.68)	(1.38)	(1.38)	(1.97)	
4060	106.2	84.3	36.8	68	35	35	50	
	(4.18)	(3.32)	(1.45)	(2.68)	(1.38)	(1.38)	(1.97)	

■ 2110, 4075

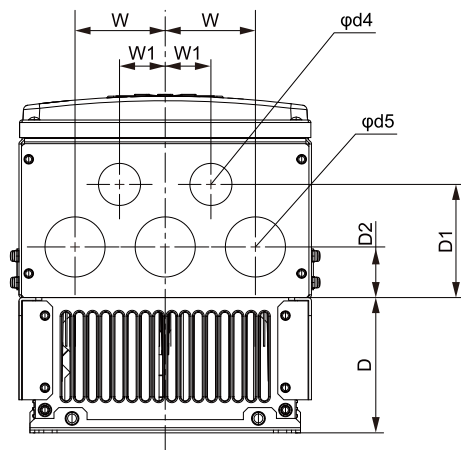


Figure 9.21 Knock-Out Dimensions Diagram 4 (Models: 2110 and 4075)

Model	Dimensions mm (in.)						
	D	D1	D2	W	W1	φd4	φd5
2110	112.5	96	48.5	73	38	35	50
4075	(4.43)	(3.78)	(1.91)	(2.87)	(1.50)	(1.38)	(1.97)

■ 2138, 4089, 4103

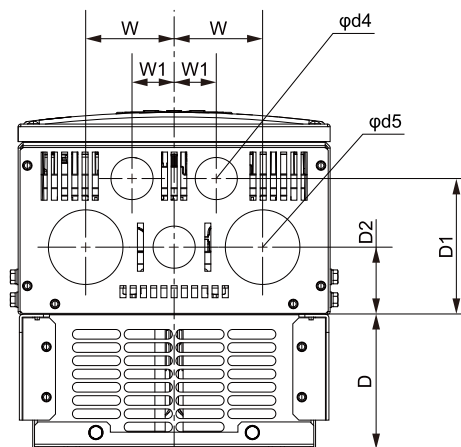


Figure 9.22 Knock-Out Dimensions Diagram 5 (Models: 2138, 4089, and 4103)

Model	Dimensions mm (in.)						
	D	D1	D2	W	W1	φd4	φd5
2138	112.4	112.8	55.8	73.5	35	35	62
4089, 4103	(4.43)	(4.44)	(2.20)	(2.89)	(1.38)	(1.38)	(2.44)

■ 2169, 4140, 4168

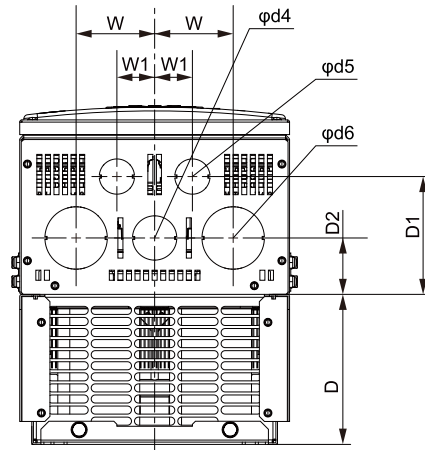


Figure 9.23 Knock-Out Dimensions Diagram 6 (Models: 2169, 4140, and 4168)

Model	Dimensions mm (in.)							
	D	D1	D2	W	W1	φd4	φd5	φd6
2169	149	117	56	78	37.5	44	35	62
4140, 4168	(5.87)	(4.61)	(2.20)	(3.07)	(1.48)	(1.73)	(1.38)	(2.44)

■ 2211

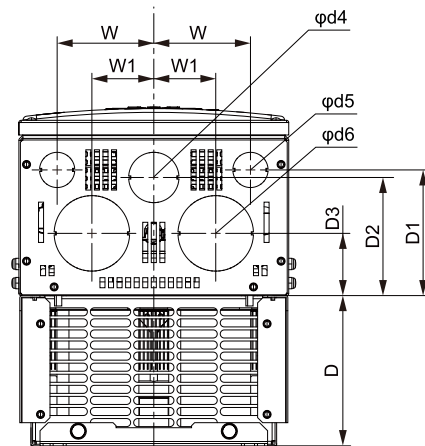


Figure 9.24 Knock-Out Dimensions Diagram 7 (Models: 2211)

Model	Dimensions mm (in.)								
	D	D1	D2	D3	W	W1	φd4	φd5	φd6
2211	149	124.8	117.3	61.8	96	61.5	50	35	75
	(5.87)	(4.91)	(4.62)	(2.43)	(3.78)	(2.42)	(1.97)	(1.38)	(2.95)



■ 2257, 2313, 4208 to 4296

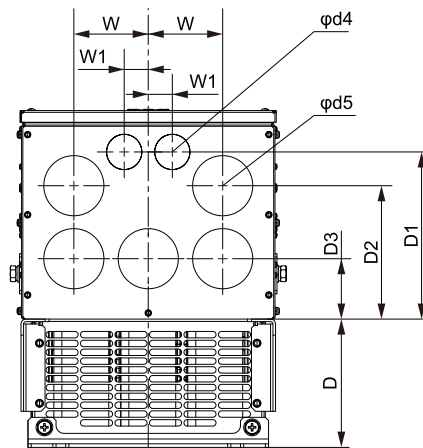


Figure 9.25 Knock-Out Dimensions Diagram 8 (Models: 2257, 2313, 4208, 4250, and 4296)

Model	Dimensions mm (in.)							
	D	D1	D2	D3	W	W1	φd4	φd5
2257, 2313 4208, 4250, 4296	160 (6.30)	208.4 (8.20)	166.3 (6.55)	75.3 (2.96)	92.8 (3.65)	27.5 (1.08)	35 (1.38)	62 (2.44)

■ 2360, 4371

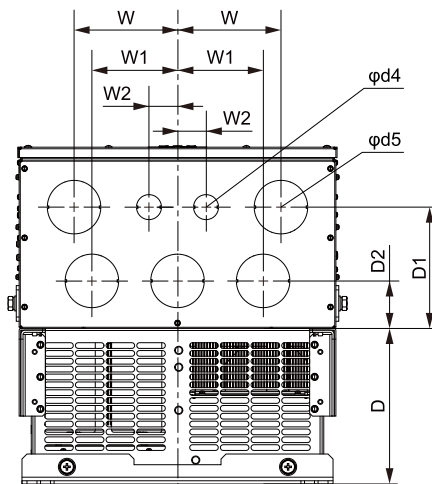


Figure 9.26 Knock-Out Dimensions Diagram 9 (Models: 2360 and 4371)

Model	Dimensions mm (in.)							
	D	D1	D2	W	W1	W2	φd4	φd5
2360 4371	218 (8.58)	170 (6.69)	66.6 (2.62)	145 (5.71)	40 (1.57)	120 (4.72)	35 (1.38)	75 (2.95)

## 9.9 Peripheral Devices and Options

Table 9.54 to Table 9.59 show the available peripheral devices and options for the drive. Contact Yaskawa or your nearest sales representative to make an order.

- Selection: Refer to the drive catalog for information about available products.
- Installation and wiring: Refer to the instruction manual for each option.

**Table 9.54 Main Circuit Options**

Name	Model	Purpose
DC Reactor	UZDA series	To improve the drive input power factor. <ul style="list-style-type: none"> <li>• To prevent damage to the drive when the power supply capacity is large. You must only use this option when the power supply capacity is more than 600 kVA.</li> <li>• To decrease harmonic current.</li> <li>• To improve the power supply total power factor.</li> </ul>
AC Reactor	UZBA series	To improve the drive input power factor. <ul style="list-style-type: none"> <li>• To prevent damage to the drive when the power supply capacity is large. You must only use this option when the power supply capacity is more than 600 kVA.</li> <li>• To decrease harmonic current.</li> <li>• To improve the power supply total power factor.</li> </ul>
Braking Resistor	ERF-150WJ Series	To decrease the regenerative energy of the motor and decrease the deceleration time (duty cycle of 3% ED). You must also use the installation attachment.
Braking Resistor with Fuse	CF120-B579 Series	To decrease the regenerative energy of the motor and decrease the deceleration time (duty cycle of 3% ED). You must also use the installation attachment.
Braking Resistor Unit	LKEB series	To decrease the regenerative energy of the motor and decrease the deceleration time (duty cycle of 10% ED). The unit contains a thermal overload relay.
Braking Unit	CDBR series	Use with a braking resistor unit to decrease motor deceleration times.
Molded-Case Circuit Breaker (MCCB)	NF series	To prevent short circuit damage to the power supply system and provide overload protection for wiring.
Residual Current Monitor/Detector (RCM/RCD)	NV and NS series	To prevent short circuit damage to the power supply system, provide overload protection for wiring, prevent electrical shock, and provide ground fault protection against earth leakage fires. <p><b>Note:</b></p> <ul style="list-style-type: none"> <li>• You can use a molded-case circuit breaker as a replacement for an RCM/RCD that is upstream in the power supply system.</li> <li>• When you use a high frequency RCM/RCD at the power input side of the drive, make sure that each drive has a minimum cumulative sensitivity amperage of 30 mA.</li> </ul>
Input Side Magnetic Contactor (MC)	SC series	To prevent burn damage when connecting a braking resistor. This option fully opens the circuit between the power supply and drive.
Surge Protective Device	200 V class: DCR2-xA 400 V class: RFN3AL-504KD	To absorb open/close surges from the magnetic contactor and control relay. You must connect this option to magnetic contactors, control relays, magnetic valves, or magnetic brake coils.
Zero-Phase Reactor	F6045GB F11080GB F200160PB	To decrease wiring noise. You can use this option on the input side and the output side of the drive. <p><b>Note:</b></p> Install this option around the drive input power system and as near to the drive as possible.
Fuse Fuse Holder	200 V class: CR2LS series, CR2L series, or FWX series 400 V class: CR6L series, CS5F series, or FWH series	To prevent part failure, Yaskawa recommends that you connect a fuse to the input side of the drive.
Input Side Noise Filter	LNFB, LNFD, and FN series	To decrease wiring noise. <p><b>Note:</b></p> Install this option around the drive input power system and as near to the drive as possible.

Name	Model	Purpose
Output Side Noise Filter	LF series	To decrease wiring noise. <b>Note:</b> Install this option around the drive input power system and as near to the drive as possible.
Capacitor-Type Noise Filter	3XYG 1003	To decrease wiring noise. You must only use this option around the drive input power system. Do not connect this option to the output side.
Momentary Power Loss Recovery Unit	200V class: P0010 400 V class: P0020	To make sure that the drive has power during the momentary power loss ride-thru time (2 seconds).
Low-Voltage Manual Load Switch	“AICUT” LB series	PM motors act as generators when coasting to provide voltage to terminals. Install this option to prevent electric shock.

Table 9.55 Frequency Settings and Monitor Options

Name	Model	Purpose
Frequency Meter and Ammeter	DCF-6A	To use analog signals from the drive to monitor the output frequency and current.
Output Voltmeter	SDF-12NH	To use analog signals from the drive to monitor the output voltage.
Frequency Setting Potentiometer (2 kΩ)	RV30YN20S: 2 kΩ	To use an analog input to set the frequency.
Frequency Meter Scale Correction Resistor (20 kΩ)	RV30YN20S: 20 kΩ	To adjust the frequency scaling.
Control Dial For Frequency Setting Potentiometer	CM-3S	Use this option with the frequency setting potentiometer.
Potential Transformer	UPN-B	To adjust the meter voltage.
Scale Plate	NPJT41561-1	Use this option with the frequency setting potentiometer.

Table 9.56 Keypad Options

Name	Model	Purpose
LED Keypad	JVOP-KPLEA04xxx	A replacement keypad that has an LED display. Use connection cables that are 3 m (9.8 ft) long maximum to connect this keypad for remote operation.
LCD Operator Extension Cable	WV001 (1 m [3.3 ft] length) WV003 (3 m [9.8 ft] length)	To connect the keypad and drive. This option is an RJ-45, 8-pin straight-through UTP CAT5e cable.
Installation Support Set A	900-192-933-001	To attach the keypad to the control panel. This option uses screws.
Installation Support Set B	900-192-933-002	To attach the keypad to the control panel. This option uses nut clamps. Use this option when weld studs are located in the control panel.

Table 9.57 Attachments

Name	Model	Purpose
External Heatsink Mount Kit	900-193-209-001 900-193-209-002 900-193-209-003	Use this option to install the heatsink outside of the control panel. <b>Note:</b> When you use external heatsink mounting, it may be necessary to decrease the current.
UL Type 1 Kit	900-192-121-001 900-192-121-002 900-192-121-003 900-192-121-004 900-192-121-005	To change an open chassis type (IP20) drive to an enclosed wall-mounted type (UL Type 1) drive.
Braking Resistor Installation Attachment	EZZ020805A	To install a braking resistor to a drive.
External Mounting Attachment for Braking Unit Fin	EZZ021711A	To install the heatsink for the braking unit outside of the control panel.

Table 9.58 Engineering Tools

Name	Model	Purpose
DriveWizard	-	To use a PC to configure drives and manage parameters.
DriveWorksEZ	-	To use a PC to do advanced drive programming.

Table 9.59 Option Cards

Name	Model	Purpose	Document No.
Complementary Type PG	PG-B3	<p>This option is for use with CL-V/f and OLV control methods. The drive detects motor rotation speed from the pulse generator as feedback. The drive can then enable control of the output frequency keep a constant motor speed.</p> <ul style="list-style-type: none"> <li>• Complementary output PG support</li> <li>• A, B, and Z pulse (Three-phase pulse) input</li> <li>• Maximum input frequency: 50 kHz</li> <li>• Pulse monitor output: Open-collector (24 V, maximum of 30 mA)</li> <li>• Encoder power supply: 12 V, maximum 200 mA current.</li> </ul>	TOBPC73060075
Motor PG Feedback Line Driver Interface	PG-X3	<p>This option is for use with CLV, CL-V/f, and CLV/PM control methods. The drive detects motor rotation speed from the pulse generator as feedback. The drive can then enable control of the output frequency keep a constant motor speed.</p> <ul style="list-style-type: none"> <li>• RS-422 output encoder support</li> <li>• A, B, and Z pulse (differential pulse) input</li> <li>• Maximum input frequency: 300 kHz</li> <li>• Pulse monitor: Equivalent to RS-422 level</li> <li>• Encoder voltage output: 5 V or 12V, maximum 200 mA current</li> </ul>	TOBPC73060076
Encoder Type (EnDat)	PG-F3	<p>This option is for use with CLV/PM control method. The drive detects motor rotation speed from the pulse generator as feedback. The drive can then enable control of the output frequency keep a constant motor speed.</p> <ul style="list-style-type: none"> <li>• Supports EnDat 2.1/01, EnDat 2.2/01, EnDat 2.2/22 models from HEIDENHAIN</li> <li>• Supports HIPERFACE models from SICK STEGMANN</li> <li>• Maximum input frequency: 20 kHz (use for low-speed applications, for example gearless motors)</li> </ul> <p><b>Note:</b> EnDat 2.2/22 has no limits on input frequencies.</p> <ul style="list-style-type: none"> <li>• Cable length: Maximum of 20 m (65.6 ft) for encoders and maximum of 30 m (98.4 ft) for pulse monitors</li> <li>• Pulse monitor: Equivalent to RS-422 level</li> </ul> <p><b>Note:</b> You cannot use EnDat 2.2/22.</p> <ul style="list-style-type: none"> <li>• Encoder voltage output: 5 V at a maximum current of 330 mA, or 8 V at a maximum current of 150 mA</li> </ul> <p><b>Note:</b> Use these types of encoder cables:</p> <ul style="list-style-type: none"> <li>• EnDat 2.1/01 and EnDat 2.2/01: HEIDENHAIN 17-pin cables</li> <li>• EnDat 2.2/22: HEIDENHAIN 8-pin cables</li> <li>• HIPERFACE: SICK STEGMANN 8-pin cables</li> </ul>	TOBPC73060077
Resolver Interface	PG-RT3	<p>To connect resolvers that are electrically compatible with resolver model TS2640N321E64 from Tamagawa Seiki Co., Ltd. These are the typical electrical characteristics of model TS2640N321E64:</p> <ul style="list-style-type: none"> <li>• Resolver motor excitation voltage: 10 Vac rms at 10 kHz</li> <li>• Transformation ratio [K]: 0.5 ±5%</li> <li>• Resolver input current: 100 mA rms</li> <li>• Cable length: 10 m (32.8 ft) maximum. 100 m (328 ft) maximum with SS5 or SS7 series motors from Yaskawa Motor Co., Ltd. and encoder cables from Yaskawa Controls Co., Ltd.)</li> </ul> <p>This option is for use with CLV and CLV/PM control methods.</p>	TOBPC73060087

Name	Model	Purpose	Document No.
Analog Input	AI-A3	To configure very accurate analog references at high resolution. <ul style="list-style-type: none"> <li>• Input signal level: -10 Vdc to +10 Vdc (20 kΩ) at 4 mA to 20 mA (250 Ω)</li> <li>• Input channel: 3 channels Use a DIP switch to select voltage input or current input.</li> <li>• Input resolution <ul style="list-style-type: none"> <li>– Voltage input: 13 bits (1/8192) + encoding</li> <li>– Current input: 1/4096</li> </ul> </li> </ul>	TOBPC73060078
Analog Monitor	AO-A3	To use analog signals to monitor the drive output frequency and output current. <ul style="list-style-type: none"> <li>• Output resolution: 11 bits (1/2048) + encoding</li> <li>• Output voltage: -10 Vdc to +10 Vdc (non-insulated)</li> <li>• Output channels: 2 channels</li> </ul>	TOBPC73060079
Digital Inputs	DI-A3	To use digital speed references and MFDI with a maximum 16 bits of resolution. <ul style="list-style-type: none"> <li>• Input signals: Binary, 16 bits: BCD4 digits + SIGN signal + SET signal Use parameters to select 6 bits, 8 bits, or 12 bits.</li> <li>• Input voltage: 24 V (insulated)</li> <li>• Input current: 8 mA</li> </ul>	TOBPC73060080
Digital Output	DO-A3	To output insulated digital signals and monitor the operation status of the drive (alarm signals and detecting zero speed). Type of output: <ul style="list-style-type: none"> <li>• Photocoupler relays: 6 channels (48 V, 50 mA maximum)</li> <li>• Relay contact output: 2 channels (250 Vac at 1 A or less, 30 Vdc at 1 A or less)</li> </ul>	TOBPC73060081
PROFIBUS-DP	SI-P3	This option uses the host controller over PROFIBUS-DP communication to: <ul style="list-style-type: none"> <li>• Operate and stop the drive</li> <li>• Set and view parameters</li> <li>• Monitor output frequency, output current, and other statuses</li> </ul>	TOBPC73060082 SIEPC73060082
CC-Link	SI-C3	This option uses the host controller over CC-Link communication to: <ul style="list-style-type: none"> <li>• Operate and stop the drive</li> <li>• Set and view parameters</li> <li>• Monitor output frequency, output current, and other statuses</li> </ul>	TOBPC73060083 SIEPC73060083
DeviceNet	SI-N3	This option uses the host controller over DeviceNet communication to: <ul style="list-style-type: none"> <li>• Operate and stop the drive</li> <li>• Set and view parameters</li> <li>• Monitor output frequency, output current, and other statuses</li> </ul> <p><b>Note:</b> The drive is compatible with option software versions 1114 and later.</p>	TOBPC73060084 SIEPC73060084
CANopen	SI-S3	This option uses the host controller over CANopen communication to: <ul style="list-style-type: none"> <li>• Operate and stop the drive</li> <li>• Set and view parameters</li> <li>• Monitor output frequency, output current, and other statuses</li> </ul>	TOBPC73060085 SIEPC73060085

## 9.9 Peripheral Devices and Options

Name	Model	Purpose	Document No.
MECHATROLINK-II	SI-T3	This option uses the host controller over MECHATROLINK-II communication to: <ul style="list-style-type: none"> <li>Operate and stop the drive</li> <li>Set and view parameters</li> <li>Monitor output frequency, output current, and other statuses</li> </ul> <b>Note:</b> The drive is compatible with option software versions 6108 and later.	TOBPC73060086 SIEPC73060086
MECHATROLINK-III	SI-ET3	This option uses the host controller over MECHATROLINK-III communication to: <ul style="list-style-type: none"> <li>Operate and stop the drive</li> <li>Set and view parameters</li> <li>Monitor output frequency, output current, and other statuses</li> </ul> <b>Note:</b> The drive is compatible with option software versions 6202 and later.	TOBPC73060088 SIEPC73060088
EtherNet/IP	SI-EN3	This option uses the host controller over EtherNet/IP communication to: <ul style="list-style-type: none"> <li>Operate and stop the drive</li> <li>Set and view parameters</li> <li>Monitor output frequency, output current, and other statuses</li> </ul>	*1
Modbus TCP/IP	SI-EM3	This option is used to perform the following operations using the host controller over Modbus TCP/IP communication. <ul style="list-style-type: none"> <li>Operating and stopping the drive</li> <li>Set and view parameters</li> <li>Monitoring output frequency, output current, and similar</li> </ul>	*1
LONWORKS	SI-W3	This option uses the host controller over LONWORKS communication to: <ul style="list-style-type: none"> <li>Operate and stop the drive</li> <li>Set and view parameters</li> <li>Monitor output frequency, output current, and other statuses</li> </ul>	*1
PROFINET	SI-EP3	This option uses the host controller over PROFINET communication to: <ul style="list-style-type: none"> <li>Operate and stop the drive</li> <li>Set and view parameters</li> <li>Monitor output frequency, output current, and other statuses</li> </ul>	TOBPC73060089 SIEPC73060089

\*1 Contact Yaskawa or your nearest sales representative for more information.

**Table 9.60 Types of Option Cards and Connectors**

Option PCB	Available Connector Ports	Number of Options Permitted
PG-B3, PG-X3	CN5-C (CN5-B)	2 *1
PG-F3 *2 and PG-RT3 *2	CN5-C	1
AO-A3, DO-A3	CN5-A, B, and C	1
AI-A3 *3, DI-A3 *3, SI-C3, SI-EM3, SI-EN3, SI-EP3 SI-ET3, SI-N3, SI-P3, SI-S3, SI-T3, SI-W3	CN5-A	1

\*1 To connect only one PG option card, use the CN5-C connector. To connect two PG option cards, use the CN5-C and CN5-B connectors.

\*2 If you use the motor switching function, you cannot use this option.

\*3 To use AI-A3 and DI-A3 input statuses as monitors, connect the option cards to one of CN5-A, CN5-B, or CN5-C. Use U1-21, U1-22, and U1-23 to confirm the AI-A3 input status. Use U1-17 to confirm the DI-A3 input status.

## Parameter List

---

10.1	Section Safety .....	496
10.2	How to Read the Parameter List .....	497
10.3	Parameter Groups .....	498
10.4	A: Initialization Parameters .....	500
10.5	b: Application .....	502
10.6	C: Tuning .....	513
10.7	d: Reference Settings .....	519
10.8	E: Motor Parameters .....	525
10.9	F: Options .....	531
10.10	H: Terminal Functions .....	546
10.11	L: Protection Functions .....	568
10.12	n: Special Adjustment .....	579
10.13	o: Keypad-Related Settings .....	586
10.14	q: DriveWorksEZ Parameters .....	593
10.15	r: DWEZ Connection 1-20 .....	594
10.16	T: Motor Tuning .....	595
10.17	U: Monitors .....	599
10.18	Parameters that Change from the Default Settings with A1-02 [Control Method Selection] .....	614
10.19	E3-01 [Motor 2 Control Mode] Dependent Parameters .....	620
10.20	Parameters Changed by E1-03 [V/f Pattern Selection] .....	621
10.21	Defaults by Drive Model and Duty Rating ND/HD .....	623
10.22	Parameters Changed by PM Motor Code Selection .....	647

## 10.1 Section Safety

 **DANGER**










**Do not ignore the safety messages in this manual. The operating company is responsible for injuries or equipment damage caused from ignoring the messages in this manual.**

Failure to obey the safety messages will cause death or serious injury.



## 10.2 How to Read the Parameter List

### ◆ Icons and Terms that Identify Parameters and Control Modes

Icon	Description
	The parameter is available when operating the drive with V/f Control.
	The parameters is available when operating the drive with Closed Loop V/f Control.
	The parameter is available when operating the drive with Open Loop Vector Control.
	The parameter is available when operating the drive with Closed Loop Vector Control.
	The parameter is available when operating the drive with Advanced Open Loop Vector Control.
	The parameter is available when operating the drive with Open Loop Vector Control for PM.
	The parameter is available when operating the drive with Advanced Open Loop Vector Control for PM.
	The parameter is available when operating the drive with Closed Loop Vector Control for PM.
	The parameter is available when operating the drive with EZ Open Loop Vector Control.
Hex.	Hexadecimal numbers that represent MEMOBUS addresses to change parameters over network communication.
RUN	The parameter can be changed settings during run.
Expert	The parameter that is available in Expert Mode only. <sup>*1</sup>

\*1 Set  $A1-01 = 3$  [*Access Level Selection = Expert Level*] to display and set Expert Mode parameters on the keypad.

**Note:**

Gray icons identify parameters that are not available in the specified control method.

## 10.3 Parameter Groups

Represents the type of product parameters.

Parameters	Name
A1	Initialization
A2	User Parameters
b1	Operation Mode Selection
b2	DC Injection Braking and Short Circuit Braking
b3	Speed Search
b4	Timer Function
b5	PID Control
b6	Dwell Function
b7	Droop Control
b8	Energy Saving
b9	Zero Servo
C1	Accel & Decel Time
C2	S-Curve Characteristics
C3	Slip Compensation
C4	Torque Compensation
C5	Auto Speed Regulator (ASR)
C6	Duty & Carrier Frequency
d1	Frequency Reference
d2	Reference Limits
d3	Jump Frequency
d4	Frequency Ref Up/Down & Hold
d5	Torque Control
d6	Field Weakening /Forcing
d7	Offset Frequency
E1	V/f Pattern for Motor 1
E2	Motor Parameters
E3	V/f Pattern for Motor 2
E4	Motor 2 Parameters
E5	PM Motor Settings
E9	Motor Setting
F1	PG Option Setup (Encoder)
F2	Analog Input Option
F3	Digital Input Option
F4	Analog Output Option
F5	Digital Output Option
F6	Communication Options
F7	Ethernet Options
H1	Digital Inputs
H2	Digital Outputs

Parameters	Name
H3	Analog Inputs
H4	Analog Outputs
H5	Modbus Communication
H6	Pulse Train Input/Output
H7	Virtual Inputs / Outputs
L1	Motor Protection
L2	Power Loss Ride Through
L3	Stall Prevention
L4	Speed Detection
L5	Fault Restart
L6	Torque Detection
L7	Torque Limit
L8	Drive Protection
L9	Drive Protection 2
n1	Hunting Prevention
n2	Auto Freq Regulator (AFR)
n3	High Slip/Overexcite Braking
n4	Adv Open Loop Vector Tune
n5	Feed Forward Control
n6	Online Tuning
n7	EZ Drive
n8	PM Motor Control Tuning
o1	Keypad Display
o2	Keypad Operation
o3	Copy Keypad Function
o4	Maintenance Monitors
o5	Log Function
q	DriveWorksEZ Parameters
r	DriveWorksEZ Connections
T0	Tuning Mode Selection
T1	InductionMotor Auto-Tuning
T2	PM Motor Auto-Tuning
T3	ASR and Inertia Tuning
T4	EZ Tuning
U1	Operation Status Monitors
U2	Fault Trace
U3	Fault History
U4	Maintenance Monitors
U5	PID Monitors

Parameters	Name
U6	Operation Status Monitors

Parameters	Name
U8	DriveWorksEZ Monitors

## 10.4 A: Initialization Parameters

### ◆ A1: Initialization

No. (Hex.)	Name	Description	Default (Range)	Ref.
A1-00 (0100) RUN	Language Selection	<p><b>V/f</b> <b>CL-V/f</b> <b>OLV</b> <b>CLV</b> <b>AOLV</b> <b>OLV/PM</b> <b>AOLV/PM</b> <b>CLV/PM</b> <b>EZOLV</b></p> <p>Sets the language for the LCD keypad.</p> <p><b>Note:</b> When you initialize the drive with parameter <i>A1-03 [Initialize Parameters]</i>, the drive will not reset this parameter.</p> <p>0 : English 1 : Japanese 2 : German 3 : French 4 : Italian 5 : Spanish 6 : Portuguese 7 : Chinese 8 : Czech 9 : Russian 10 : Turkish 11 : Polish 12 : Greek</p>	0 (0 - 12)	675
A1-01 (0101) RUN	Access Level Selection	<p><b>V/f</b> <b>CL-V/f</b> <b>OLV</b> <b>CLV</b> <b>AOLV</b> <b>OLV/PM</b> <b>AOLV/PM</b> <b>CLV/PM</b> <b>EZOLV</b></p> <p>Sets user access to parameters. The access level controls which parameters the keypad will display, and which parameters the user can set.</p> <p>0 : Operation Only 1 : User Parameters 2 : Advanced Level 3 : Expert Level</p>	2 (0 - 3)	675
A1-02 (0102)	Control Method Selection	<p><b>V/f</b> <b>CL-V/f</b> <b>OLV</b> <b>CLV</b> <b>AOLV</b> <b>OLV/PM</b> <b>AOLV/PM</b> <b>CLV/PM</b> <b>EZOLV</b></p> <p>Sets the control method for the drive application and the motor.</p> <p>0 : V/f Control 1 : V/f Control with Encoder 2 : Open Loop Vector 3 : Closed Loop Vector 4 : Advanced Open Loop Vector 5 : PM Open Loop Vector 6 : PM Advanced Open Loop Vector 7 : PM Closed Loop Vector 8 : EZ Vector Control</p>	0 (0 - 8)	676
A1-03 (0103)	Initialize Parameters	<p><b>V/f</b> <b>CL-V/f</b> <b>OLV</b> <b>CLV</b> <b>AOLV</b> <b>OLV/PM</b> <b>AOLV/PM</b> <b>CLV/PM</b> <b>EZOLV</b></p> <p>Sets parameters to default values.</p> <p>0 : No Initialization 1110 : User Initialization 2220 : 2-Wire Initialization 3330 : 3-Wire Initialization</p>	0 (0 - 3330)	677
A1-04 (0104)	Password	<p><b>V/f</b> <b>CL-V/f</b> <b>OLV</b> <b>CLV</b> <b>AOLV</b> <b>OLV/PM</b> <b>AOLV/PM</b> <b>CLV/PM</b> <b>EZOLV</b></p> <p>Entry point for the password set in <i>A1-05 [Password Setting]</i>. The user can view the settings of parameters that are locked without entering the password. Enter the correct password in this parameter to change parameter settings.</p>	0000 (0000 - 9999)	678
A1-05 (0105)	Password Setting	<p><b>V/f</b> <b>CL-V/f</b> <b>OLV</b> <b>CLV</b> <b>AOLV</b> <b>OLV/PM</b> <b>AOLV/PM</b> <b>CLV/PM</b> <b>EZOLV</b></p> <p>Set the password to lock parameters and prevent changes to parameter settings. Enter the correct password in <i>A1-04 [Password]</i> to unlock parameters and accept changes.</p>	0000 (0000 - 9999)	679

No. (Hex.)	Name	Description	Default (Range)	Ref.
A1-06 (0127)	Application Preset	<p><b>V/f</b> <b>CL-V/f</b> <b>OLV</b> <b>CLV</b> <b>AOLV</b> <b>OLV/PM</b> <b>AOLV/PM</b> <b>CLV/PM</b> <b>EZOLV</b></p> <p>Sets the drive to operate in selected application conditions.            0 : General-purpose            1 : Water Supply Pump 2            2 : Conveyor            3 : Exhaust Fan            4 : HVAC Fan            5 : Air Compressor            6 : Crane (Hoist)            7 : Crane (Traveling)</p>	0 (0 - 7)	679
A1-07 (0128)	DriveWorksEZ Function Selection	<p><b>V/f</b> <b>CL-V/f</b> <b>OLV</b> <b>CLV</b> <b>AOLV</b> <b>OLV/PM</b> <b>AOLV/PM</b> <b>CLV/PM</b> <b>EZOLV</b></p> <p>Sets the drive to operate with DriveWorksEZ.            0 : DWEZ Disabled            1 : DWEZ Enabled            2 : Enabled/Disabled wDigital Input</p>	0 (0 - 2)	695
A1-11 (111D) Expert	Firmware Update Lock	<p><b>V/f</b> <b>CL-V/f</b> <b>OLV</b> <b>CLV</b> <b>AOLV</b> <b>OLV/PM</b> <b>AOLV/PM</b> <b>CLV/PM</b> <b>EZOLV</b></p> <p>This function locks the drive firmware. When enabled, users cannot flash new drive firmware.            0 : Disabled            1 : Enabled</p>	0 (0, 1)	695
A1-12 (1564)	Bluetooth ID	<p><b>V/f</b> <b>CL-V/f</b> <b>OLV</b> <b>CLV</b> <b>AOLV</b> <b>OLV/PM</b> <b>AOLV/PM</b> <b>CLV/PM</b> <b>EZOLV</b></p> <p>Sets the password necessary to use Bluetooth to control the drive with a mobile device.</p>	- (0000 - 9999)	696

## ◆ A2: User Parameters

No. (Hex.)	Name	Description	Default (Range)	Ref.
A2-01 to A2-32 (0106 - 0125)	User Parameters 1 to 32	<p><b>V/f</b> <b>CL-V/f</b> <b>OLV</b> <b>CLV</b> <b>AOLV</b> <b>OLV/PM</b> <b>AOLV/PM</b> <b>CLV/PM</b> <b>EZOLV</b></p> <p>You can select a maximum of 32 parameters for the drive and set them to parameters <i>A2-01 to A2-32</i>. The [User Parameters] section of the keypad main menu shows the set parameters. You can immediately access these set parameters.</p> <p><b>Note:</b>            Settings for <i>A2-01 to A2-32</i> change when the <i>A1-06 [Application Preset]</i> value changes.</p>	Parameters in General-Purpose Setup Mode (Determined by A1-07)	696
A2-33 (0126)	User Parameter Auto Selection	<p><b>V/f</b> <b>CL-V/f</b> <b>OLV</b> <b>CLV</b> <b>AOLV</b> <b>OLV/PM</b> <b>AOLV/PM</b> <b>CLV/PM</b> <b>EZOLV</b></p> <p>Sets the automatic save feature for changes to parameters <i>A2-17 to A2-32 [User Parameters 17 to 32]</i>.            0 : Disabled: Manual Entry Required            1 : Enabled: Auto Save Recent Parm</p>	Determined by A1-06 (0, 1)	696

## 10.5 b: Application

### ◆ b1: Operation Mode Selection

No. (Hex.)	Name	Description	Default (Range)	Ref.
b1-01 (0180)	Frequency Reference Selection 1	<p><b>V/f</b> <b>CL-V/f</b> <b>OLV</b> <b>CLV</b> <b>AOLV</b> <b>OLV/PM</b> <b>AOLV/PM</b> <b>CLV/PM</b> <b>EZOLV</b></p> <p>Sets the input method for the frequency reference.</p> <p>0 : Keypad 1 : Analog Input 2 : Memobus/Modbus Communications 3 : Option PCB 4 : Pulse Train Input</p>	1 (0 - 4)	697
b1-02 (0181)	Run Command Selection 1	<p><b>V/f</b> <b>CL-V/f</b> <b>OLV</b> <b>CLV</b> <b>AOLV</b> <b>OLV/PM</b> <b>AOLV/PM</b> <b>CLV/PM</b> <b>EZOLV</b></p> <p>Sets the input method for the Run command.</p> <p>0 : Keypad 1 : Digital Input 2 : Memobus/Modbus Communications 3 : Option PCB</p>	1 (0 - 3)	699
b1-03 (0182)	Stopping Method Selection	<p><b>V/f</b> <b>CL-V/f</b> <b>OLV</b> <b>CLV</b> <b>AOLV</b> <b>OLV/PM</b> <b>AOLV/PM</b> <b>CLV/PM</b> <b>EZOLV</b></p> <p>Sets the method to stop the motor after removing a Run command or entering a Stop command.</p> <p><b>Note:</b> The setting range is 0, 1, and 3 when <i>A1-02 = 3, 4, 5, 6, 7, or 8</i> [<i>Control Method Selection = Closed Loop Vector, Advanced Open Loop Vector, PM Open Loop Vector, PM Advanced Open Loop Vector, PM Closed Loop Vector, or EZ Vector Control</i>].</p> <p>0 : Ramp to Stop 1 : Coast to Stop 2 : DC Injection Braking to Stop 3 : Coast to Stop with Timer 9 : Stop with Constant Distance</p>	0 (0 - 3, 9)	699
b1-04 (0183)	Reverse Operation Selection	<p><b>V/f</b> <b>CL-V/f</b> <b>OLV</b> <b>CLV</b> <b>AOLV</b> <b>OLV/PM</b> <b>AOLV/PM</b> <b>CLV/PM</b> <b>EZOLV</b></p> <p>Sets the reverse operation function. Disable reverse operation in fan or pump applications where reverse rotation is dangerous.</p> <p>0 : Reverse Enabled 1 : Reverse Disabled</p>	0 (0, 1)	703
b1-05 (0184)	Operation Below Minimum Freq	<p><b>V/f</b> <b>CL-V/f</b> <b>OLV</b> <b>CLV</b> <b>AOLV</b> <b>OLV/PM</b> <b>AOLV/PM</b> <b>CLV/PM</b> <b>EZOLV</b></p> <p>Sets the drive operation when the frequency reference decreases to less than the value set in <i>E1-09</i> [<i>Minimum Output Frequency</i>].</p> <p>0 : Operate at Frequency Reference 1 : Baseblock (Motor Coasts) 2 : Operate at Minimum Frequency 3 : Operate at Zero Speed</p>	0 (0 - 3)	703
b1-06 (0185)	Digital Input Reading	<p><b>V/f</b> <b>CL-V/f</b> <b>OLV</b> <b>CLV</b> <b>AOLV</b> <b>OLV/PM</b> <b>AOLV/PM</b> <b>CLV/PM</b> <b>EZOLV</b></p> <p>Sets the number of times that the drive reads the sequence input command to prevent problems from electrical interference.</p> <p>0 : Single Scan 1 : Double Scan</p>	1 (0, 1)	704
b1-07 (0186)	LOCAL/REMOTE Run Selection	<p><b>V/f</b> <b>CL-V/f</b> <b>OLV</b> <b>CLV</b> <b>AOLV</b> <b>OLV/PM</b> <b>AOLV/PM</b> <b>CLV/PM</b> <b>EZOLV</b></p> <p>Sets drive response to an existing Run command when the drive receives a second Run command from a different location.</p> <p>0 : Disregard Existing RUN Command 1 : Accept Existing RUN Command</p>	0 (0, 1)	705
b1-08 (0187)	Run Command Select in PRG Mode	<p><b>V/f</b> <b>CL-V/f</b> <b>OLV</b> <b>CLV</b> <b>AOLV</b> <b>OLV/PM</b> <b>AOLV/PM</b> <b>CLV/PM</b> <b>EZOLV</b></p> <p>Sets the conditions for the drive to accept a Run command entered from an external source when using the keypad to set parameters.</p> <p>0 : Disregard RUN while Programming 1 : Accept RUN while Programming 2 : Allow Programming Only at Stop</p>	0 (0 - 2)	705

No. (Hex.)	Name	Description	Default (Range)	Ref.
b1-14 (01C3)	Phase Order Selection	<b>V/f</b> <b>CL-V/f</b> <b>OLV</b> <b>CLV</b> <b>AOLV</b> <b>OLV/PM</b> <b>AOLV/PM</b> <b>CLV/PM</b> <b>EZOLV</b> Sets the phase order for output terminals U/T1, V/T2, and W/T3. This parameter can align the Forward Run command from the drive and the forward direction of the motor without changing wiring. 0 : Standard 1 : Switch Phase Order	0 (0, 1)	706
b1-15 (01C4)	Frequency Reference Selection 2	<b>V/f</b> <b>CL-V/f</b> <b>OLV</b> <b>CLV</b> <b>AOLV</b> <b>OLV/PM</b> <b>AOLV/PM</b> <b>CLV/PM</b> <b>EZOLV</b> Sets the input method for frequency reference 2. 0 : Keypad 1 : Analog Input 2 : Memobus/Modbus Communications 3 : Option PCB 4 : Pulse Train Input	0 (0 - 4)	706
b1-16 (01C5)	Run Command Selection 2	<b>V/f</b> <b>CL-V/f</b> <b>OLV</b> <b>CLV</b> <b>AOLV</b> <b>OLV/PM</b> <b>AOLV/PM</b> <b>CLV/PM</b> <b>EZOLV</b> Sets the input method for Run Command 2 when the user switches the control circuit terminals ON/OFF to change the Run command source. 0 : Keypad 1 : Digital Input 2 : Memobus/Modbus Communications 3 : Option PCB	0 (0 - 3)	708
b1-17 (01C6)	Run Command at Power Up	<b>V/f</b> <b>CL-V/f</b> <b>OLV</b> <b>CLV</b> <b>AOLV</b> <b>OLV/PM</b> <b>AOLV/PM</b> <b>CLV/PM</b> <b>EZOLV</b> Sets drive response when energizing a drive that has an external Run command. Set this parameter in applications where energizing or de-energizing the drive enables the Run command. 0 : Disregard Existing RUN Command 1 : Accept Existing RUN Command	0 (0, 1)	709
b1-21 (0748) Expert	CLV Start Selection	<b>V/f</b> <b>CL-V/f</b> <b>OLV</b> <b>CLV</b> <b>AOLV</b> <b>OLV/PM</b> <b>AOLV/PM</b> <b>CLV/PM</b> <b>EZOLV</b> Sets drive response to a Run command when $A1-02 = 3$ or $7$ [Control Method Selection = Closed Loop Vector or PM Closed Loop Vector]. Usually it is not necessary to change this setting. 0 : Reject RUN if $b2-01 < U1-05 < E1-09$ 1 : Accept RUN Command at Any Speed	0 (0, 1)	709
b1-35 (1117) Expert	Digital Input Deadband Time	<b>V/f</b> <b>CL-V/f</b> <b>OLV</b> <b>CLV</b> <b>AOLV</b> <b>OLV/PM</b> <b>AOLV/PM</b> <b>CLV/PM</b> <b>EZOLV</b> Sets the deadband time for MFDIs.	0.0 ms (0.0 to 100.0 ms)	709

## ◆ b2: DC Injection Braking and Short Circuit Braking

No. (Hex.)	Name	Description	Default (Range)	Ref.
b2-01 (0189)	DC Injection/Zero SpeedThreshold	<b>V/f</b> <b>CL-V/f</b> <b>OLV</b> <b>CLV</b> <b>AOLV</b> <b>OLV/PM</b> <b>AOLV/PM</b> <b>CLV/PM</b> <b>EZOLV</b> Sets the frequency to start DC Injection Braking, Short Circuit Braking, and Zero Servo. <b>Note:</b> This parameter is available when $b1-03 = 0$ [Stopping Method Selection = Ramp to Stop].	Determined by A1-02 (0.0 - 10.0 Hz)	710
b2-02 (018A)	DC Injection Braking Current	<b>V/f</b> <b>CL-V/f</b> <b>OLV</b> <b>CLV</b> <b>AOLV</b> <b>OLV/PM</b> <b>AOLV/PM</b> <b>CLV/PM</b> <b>EZOLV</b> Sets the DC Injection Braking current as a percentage of the drive rated current.	50% (0 - 100%)	711
b2-03 (018B)	DC Inject Braking Time at Start	<b>V/f</b> <b>CL-V/f</b> <b>OLV</b> <b>CLV</b> <b>AOLV</b> <b>OLV/PM</b> <b>AOLV/PM</b> <b>CLV/PM</b> <b>EZOLV</b> Sets the DC Injection Braking Time at stop. Sets the zero speed control at stop in CLV, AOLV, or CLV/PM.	A1-02 = 4: 0.03 s Other than A1-02 = 4: 0.00 s (0.00 - 10.00 s)	711
b2-04 (018C)	DC Inject Braking Time at Stop	<b>V/f</b> <b>CL-V/f</b> <b>OLV</b> <b>CLV</b> <b>AOLV</b> <b>OLV/PM</b> <b>AOLV/PM</b> <b>CLV/PM</b> <b>EZOLV</b> Sets the DC Injection Braking Time at stop. Sets the zero speed control at stop in CLV, AOLV, or CLV/PM.	Determined by A1-02 (0.00 - 10.00 s)	711

No. (Hex.)	Name	Description	Default (Range)	Ref.
b2-08 (0190)	Magnetic Flux Compensation Value	<input type="checkbox"/> V/f <input type="checkbox"/> CL-V/f <input checked="" type="checkbox"/> OLV <input type="checkbox"/> CLV <input type="checkbox"/> AOLV <input type="checkbox"/> OLV/PM <input type="checkbox"/> AOLV/PM <input type="checkbox"/> CLV/PM <input type="checkbox"/> EZOLV Sets how much current the drive injects when DC Injection Braking at Start starts (Initial Excitation) as a percentage of E2-03 [Motor No-Load Current].	0% (0 - 1000%)	711
b2-12 (01BA)	Short Circuit Brake Time @ Start	<input type="checkbox"/> V/f <input type="checkbox"/> CL-V/f <input type="checkbox"/> OLV <input type="checkbox"/> CLV <input type="checkbox"/> AOLV <input checked="" type="checkbox"/> OLV/PM <input checked="" type="checkbox"/> AOLV/PM <input type="checkbox"/> CLV/PM <input checked="" type="checkbox"/> EZOLV Sets the Short Circuit Braking time at start.	0.00 s (0.00 - 25.50 s)	712
b2-13 (01BB)	Short Circuit Brake Time @ Stop	<input type="checkbox"/> V/f <input type="checkbox"/> CL-V/f <input type="checkbox"/> OLV <input type="checkbox"/> CLV <input type="checkbox"/> AOLV <input checked="" type="checkbox"/> OLV/PM <input checked="" type="checkbox"/> AOLV/PM <input type="checkbox"/> CLV/PM <input checked="" type="checkbox"/> EZOLV Sets the Short Circuit Braking time at stop.	A1-02 = 8: 0.00 s Other than A1-02 = 8: 0.50 s (0.00 - 25.50 s)	712
b2-18 (0177)	Short Circuit Braking Current	<input type="checkbox"/> V/f <input type="checkbox"/> CL-V/f <input type="checkbox"/> OLV <input type="checkbox"/> CLV <input type="checkbox"/> AOLV <input checked="" type="checkbox"/> OLV/PM <input checked="" type="checkbox"/> AOLV/PM <input type="checkbox"/> CLV/PM <input checked="" type="checkbox"/> EZOLV Sets the Short Circuit Braking Current as a percentage of the motor rated current.	100.0% (0.0 - 200.0%)	712

◆ b3: Speed Search

No. (Hex.)	Name	Description	Default (Range)	Ref.
b3-01 (0191)	Speed Search at Start Selection	<input type="checkbox"/> V/f <input type="checkbox"/> CL-V/f <input checked="" type="checkbox"/> OLV <input type="checkbox"/> CLV <input type="checkbox"/> AOLV <input checked="" type="checkbox"/> OLV/PM <input checked="" type="checkbox"/> AOLV/PM <input type="checkbox"/> CLV/PM <input checked="" type="checkbox"/> EZOLV Sets the Speed Search at Start function where the drive will perform Speed Search with each Run command. 0 : Disabled 1 : Enabled	Determined by A1-02 (0, 1)	716
b3-02 (0192)	SpeedSearch Deactivation Current	<input type="checkbox"/> V/f <input type="checkbox"/> CL-V/f <input checked="" type="checkbox"/> OLV <input type="checkbox"/> CLV <input type="checkbox"/> AOLV <input type="checkbox"/> OLV/PM <input type="checkbox"/> AOLV/PM <input type="checkbox"/> CLV/PM <input type="checkbox"/> EZOLV Sets the current level that stops Speed Search as a percentage of the drive rated output current. Usually it is not necessary to change this setting.	Determined by A1-02 (0 - 200%)	716
b3-03 (0193)	Speed Search Deceleration Time	<input type="checkbox"/> V/f <input type="checkbox"/> CL-V/f <input checked="" type="checkbox"/> OLV <input type="checkbox"/> CLV <input type="checkbox"/> AOLV <input type="checkbox"/> OLV/PM <input type="checkbox"/> AOLV/PM <input type="checkbox"/> CLV/PM <input type="checkbox"/> EZOLV Sets the deceleration time during Speed Search operation. Set the length of time to decelerate from the maximum output frequency to the minimum output frequency.	2.0 s (0.1 - 10.0 s)	716
b3-04 (0194)	V/f Gain during Speed Search	<input type="checkbox"/> V/f <input type="checkbox"/> CL-V/f <input type="checkbox"/> OLV <input type="checkbox"/> CLV <input type="checkbox"/> AOLV <input type="checkbox"/> OLV/PM <input type="checkbox"/> AOLV/PM <input type="checkbox"/> CLV/PM <input type="checkbox"/> EZOLV Sets the ratio used to reduce the V/f during searches to reduce the output current during speed searches.	Determined by o2-04 (10 - 100)	717
b3-05 (0195)	Speed Search Delay Time	<input type="checkbox"/> V/f <input type="checkbox"/> CL-V/f <input checked="" type="checkbox"/> OLV <input type="checkbox"/> CLV <input type="checkbox"/> AOLV <input checked="" type="checkbox"/> OLV/PM <input checked="" type="checkbox"/> AOLV/PM <input type="checkbox"/> CLV/PM <input checked="" type="checkbox"/> EZOLV Sets the Speed Search delay time to activate a magnetic contactor installed between the drive and motor.	0.2 s (0.0 - 100.0 s)	717
b3-06 (0196) Expert	Speed Estimation Current Level 1	<input type="checkbox"/> V/f <input type="checkbox"/> CL-V/f <input checked="" type="checkbox"/> OLV <input type="checkbox"/> CLV <input type="checkbox"/> AOLV <input checked="" type="checkbox"/> OLV/PM <input checked="" type="checkbox"/> AOLV/PM <input type="checkbox"/> CLV/PM <input checked="" type="checkbox"/> EZOLV Sets the level of current that flows to the motor during Speed Estimation Speed Search as a coefficient of the motor rated current. Usually it is not necessary to change this setting.	Determined by o2-04 (0.0 - 2.0)	717
b3-07 (0197) Expert	Speed Estimation Current Level 2	<input type="checkbox"/> V/f <input type="checkbox"/> CL-V/f <input checked="" type="checkbox"/> OLV <input type="checkbox"/> CLV <input type="checkbox"/> AOLV <input type="checkbox"/> OLV/PM <input type="checkbox"/> AOLV/PM <input type="checkbox"/> CLV/PM <input type="checkbox"/> EZOLV Sets the level of current that flows to the motor during Speed Estimation Speed Search as a coefficient of E2-03 [Motor No-Load Current] or E4-03 [Motor 2 Rated No-Load Current]. Usually it is not necessary to change this setting.	1.0 (0.0 - 3.0)	717
b3-08 (0198) Expert	Speed Estimation ACR P Gain	<input type="checkbox"/> V/f <input type="checkbox"/> CL-V/f <input checked="" type="checkbox"/> OLV <input type="checkbox"/> CLV <input type="checkbox"/> AOLV <input checked="" type="checkbox"/> OLV/PM <input checked="" type="checkbox"/> AOLV/PM <input type="checkbox"/> CLV/PM <input checked="" type="checkbox"/> EZOLV Sets the proportional gain for the automatic current regulator during Speed Estimation Speed Search. Also adjusts speed search responsiveness. Usually it is not necessary to change this setting.	A1-02 = 0 through 4: Determined by o2-04, A1-02 = 5, 6, or 8: Determined by A1-02 (0.00 - 6.00)	717
b3-09 (0199) Expert	Speed Estimation ACR I Time	<input type="checkbox"/> V/f <input type="checkbox"/> CL-V/f <input checked="" type="checkbox"/> OLV <input type="checkbox"/> CLV <input type="checkbox"/> AOLV <input checked="" type="checkbox"/> OLV/PM <input checked="" type="checkbox"/> AOLV/PM <input type="checkbox"/> CLV/PM <input checked="" type="checkbox"/> EZOLV Sets the integral time for the automatic current regulator during Speed Estimation Speed Search. Also adjusts speed search responsiveness. Usually it is not necessary to change this setting.	Determined by A1-02 (0.0 - 1000.0 ms)	718
b3-10 (019A) Expert	Speed Estimation Detection Gain	<input type="checkbox"/> V/f <input type="checkbox"/> CL-V/f <input checked="" type="checkbox"/> OLV <input type="checkbox"/> CLV <input type="checkbox"/> AOLV <input type="checkbox"/> OLV/PM <input type="checkbox"/> AOLV/PM <input type="checkbox"/> CLV/PM <input type="checkbox"/> EZOLV Sets the gain to correct estimated frequencies from Speed Estimation Speed Search.	1.05 (1.00 - 1.20)	718



No. (Hex.)	Name	Description	Default (Range)	Ref.
b3-14 (019E)	Bi-directional Speed Search	<input type="checkbox"/> V/f <input type="checkbox"/> CL-V/f <input type="checkbox"/> OLV <input type="checkbox"/> CLV <input type="checkbox"/> AOLV <input type="checkbox"/> OLV/PM <input type="checkbox"/> AOLV/PM <input type="checkbox"/> CLV/PM <input type="checkbox"/> EZOLV Sets the direction of Speed Search to the direction of the frequency reference or in the motor rotation direction as detected by the drive. 0 : Disabled 1 : Enabled	Determined by A1-02 (0, 1)	718
b3-17 (01F0) Expert	Speed Est Retry Current Level	<input type="checkbox"/> V/f <input type="checkbox"/> CL-V/f <input type="checkbox"/> OLV <input type="checkbox"/> CLV <input type="checkbox"/> AOLV <input type="checkbox"/> OLV/PM <input type="checkbox"/> AOLV/PM <input type="checkbox"/> CLV/PM <input type="checkbox"/> EZOLV Sets the current level for the search retry function in Speed Estimation Speed Search as a percentage where drive rated current is a setting value of 100%.	150% (0 - 200%)	718
b3-18 (01F1) Expert	Speed Est Retry Detection Time	<input type="checkbox"/> V/f <input type="checkbox"/> CL-V/f <input type="checkbox"/> OLV <input type="checkbox"/> CLV <input type="checkbox"/> AOLV <input type="checkbox"/> OLV/PM <input type="checkbox"/> AOLV/PM <input type="checkbox"/> CLV/PM <input type="checkbox"/> EZOLV Sets the length of time that the drive will wait to retry Speed Estimation Speed Search when too much current flow stopped the Speed Search.	0.10 s (0.00 - 1.00 s)	718
b3-19 (01F2)	Speed Search Restart Attempts	<input type="checkbox"/> V/f <input type="checkbox"/> CL-V/f <input type="checkbox"/> OLV <input type="checkbox"/> CLV <input type="checkbox"/> AOLV <input type="checkbox"/> OLV/PM <input type="checkbox"/> AOLV/PM <input type="checkbox"/> CLV/PM <input type="checkbox"/> EZOLV Sets the number of times to restart Speed Search if Speed Search does not complete.	3 times (0 - 10 times)	718
b3-24 (01C0)	Speed Search Method Selection	<input type="checkbox"/> V/f <input type="checkbox"/> CL-V/f <input type="checkbox"/> OLV <input type="checkbox"/> CLV <input type="checkbox"/> AOLV <input type="checkbox"/> OLV/PM <input type="checkbox"/> AOLV/PM <input type="checkbox"/> CLV/PM <input type="checkbox"/> EZOLV Sets the Speed Search method when starting the motor or when restoring power after a momentary power loss. 1 : Speed Estimation 2 : Current Detection 2	2 (1, 2)	719
b3-25 (01C8) Expert	Speed Search Wait Time	<input type="checkbox"/> V/f <input type="checkbox"/> CL-V/f <input type="checkbox"/> OLV <input type="checkbox"/> CLV <input type="checkbox"/> AOLV <input type="checkbox"/> OLV/PM <input type="checkbox"/> AOLV/PM <input type="checkbox"/> CLV/PM <input type="checkbox"/> EZOLV Sets the length of time the drive will wait to start the Speed Search Retry function.	0.5 s (0.0 - 30.0 s)	719
b3-26 (01C7) Expert	Direction Determination Level	<input type="checkbox"/> V/f <input type="checkbox"/> CL-V/f <input type="checkbox"/> OLV <input type="checkbox"/> CLV <input type="checkbox"/> AOLV <input type="checkbox"/> OLV/PM <input type="checkbox"/> AOLV/PM <input type="checkbox"/> CLV/PM <input type="checkbox"/> EZOLV Sets the level to find the motor rotation direction. Increase the value if the drive cannot find the direction.	1000 (40 - 60000)	719
b3-27 (01C9) Expert	Speed Search RUN/BB Priority	<input type="checkbox"/> V/f <input type="checkbox"/> CL-V/f <input type="checkbox"/> OLV <input type="checkbox"/> CLV <input type="checkbox"/> AOLV <input type="checkbox"/> OLV/PM <input type="checkbox"/> AOLV/PM <input type="checkbox"/> CLV/PM <input type="checkbox"/> EZOLV Sets the conditions necessary to start Speed Search. 0 : SS Only if RUN Applied Before BB 1 : SS Regardless of RUN/BB Sequence	0 (0, 1)	719
b3-29 (077C) Expert	Speed Search Back-EMF Threshold	<input type="checkbox"/> V/f <input type="checkbox"/> CL-V/f <input type="checkbox"/> OLV <input type="checkbox"/> CLV <input type="checkbox"/> AOLV <input type="checkbox"/> OLV/PM <input type="checkbox"/> AOLV/PM <input type="checkbox"/> CLV/PM <input type="checkbox"/> EZOLV Sets the induced voltage for motors that use Speed Search. The drive will start Speed Search when the motor induced voltage level is the same as the setting value. Usually it is not necessary to change this setting.	10% (0 - 10%)	720
b3-31 (0BC0) Expert	Spd Search Current Reference Lvl	<input type="checkbox"/> V/f <input type="checkbox"/> CL-V/f <input type="checkbox"/> OLV <input type="checkbox"/> CLV <input type="checkbox"/> AOLV <input type="checkbox"/> OLV/PM <input type="checkbox"/> AOLV/PM <input type="checkbox"/> CLV/PM <input type="checkbox"/> EZOLV Sets the current level that decreases the output current during Current Detection Speed Search.	1.50 (1.50 - 3.50)	720
b3-32 (0BC1) Expert	Spd Search Current Complete Lvl	<input type="checkbox"/> V/f <input type="checkbox"/> CL-V/f <input type="checkbox"/> OLV <input type="checkbox"/> CLV <input type="checkbox"/> AOLV <input type="checkbox"/> OLV/PM <input type="checkbox"/> AOLV/PM <input type="checkbox"/> CLV/PM <input type="checkbox"/> EZOLV Sets the current level that completes Speed Search.	1.20 (0.00 - 1.49)	720
b3-33 (0B3F) Expert	Speed Search during Uv Selection	<input type="checkbox"/> V/f <input type="checkbox"/> CL-V/f <input type="checkbox"/> OLV <input type="checkbox"/> CLV <input type="checkbox"/> AOLV <input type="checkbox"/> OLV/PM <input type="checkbox"/> AOLV/PM <input type="checkbox"/> CLV/PM <input type="checkbox"/> EZOLV Sets the function that starts Speed Search at start-up if the drive detects a Uv [ <i>Undervoltage</i> ] when it receives a Run command. 0 : Disabled 1 : Enabled	1 (0, 1)	720
b3-35 (0BC3) Expert	Low Back EMF Detection Level	<input type="checkbox"/> V/f <input type="checkbox"/> CL-V/f <input type="checkbox"/> OLV <input type="checkbox"/> CLV <input type="checkbox"/> AOLV <input type="checkbox"/> OLV/PM <input type="checkbox"/> AOLV/PM <input type="checkbox"/> CLV/PM <input type="checkbox"/> EZOLV Sets the level of induced voltage that the drive must detect to start Speed Search.	10% (5 - 50%)	720
b3-36 (0BC4) Expert	High Back EMF Detection Level	<input type="checkbox"/> V/f <input type="checkbox"/> CL-V/f <input type="checkbox"/> OLV <input type="checkbox"/> CLV <input type="checkbox"/> AOLV <input type="checkbox"/> OLV/PM <input type="checkbox"/> AOLV/PM <input type="checkbox"/> CLV/PM <input type="checkbox"/> EZOLV Sets one of the factors in the formula to prevent drive restarts and cause the drive to enter standby. The drive will enter standby and will not restart when the detected induced voltage of the motor $\geq$ power supply voltage $\times$ b3-36. Usually it is not necessary to change this setting.	0.970 (0.500 - 1.000)	721

No. (Hex.)	Name	Description	Default (Range)	Ref.
b3-54 (3123)	Search Time	Sets the length of time that the drive will run Speed Search.	400 ms (10 - 2000 ms)	721
b3-55 (3124) Expert	Current Increment Time	Sets the length of time that the drive will increase the current from zero current to the setting value of b3-06 [ <i>Speed Estimation Current Level 1</i> ].	10 ms (10 - 2000 ms)	721

#### ◆ b4: Timer Function

No. (Hex.)	Name	Description	Default (Range)	Ref.
b4-01 (01A3)	Timer Function ON-Delay Time	Sets the ON-delay time for the timer input.	0.0 s (0.0 - 3000.0 s)	722
b4-02 (01A4)	Timer Function OFF-Delay Time	Sets the OFF-delay time for the timer input.	0.0 s (0.0 - 3000.0 s)	722
b4-03 (0B30) Expert	Terminal M1-M2 ON-Delay Time	Sets the delay time to activate the contact after the function set in H2-01 activates.	0 ms (0 - 65000 ms)	722
b4-04 (0B31) Expert	Terminal M1-M2 OFF-Delay Time	Sets the delay time to deactivate the contact after the function set in H2-01 deactivates.	0 ms (0 - 65000 ms)	722
b4-05 (0B32) Expert	Terminal M3-M4 ON-Delay Time	Sets the delay time to activate the contact after the function set in H2-02 activates.	0 ms (0 - 65000 ms)	722
b4-06 (0B33) Expert	Terminal M3-M4 OFF-Delay Time	Sets the delay time to deactivate the contact after the function set in H2-02 deactivates.	0 ms (0 - 65000 ms)	723
b4-07 (0B34) Expert	Terminal M5-M6 ON-Delay Time	Sets the delay time to activate the contact after the function set in H2-03 activates.	0 ms (0 - 65000 ms)	723
b4-08 (0B35) Expert	Terminal M5-M6 OFF-Delay Time	Sets the delay time to deactivate the contact after the function set in H2-03 deactivates.	0 ms (0 - 65000 ms)	723

## ◆ b5: PID Control

No. (Hex.)	Name	Description	Default (Range)	Ref.
b5-01 (01A5)	PID Mode Setting	<p><b>V/f</b> <b>CL-V/f</b> <b>OLV</b> <b>CLV</b> <b>AOLV</b> <b>OLV/PM</b> <b>AOLV/PM</b> <b>CLV/PM</b> <b>EZOLV</b></p> <p>Sets the type of PID control.            0 : Disabled            1 : Standard            2 : Standard (D on feedback)            3 : Fref + PID Trim            4 : Fref + PID Trim (D on feedback)            5 : Same as 7series &amp; prior, b5-01=1            6 : Same as 7series &amp; prior, b5-01=2            7 : Same as 7series &amp; prior, b5-01=3            8 : Same as 7series &amp; prior, b5-01=4</p> <p><b>Note:</b>            Use settings 5 to 8 when the drive is a replacement for a previous generation drive.</p>	0 (0 - 8)	729
b5-02 (01A6) RUN	Proportional Gain (P)	<p><b>V/f</b> <b>CL-V/f</b> <b>OLV</b> <b>CLV</b> <b>AOLV</b> <b>OLV/PM</b> <b>AOLV/PM</b> <b>CLV/PM</b> <b>EZOLV</b></p> <p>Sets the proportional gain (P) that is applied to PID input.</p>	1.00 (0.00 - 25.00)	730
b5-03 (01A7) RUN	Integral Time (I)	<p><b>V/f</b> <b>CL-V/f</b> <b>OLV</b> <b>CLV</b> <b>AOLV</b> <b>OLV/PM</b> <b>AOLV/PM</b> <b>CLV/PM</b> <b>EZOLV</b></p> <p>Sets the integral time (I) that is applied to PID input.</p>	1.0 s (0.0 - 360.0 s)	730
b5-04 (01A8) RUN	Integral Limit	<p><b>V/f</b> <b>CL-V/f</b> <b>OLV</b> <b>CLV</b> <b>AOLV</b> <b>OLV/PM</b> <b>AOLV/PM</b> <b>CLV/PM</b> <b>EZOLV</b></p> <p>Sets the upper limit for I control as a percentage of <i>E1-04 [Maximum Output Frequency]</i>.</p>	100.0% (0.0 - 100.0%)	730
b5-05 (01A9) RUN	Derivative Time (D)	<p><b>V/f</b> <b>CL-V/f</b> <b>OLV</b> <b>CLV</b> <b>AOLV</b> <b>OLV/PM</b> <b>AOLV/PM</b> <b>CLV/PM</b> <b>EZOLV</b></p> <p>Sets the derivative time (D) for PID control. This parameter adjusts system responsiveness.</p>	0.00 s (0.00 - 10.00 s)	730
b5-06 (01AA) RUN	PID Output Limit	<p><b>V/f</b> <b>CL-V/f</b> <b>OLV</b> <b>CLV</b> <b>AOLV</b> <b>OLV/PM</b> <b>AOLV/PM</b> <b>CLV/PM</b> <b>EZOLV</b></p> <p>Sets the maximum possible output from the PID controller as a percentage of <i>E1-04 [Maximum Output Frequency]</i>.</p>	100.0% (0.0 - 100.0%)	731
b5-07 (01AB) RUN	PID Offset Adjustment	<p><b>V/f</b> <b>CL-V/f</b> <b>OLV</b> <b>CLV</b> <b>AOLV</b> <b>OLV/PM</b> <b>AOLV/PM</b> <b>CLV/PM</b> <b>EZOLV</b></p> <p>Sets the offset for the PID control output as a percentage of <i>E1-04 [Maximum Output Frequency]</i>.</p>	0.0% (-100.0 - +100.0%)	731
b5-08 (01AC) Expert	PID Primary Delay Time Constant	<p><b>V/f</b> <b>CL-V/f</b> <b>OLV</b> <b>CLV</b> <b>AOLV</b> <b>OLV/PM</b> <b>AOLV/PM</b> <b>CLV/PM</b> <b>EZOLV</b></p> <p>Sets the primary delay time constant for the PID control output. Usually it is not necessary to change this setting.</p>	0.00 s (0.00 - 10.00 s)	731
b5-09 (01AD)	PID Output Level Selection	<p><b>V/f</b> <b>CL-V/f</b> <b>OLV</b> <b>CLV</b> <b>AOLV</b> <b>OLV/PM</b> <b>AOLV/PM</b> <b>CLV/PM</b> <b>EZOLV</b></p> <p>Sets the polarity of the PID output.            0 : Normal Output (Direct Acting)            1 : Reverse Output (Reverse Acting)</p>	0 (0, 1)	731
b5-10 (01AE) RUN	PID Output Gain Setting	<p><b>V/f</b> <b>CL-V/f</b> <b>OLV</b> <b>CLV</b> <b>AOLV</b> <b>OLV/PM</b> <b>AOLV/PM</b> <b>CLV/PM</b> <b>EZOLV</b></p> <p>Sets the amount of gain to apply to the PID output.</p>	1.00 (0.00 - 25.00)	731
b5-11 (01AF)	PID Output Reverse Selection	<p><b>V/f</b> <b>CL-V/f</b> <b>OLV</b> <b>CLV</b> <b>AOLV</b> <b>OLV/PM</b> <b>AOLV/PM</b> <b>CLV/PM</b> <b>EZOLV</b></p> <p>Sets the function that enables and disables reverse motor rotation for negative PID control output.            0 : Lower Limit is Zero            1 : Negative Output Accepted</p>	0 (0, 1)	731

No. (Hex.)	Name	Description	Default (Range)	Ref.
b5-12 (01B0)	Feedback Loss Detection Select	<b>V/f</b> <b>CL-V/f</b> <b>OLV</b> <b>CLV</b> <b>AOLV</b> <b>OLV/PM</b> <b>AOLV/PM</b> <b>CLV/PM</b> <b>EZOLV</b> Sets the drive response to PID feedback loss. Sets drive operation after the drive detects PID feedback loss. 0 : Digital Out Only, Always Detect 1 : Alarm + Digital Out, Always Det 2 : Fault + Digital Out, Always Det 3 : Digital Out Only, @ PID Enable 4 : Alarm + Digital Out, @PID Enable 5 : Fault + Digital Out, @PID Enable	0 (0 - 5)	732
b5-13 (01B1)	PID Feedback Loss Detection Lvl	<b>V/f</b> <b>CL-V/f</b> <b>OLV</b> <b>CLV</b> <b>AOLV</b> <b>OLV/PM</b> <b>AOLV/PM</b> <b>CLV/PM</b> <b>EZOLV</b> Sets the level that triggers <i>PID Feedback Loss [FbL]</i> as a percentage of <i>E1-04 [Maximum Output Frequency]</i> .	0% (0 - 100%)	733
b5-14 (01B2)	PID Feedback Loss Detection Time	<b>V/f</b> <b>CL-V/f</b> <b>OLV</b> <b>CLV</b> <b>AOLV</b> <b>OLV/PM</b> <b>AOLV/PM</b> <b>CLV/PM</b> <b>EZOLV</b> Sets the length of time that PID Feedback must be less than <i>b5-13 [PID Feedback Loss Detection Lvl]</i> to detect <i>PID Feedback Loss [FbL]</i> .	1.0 s (0.0 - 25.5 s)	733
b5-15 (01B3)	PID Sleep Function Start Level	<b>V/f</b> <b>CL-V/f</b> <b>OLV</b> <b>CLV</b> <b>AOLV</b> <b>OLV/PM</b> <b>AOLV/PM</b> <b>CLV/PM</b> <b>EZOLV</b> Sets the output level that triggers the PID Sleep function.	Determined by A1-02 (0.0 - 590.0)	733
b5-16 (01B4)	PID Sleep Delay Time	<b>V/f</b> <b>CL-V/f</b> <b>OLV</b> <b>CLV</b> <b>AOLV</b> <b>OLV/PM</b> <b>AOLV/PM</b> <b>CLV/PM</b> <b>EZOLV</b> Sets a delay time to start or stop the PID Sleep function.	0.0 s (0.0 - 25.5 s)	733
b5-17 (01B5)	PID Accel/Decel Time	<b>V/f</b> <b>CL-V/f</b> <b>OLV</b> <b>CLV</b> <b>AOLV</b> <b>OLV/PM</b> <b>AOLV/PM</b> <b>CLV/PM</b> <b>EZOLV</b> Raises or lowers the PID setpoint using the acceleration and deceleration times set to the drive. This is a soft-starter for the PID setpoint.	0.0 s (0.0 - 6000.0 s)	733
b5-18 (01DC)	b5-19 PID Setpoint Selection	<b>V/f</b> <b>CL-V/f</b> <b>OLV</b> <b>CLV</b> <b>AOLV</b> <b>OLV/PM</b> <b>AOLV/PM</b> <b>CLV/PM</b> <b>EZOLV</b> Sets the function that enables and disables <i>b5-19 [PID Setpoint Value]</i> . 0 : Disabled 1 : Enabled	0 (0, 1)	733
b5-19 (01DD) RUN	PID Setpoint Value	<b>V/f</b> <b>CL-V/f</b> <b>OLV</b> <b>CLV</b> <b>AOLV</b> <b>OLV/PM</b> <b>AOLV/PM</b> <b>CLV/PM</b> <b>EZOLV</b> Sets the PID setpoint when <i>b5-18 = 1 [b5-19 PID Setpoint Selection = Enabled]</i> .	0.00% (0.00 - 100.00%)	734
b5-20 (01E2)	PID Unit Selection	<b>V/f</b> <b>CL-V/f</b> <b>OLV</b> <b>CLV</b> <b>AOLV</b> <b>OLV/PM</b> <b>AOLV/PM</b> <b>CLV/PM</b> <b>EZOLV</b> Sets the units to set and show <i>b5-19 [PID Setpoint Value]</i> . 0 : 0.01Hz units 1 : 0.01% units 2 : min <sup>-1</sup> 3 : User Units	1 (0 - 3)	734
b5-34 (019F) RUN	PID Output Lower Limit Level	<b>V/f</b> <b>CL-V/f</b> <b>OLV</b> <b>CLV</b> <b>AOLV</b> <b>OLV/PM</b> <b>AOLV/PM</b> <b>CLV/PM</b> <b>EZOLV</b> Sets the output lower limit for the PID control as a percentage of <i>E1-04 [Maximum Output Frequency]</i> .	0.0% (-100.0 - +100.0%)	734
b5-35 (01A0) RUN	PID Input Limit Level	<b>V/f</b> <b>CL-V/f</b> <b>OLV</b> <b>CLV</b> <b>AOLV</b> <b>OLV/PM</b> <b>AOLV/PM</b> <b>CLV/PM</b> <b>EZOLV</b> Sets the input upper limit for the PID control as a percentage of <i>E1-04 [Maximum Output Frequency]</i> .	1000.0% (0.0 - 1000.0%)	734
b5-36 (01A1)	PID High Feedback Detection Lvl	<b>V/f</b> <b>CL-V/f</b> <b>OLV</b> <b>CLV</b> <b>AOLV</b> <b>OLV/PM</b> <b>AOLV/PM</b> <b>CLV/PM</b> <b>EZOLV</b> Sets the level that triggers <i>Excessive PID Feedback [FbH]</i> as a percentage of <i>E1-04 [Maximum Output Frequency]</i> .	100% (0 - 100%)	734
b5-37 (01A2)	PID High Feedback Detection Time	<b>V/f</b> <b>CL-V/f</b> <b>OLV</b> <b>CLV</b> <b>AOLV</b> <b>OLV/PM</b> <b>AOLV/PM</b> <b>CLV/PM</b> <b>EZOLV</b> Sets the length of time that the feedback signal must be more than the level set in <i>b5-36 [PID High Feedback Detection Lvl]</i> to cause <i>Excessive PID Feedback [FbH]</i> .	1.0 s (0.0 - 25.5 s)	735
b5-38 (01FE)	PID User Unit Display Scaling	<b>V/f</b> <b>CL-V/f</b> <b>OLV</b> <b>CLV</b> <b>AOLV</b> <b>OLV/PM</b> <b>AOLV/PM</b> <b>CLV/PM</b> <b>EZOLV</b> Sets the display for <i>U5-01, U5-04</i> when the drive operates at the maximum output frequency.	Determined by b5-20 (1 - 60000)	735

No. (Hex.)	Name	Description	Default (Range)	Ref.
b5-39 (01FF)	PID User Unit Display Digits	<b>V/f</b> <b>CL-V/f</b> <b>OLV</b> <b>CLV</b> <b>AOLV</b> <b>OLV/PM</b> <b>AOLV/PM</b> <b>CLV/PM</b> <b>EZOLV</b> Sets the number of digits to set and show the PID setpoint. 0 : No Decimal Places (XXXXX) 1 : One Decimal Places (XXXX.X) 2 : Two Decimal Places (XXX.XX) 3 : Three Decimal Places (XX.XXX)	Determined by b5-20 (0 - 3)	735
b5-40 (017F)	Frequency Reference Monitor @PID	<b>V/f</b> <b>CL-V/f</b> <b>OLV</b> <b>CLV</b> <b>AOLV</b> <b>OLV/PM</b> <b>AOLV/PM</b> <b>CLV/PM</b> <b>EZOLV</b> Sets the contents for monitor U1-01 [Frequency Reference] in PID control. 0 : U1-01 Includes PID Output 1 : U1-01 Excludes PID Output	0 (0, 1)	735
b5-47 (017D)	PID Trim Mode Output Reverse Sel	<b>V/f</b> <b>CL-V/f</b> <b>OLV</b> <b>CLV</b> <b>AOLV</b> <b>OLV/PM</b> <b>AOLV/PM</b> <b>CLV/PM</b> <b>EZOLV</b> Sets reverse motor rotation when the PID control output is negative. 0 : Lower Limit is Zero 1 : Negative Output Accepted	1 (0, 1)	735
b5-53 (0B8F) RUN	PID Integrator Ramp Limit	<b>V/f</b> <b>CL-V/f</b> <b>OLV</b> <b>CLV</b> <b>AOLV</b> <b>OLV/PM</b> <b>AOLV/PM</b> <b>CLV/PM</b> <b>EZOLV</b> Sets the responsiveness of PID control when the PID feedback changes quickly.	0.0 Hz (0.0 - 10.0 Hz)	736
b5-54 (0BB7)	PID Softstarter Cancel Selection	<b>V/f</b> <b>CL-V/f</b> <b>OLV</b> <b>CLV</b> <b>AOLV</b> <b>OLV/PM</b> <b>AOLV/PM</b> <b>CLV/PM</b> <b>EZOLV</b> Sets how the soft-starter responds to PID input/output. 0 : Disabled 1 : Enabled	0 (0, 1)	736
b5-55 (0BE1)	PID Feedback Monitor Selection	<b>V/f</b> <b>CL-V/f</b> <b>OLV</b> <b>CLV</b> <b>AOLV</b> <b>OLV/PM</b> <b>AOLV/PM</b> <b>CLV/PM</b> <b>EZOLV</b> Sets the monitor for PID Feedback (Ux-xx).	000 (000 - 999)	736
b5-56 (0BE2)	PID Feedback Monitor Gain	<b>V/f</b> <b>CL-V/f</b> <b>OLV</b> <b>CLV</b> <b>AOLV</b> <b>OLV/PM</b> <b>AOLV/PM</b> <b>CLV/PM</b> <b>EZOLV</b> Sets the gain for the monitor specified in b5-55 [PID Feedback Monitor Selection].	1.00 (0.00 - 10.00)	736
b5-57 (11DD)	PID Feedback Monitor Bias	<b>V/f</b> <b>CL-V/f</b> <b>OLV</b> <b>CLV</b> <b>AOLV</b> <b>OLV/PM</b> <b>AOLV/PM</b> <b>CLV/PM</b> <b>EZOLV</b> Sets the bias for the monitor specified in b5-55 [PID Feedback Monitor Selection].	0.00 (-10.00 - +10.00)	737
b5-58 to b5-60 (1182 - 1184) RUN	PID Setpoints 2 to 4	<b>V/f</b> <b>CL-V/f</b> <b>OLV</b> <b>CLV</b> <b>AOLV</b> <b>OLV/PM</b> <b>AOLV/PM</b> <b>CLV/PM</b> <b>EZOLV</b> Sets the PID setpoint when H1-xx = 3E or 3F [MFDI Function Select = PID Setpoint Selection 1/2]. This value is a percentage where E1-04 [Maximum Output Frequency] setting = a setting value of 100%.	0.00% (0.00 - 100.00%)	737
b5-61 (119A)	PID Trim Mode Lower Limit Sel	<b>V/f</b> <b>CL-V/f</b> <b>OLV</b> <b>CLV</b> <b>AOLV</b> <b>OLV/PM</b> <b>AOLV/PM</b> <b>CLV/PM</b> <b>EZOLV</b> Sets the function that adjusts the PID output in relation to the frequency reference. 0 : Disabled 1 : Enabled	0 (0, 1)	737
b5-62 (119B)	PID Trim Mode Lower Limit Value	<b>V/f</b> <b>CL-V/f</b> <b>OLV</b> <b>CLV</b> <b>AOLV</b> <b>OLV/PM</b> <b>AOLV/PM</b> <b>CLV/PM</b> <b>EZOLV</b> Sets the lower limit of the PID frequency reference trim as a percentage where E1-04 [Maximum Output Frequency] setting = a setting value of 100%.	0.00% (0.00 - 100.00%)	737
b5-63 (119C)	PID Differential FB Monitor Sel	<b>V/f</b> <b>CL-V/f</b> <b>OLV</b> <b>CLV</b> <b>AOLV</b> <b>OLV/PM</b> <b>AOLV/PM</b> <b>CLV/PM</b> <b>EZOLV</b> Sets the monitor for PID Differential Feedback (Ux-xx).	000 (000 - 999)	738
b5-64 (119D)	PID Differential FB Monitor Gain	<b>V/f</b> <b>CL-V/f</b> <b>OLV</b> <b>CLV</b> <b>AOLV</b> <b>OLV/PM</b> <b>AOLV/PM</b> <b>CLV/PM</b> <b>EZOLV</b> Sets the gain for the monitor specified in b5-63 [PID Differential FB Monitor Sel].	1.00 (0.00 - 10.00)	738
b5-65 (119F)	PID Differential FB Monitor Bias	<b>V/f</b> <b>CL-V/f</b> <b>OLV</b> <b>CLV</b> <b>AOLV</b> <b>OLV/PM</b> <b>AOLV/PM</b> <b>CLV/PM</b> <b>EZOLV</b> Sets the bias for the monitor specified in b5-63 [PID Differential FB Monitor Sel].	0.00 (-10.00 - +10.00)	738
b5-66 (11DE)	PID Feedback Monitor Level	<b>V/f</b> <b>CL-V/f</b> <b>OLV</b> <b>CLV</b> <b>AOLV</b> <b>OLV/PM</b> <b>AOLV/PM</b> <b>CLV/PM</b> <b>EZOLV</b> Sets the signal level for the monitor specified in b5-55 [PID Feedback Monitor Selection]. 0 : Absolute 1 : Bi-directional (+/-)	0 (0, 1)	738

No. (Hex.)	Name	Description	Default (Range)	Ref.
b5-67 (11DF)	PID Differential FB Monitor Lvl	<b>V/f</b> <b>CL-V/f</b> <b>OLV</b> <b>CLV</b> <b>AOLV</b> <b>OLV/PM</b> <b>AOLV/PM</b> <b>CLV/PM</b> <b>EZOLV</b> Sets the signal level for the monitor specified in b5-63 [PID Differential FB Monitor Sel]. 0 : Absolute 1 : Bi-directional (+/-)	0 (0, 1)	738
b5-89 (0B89) RUN	Sleep Method Selection	<b>V/f</b> <b>CL-V/f</b> <b>OLV</b> <b>CLV</b> <b>AOLV</b> <b>OLV/PM</b> <b>AOLV/PM</b> <b>CLV/PM</b> <b>EZOLV</b> Sets sleep and wake up operation when using PID. 0 : Standard 1 : EZ Sleep/Wake-up	0 (0, 1)	738
b5-90 (0B90)	EZ Sleep Unit	<b>V/f</b> <b>CL-V/f</b> <b>OLV</b> <b>CLV</b> <b>AOLV</b> <b>OLV/PM</b> <b>AOLV/PM</b> <b>CLV/PM</b> <b>EZOLV</b> Sets the measurement units for b5-91 [EZ Sleep Minimum Speed] and b5-92 [EZ Sleep Level]. 0 : 0.1Hz units 1 : rev/min	0 (0, 1)	739
b5-91 (0B91) RUN	EZ Sleep Minimum Speed	<b>V/f</b> <b>CL-V/f</b> <b>OLV</b> <b>CLV</b> <b>AOLV</b> <b>OLV/PM</b> <b>AOLV/PM</b> <b>CLV/PM</b> <b>EZOLV</b> Sets the minimum speed for the EZ Sleep/Wakeup function. This parameter uses the largest value from b5-91, b5-34 [PID Output Lower Limit Level], and d2-02 [Frequency Reference Lower Limit].	0.0 Hz or 0 min <sup>-1</sup> (r/min) (0.0 to 590.0 Hz or 0 to 35400 min <sup>-1</sup> (r/min))	739
b5-92 (0B92) RUN	EZ Sleep Level	<b>V/f</b> <b>CL-V/f</b> <b>OLV</b> <b>CLV</b> <b>AOLV</b> <b>OLV/PM</b> <b>AOLV/PM</b> <b>CLV/PM</b> <b>EZOLV</b> Sets the value that the output frequency or motor speed must be less than for longer than b5-93 [EZ Sleep Time] to enter Sleep Mode.	0.0 Hz or 0 min <sup>-1</sup> (r/min) (0.0 to 590.0 Hz or 0 to 35400 min <sup>-1</sup> (r/min))	739
b5-93 (0B93) RUN	EZ Sleep Time	<b>V/f</b> <b>CL-V/f</b> <b>OLV</b> <b>CLV</b> <b>AOLV</b> <b>OLV/PM</b> <b>AOLV/PM</b> <b>CLV/PM</b> <b>EZOLV</b> Sets the length of time that the output frequency or motor speed must be less than b5-92 [EZ Sleep Level] to enter Sleep Mode.	5.0 s (0.0 - 1000.0 s)	739
b5-94 (0B94) RUN	EZ Sleep Wake-up Level	<b>V/f</b> <b>CL-V/f</b> <b>OLV</b> <b>CLV</b> <b>AOLV</b> <b>OLV/PM</b> <b>AOLV/PM</b> <b>CLV/PM</b> <b>EZOLV</b> Sets the level at which the drive resumes operation when exiting Sleep Mode.	0.00% (0.00 - 600.00%)	739
b5-95 (0B95)	EZ Sleep Wake-up Mode	<b>V/f</b> <b>CL-V/f</b> <b>OLV</b> <b>CLV</b> <b>AOLV</b> <b>OLV/PM</b> <b>AOLV/PM</b> <b>CLV/PM</b> <b>EZOLV</b> Sets the wake-up mode to use when exiting Sleep Mode. 0 : Absolute 1 : Setpoint Delta	0 (0, 1)	740
b5-96 (0B96)	EZ Sleep Wake-up Time	<b>V/f</b> <b>CL-V/f</b> <b>OLV</b> <b>CLV</b> <b>AOLV</b> <b>OLV/PM</b> <b>AOLV/PM</b> <b>CLV/PM</b> <b>EZOLV</b> Sets the EZ Wake-up time.	1.0 s (0.0 - 1000.0 s)	740

◆ b6: Dwell Function

No. (Hex.)	Name	Description	Default (Range)	Ref.
b6-01 (01B6)	Dwell Reference at Start	<b>V/f</b> <b>CL-V/f</b> <b>OLV</b> <b>CLV</b> <b>AOLV</b> <b>OLV/PM</b> <b>AOLV/PM</b> <b>CLV/PM</b> <b>EZOLV</b> Sets the output frequency that the drive will hold momentarily when the motor starts.	0.0 (Determined by A1-02)	740
b6-02 (01B7)	Dwell Time at Start	<b>V/f</b> <b>CL-V/f</b> <b>OLV</b> <b>CLV</b> <b>AOLV</b> <b>OLV/PM</b> <b>AOLV/PM</b> <b>CLV/PM</b> <b>EZOLV</b> Sets the length of time that the drive will hold the output frequency when the motor starts.	0.0 s (0.0 - 10.0 s)	741
b6-03 (01B8)	Dwell Reference at Stop	<b>V/f</b> <b>CL-V/f</b> <b>OLV</b> <b>CLV</b> <b>AOLV</b> <b>OLV/PM</b> <b>AOLV/PM</b> <b>CLV/PM</b> <b>EZOLV</b> Sets the output frequency that the drive will hold momentarily when ramping to stop the motor.	0.0 (Determined by A1-02)	741
b6-04 (01B9)	Dwell Time at Stop	<b>V/f</b> <b>CL-V/f</b> <b>OLV</b> <b>CLV</b> <b>AOLV</b> <b>OLV/PM</b> <b>AOLV/PM</b> <b>CLV/PM</b> <b>EZOLV</b> Sets the length of time for the drive to hold the output frequency when ramping to stop the motor.	0.0 s (0.0 - 10.0 s)	741

## ◆ b7: Droop Control

No. (Hex.)	Name	Description	Default (Range)	Ref.
b7-01 (01CA) RUN	Droop Control Gain	<span>V/f</span> <span>CL-V/f</span> <span>OLV</span> <span>CLV</span> <span>AOLV</span> <span>OLV/PM</span> <span>AOLV/PM</span> <span>CLV/PM</span> <span>EZOLV</span> Sets the amount of deceleration when the torque reference is at 100% of Maximum Output Frequency.	0.0% (0.0 - 100.0%)	741
b7-02 (01CB) RUN	Droop Control Delay Time	<span>V/f</span> <span>CL-V/f</span> <span>OLV</span> <span>CLV</span> <span>AOLV</span> <span>OLV/PM</span> <span>AOLV/PM</span> <span>CLV/PM</span> <span>EZOLV</span> Sets the responsiveness of Droop control. Decrease this setting when drive response is slow. Increase this setting when hunting or oscillation occur.	0.05 s (0.03 - 2.00 s)	742
b7-03 (017E)	Droop Control Limit Selection	<span>V/f</span> <span>CL-V/f</span> <span>OLV</span> <span>CLV</span> <span>AOLV</span> <span>OLV/PM</span> <span>AOLV/PM</span> <span>CLV/PM</span> <span>EZOLV</span> Sets the Droop control limit function. 0 : Disabled 1 : Enabled	1 (0, 1)	742

## ◆ b8: Energy Saving

No. (Hex.)	Name	Description	Default (Range)	Ref.
b8-01 (01CC)	Energy Saving Control Selection	<span>V/f</span> <span>CL-V/f</span> <span>OLV</span> <span>CLV</span> <span>AOLV</span> <span>OLV/PM</span> <span>AOLV/PM</span> <span>CLV/PM</span> <span>EZOLV</span> Sets the Energy-saving control function. 0 : Disabled 1 : Enabled 2 : Automatic Optimization	0 (Determined by A1-02)	742
b8-02 (01CD) RUN Expert	Energy Saving Gain	<span>V/f</span> <span>CL-V/f</span> <span>OLV</span> <span>CLV</span> <span>AOLV</span> <span>OLV/PM</span> <span>AOLV/PM</span> <span>CLV/PM</span> <span>EZOLV</span> Sets the gain for Energy-saving control.	Determined by A1-02 (0.0 - 10.0)	743
b8-03 (01CE) RUN Expert	Energy Saving Filter Time	<span>V/f</span> <span>CL-V/f</span> <span>OLV</span> <span>CLV</span> <span>AOLV</span> <span>OLV/PM</span> <span>AOLV/PM</span> <span>CLV/PM</span> <span>EZOLV</span> Sets the responsiveness for Energy-saving control.	Determined by A1-02, C6-01, and o2-04 (0.00 - 10.00 s)	743
b8-04 (01CF) Expert	Energy Saving Coefficient Value	<span>V/f</span> <span>CL-V/f</span> <span>OLV</span> <span>CLV</span> <span>AOLV</span> <span>OLV/PM</span> <span>AOLV/PM</span> <span>CLV/PM</span> <span>EZOLV</span> Sets the Energy-saving control coefficient to maintain maximum motor efficiency. The default setting is for Yaskawa motors.	Determined by C6-01, E2-11, o2-04 (0.00 - 655.00)	743
b8-05 (01D0) Expert	Power Detection Filter Time	<span>V/f</span> <span>CL-V/f</span> <span>OLV</span> <span>CLV</span> <span>AOLV</span> <span>OLV/PM</span> <span>AOLV/PM</span> <span>CLV/PM</span> <span>EZOLV</span> Sets the time constant to measure output power.	20 ms (0 - 2000 ms)	743
b8-06 (01D1) Expert	Search Operation Voltage Limit	<span>V/f</span> <span>CL-V/f</span> <span>OLV</span> <span>CLV</span> <span>AOLV</span> <span>OLV/PM</span> <span>AOLV/PM</span> <span>CLV/PM</span> <span>EZOLV</span> Sets the voltage limit for Search Operation as a percentage where motor rated voltage is a setting value of 100%.	0% (0 - 100%)	743
b8-16 (01F8) Expert	PM E-Save Coefficient Ki	<span>V/f</span> <span>CL-V/f</span> <span>OLV</span> <span>CLV</span> <span>AOLV</span> <span>OLV/PM</span> <span>AOLV/PM</span> <span>CLV/PM</span> <span>EZOLV</span> Sets torque linearity. This parameter uses the Ki value from the motor nameplate. Usually it is not necessary to change this setting.	1.00 (0.00 - 3.00)	744
b8-17 (01F9) Expert	PM E-Save Coefficient Kt	<span>V/f</span> <span>CL-V/f</span> <span>OLV</span> <span>CLV</span> <span>AOLV</span> <span>OLV/PM</span> <span>AOLV/PM</span> <span>CLV/PM</span> <span>EZOLV</span> Sets torque linearity. This parameter uses the Kt value from the motor nameplate. Usually it is not necessary to change this setting.	1.00 (0.00 - 3.00)	744
b8-18 (01FA) Expert	E-Save d-axis Current FilterTime	<span>V/f</span> <span>CL-V/f</span> <span>OLV</span> <span>CLV</span> <span>AOLV</span> <span>OLV/PM</span> <span>AOLV/PM</span> <span>CLV/PM</span> <span>EZOLV</span> Sets the d-axis current reference filter time constant.	0.100 s (0.000 - 5.000 s)	744
b8-19 (0B40) Expert	E-Save Search Injection Freq	<span>V/f</span> <span>CL-V/f</span> <span>OLV</span> <span>CLV</span> <span>AOLV</span> <span>OLV/PM</span> <span>AOLV/PM</span> <span>CLV/PM</span> <span>EZOLV</span> Sets the frequency of Energy-saving control search operations. Usually it is not necessary to change this setting.	Determined by A1-02 (20 - 300 Hz)	744

## 10.5 b: Application

No. (Hex.)	Name	Description	Default (Range)	Ref.
b8-20 (0B41) Expert	E-Save Search Width	<input type="checkbox"/> V/f <input type="checkbox"/> CL-V/f <input type="checkbox"/> OLV <input type="checkbox"/> CLV <input type="checkbox"/> AOLV <input type="checkbox"/> OLV/PM <input type="checkbox"/> AOLV/PM <input checked="" type="checkbox"/> CLV/PM <input type="checkbox"/> EZOLV Sets the amplitude of Energy-saving control search operations.	1.0 degrees (0.1 - 5.0 degrees)	744
b8-21 (0B42) Expert	PM E-Save Search Gain	<input type="checkbox"/> V/f <input type="checkbox"/> CL-V/f <input type="checkbox"/> OLV <input type="checkbox"/> CLV <input type="checkbox"/> AOLV <input type="checkbox"/> OLV/PM <input type="checkbox"/> AOLV/PM <input checked="" type="checkbox"/> CLV/PM <input type="checkbox"/> EZOLV Sets the gain of Energy-saving control search operations.	0.3Hz (0.1 - 20.0 Hz)	745
b8-22 (0B43) Expert	PM E-Save Search LPF Cutoff Freq	<input type="checkbox"/> V/f <input type="checkbox"/> CL-V/f <input type="checkbox"/> OLV <input type="checkbox"/> CLV <input type="checkbox"/> AOLV <input type="checkbox"/> OLV/PM <input type="checkbox"/> AOLV/PM <input checked="" type="checkbox"/> CLV/PM <input type="checkbox"/> EZOLV Sets the frequency of the filter used to extract the high-efficiency phase from search operations. Usually it is not necessary to change this setting.	10.0 Hz (1.0 - 30.0 Hz)	745
b8-23 (0B44) Expert	PM E-Save Search Limit	<input type="checkbox"/> V/f <input type="checkbox"/> CL-V/f <input type="checkbox"/> OLV <input type="checkbox"/> CLV <input type="checkbox"/> AOLV <input type="checkbox"/> OLV/PM <input type="checkbox"/> AOLV/PM <input checked="" type="checkbox"/> CLV/PM <input type="checkbox"/> EZOLV Sets the search operations output limit. Usually it is not necessary to change this setting.	15.0 degrees (0.0 - 30.0 degrees)	745
b8-24 (0B45) Expert	PM E-Save High Freq ACR Gain	<input type="checkbox"/> V/f <input type="checkbox"/> CL-V/f <input type="checkbox"/> OLV <input type="checkbox"/> CLV <input type="checkbox"/> AOLV <input type="checkbox"/> OLV/PM <input type="checkbox"/> AOLV/PM <input checked="" type="checkbox"/> CLV/PM <input type="checkbox"/> EZOLV Sets the gain for high-frequency current control.	200.0 Hz (100.0 - 1000.0 Hz)	745
b8-25 (0B46) Expert	PM E-Save Search Start Level	<input type="checkbox"/> V/f <input type="checkbox"/> CL-V/f <input type="checkbox"/> OLV <input type="checkbox"/> CLV <input type="checkbox"/> AOLV <input type="checkbox"/> OLV/PM <input type="checkbox"/> AOLV/PM <input checked="" type="checkbox"/> CLV/PM <input type="checkbox"/> EZOLV Sets the start level for search operations.	10.0% (0.0 - 100.0%)	745
b8-26 (0B47) Expert	PM E-Save Power Setpoint	<input type="checkbox"/> V/f <input type="checkbox"/> CL-V/f <input type="checkbox"/> OLV <input type="checkbox"/> CLV <input type="checkbox"/> AOLV <input type="checkbox"/> OLV/PM <input type="checkbox"/> AOLV/PM <input checked="" type="checkbox"/> CLV/PM <input type="checkbox"/> EZOLV Sets a value to increase torque accuracy.	0.0% (-10.0 - +10.0%)	745
b8-28 (0B8B) Expert	Over Excitation Action Selection	<input type="checkbox"/> V/f <input type="checkbox"/> CL-V/f <input type="checkbox"/> OLV <input type="checkbox"/> CLV <input type="checkbox"/> AOLV <input type="checkbox"/> OLV/PM <input type="checkbox"/> AOLV/PM <input type="checkbox"/> CLV/PM <input checked="" type="checkbox"/> EZOLV Sets the function for excitation operation. 0 : Disabled 1 : Enabled	0 (0, 1)	746
b8-29 (0B8C)	Energy Saving Priority Selection	<input type="checkbox"/> V/f <input type="checkbox"/> CL-V/f <input type="checkbox"/> OLV <input type="checkbox"/> CLV <input type="checkbox"/> AOLV <input type="checkbox"/> OLV/PM <input type="checkbox"/> AOLV/PM <input type="checkbox"/> CLV/PM <input checked="" type="checkbox"/> EZOLV Sets the priority of drive response between changes to the load or Energy-saving control. 0 : Priority: Drive Response 1 : Priority: Energy Savings	0 (0, 1)	746
b8-50 (0B0D)	Standby Mode Selection	<input type="checkbox"/> V/f <input type="checkbox"/> CL-V/f <input type="checkbox"/> OLV <input checked="" type="checkbox"/> CLV <input type="checkbox"/> AOLV <input type="checkbox"/> OLV/PM <input type="checkbox"/> AOLV/PM <input type="checkbox"/> CLV/PM <input type="checkbox"/> EZOLV Sets the Standby Mode function. 0 : Disabled 1 : Enabled	0 (0, 1)	746
b8-51 (0B01)	Standby Mode Wait Time	<input type="checkbox"/> V/f <input type="checkbox"/> CL-V/f <input type="checkbox"/> OLV <input type="checkbox"/> CLV <input type="checkbox"/> AOLV <input type="checkbox"/> OLV/PM <input type="checkbox"/> AOLV/PM <input type="checkbox"/> CLV/PM <input checked="" type="checkbox"/> EZOLV Sets the delay time before turning off the electromagnetic contactor after the drive stops.	600 s (0 - 6000 s)	747

## ◆ b9: Zero Servo

No. (Hex.)	Name	Description	Default (Range)	Ref.
b9-01 (01DA)	Zero Servo Gain	<input type="checkbox"/> V/f <input type="checkbox"/> CL-V/f <input type="checkbox"/> OLV <input checked="" type="checkbox"/> CLV <input type="checkbox"/> AOLV <input type="checkbox"/> OLV/PM <input type="checkbox"/> AOLV/PM <input type="checkbox"/> CLV/PM <input type="checkbox"/> EZOLV Sets the responsiveness for the Zero Servo function.	5 (0 - 100)	747
b9-02 (01DB)	Zero Servo Completion Window	<input type="checkbox"/> V/f <input type="checkbox"/> CL-V/f <input type="checkbox"/> OLV <input checked="" type="checkbox"/> CLV <input type="checkbox"/> AOLV <input type="checkbox"/> OLV/PM <input type="checkbox"/> AOLV/PM <input type="checkbox"/> CLV/PM <input type="checkbox"/> EZOLV Sets the range to trigger an output terminal set for "Zero Servo Complete" during Zero Servo operation. Be sure to set the deviation from the Zero Servo start position.	10 (0 - 16383)	748



## 10.6 C: Tuning

### ◆ C1: Accel & Decel Time

No. (Hex.)	Name	Description	Default (Range)	Ref.
C1-01 (0200) RUN	Acceleration Time 1	<b>V/f</b> <b>CL-V/f</b> <b>OLV</b> <b>CLV</b> <b>AOLV</b> <b>OLV/PM</b> <b>AOLV/PM</b> <b>CLV/PM</b> <b>EZOLV</b> Sets the length of time to accelerate from zero to maximum output frequency.	10.0 s (0.0 - 6000.0 s)	751
C1-02 (0201) RUN	Deceleration Time 1	<b>V/f</b> <b>CL-V/f</b> <b>OLV</b> <b>CLV</b> <b>AOLV</b> <b>OLV/PM</b> <b>AOLV/PM</b> <b>CLV/PM</b> <b>EZOLV</b> Sets the length of time to decelerate from maximum output frequency to zero.	10.0 s (0.0 - 6000.0 s)	751
C1-03 (0202) RUN	Acceleration Time 2	<b>V/f</b> <b>CL-V/f</b> <b>OLV</b> <b>CLV</b> <b>AOLV</b> <b>OLV/PM</b> <b>AOLV/PM</b> <b>CLV/PM</b> <b>EZOLV</b> Sets the length of time to accelerate from zero to maximum output frequency.	10.0 s (0.0 - 6000.0 s)	751
C1-04 (0203) RUN	Deceleration Time 2	<b>V/f</b> <b>CL-V/f</b> <b>OLV</b> <b>CLV</b> <b>AOLV</b> <b>OLV/PM</b> <b>AOLV/PM</b> <b>CLV/PM</b> <b>EZOLV</b> Sets the length of time to decelerate from maximum output frequency to zero.	10.0 s (0.0 - 6000.0 s)	751
C1-05 (0204) RUN	Acceleration Time 3	<b>V/f</b> <b>CL-V/f</b> <b>OLV</b> <b>CLV</b> <b>AOLV</b> <b>OLV/PM</b> <b>AOLV/PM</b> <b>CLV/PM</b> <b>EZOLV</b> Sets the length of time to accelerate from zero to maximum output frequency.	10.0 s (0.0 - 6000.0 s)	751
C1-06 (0205) RUN	Deceleration Time 3	<b>V/f</b> <b>CL-V/f</b> <b>OLV</b> <b>CLV</b> <b>AOLV</b> <b>OLV/PM</b> <b>AOLV/PM</b> <b>CLV/PM</b> <b>EZOLV</b> Sets the length of time to decelerate from maximum output frequency to zero.	10.0 s (0.0 - 6000.0 s)	751
C1-07 (0206) RUN	Acceleration Time 4	<b>V/f</b> <b>CL-V/f</b> <b>OLV</b> <b>CLV</b> <b>AOLV</b> <b>OLV/PM</b> <b>AOLV/PM</b> <b>CLV/PM</b> <b>EZOLV</b> Sets the length of time to accelerate from zero to maximum output frequency.	10.0 s (0.0 - 6000.0 s)	752
C1-08 (0207) RUN	Deceleration Time 4	<b>V/f</b> <b>CL-V/f</b> <b>OLV</b> <b>CLV</b> <b>AOLV</b> <b>OLV/PM</b> <b>AOLV/PM</b> <b>CLV/PM</b> <b>EZOLV</b> Sets the length of time to decelerate from maximum output frequency to zero.	10.0 s (0.0 - 6000.0 s)	752
C1-09 (0208)	Fast Stop Time	<b>V/f</b> <b>CL-V/f</b> <b>OLV</b> <b>CLV</b> <b>AOLV</b> <b>OLV/PM</b> <b>AOLV/PM</b> <b>CLV/PM</b> <b>EZOLV</b> Sets the length of time that the drive will decelerate to zero for a Fast Stop. <b>Note:</b> • Decelerating too quickly can cause an <i>ov</i> [Overvoltage] fault that shuts off the drive while the motor to coasts to a stop. Set a Fast Stop time in <i>C1-09</i> that prevents motor coasting and makes sure that the motor stops quickly and safely. • When <i>L2-29</i> = 0 [Kinetic Energy Backup Method = Single Drive KEB Ride-Thru 1] and you do KEB Auto-Tuning, the drive will automatically set <i>C1-09</i> . If you must not change the Fast Stop time, do not do KEB Auto-Tuning.	10.0 s (0.0 - 6000.0 s)	752
C1-10 (0209)	Accel/Decel Time Setting Units	<b>V/f</b> <b>CL-V/f</b> <b>OLV</b> <b>CLV</b> <b>AOLV</b> <b>OLV/PM</b> <b>AOLV/PM</b> <b>CLV/PM</b> <b>EZOLV</b> Sets the setting units for <i>C1-01</i> to <i>C1-08</i> [Accel/Decel Times 1 to 4], <i>C1-09</i> [Fast Stop Time], <i>L2-06</i> [Kinetic Energy Backup Decel Time], and <i>L2-07</i> [Kinetic Energy Backup Accel Time]. 0 : 0.01 s (0.00 to 600.00 s) 1 : 0.1 s (0.0 to 6000.0 s)	1 (0, 1)	752
C1-11 (020A)	Accel/Decel Time Switchover Freq	<b>V/f</b> <b>CL-V/f</b> <b>OLV</b> <b>CLV</b> <b>AOLV</b> <b>OLV/PM</b> <b>AOLV/PM</b> <b>CLV/PM</b> <b>EZOLV</b> Sets the frequency at which the drive will automatically change acceleration and deceleration times.	Determined by A1-02 (0.0 - 590.0 Hz)	753
C1-14 (0264)	Accel/Decel Rate Frequency	<b>V/f</b> <b>CL-V/f</b> <b>OLV</b> <b>CLV</b> <b>AOLV</b> <b>OLV/PM</b> <b>AOLV/PM</b> <b>CLV/PM</b> <b>EZOLV</b> Sets the base frequency used to calculate acceleration and deceleration rates.	0.0 Hz (0.0 - 590.0 Hz)	753

## ◆ C2: S-Curve Characteristics

No. (Hex.)	Name	Description	Default (Range)	Ref.
C2-01 (020B)	S-Curve Time @ Start of Accel	<input type="checkbox"/> V/f <input type="checkbox"/> CL-V/f <input type="checkbox"/> OLV <input type="checkbox"/> CLV <input type="checkbox"/> AOLV <input type="checkbox"/> OLV/PM <input type="checkbox"/> AOLV/PM <input type="checkbox"/> CLV/PM <input type="checkbox"/> EZOLV Sets the S-curve acceleration time at start.	Determined by A1-02 (0.00 - 10.00 s)	755
C2-02 (020C)	S-Curve Time @ End of Accel	<input type="checkbox"/> V/f <input type="checkbox"/> CL-V/f <input type="checkbox"/> OLV <input type="checkbox"/> CLV <input type="checkbox"/> AOLV <input type="checkbox"/> OLV/PM <input type="checkbox"/> AOLV/PM <input type="checkbox"/> CLV/PM <input type="checkbox"/> EZOLV Sets the S-curve acceleration time at completion.	0.20 s (0.00 - 10.00 s)	755
C2-03 (020D)	S-Curve Time @ Start of Decel	<input type="checkbox"/> V/f <input type="checkbox"/> CL-V/f <input type="checkbox"/> OLV <input type="checkbox"/> CLV <input type="checkbox"/> AOLV <input type="checkbox"/> OLV/PM <input type="checkbox"/> AOLV/PM <input type="checkbox"/> CLV/PM <input type="checkbox"/> EZOLV Sets the S-curve deceleration time at start.	0.20 s (0.00 - 10.00 s)	755
C2-04 (020E)	S-Curve Time @ End of Decel	<input type="checkbox"/> V/f <input type="checkbox"/> CL-V/f <input type="checkbox"/> OLV <input type="checkbox"/> CLV <input type="checkbox"/> AOLV <input type="checkbox"/> OLV/PM <input type="checkbox"/> AOLV/PM <input type="checkbox"/> CLV/PM <input type="checkbox"/> EZOLV Sets the S-curve deceleration time at completion.	0.00 s (0.00 - 10.00 s)	755

## ◆ C3: Slip Compensation

No. (Hex.)	Name	Description	Default (Range)	Ref.
C3-01 (020F) RUN	Slip Compensation Gain	<input type="checkbox"/> V/f <input type="checkbox"/> CL-V/f <input type="checkbox"/> OLV <input type="checkbox"/> CLV <input type="checkbox"/> AOLV <input type="checkbox"/> OLV/PM <input type="checkbox"/> AOLV/PM <input type="checkbox"/> CLV/PM <input type="checkbox"/> EZOLV Sets the gain for the slip compensation function. Usually it is not necessary to change this setting. <b>Note:</b> Correctly set these parameters before changing the slip compensation gain: • E2-01 [Motor Rated Current (FLA)] • E2-02 [Motor Rated Slip] (Set during Auto-Tuning when A1-02 = 2 [Control Method Selection = Open Loop Vector]) • E2-03 [Motor No-Load Current]	Determined by A1-02 (0.0 - 2.5)	755
C3-02 (0210) RUN	Slip Compensation Delay Time	<input type="checkbox"/> V/f <input type="checkbox"/> CL-V/f <input type="checkbox"/> OLV <input type="checkbox"/> CLV <input type="checkbox"/> AOLV <input type="checkbox"/> OLV/PM <input type="checkbox"/> AOLV/PM <input type="checkbox"/> CLV/PM <input type="checkbox"/> EZOLV Sets the slip compensation delay time when speed is unstable or when the slip compensation response is too slow. Usually it is not necessary to change this setting.	Determined by A1-02 (0 - 10000 ms)	756
C3-03 (0211)	Slip Compensation Limit	<input type="checkbox"/> V/f <input type="checkbox"/> CL-V/f <input type="checkbox"/> OLV <input type="checkbox"/> CLV <input type="checkbox"/> AOLV <input type="checkbox"/> OLV/PM <input type="checkbox"/> AOLV/PM <input type="checkbox"/> CLV/PM <input type="checkbox"/> EZOLV Sets the upper limit for the slip compensation function as a percentage of the motor rated slip.	200% (0 - 250%)	756
C3-04 (0212)	Slip Compensation at Regen	<input type="checkbox"/> V/f <input type="checkbox"/> CL-V/f <input type="checkbox"/> OLV <input type="checkbox"/> CLV <input type="checkbox"/> AOLV <input type="checkbox"/> OLV/PM <input type="checkbox"/> AOLV/PM <input type="checkbox"/> CLV/PM <input type="checkbox"/> EZOLV Sets the slip compensation function during regenerative operation. 0 : Disabled 1 : Enabled Above 6Hz 2 : Enabled Above C3-15	0 (0 - 2)	756
C3-05 (0213)	Output Voltage Limit Selection	<input type="checkbox"/> V/f <input type="checkbox"/> CL-V/f <input type="checkbox"/> OLV <input type="checkbox"/> CLV <input type="checkbox"/> AOLV <input type="checkbox"/> OLV/PM <input type="checkbox"/> AOLV/PM <input type="checkbox"/> CLV/PM <input type="checkbox"/> EZOLV Sets the automatic reduction of motor magnetic flux when the output voltage is saturated. 0 : Disabled 1 : Enabled	0 (0, 1)	757
C3-16 (0261) Expert	Vout Modulation Limit Start Lvl	<input type="checkbox"/> V/f <input type="checkbox"/> CL-V/f <input type="checkbox"/> OLV <input type="checkbox"/> CLV <input type="checkbox"/> AOLV <input type="checkbox"/> OLV/PM <input type="checkbox"/> AOLV/PM <input type="checkbox"/> CLV/PM <input type="checkbox"/> EZOLV Sets the modulation factor that starts the output voltage limit operation when C3-05 = 1 [Output Voltage Limit Selection = Enabled].	90.0% (70.0 - 90.0%)	757
C3-17 (0262) Expert	Vout Modulation Limit Max Level	<input type="checkbox"/> V/f <input type="checkbox"/> CL-V/f <input type="checkbox"/> OLV <input type="checkbox"/> CLV <input type="checkbox"/> AOLV <input type="checkbox"/> OLV/PM <input type="checkbox"/> AOLV/PM <input type="checkbox"/> CLV/PM <input type="checkbox"/> EZOLV Sets the modulation factor used with C3-18 [Output Voltage Limit Level] for the output voltage limit operation when C3-05 = 1 [Output Voltage Limit Selection = Enabled].	100.0% (85.0 - 100.0%)	757
C3-18 (0263) Expert	Output Voltage Limit Level	<input type="checkbox"/> V/f <input type="checkbox"/> CL-V/f <input type="checkbox"/> OLV <input type="checkbox"/> CLV <input type="checkbox"/> AOLV <input type="checkbox"/> OLV/PM <input type="checkbox"/> AOLV/PM <input type="checkbox"/> CLV/PM <input type="checkbox"/> EZOLV Sets the maximum drop width of the voltage reference when C3-05 = 1 [Output Voltage Limit Selection = Enabled].	90.0% (50.0 - 100.0%)	758

No. (Hex.)	Name	Description	Default (Range)	Ref.
C3-21 (033E) RUN	Motor 2 Slip Compensation Gain	<b>V/f</b> <b>CL-V/f</b> <b>OLV</b> <b>CLV</b> <b>AOLV</b> <b>OLV/PM</b> <b>AOLV/PM</b> <b>CLV/PM</b> <b>EZOLV</b> Sets the gain for the motor 2 slip compensation function. Usually it is not necessary to change this setting. <b>Note:</b> Correctly set these parameters before changing the slip compensation gain: • E4-01 [Motor 2 Rated Current] • E4-02 [Motor 2 Rated Slip] (Set during Auto-Tuning when E3-01 = 2 [Motor 2 Control Mode Selection = Open Loop Vector]) • E4-03 [Motor 2 Rated No-Load Current]	Determined by E3-01 (0.0 - 2.5)	758
C3-22 (0241) RUN	Motor 2 Slip Comp Delay Time	<b>V/f</b> <b>CL-V/f</b> <b>OLV</b> <b>CLV</b> <b>AOLV</b> <b>OLV/PM</b> <b>AOLV/PM</b> <b>CLV/PM</b> <b>EZOLV</b> Sets the slip compensation delay time for motor 2 when speed is unstable or when the slip compensation response is too slow. Usually it is not necessary to change this setting.	Determined by E3-01 (0 - 10000 ms)	758
C3-23 (0242)	Motor 2 Slip Compensation Limit	<b>V/f</b> <b>CL-V/f</b> <b>OLV</b> <b>CLV</b> <b>AOLV</b> <b>OLV/PM</b> <b>AOLV/PM</b> <b>CLV/PM</b> <b>EZOLV</b> Sets the upper limit for the slip compensation function as a percentage of the motor 2 rated slip.	200% (0 - 250%)	758
C3-24 (0243)	Motor 2 Slip Comp during Regen	<b>V/f</b> <b>CL-V/f</b> <b>OLV</b> <b>CLV</b> <b>AOLV</b> <b>OLV/PM</b> <b>AOLV/PM</b> <b>CLV/PM</b> <b>EZOLV</b> Sets the slip compensation during regenerative operation function for motor 2. 0 : Disabled 1 : Enabled Above 6Hz 2 : Enabled Above C3-15	0 (0 - 2)	759
C3-28 (1B5B) Expert	Adaptive Slip Control Mode	<b>V/f</b> <b>CL-V/f</b> <b>OLV</b> <b>CLV</b> <b>AOLV</b> <b>OLV/PM</b> <b>AOLV/PM</b> <b>CLV/PM</b> <b>EZOLV</b> Sets the slip compensation function mode. 0 : Normal 1 : Advanced	0 (0, 1)	759

#### ◆ C4: Torque Compensation

No. (Hex.)	Name	Description	Default (Range)	Ref.
C4-01 (0215) RUN	Torque Compensation Gain	<b>V/f</b> <b>CL-V/f</b> <b>OLV</b> <b>CLV</b> <b>AOLV</b> <b>OLV/PM</b> <b>AOLV/PM</b> <b>CLV/PM</b> <b>EZOLV</b> Sets the gain for the torque compensation function. Use this parameter value for motor 1 when operating multiple motors.	Determined by A1-02 (0.00 - 2.50)	760
C4-02 (0216) RUN	Torque Compensation Delay Time	<b>V/f</b> <b>CL-V/f</b> <b>OLV</b> <b>CLV</b> <b>AOLV</b> <b>OLV/PM</b> <b>AOLV/PM</b> <b>CLV/PM</b> <b>EZOLV</b> Sets the torque compensation delay time. Usually it is not necessary to change this setting.	Determined by A1-02 (0 - 60000 ms)	760
C4-03 (0217)	Torque Compensation @ FWD Start	<b>V/f</b> <b>CL-V/f</b> <b>OLV</b> <b>CLV</b> <b>AOLV</b> <b>OLV/PM</b> <b>AOLV/PM</b> <b>CLV/PM</b> <b>EZOLV</b> Sets the amount of torque reference for forward start as a percentage of the motor rated torque.	0.0% (0.0 - 200.0%)	760
C4-04 (0218)	Torque Compensation @ REV Start	<b>V/f</b> <b>CL-V/f</b> <b>OLV</b> <b>CLV</b> <b>AOLV</b> <b>OLV/PM</b> <b>AOLV/PM</b> <b>CLV/PM</b> <b>EZOLV</b> Sets the amount of torque reference for reverse start as a percentage of the motor rated torque.	0.0% (-200.0 - 0.0%)	760
C4-05 (0219)	Torque Compensation Time	<b>V/f</b> <b>CL-V/f</b> <b>OLV</b> <b>CLV</b> <b>AOLV</b> <b>OLV/PM</b> <b>AOLV/PM</b> <b>CLV/PM</b> <b>EZOLV</b> Sets the starting torque constant to use with C4-03 and C4-04 [Torque Compensation @ FWD/REV Start].	10 ms (0 - 200 ms)	760
C4-06 (021A)	Motor 2 Torque Comp Delay Time	<b>V/f</b> <b>CL-V/f</b> <b>OLV</b> <b>CLV</b> <b>AOLV</b> <b>OLV/PM</b> <b>AOLV/PM</b> <b>CLV/PM</b> <b>EZOLV</b> Sets the value if <i>ov</i> [Overvoltage] occurs with sudden changes in the load, at the end of acceleration, or at the start of deceleration.	150 ms (0 - 10000 ms)	761
C4-07 (0341) RUN	Motor 2 Torque Compensation Gain	<b>V/f</b> <b>CL-V/f</b> <b>OLV</b> <b>CLV</b> <b>AOLV</b> <b>OLV/PM</b> <b>AOLV/PM</b> <b>CLV/PM</b> <b>EZOLV</b> Sets the gain for motor 2 torque compensation function when using the Motor Switch function.	1.00 (0.00 - 2.50)	761
C4-19 (0B8D) Expert	Torque Ripple Suppress Min Freq	<b>V/f</b> <b>CL-V/f</b> <b>OLV</b> <b>CLV</b> <b>AOLV</b> <b>OLV/PM</b> <b>AOLV/PM</b> <b>CLV/PM</b> <b>EZOLV</b> Sets a frequency to limit current and torque ripple. Increase this parameter in 1.0 Hz increments when current ripples and torque ripples occur during low-speed operation. Set this parameter to 0.0 to disable the function if increasing the value does not fix the problem. Usually it is not necessary to change this setting.	0.1 Hz (0.0 - 10.0 Hz)	761

No. (Hex.)	Name	Description	Default (Range)	Ref.
C4-20 (0BCB) Expert	Voltage Compensation Adjust 1	<input type="checkbox"/> V/f <input type="checkbox"/> CL-V/f <input type="checkbox"/> OLV <input checked="" type="checkbox"/> CLV <input type="checkbox"/> AOLV <input type="checkbox"/> OLV/PM <input type="checkbox"/> AOLV/PM <input type="checkbox"/> CLV/PM <input type="checkbox"/> EZOLV Sets voltage precision compensation. Usually it is not necessary to change this setting.	120 (0 - 200)	761
C4-21 (0BCC) Expert	Voltage Compensation Adjust 2	<input type="checkbox"/> V/f <input type="checkbox"/> CL-V/f <input type="checkbox"/> OLV <input checked="" type="checkbox"/> CLV <input type="checkbox"/> AOLV <input type="checkbox"/> OLV/PM <input type="checkbox"/> AOLV/PM <input type="checkbox"/> CLV/PM <input type="checkbox"/> EZOLV Sets voltage precision compensation. Usually it is not necessary to change this setting.	5 (0 - 10)	762

◆ C5: Automatic Speed Regulator Automatic Speed Regulator)

No. (Hex.)	Name	Description	Default (Range)	Ref.
C5-01 (021B) RUN	ASR Proportional Gain 1	<input type="checkbox"/> V/f <input type="checkbox"/> CL-V/f <input type="checkbox"/> OLV <input checked="" type="checkbox"/> CLV <input type="checkbox"/> AOLV <input type="checkbox"/> OLV/PM <input type="checkbox"/> AOLV/PM <input type="checkbox"/> CLV/PM <input type="checkbox"/> EZOLV Sets the gain to adjust ASR response.	Determined by A1-02 (0.00 - 300.00)	765
C5-02 (021C) RUN	ASR Integral Time 1	<input type="checkbox"/> V/f <input type="checkbox"/> CL-V/f <input type="checkbox"/> OLV <input checked="" type="checkbox"/> CLV <input type="checkbox"/> AOLV <input type="checkbox"/> OLV/PM <input type="checkbox"/> AOLV/PM <input type="checkbox"/> CLV/PM <input type="checkbox"/> EZOLV Sets the ASR integral time.	Determined by A1-02 (0.000 - 60.000 s)	766
C5-03 (021D) RUN	ASR Proportional Gain 2	<input type="checkbox"/> V/f <input type="checkbox"/> CL-V/f <input type="checkbox"/> OLV <input checked="" type="checkbox"/> CLV <input type="checkbox"/> AOLV <input type="checkbox"/> OLV/PM <input type="checkbox"/> AOLV/PM <input type="checkbox"/> CLV/PM <input type="checkbox"/> EZOLV Sets the gain to adjust ASR response.	Determined by A1-02 (0.00 - 300.00)	766
C5-04 (021E) RUN	ASR Integral Time 2	<input type="checkbox"/> V/f <input type="checkbox"/> CL-V/f <input type="checkbox"/> OLV <input checked="" type="checkbox"/> CLV <input type="checkbox"/> AOLV <input type="checkbox"/> OLV/PM <input type="checkbox"/> AOLV/PM <input type="checkbox"/> CLV/PM <input type="checkbox"/> EZOLV Sets the ASR integral time.	Determined by A1-02 (0.000 - 60.000 s)	766
C5-05 (021F)	ASR Limit	<input type="checkbox"/> V/f <input type="checkbox"/> CL-V/f <input type="checkbox"/> OLV <input checked="" type="checkbox"/> CLV <input type="checkbox"/> AOLV <input type="checkbox"/> OLV/PM <input type="checkbox"/> AOLV/PM <input type="checkbox"/> CLV/PM <input type="checkbox"/> EZOLV Sets the ASR output limit as a percentage of E1-04 [Maximum Output Frequency].	5.0% (0.0 - 20.0%)	766
C5-06 (0220)	ASR Delay Time	<input type="checkbox"/> V/f <input type="checkbox"/> CL-V/f <input type="checkbox"/> OLV <input checked="" type="checkbox"/> CLV <input type="checkbox"/> AOLV <input type="checkbox"/> OLV/PM <input type="checkbox"/> AOLV/PM <input type="checkbox"/> CLV/PM <input type="checkbox"/> EZOLV Sets the filter time constant for the time from the speed loop to the torque command output. Usually it is not necessary to change this setting.	Determined by A1-02 (0.000 - 0.500 s)	766
C5-07 (0221)	ASR Gain Switchover Frequency	<input type="checkbox"/> V/f <input type="checkbox"/> CL-V/f <input type="checkbox"/> OLV <input checked="" type="checkbox"/> CLV <input type="checkbox"/> AOLV <input type="checkbox"/> OLV/PM <input type="checkbox"/> AOLV/PM <input type="checkbox"/> CLV/PM <input type="checkbox"/> EZOLV Sets the frequency where the drive will switch between these parameters: C5-01 and C5-03 [ASR Proportional Gain 1/2] C5-02 and C5-04 [ASR Integral Time 1/2]	Determined by A1-02 (Determined by A1-02)	767
C5-08 (0222)	ASR Integral Limit	<input type="checkbox"/> V/f <input type="checkbox"/> CL-V/f <input type="checkbox"/> OLV <input checked="" type="checkbox"/> CLV <input type="checkbox"/> AOLV <input type="checkbox"/> OLV/PM <input type="checkbox"/> AOLV/PM <input type="checkbox"/> CLV/PM <input type="checkbox"/> EZOLV Sets the upper limit for ASR as a percentage of the rated load.	400% (0 - 400%)	767
C5-12 (0386)	Integral Operation @ Accel/Decel	<input type="checkbox"/> V/f <input type="checkbox"/> CL-V/f <input type="checkbox"/> OLV <input checked="" type="checkbox"/> CLV <input type="checkbox"/> AOLV <input type="checkbox"/> OLV/PM <input type="checkbox"/> AOLV/PM <input type="checkbox"/> CLV/PM <input type="checkbox"/> EZOLV Sets integral operation during acceleration and deceleration. 0 : Disabled 1 : Enabled	0 (0, 1)	767
C5-17 (0276) Expert	Motor Inertia	<input type="checkbox"/> V/f <input type="checkbox"/> CL-V/f <input type="checkbox"/> OLV <input checked="" type="checkbox"/> CLV <input type="checkbox"/> AOLV <input type="checkbox"/> OLV/PM <input type="checkbox"/> AOLV/PM <input type="checkbox"/> CLV/PM <input type="checkbox"/> EZOLV Sets the motor inertia.	Determined by o2-04, C6-01, and E5-01 (0.0001 - 6.0000 kgm <sup>2</sup> )	767
C5-18 (0277) Expert	Load Inertia Ratio	<input type="checkbox"/> V/f <input type="checkbox"/> CL-V/f <input type="checkbox"/> OLV <input checked="" type="checkbox"/> CLV <input type="checkbox"/> AOLV <input type="checkbox"/> OLV/PM <input type="checkbox"/> AOLV/PM <input type="checkbox"/> CLV/PM <input type="checkbox"/> EZOLV Sets the load inertia ratio for the motor inertia.	1.0 (0.0 - 6000.0)	767
C5-21 (0356) RUN	Motor 2 ASR Proportional Gain 1	<input type="checkbox"/> V/f <input type="checkbox"/> CL-V/f <input type="checkbox"/> OLV <input checked="" type="checkbox"/> CLV <input type="checkbox"/> AOLV <input type="checkbox"/> OLV/PM <input type="checkbox"/> AOLV/PM <input type="checkbox"/> CLV/PM <input type="checkbox"/> EZOLV Sets the gain to adjust ASR response for motor 2.	Determined by E3-01 (0.00 - 300.00)	768
C5-22 (0357) RUN	Motor 2 ASR Integral Time 1	<input type="checkbox"/> V/f <input type="checkbox"/> CL-V/f <input type="checkbox"/> OLV <input checked="" type="checkbox"/> CLV <input type="checkbox"/> AOLV <input type="checkbox"/> OLV/PM <input type="checkbox"/> AOLV/PM <input type="checkbox"/> CLV/PM <input type="checkbox"/> EZOLV Sets the ASR integral time for motor 2.	Determined by E3-01 (0.000 - 60.000 s)	768

No. (Hex.)	Name	Description	Default (Range)	Ref.
C5-23 (0358) RUN	Motor 2 ASR Proportional Gain 2	<input type="checkbox"/> V/f <input checked="" type="checkbox"/> CL-V/f <input type="checkbox"/> OLV <input checked="" type="checkbox"/> CLV <input type="checkbox"/> AOLV <input type="checkbox"/> OLV/PM <input type="checkbox"/> AOLV/PM <input type="checkbox"/> CLV/PM <input type="checkbox"/> EZOLV Sets the gain to adjust ASR response for motor 2.	Determined by E3-01 (0.00 - 300.00)	768
C5-24 (0359) RUN	Motor 2 ASR Integral Time 2	<input type="checkbox"/> V/f <input checked="" type="checkbox"/> CL-V/f <input type="checkbox"/> OLV <input checked="" type="checkbox"/> CLV <input type="checkbox"/> AOLV <input type="checkbox"/> OLV/PM <input type="checkbox"/> AOLV/PM <input type="checkbox"/> CLV/PM <input type="checkbox"/> EZOLV Sets the ASR integral time for motor 2.	Determined by E3-01 (0.000 - 60.000 s)	768
C5-25 (035A)	Motor 2 ASR Limit	<input type="checkbox"/> V/f <input checked="" type="checkbox"/> CL-V/f <input type="checkbox"/> OLV <input type="checkbox"/> CLV <input type="checkbox"/> AOLV <input type="checkbox"/> OLV/PM <input type="checkbox"/> AOLV/PM <input type="checkbox"/> CLV/PM <input type="checkbox"/> EZOLV Sets the ASR output limit for motor 2 as a percentage of <i>E1-04 [Maximum Output Frequency]</i> .	5.0% (0.0 - 20.0%)	769
C5-26 (035B)	Motor 2 ASR Delay Time	<input type="checkbox"/> V/f <input type="checkbox"/> CL-V/f <input type="checkbox"/> OLV <input checked="" type="checkbox"/> CLV <input type="checkbox"/> AOLV <input type="checkbox"/> OLV/PM <input type="checkbox"/> AOLV/PM <input type="checkbox"/> CLV/PM <input type="checkbox"/> EZOLV Sets the filter time constant for the time from the speed loop to the torque command output for motor 2. Usually it is not necessary to change this setting.	Determined by E3-01 (0.000 - 0.500 s)	769
C5-27 (035C)	Motor 2 ASR Gain Switchover Freq	<input type="checkbox"/> V/f <input type="checkbox"/> CL-V/f <input type="checkbox"/> OLV <input checked="" type="checkbox"/> CLV <input type="checkbox"/> AOLV <input type="checkbox"/> OLV/PM <input type="checkbox"/> AOLV/PM <input type="checkbox"/> CLV/PM <input type="checkbox"/> EZOLV Sets the frequency where the drive will switch between these parameters: <i>C5-21 and C5-23 [Motor 2 ASR Proportional Gain 1/2] C5-22 and C5-24 [Motor 2 ASR Integral Time 1/2]</i>	0.0 (0.0 - 400.0)	769
C5-28 (035D)	Motor 2 ASR Integral Limit	<input type="checkbox"/> V/f <input type="checkbox"/> CL-V/f <input type="checkbox"/> OLV <input checked="" type="checkbox"/> CLV <input type="checkbox"/> AOLV <input type="checkbox"/> OLV/PM <input type="checkbox"/> AOLV/PM <input type="checkbox"/> CLV/PM <input type="checkbox"/> EZOLV Sets the upper limit for ASR for motor 2 as a percentage of the rated load.	400% (0 - 400%)	769
C5-29 (0B18) Expert	Speed Control Response	<input checked="" type="checkbox"/> V/f <input type="checkbox"/> CL-V/f <input type="checkbox"/> OLV <input type="checkbox"/> CLV <input type="checkbox"/> AOLV <input type="checkbox"/> OLV/PM <input type="checkbox"/> AOLV/PM <input type="checkbox"/> CLV/PM <input type="checkbox"/> EZOLV Sets the level of speed control responsiveness. Usually it is not necessary to change this setting. 0 : Standard 1 : High Performance 1	0 (0, 1)	769
C5-32 (0361)	Motor 2 Integral Oper at Acc/Dec	<input type="checkbox"/> V/f <input checked="" type="checkbox"/> CL-V/f <input type="checkbox"/> OLV <input type="checkbox"/> CLV <input type="checkbox"/> AOLV <input type="checkbox"/> OLV/PM <input type="checkbox"/> AOLV/PM <input type="checkbox"/> CLV/PM <input type="checkbox"/> EZOLV Sets integral operation during acceleration and deceleration for motor 2. 0 : Disabled 1 : Enabled	0 (0, 1)	770
C5-37 (0278) Expert	Motor 2 Inertia	<input type="checkbox"/> V/f <input type="checkbox"/> CL-V/f <input type="checkbox"/> OLV <input checked="" type="checkbox"/> CLV <input type="checkbox"/> AOLV <input type="checkbox"/> OLV/PM <input type="checkbox"/> AOLV/PM <input type="checkbox"/> CLV/PM <input type="checkbox"/> EZOLV Sets the motor inertia for motor 2.	Determined by o2-04 and C6-01 (0.0001 - 6.0000 kgm <sup>2</sup> )	770
C5-38 (0279) Expert	Motor 2 Load Inertia Ratio	<input type="checkbox"/> V/f <input type="checkbox"/> CL-V/f <input type="checkbox"/> OLV <input checked="" type="checkbox"/> CLV <input type="checkbox"/> AOLV <input type="checkbox"/> OLV/PM <input type="checkbox"/> AOLV/PM <input type="checkbox"/> CLV/PM <input type="checkbox"/> EZOLV Sets the load inertia ratio for the motor 2 inertia.	1.0 (0.0 - 6000.0)	770
C5-39 (030D)	ASR Primary Delay Time Const 2	<input type="checkbox"/> V/f <input type="checkbox"/> CL-V/f <input type="checkbox"/> OLV <input type="checkbox"/> CLV <input type="checkbox"/> AOLV <input type="checkbox"/> OLV/PM <input type="checkbox"/> AOLV/PM <input type="checkbox"/> CLV/PM <input type="checkbox"/> EZOLV Sets the filter time constant for the time from the speed loop to the torque command output for motor 2. Usually it is not necessary to change this setting.	0.000 s (0.000 - 0.500 s)	770
C5-50 (0B14) Expert	Notch Filter Frequency	<input type="checkbox"/> V/f <input type="checkbox"/> CL-V/f <input type="checkbox"/> OLV <input checked="" type="checkbox"/> CLV <input type="checkbox"/> AOLV <input type="checkbox"/> OLV/PM <input type="checkbox"/> AOLV/PM <input checked="" type="checkbox"/> CLV/PM <input type="checkbox"/> EZOLV Sets the machine resonance frequency. <b>Note:</b> Set this parameter to 0 Hz to disable the notch filter.	0 Hz (0, or 2 to 100 Hz)	770
C5-51 (0B15) Expert	Notch Filter Bandwidth	<input type="checkbox"/> V/f <input type="checkbox"/> CL-V/f <input type="checkbox"/> OLV <input checked="" type="checkbox"/> CLV <input type="checkbox"/> AOLV <input type="checkbox"/> OLV/PM <input type="checkbox"/> AOLV/PM <input type="checkbox"/> CLV/PM <input type="checkbox"/> EZOLV Sets the notch width of the notch filter. <b>Note:</b> Set this parameter to 0.0 to disable the function.	1.0 (0.5 - 5.0)	771

## ◆ C6: Duty & Carrier Frequency

No. (Hex.)	Name	Description	Default (Range)	Ref.
C6-01 (0223)	Normal / Heavy Duty Selection	<p><b>V/f</b> <b>CL-V/f</b> <b>OLV</b> <b>CLV</b> <b>AOLV</b> <b>OLV/PM</b> <b>AOLV/PM</b> <b>CLV/PM</b> <b>EZOLV</b></p> <p>Sets the drive duty rating.            0 : Heavy Duty Rating            1 : Normal Duty Rating</p>	0 (0, 1)	771
C6-02 (0224)	Carrier Frequency Selection	<p><b>V/f</b> <b>CL-V/f</b> <b>OLV</b> <b>CLV</b> <b>AOLV</b> <b>OLV/PM</b> <b>AOLV/PM</b> <b>CLV/PM</b> <b>EZOLV</b></p> <p>Sets the carrier frequency for the transistors in the drive.            1 : 2.0 kHz            2 : 5.0 kHz (4.0 kHz for AOLV/PM)            3 : 8.0 kHz (6.0 kHz for AOLV/PM)            4 : 10.0 kHz (8.0 kHz for AOLV/PM)            5 : 12.5 kHz (10.0 kHz for AOLV/PM)            6 : 15.0 kHz (12.0 kHz AOLV/PM)            7 : Swing PWM1 (Audible Sound 1)            8 : Swing PWM2 (Audible Sound 2)            9 : Swing PWM3 (Audible Sound 3)            A : Swing PWM4 (Audible Sound 4)            F : User Defined (C6-03 to C6-05)</p> <p><b>Note:</b>            The carrier frequency for Swing PWM 1 to 4 is equivalent to 2.0 kHz.</p>	Determined by A1-02, C6-01, and o2-04  (Determined by A1-02)	772
C6-03 (0225)	Carrier Frequency Upper Limit	<p><b>V/f</b> <b>CL-V/f</b> <b>OLV</b> <b>CLV</b> <b>AOLV</b> <b>OLV/PM</b> <b>AOLV/PM</b> <b>CLV/PM</b> <b>EZOLV</b></p> <p>Sets the upper limit of the carrier frequency. Set <math>C6-02 = F</math> [Carrier Frequency Selection = User Defined (C6-03 to C6-05)] to set this parameter.</p>	Determined by C6-02 (1.0 - 15.0 kHz)	773
C6-04 (0226)	Carrier Frequency Lower Limit	<p><b>V/f</b> <b>CL-V/f</b> <b>OLV</b> <b>CLV</b> <b>AOLV</b> <b>OLV/PM</b> <b>AOLV/PM</b> <b>CLV/PM</b> <b>EZOLV</b></p> <p>Sets the lower limit of the carrier frequency. Set <math>C6-02 = F</math> [Carrier Frequency Selection = User Defined (C6-03 to C6-05)] to set this parameter.</p>	Determined by C6-02 (1.0 - 15.0 kHz)	773
C6-05 (0227)	Carrier Freq Proportional Gain	<p><b>V/f</b> <b>CL-V/f</b> <b>OLV</b> <b>CLV</b> <b>AOLV</b> <b>OLV/PM</b> <b>AOLV/PM</b> <b>CLV/PM</b> <b>EZOLV</b></p> <p>Sets the proportional gain for the carrier frequency. Set <math>C6-02 = F</math> [Carrier Frequency Selection = User Defined (C6-03 to C6-05)] to set this parameter.</p>	Determined by C6-02 (0 - 99)	774
C6-09 (022B)	Carrier Freq at Rotational Tune	<p><b>V/f</b> <b>CL-V/f</b> <b>OLV</b> <b>CLV</b> <b>AOLV</b> <b>OLV/PM</b> <b>AOLV/PM</b> <b>CLV/PM</b> <b>EZOLV</b></p> <p>Sets the Auto-Tuning carrier frequency. Usually it is not necessary to change this setting.            0 : 5kHz            1 : use C6-03</p>	0 (0, 1)	774

## 10.7 d: Reference Settings

### ◆ d1: Frequency Reference

No. (Hex.)	Name	Description	Default (Range)	Ref.
d1-01 (0280) RUN	Reference 1	<p><b>V/f</b> <b>CL-V/f</b> <b>OLV</b> <b>CLV</b> <b>AOLV</b> <b>OLV/PM</b> <b>AOLV/PM</b> <b>CLV/PM</b> <b>EZOLV</b></p> <p>Sets the frequency reference in the units from <i>o1-03</i> [Frequency Display Unit Selection].</p> <p><b>Note:</b> <i>o1-03</i> = 1 [0.01% (100% = <i>E1-04</i>)] when <i>A1-02</i> = 6, 7 [Control Method Selection = PM Advanced Open Loop Vector; PM Closed Loop Vector].</p>	0.00 Hz (0.00 - 590.00 Hz)	777
d1-02 (0281) RUN	Reference 2	<p><b>V/f</b> <b>CL-V/f</b> <b>OLV</b> <b>CLV</b> <b>AOLV</b> <b>OLV/PM</b> <b>AOLV/PM</b> <b>CLV/PM</b> <b>EZOLV</b></p> <p>Sets the frequency reference in the units from <i>o1-03</i> [Frequency Display Unit Selection].</p> <p><b>Note:</b> <i>o1-03</i> = 1 [0.01% (100% = <i>E1-04</i>)] when <i>A1-02</i> = 6, 7 [Control Method Selection = PM Advanced Open Loop Vector; PM Closed Loop Vector].</p>	0.00 Hz (0.00 - 590.00 Hz)	778
d1-03 (0282) RUN	Reference 3	<p><b>V/f</b> <b>CL-V/f</b> <b>OLV</b> <b>CLV</b> <b>AOLV</b> <b>OLV/PM</b> <b>AOLV/PM</b> <b>CLV/PM</b> <b>EZOLV</b></p> <p>Sets the frequency reference in the units from <i>o1-03</i> [Keypad Display Selection].</p> <p><b>Note:</b> The default setting is <i>o1-03</i> = 1 [0.01% (100% = <i>E1-04</i>)] when <i>A1-02</i> = 6, 7 [Control Method Selection = PM Advanced Open Loop Vector; PM Closed Loop Vector].</p>	0.00 Hz (0.00 - 590.00 Hz)	778
d1-04 (0283) RUN	Reference 4	<p><b>V/f</b> <b>CL-V/f</b> <b>OLV</b> <b>CLV</b> <b>AOLV</b> <b>OLV/PM</b> <b>AOLV/PM</b> <b>CLV/PM</b> <b>EZOLV</b></p> <p>Sets the frequency reference in the units from <i>o1-03</i> [Frequency Display Unit Selection].</p> <p><b>Note:</b> <i>o1-03</i> = 1 [0.01% (100% = <i>E1-04</i>)] when <i>A1-02</i> = 6, 7 [Control Method Selection = PM Advanced Open Loop Vector; PM Closed Loop Vector].</p>	0.00 Hz (0.00 - 590.00 Hz)	778
d1-05 (0284) RUN	Reference 5	<p><b>V/f</b> <b>CL-V/f</b> <b>OLV</b> <b>CLV</b> <b>AOLV</b> <b>OLV/PM</b> <b>AOLV/PM</b> <b>CLV/PM</b> <b>EZOLV</b></p> <p>Sets the frequency reference in the units from <i>o1-03</i> [Frequency Display Unit Selection].</p> <p><b>Note:</b> <i>o1-03</i> = 1 [0.01% (100% = <i>E1-04</i>)] when <i>A1-02</i> = 6, 7 [Control Method Selection = PM Advanced Open Loop Vector; PM Closed Loop Vector].</p>	0.00 Hz (0.00 - 590.00 Hz)	778
d1-06 (0285) RUN	Reference 6	<p><b>V/f</b> <b>CL-V/f</b> <b>OLV</b> <b>CLV</b> <b>AOLV</b> <b>OLV/PM</b> <b>AOLV/PM</b> <b>CLV/PM</b> <b>EZOLV</b></p> <p>Sets the frequency reference in the units from <i>o1-03</i> [Frequency Display Unit Selection].</p> <p><b>Note:</b> <i>o1-03</i> = 1 [0.01% (100% = <i>E1-04</i>)] when <i>A1-02</i> = 6, 7 [Control Method Selection = PM Advanced Open Loop Vector; PM Closed Loop Vector].</p>	0.00 Hz (0.00 - 590.00 Hz)	779
d1-07 (0286) RUN	Reference 7	<p><b>V/f</b> <b>CL-V/f</b> <b>OLV</b> <b>CLV</b> <b>AOLV</b> <b>OLV/PM</b> <b>AOLV/PM</b> <b>CLV/PM</b> <b>EZOLV</b></p> <p>Sets the frequency reference in the units from <i>o1-03</i> [Frequency Display Unit Selection].</p> <p><b>Note:</b> <i>o1-03</i> = 1 [0.01% (100% = <i>E1-04</i>)] when <i>A1-02</i> = 6, 7 [Control Method Selection = PM Advanced Open Loop Vector; PM Closed Loop Vector].</p>	0.00 Hz (0.00 - 590.00 Hz)	779
d1-08 (0287) RUN	Reference 8	<p><b>V/f</b> <b>CL-V/f</b> <b>OLV</b> <b>CLV</b> <b>AOLV</b> <b>OLV/PM</b> <b>AOLV/PM</b> <b>CLV/PM</b> <b>EZOLV</b></p> <p>Sets the frequency reference in the units from <i>o1-03</i> [Frequency Display Unit Selection].</p> <p><b>Note:</b> <i>o1-03</i> = 1 [0.01% (100% = <i>E1-04</i>)] when <i>A1-02</i> = 6, 7 [Control Method Selection = PM Advanced Open Loop Vector; PM Closed Loop Vector].</p>	0.00 Hz (0.00 - 590.00 Hz)	779

## 10.7 d: Reference Settings

No. (Hex.)	Name	Description	Default (Range)	Ref.
d1-09 (0288) RUN	Reference 9	<p><b>V/f</b> <b>CL-V/f</b> <b>OLV</b> <b>CLV</b> <b>AOLV</b> <b>OLV/PM</b> <b>AOLV/PM</b> <b>CLV/PM</b> <b>EZOLV</b></p> <p>Sets the frequency reference in the units from o1-03 [Frequency Display Unit Selection].</p> <p><b>Note:</b> o1-03 = 1 [0.01% (100% = E1-04)] when A1-02 = 6, 7 [Control Method Selection = PM Advanced Open Loop Vector, PM Closed Loop Vector].</p>	0.00 Hz (0.00 - 590.00 Hz)	779
d1-10 (028B) RUN	Reference 10	<p><b>V/f</b> <b>CL-V/f</b> <b>OLV</b> <b>CLV</b> <b>AOLV</b> <b>OLV/PM</b> <b>AOLV/PM</b> <b>CLV/PM</b> <b>EZOLV</b></p> <p>Sets the frequency reference in the units from o1-03 [Frequency Display Unit Selection].</p> <p><b>Note:</b> o1-03 = 1 [0.01% (100% = E1-04)] when A1-02 = 6, 7 [Control Method Selection = PM Advanced Open Loop Vector, PM Closed Loop Vector].</p>	0.00 Hz (0.00 - 590.00 Hz)	780
d1-11 (028C) RUN	Reference 11	<p><b>V/f</b> <b>CL-V/f</b> <b>OLV</b> <b>CLV</b> <b>AOLV</b> <b>OLV/PM</b> <b>AOLV/PM</b> <b>CLV/PM</b> <b>EZOLV</b></p> <p>Sets the frequency reference in the units from o1-03 [Frequency Display Unit Selection].</p> <p><b>Note:</b> o1-03 = 1 [0.01% (100% = E1-04)] when A1-02 = 6, 7 [Control Method Selection = PM Advanced Open Loop Vector, PM Closed Loop Vector].</p>	0.00 Hz (0.00 - 590.00 Hz)	780
d1-12 (028D) RUN	Reference 12	<p><b>V/f</b> <b>CL-V/f</b> <b>OLV</b> <b>CLV</b> <b>AOLV</b> <b>OLV/PM</b> <b>AOLV/PM</b> <b>CLV/PM</b> <b>EZOLV</b></p> <p>Sets the frequency reference in the units from o1-03 [Frequency Display Unit Selection].</p> <p><b>Note:</b> o1-03 = 1 [0.01% (100% = E1-04)] when A1-02 = 6, 7 [Control Method Selection = PM Advanced Open Loop Vector, PM Closed Loop Vector].</p>	0.00 Hz (0.00 - 590.00 Hz)	780
d1-13 (028E) RUN	Reference 13	<p><b>V/f</b> <b>CL-V/f</b> <b>OLV</b> <b>CLV</b> <b>AOLV</b> <b>OLV/PM</b> <b>AOLV/PM</b> <b>CLV/PM</b> <b>EZOLV</b></p> <p>Sets the frequency reference in the units from o1-03 [Frequency Display Unit Selection].</p> <p><b>Note:</b> o1-03 = 1 [0.01% (100% = E1-04)] when A1-02 = 6, 7 [Control Method Selection = PM Advanced Open Loop Vector, PM Closed Loop Vector].</p>	0.00 Hz (0.00 - 590.00 Hz)	780
d1-14 (028F) RUN	Reference 14	<p><b>V/f</b> <b>CL-V/f</b> <b>OLV</b> <b>CLV</b> <b>AOLV</b> <b>OLV/PM</b> <b>AOLV/PM</b> <b>CLV/PM</b> <b>EZOLV</b></p> <p>Sets the frequency reference in the units from o1-03 [Frequency Display Unit Selection].</p> <p><b>Note:</b> o1-03 = 1 [0.01% (100% = E1-04)] when A1-02 = 6, 7 [Control Method Selection = PM Advanced Open Loop Vector, PM Closed Loop Vector].</p>	0.00 Hz (0.00 - 590.00 Hz)	781
d1-15 (0290) RUN	Reference 15	<p><b>V/f</b> <b>CL-V/f</b> <b>OLV</b> <b>CLV</b> <b>AOLV</b> <b>OLV/PM</b> <b>AOLV/PM</b> <b>CLV/PM</b> <b>EZOLV</b></p> <p>Sets the frequency reference in the units from o1-03 [Frequency Display Unit Selection].</p> <p><b>Note:</b> o1-03 = 1 [0.01% (100% = E1-04)] when A1-02 = 6, 7 [Control Method Selection = PM Advanced Open Loop Vector, PM Closed Loop Vector].</p>	0.00 Hz (0.00 - 590.00 Hz)	781



No. (Hex.)	Name	Description	Default (Range)	Ref.
d1-16 (0291) RUN	Reference 16	<p><b>V/f</b> <b>CL-V/f</b> <b>OLV</b> <b>CLV</b> <b>AOLV</b> <b>OLV/PM</b> <b>AOLV/PM</b> <b>CLV/PM</b> <b>EZOLV</b></p> <p>Sets the frequency reference in the units from <i>o1-03</i> [Frequency Display Unit Selection].</p> <p><b>Note:</b> <i>o1-03 = 1</i> [0.01% (100% = <i>E1-04</i>)] when <i>A1-02 = 6, 7</i> [Control Method Selection = PM Advanced Open Loop Vector; PM Closed Loop Vector].</p>	0.00 Hz (0.00 - 590.00 Hz)	781
d1-17 (0292) RUN	Jog Reference	<p><b>V/f</b> <b>CL-V/f</b> <b>OLV</b> <b>CLV</b> <b>AOLV</b> <b>OLV/PM</b> <b>AOLV/PM</b> <b>CLV/PM</b> <b>EZOLV</b></p> <p>Sets the JOG frequency reference in the units from <i>o1-03</i> [Frequency Display Unit Selection]. Set <i>H1-xx = 6</i> [MFDDI Function Select = Jog Reference Selection] to use the Jog frequency reference.</p> <p><b>Note:</b> <i>o1-03 = 1</i> [0.01% (100% = <i>E1-04</i>)] when <i>A1-02 = 6, 7</i> [Control Method Selection = PM Advanced Open Loop Vector; PM Closed Loop Vector].</p>	6.00 Hz (0.00 - 590.00 Hz)	781

### ◆ d2: Reference Limits

No. (Hex.)	Name	Description	Default (Range)	Ref.
d2-01 (0289)	Frequency Reference Upper Limit	<p><b>V/f</b> <b>CL-V/f</b> <b>OLV</b> <b>CLV</b> <b>AOLV</b> <b>OLV/PM</b> <b>AOLV/PM</b> <b>CLV/PM</b> <b>EZOLV</b></p> <p>Sets maximum limit for all frequency references. This value is a percentage of <i>E1-04</i> [Maximum Output Frequency].</p>	100.0% (0.0 - 110.0%)	782
d2-02 (028A)	Frequency Reference Lower Limit	<p><b>V/f</b> <b>CL-V/f</b> <b>OLV</b> <b>CLV</b> <b>AOLV</b> <b>OLV/PM</b> <b>AOLV/PM</b> <b>CLV/PM</b> <b>EZOLV</b></p> <p>Sets minimum limit for all frequency references. This value is a percentage of <i>E1-04</i> [Maximum Output Frequency].</p>	0.0% (0.0 - 110.0%)	782
d2-03 (0293)	Analog Frequency Ref Lower Limit	<p><b>V/f</b> <b>CL-V/f</b> <b>OLV</b> <b>CLV</b> <b>AOLV</b> <b>OLV/PM</b> <b>AOLV/PM</b> <b>CLV/PM</b> <b>EZOLV</b></p> <p>Sets the lower limit of the master frequency reference (Multi-Step Speed 1) as a percentage of <i>E1-04</i> [Maximum Output Frequency].</p>	0.0% (0.0 - 110.0%)	782

### ◆ d3: Jump Frequency

No. (Hex.)	Name	Description	Default (Range)	Ref.
d3-01 (0294)	Jump Frequency 1	<p><b>V/f</b> <b>CL-V/f</b> <b>OLV</b> <b>CLV</b> <b>AOLV</b> <b>OLV/PM</b> <b>AOLV/PM</b> <b>CLV/PM</b> <b>EZOLV</b></p> <p>Sets the median value of the frequency band that the drive will avoid.</p>	0.0 Hz (Determined by A1-02)	783
d3-02 (0295)	Jump Frequency 2	<p><b>V/f</b> <b>CL-V/f</b> <b>OLV</b> <b>CLV</b> <b>AOLV</b> <b>OLV/PM</b> <b>AOLV/PM</b> <b>CLV/PM</b> <b>EZOLV</b></p> <p>Sets the median value of the frequency band that the drive will avoid.</p>	0.0 Hz (Determined by A1-02)	783
d3-03 (0296)	Jump Frequency 3	<p><b>V/f</b> <b>CL-V/f</b> <b>OLV</b> <b>CLV</b> <b>AOLV</b> <b>OLV/PM</b> <b>AOLV/PM</b> <b>CLV/PM</b> <b>EZOLV</b></p> <p>Sets the median value of the frequency band that the drive will avoid.</p>	0.0 Hz (Determined by A1-02)	783
d3-04 (0297)	Jump Frequency Width	<p><b>V/f</b> <b>CL-V/f</b> <b>OLV</b> <b>CLV</b> <b>AOLV</b> <b>OLV/PM</b> <b>AOLV/PM</b> <b>CLV/PM</b> <b>EZOLV</b></p> <p>Sets the width of the frequency band that the drive will avoid.</p>	1.0 Hz (Determined by A1-02)	784

### ◆ d4: Frequency Reference Hold and Up/Down 2 Function

No. (Hex.)	Name	Description	Default (Range)	Ref.
d4-01 (0298)	Freq Reference Hold Selection	<p><b>V/f</b> <b>CL-V/f</b> <b>OLV</b> <b>CLV</b> <b>AOLV</b> <b>OLV/PM</b> <b>AOLV/PM</b> <b>CLV/PM</b> <b>EZOLV</b></p> <p>Sets the function that saves the frequency reference or the frequency bias (Up/Down 2) after a Stop command or when de-energizing the drive.</p> <p>Set <i>H1-xx</i> [<i>MFDI Function Select</i>] to one of the these values to operate this parameter:</p> <ul style="list-style-type: none"> <li>• <i>A</i> [<i>Accel/Decel Ramp Hold</i>]</li> <li>• <i>10/11</i> [<i>Up/Down Command</i>]</li> <li>• <i>75/76</i> [<i>Up/Down 2 Command</i>]</li> </ul> <p>0 : Disabled 1 : Enabled</p>	0 (0, 1)	784
d4-03 (02AA) RUN	Up/Down 2 Bias Step Frequency	<p><b>V/f</b> <b>CL-V/f</b> <b>OLV</b> <b>CLV</b> <b>AOLV</b> <b>OLV/PM</b> <b>AOLV/PM</b> <b>CLV/PM</b> <b>EZOLV</b></p> <p>Sets the bias that the Up/Down 2 function adds to or subtracts from the frequency reference.</p>	0.00 Hz (0.00 - 99.99 Hz)	786
d4-04 (02AB) RUN	Up/Down 2 Ramp Selection	<p><b>V/f</b> <b>CL-V/f</b> <b>OLV</b> <b>CLV</b> <b>AOLV</b> <b>OLV/PM</b> <b>AOLV/PM</b> <b>CLV/PM</b> <b>EZOLV</b></p> <p>Sets the acceleration and deceleration times for the Up/Down 2 function to apply the bias to the frequency reference.</p> <p>0 : Use Selected Accel/Decel Time 1 : Use Accel/Decel Time 4</p>	0 (0, 1)	786
d4-05 (02AC) RUN	Up/Down 2 Bias Mode Selection	<p><b>V/f</b> <b>CL-V/f</b> <b>OLV</b> <b>CLV</b> <b>AOLV</b> <b>OLV/PM</b> <b>AOLV/PM</b> <b>CLV/PM</b> <b>EZOLV</b></p> <p>Sets the function that saves the bias value to the drive when you open or close the two <i>Up/Down 2 Commands</i> [<i>H1-xx = 75, 76</i>]. Set <i>d4-03</i> [<i>Up/Down 2 Bias Step Frequency</i>] = 0.00 before you set this parameter.</p> <p>0 : Hold when Neither Up/Down Closed 1 : Reset when Neither / Both Closed</p>	0 (0, 1)	787
d4-06 (02AD)	Frequency Ref Bias (Up/Down 2)	<p><b>V/f</b> <b>CL-V/f</b> <b>OLV</b> <b>CLV</b> <b>AOLV</b> <b>OLV/PM</b> <b>AOLV/PM</b> <b>CLV/PM</b> <b>EZOLV</b></p> <p>Saves the bias value from the Up/Down 2 Command when the value set in <i>E1-04</i> is 100%.</p>	0.0% (-99.9 - +100.0%)	787
d4-07 (02AE) RUN	Analog Freq Ref Fluctuate Limit	<p><b>V/f</b> <b>CL-V/f</b> <b>OLV</b> <b>CLV</b> <b>AOLV</b> <b>OLV/PM</b> <b>AOLV/PM</b> <b>CLV/PM</b> <b>EZOLV</b></p> <p>If the frequency reference changes for more than the level set to this parameter, then the bias value will be held. Parameter <i>E1-04</i> [<i>Maximum Output Frequency</i>] is 100%.</p>	1.0% (0.1 - 100.0%)	787
d4-08 (02AF) RUN	Up/Down 2 Bias Upper Limit	<p><b>V/f</b> <b>CL-V/f</b> <b>OLV</b> <b>CLV</b> <b>AOLV</b> <b>OLV/PM</b> <b>AOLV/PM</b> <b>CLV/PM</b> <b>EZOLV</b></p> <p>Sets the upper limit of the Up/Down 2 bias as a percentage of <i>E1-04</i> [<i>Maximum Output Frequency</i>].</p>	100.0% (0.0 - 100.0%)	788
d4-09 (02B0) RUN	Up/Down 2 Bias Lower Limit	<p><b>V/f</b> <b>CL-V/f</b> <b>OLV</b> <b>CLV</b> <b>AOLV</b> <b>OLV/PM</b> <b>AOLV/PM</b> <b>CLV/PM</b> <b>EZOLV</b></p> <p>Sets the lower limit of the Up/Down 2 bias as a percentage of <i>E1-04</i> [<i>Maximum Output Frequency</i>].</p>	0.0% (-99.9 - 0.0%)	788
d4-10 (02B6)	Up/Down Freq Lower Limit Select	<p><b>V/f</b> <b>CL-V/f</b> <b>OLV</b> <b>CLV</b> <b>AOLV</b> <b>OLV/PM</b> <b>AOLV/PM</b> <b>CLV/PM</b> <b>EZOLV</b></p> <p>Sets the lower frequency limit for the Up/Down function.</p> <p>0 : Greater of d2-02 or Analog 1 : d2-02</p>	0 (0, 1)	788
d4-11 (02B7)	Bi-directional Output Selection	<p><b>V/f</b> <b>CL-V/f</b> <b>OLV</b> <b>CLV</b> <b>AOLV</b> <b>OLV/PM</b> <b>AOLV/PM</b> <b>CLV/PM</b> <b>EZOLV</b></p> <p>Sets the function that changes the frequency reference to a Bi-Directional internal frequency reference.</p> <p>0 : Disabled 1 : Enabled</p>	0 (0, 1)	788
d4-12 (02B8)	Stop Position Gain	<p><b>V/f</b> <b>CL-V/f</b> <b>OLV</b> <b>CLV</b> <b>AOLV</b> <b>OLV/PM</b> <b>AOLV/PM</b> <b>CLV/PM</b> <b>EZOLV</b></p> <p>Sets the gain to adjust the stopping accuracy. Set this parameter when <i>b1-03 = 9</i> [<i>Stopping Method Selection = Stop with Constant Distance</i>].</p>	1.00 (0.50 - 2.55)	790

## ◆ d5: Torque Control

No. (Hex.)	Name	Description	Default (Range)	Ref.
d5-01 (029A)	Torque Control Selection	<input type="checkbox"/> V/f <input type="checkbox"/> CL-V/f <input type="checkbox"/> OLV <input checked="" type="checkbox"/> CLV <input type="checkbox"/> AOLV <input type="checkbox"/> OLV/PM <input type="checkbox"/> AOLV/PM <input type="checkbox"/> CLV/PM <input type="checkbox"/> EZOLV Sets the drive for torque control or speed control. 0 : Speed Control 1 : Torque Control	0 (0, 1)	794
d5-02 (029B)	Torque Reference Delay Time	<input type="checkbox"/> V/f <input type="checkbox"/> CL-V/f <input type="checkbox"/> OLV <input checked="" type="checkbox"/> CLV <input type="checkbox"/> AOLV <input type="checkbox"/> OLV/PM <input type="checkbox"/> AOLV/PM <input type="checkbox"/> CLV/PM <input type="checkbox"/> EZOLV Sets the primary delay time constant for the torque reference filter.	Determined by A1-02 (0 - 1000 ms)	794
d5-03 (029C)	Speed Limit Selection	<input type="checkbox"/> V/f <input type="checkbox"/> CL-V/f <input type="checkbox"/> OLV <input checked="" type="checkbox"/> CLV <input type="checkbox"/> AOLV <input type="checkbox"/> OLV/PM <input type="checkbox"/> AOLV/PM <input type="checkbox"/> CLV/PM <input type="checkbox"/> EZOLV Sets the torque control speed limit method. 1 : Active Frequency Reference 2 : d5-04 Setting	1 (1, 2)	794
d5-04 (029D)	Speed Limit	<input type="checkbox"/> V/f <input type="checkbox"/> CL-V/f <input type="checkbox"/> OLV <input checked="" type="checkbox"/> CLV <input type="checkbox"/> AOLV <input type="checkbox"/> OLV/PM <input type="checkbox"/> AOLV/PM <input type="checkbox"/> CLV/PM <input type="checkbox"/> EZOLV Sets the speed limit during Torque Control as a percentage of E1-04 [Maximum Output Frequency]. Set d5-03 = 2 [Speed Limit Selection = d5-04 Setting] before you set this parameter.	0% (-120 - +120%)	794
d5-05 (029E)	Speed Limit Bias	<input type="checkbox"/> V/f <input type="checkbox"/> CL-V/f <input type="checkbox"/> OLV <input checked="" type="checkbox"/> CLV <input type="checkbox"/> AOLV <input type="checkbox"/> OLV/PM <input type="checkbox"/> AOLV/PM <input type="checkbox"/> CLV/PM <input type="checkbox"/> EZOLV Sets a bias to the speed limit as a percentage of E1-04 [Maximum Output Frequency].	10% (0 - 120%)	794
d5-06 (029F)	Speed/Torque Changeover Time	<input type="checkbox"/> V/f <input type="checkbox"/> CL-V/f <input type="checkbox"/> OLV <input checked="" type="checkbox"/> CLV <input type="checkbox"/> AOLV <input type="checkbox"/> OLV/PM <input type="checkbox"/> AOLV/PM <input type="checkbox"/> CLV/PM <input type="checkbox"/> EZOLV Sets the delay time to switch between Speed Control and Torque Control. Set H1-xx = 71 [MFD1 Function Select = Torque Control] before you set this parameter.	0 ms (0 - 1000 ms)	795
d5-08 (02B5)	Uni-directional Speed Limit Bias	<input type="checkbox"/> V/f <input type="checkbox"/> CL-V/f <input type="checkbox"/> OLV <input checked="" type="checkbox"/> CLV <input type="checkbox"/> AOLV <input type="checkbox"/> OLV/PM <input type="checkbox"/> AOLV/PM <input type="checkbox"/> CLV/PM <input type="checkbox"/> EZOLV Sets the direction of the speed limit reference to which Speed Limit Bias [d5-05] applies. 0 : Disabled 1 : Enabled	1 (0, 1)	795

## ◆ d6: Field Weakening and Field Forcing

No. (Hex.)	Name	Description	Default (Range)	Ref.
d6-01 (02A0)	Field Weakening Level	<input checked="" type="checkbox"/> V/f <input checked="" type="checkbox"/> CL-V/f <input type="checkbox"/> OLV <input type="checkbox"/> CLV <input type="checkbox"/> AOLV <input type="checkbox"/> OLV/PM <input type="checkbox"/> AOLV/PM <input type="checkbox"/> CLV/PM <input type="checkbox"/> EZOLV Sets the drive output voltage as a percentage of E1-05 [Maximum Output Voltage] when H1-xx = 63 [Field Weakening] is activated.	80% (0 - 100%)	795
d6-02 (02A1)	Field Weakening Frequency Limit	<input checked="" type="checkbox"/> V/f <input checked="" type="checkbox"/> CL-V/f <input type="checkbox"/> OLV <input type="checkbox"/> CLV <input type="checkbox"/> AOLV <input type="checkbox"/> OLV/PM <input type="checkbox"/> AOLV/PM <input type="checkbox"/> CLV/PM <input type="checkbox"/> EZOLV Sets the minimum output frequency to start field weakening.	0.0 Hz (0.0 - 590.0 Hz)	795
d6-03 (02A2)	Field Forcing Selection	<input type="checkbox"/> V/f <input type="checkbox"/> CL-V/f <input type="checkbox"/> OLV <input checked="" type="checkbox"/> CLV <input type="checkbox"/> AOLV <input type="checkbox"/> OLV/PM <input type="checkbox"/> AOLV/PM <input type="checkbox"/> CLV/PM <input type="checkbox"/> EZOLV Sets the field forcing function. 0 : Disabled 1 : Enabled	0 (0, 1)	796
d6-06 (02A5)	Field Forcing Limit	<input type="checkbox"/> V/f <input type="checkbox"/> CL-V/f <input type="checkbox"/> OLV <input checked="" type="checkbox"/> CLV <input type="checkbox"/> AOLV <input type="checkbox"/> OLV/PM <input type="checkbox"/> AOLV/PM <input type="checkbox"/> CLV/PM <input type="checkbox"/> EZOLV Sets the maximum level that Field Forcing can increase the excitation current reference as a percentage of E2-03 [Motor No-Load Current]. Usually it is not necessary to change this setting.	400% (100 - 400%)	796

## ◆ d7: Offset Frequency

No. (Hex.)	Name	Description	Default (Range)	Ref.
d7-01 (02B2) RUN	Offset Frequency 1	<p><b>V/f</b> <b>CL-V/f</b> <b>OLV</b> <b>CLV</b> <b>AOLV</b> <b>OLV/PM</b> <b>AOLV/PM</b> <b>CLV/PM</b> <b>EZOLV</b></p> <p>Sets the value to add to or subtract from the frequency reference when <math>H1-xx = 44</math> [MFDI Function Select = Add Offset Frequency 1 (d7-01)] as a percentage of E1-04 [Maximum Output Frequency].</p>	0.0% (-100.0 - +100.0%)	796
d7-02 (02B3) RUN	Offset Frequency 2	<p><b>V/f</b> <b>CL-V/f</b> <b>OLV</b> <b>CLV</b> <b>AOLV</b> <b>OLV/PM</b> <b>AOLV/PM</b> <b>CLV/PM</b> <b>EZOLV</b></p> <p>Sets the value to add to or subtract from the frequency reference when <math>H1-xx = 45</math> [MFDI Function Select = Add Offset Frequency 2 (d7-02)] as a percentage of E1-04 [Maximum Output Frequency].</p>	0.0% (-100.0 - +100.0%)	797
d7-03 (02B4) RUN	Offset Frequency 3	<p><b>V/f</b> <b>CL-V/f</b> <b>OLV</b> <b>CLV</b> <b>AOLV</b> <b>OLV/PM</b> <b>AOLV/PM</b> <b>CLV/PM</b> <b>EZOLV</b></p> <p>Sets the value to add to or subtract from the frequency reference when <math>H1-xx = 46</math> [MFDI Function Select = Add Offset Frequency 3 (d7-03)] as a percentage of E1-04 [Maximum Output Frequency].</p>	0.0% (-100.0 - +100.0%)	797

## 10.8 E: Motor Parameters

### ◆ E1: V/f Pattern for Motor 1

No. (Hex.)	Name	Description	Default (Range)	Ref.
E1-01 (0300)	Input AC Supply Voltage	<p><b>V/f</b> <b>CL-V/f</b> <b>OLV</b> <b>CLV</b> <b>AOLV</b> <b>OLV/PM</b> <b>AOLV/PM</b> <b>CLV/PM</b> <b>EZOLV</b></p> <p>Sets the drive input voltage.</p> <p><b>NOTICE:</b> Set this parameter to align with the drive input voltage (not motor voltage). The protective features of the drive will not function if this parameter is incorrect. Failure to obey will cause incorrect drive operation.</p>	200 V Class: 230 V, 400 V: 400 V (200 V Class: 155 to 255 V, 400 V Class: 310 to 510 V)	799
E1-03 (0302)	V/f Pattern Selection	<p><b>V/f</b> <b>CL-V/f</b> <b>OLV</b> <b>CLV</b> <b>AOLV</b> <b>OLV/PM</b> <b>AOLV/PM</b> <b>CLV/PM</b> <b>EZOLV</b></p> <p>Sets the V/f pattern for the drive and motor. You can use one of the preset patterns or you can make a custom pattern.</p> <p>0 : Const Trq, 50Hz base, 50Hz max 1 : Const Trq, 60Hz base, 60Hz max 2 : Const Trq, 50Hz base, 60Hz max 3 : Const Trq, 60Hz base, 72Hz max 4 : VT, 50Hz, 65% Vmid reduction 5 : VT, 50Hz, 50% Vmid reduction 6 : VT, 60Hz, 65% Vmid reduction 7 : VT, 60Hz, 50% Vmid reduction 8 : High Trq, 50Hz, 25% Vmin boost 9 : High Trq, 50Hz, 65% Vmin boost A : High Trq, 60Hz, 25% Vmin boost B : High Trq, 60Hz, 65% Vmin boost C : High Freq, 60Hz base, 90Hz max D : High Freq, 60Hz base, 120Hz max E : High Freq, 60Hz base, 180Hz max F : Custom</p> <p><b>Note:</b></p> <ul style="list-style-type: none"> <li>When A1-02 = 2 [Control Method Selection = Open Loop Vector], settings 0 through E are not available.</li> <li>Set the correct V/f pattern for the application and operation area. An incorrect V/f pattern can decrease motor torque and increase current from overexcitation.</li> </ul>	F (Determined by A1-02)	799
E1-04 (0303)	Maximum Output Frequency	<p><b>V/f</b> <b>CL-V/f</b> <b>OLV</b> <b>CLV</b> <b>AOLV</b> <b>OLV/PM</b> <b>AOLV/PM</b> <b>CLV/PM</b> <b>EZOLV</b></p> <p>Sets the maximum output frequency for the V/f pattern.</p>	Determined by A1-02 and E5-01 (Determined by A1-02 and E5-01)	804
E1-05 (0304)	Maximum Output Voltage	<p><b>V/f</b> <b>CL-V/f</b> <b>OLV</b> <b>CLV</b> <b>AOLV</b> <b>OLV/PM</b> <b>AOLV/PM</b> <b>CLV/PM</b> <b>EZOLV</b></p> <p>Sets the maximum output voltage for the V/f pattern.</p>	Determined by A1-02 (200 V Class: 0.0 - 255.0 V, 400 V Class: 0.0 - 510.0 V)	805
E1-06 (0305)	Base Frequency	<p><b>V/f</b> <b>CL-V/f</b> <b>OLV</b> <b>CLV</b> <b>AOLV</b> <b>OLV/PM</b> <b>AOLV/PM</b> <b>CLV/PM</b> <b>EZOLV</b></p> <p>Sets the base frequency for the V/f pattern.</p>	Determined by A1-02 and E5-01 (0.0 - E1-04)	805
E1-07 (0306)	Mid Point A Frequency	<p><b>V/f</b> <b>CL-V/f</b> <b>OLV</b> <b>CLV</b> <b>AOLV</b> <b>OLV/PM</b> <b>AOLV/PM</b> <b>CLV/PM</b> <b>EZOLV</b></p> <p>Sets a middle output frequency for the V/f pattern.</p>	Determined by A1-02 (0.0 - E1-04)	805
E1-08 (0307)	Mid Point A Voltage	<p><b>V/f</b> <b>CL-V/f</b> <b>OLV</b> <b>CLV</b> <b>AOLV</b> <b>OLV/PM</b> <b>AOLV/PM</b> <b>CLV/PM</b> <b>EZOLV</b></p> <p>Sets a middle output voltage for the V/f pattern.</p>	Determined by A1-02, C6-01 and o2-04 (200 V Class: 0.0 to 255.0 V, 400 V Class: 0.0 to 510.0 V)	805

## 10.8 E: Motor Parameters

No. (Hex.)	Name	Description	Default (Range)	Ref.
E1-09 (0308)	Minimum Output Frequency	<b>V/f</b> <b>CL-V/f</b> <b>OLV</b> <b>CLV</b> <b>AOLV</b> <b>OLV/PM</b> <b>AOLV/PM</b> <b>CLV/PM</b> <b>EZOLV</b> Sets the minimum output frequency for the V/f pattern.	Determined by A1-02 and E5-01 (Determined by A1-02, E1-04, and E5-01)	805
E1-10 (0309)	Minimum Output Voltage	<b>V/f</b> <b>CL-V/f</b> <b>OLV</b> <b>CLV</b> <b>AOLV</b> <b>OLV/PM</b> <b>AOLV/PM</b> <b>CLV/PM</b> <b>EZOLV</b> Sets the minimum output voltage for the V/f pattern.	Determined by A1-02 (200 V Class: 0.0 - 255.0 V, 400 V Class: 0.0 - 510.0 V)	805
E1-11 (030A) Expert	Mid Point B Frequency	<b>V/f</b> <b>CL-V/f</b> <b>OLV</b> <b>CLV</b> <b>AOLV</b> <b>OLV/PM</b> <b>AOLV/PM</b> <b>CLV/PM</b> <b>EZOLV</b> Sets a middle output frequency for the V/f pattern.	0.0 Hz (0.0 - E1-04)	806
E1-12 (030B) Expert	Mid Point B Voltage	<b>V/f</b> <b>CL-V/f</b> <b>OLV</b> <b>CLV</b> <b>AOLV</b> <b>OLV/PM</b> <b>AOLV/PM</b> <b>CLV/PM</b> <b>EZOLV</b> Sets a middle point voltage for the V/f pattern.	0.0 V (200 V Class: 0.0 - 255.0 V, 400 V Class: 0.0 - 510.0 V)	806
E1-13 (030C) Expert	Base Voltage	<b>V/f</b> <b>CL-V/f</b> <b>OLV</b> <b>CLV</b> <b>AOLV</b> <b>OLV/PM</b> <b>AOLV/PM</b> <b>CLV/PM</b> <b>EZOLV</b> Sets the base voltage for the V/f pattern.	0.0 V (200 V Class: 0.0 - 255.0 V, 400 V Class: 0.0 - 510.0 V)	806

## ◆ E2: Motor Parameters

No. (Hex.)	Name	Description	Default (Range)	Ref.
E2-01 (030E)	Motor Rated Current (FLA)	<b>V/f</b> <b>CL-V/f</b> <b>OLV</b> <b>CLV</b> <b>AOLV</b> <b>OLV/PM</b> <b>AOLV/PM</b> <b>CLV/PM</b> <b>EZOLV</b> Sets the motor rated current in amps.	Determined by o2-04 and C6-01 (10% to 200% of the drive rated current)	276
E2-02 (030F)	Motor Rated Slip	<b>V/f</b> <b>CL-V/f</b> <b>OLV</b> <b>CLV</b> <b>AOLV</b> <b>OLV/PM</b> <b>AOLV/PM</b> <b>CLV/PM</b> <b>EZOLV</b> Sets motor rated slip.	Determined by o2-04, C6-01 (0.000 - 20.000 Hz)	807
E2-03 (0310)	Motor No-Load Current	<b>V/f</b> <b>CL-V/f</b> <b>OLV</b> <b>CLV</b> <b>AOLV</b> <b>OLV/PM</b> <b>AOLV/PM</b> <b>CLV/PM</b> <b>EZOLV</b> Sets the no-load current for the motor in amps when operating at the rated frequency and the no-load voltage.	Determined by o2-04 and C6-01 (0 to E2-01)	807
E2-04 (0311)	Motor Pole Count	<b>V/f</b> <b>CL-V/f</b> <b>OLV</b> <b>CLV</b> <b>AOLV</b> <b>OLV/PM</b> <b>AOLV/PM</b> <b>CLV/PM</b> <b>EZOLV</b> Sets the number of motor poles. <b>Note:</b> • When A1-02 = 0, 1, 3 [Control Method Selection = V/f, CL-V/f, CLV], the maximum value is 120. • When A1-02 = 2, 4 [OLV, AOLV], the maximum value is 48.	4 (2 - 120)	807
E2-05 (0312)	Motor Line-to-Line Resistance	<b>V/f</b> <b>CL-V/f</b> <b>OLV</b> <b>CLV</b> <b>AOLV</b> <b>OLV/PM</b> <b>AOLV/PM</b> <b>CLV/PM</b> <b>EZOLV</b> Sets the line-to-line resistance for the motor stator windings.	Determined by o2-04 and C6-01 (0.000 - 65.000 Ω)	807
E2-06 (0313)	Motor Leakage Inductance	<b>V/f</b> <b>CL-V/f</b> <b>OLV</b> <b>CLV</b> <b>AOLV</b> <b>OLV/PM</b> <b>AOLV/PM</b> <b>CLV/PM</b> <b>EZOLV</b> Sets the voltage drop from motor leakage inductance when the motor is operating at the rated frequency and rated current. This value is a percentage of Motor Rated Voltage.	Determined by o2-04 and C6-01 (0.0 - 60.0%)	808
E2-07 (0314)	Motor Saturation Coefficient 1	<b>V/f</b> <b>CL-V/f</b> <b>OLV</b> <b>CLV</b> <b>AOLV</b> <b>OLV/PM</b> <b>AOLV/PM</b> <b>CLV/PM</b> <b>EZOLV</b> Set the motor iron-core saturation coefficient when the magnetic flux is 50%.	0.50 (0.00 - 0.50)	808
E2-08 (0315)	Motor Saturation Coefficient 2	<b>V/f</b> <b>CL-V/f</b> <b>OLV</b> <b>CLV</b> <b>AOLV</b> <b>OLV/PM</b> <b>AOLV/PM</b> <b>CLV/PM</b> <b>EZOLV</b> Sets the motor iron-core saturation coefficient at 75% of the magnetic flux.	0.75 (E2-07 - 0.75)	808

No. (Hex.)	Name	Description	Default (Range)	Ref.
E2-09 (0316) Expert	Motor Mechanical Loss	<input type="checkbox"/> V/f <input type="checkbox"/> CL-V/f <input checked="" type="checkbox"/> OLV <input checked="" type="checkbox"/> CLV <input type="checkbox"/> AOLV <input type="checkbox"/> OLV/PM <input type="checkbox"/> AOLV/PM <input type="checkbox"/> CLV/PM <input type="checkbox"/> EZOLV Sets the mechanical loss of the motor. Motor rated power (kw) = 100.0%. Usually it is not necessary to change this setting.	0.0% (0.0 - 10.0%)	808
E2-10 (0317)	Motor Iron Loss	<input type="checkbox"/> V/f <input type="checkbox"/> CL-V/f <input type="checkbox"/> OLV <input type="checkbox"/> CLV <input type="checkbox"/> AOLV <input type="checkbox"/> OLV/PM <input type="checkbox"/> AOLV/PM <input type="checkbox"/> CLV/PM <input type="checkbox"/> EZOLV Sets the motor iron loss.	Determined by o2-04 and C6-01 (0 - 65535 W)	808
E2-11 (0318)	Motor Rated Power (kW)	<input type="checkbox"/> V/f <input type="checkbox"/> CL-V/f <input type="checkbox"/> OLV <input type="checkbox"/> CLV <input type="checkbox"/> AOLV <input type="checkbox"/> OLV/PM <input type="checkbox"/> AOLV/PM <input type="checkbox"/> CLV/PM <input type="checkbox"/> EZOLV Sets the motor rated power in 0.01 kW increments. (1 HP = 0.746 kW)	Determined by o2-04 and C6-01 (0.00 - 650.00 kW)	809

### ◆ E3: V/f Pattern for Motor 2

No. (Hex.)	Name	Description	Default (Range)	Ref.
E3-01 (0319)	Motor 2 Control Mode Selection	<input type="checkbox"/> V/f <input type="checkbox"/> CL-V/f <input type="checkbox"/> OLV <input type="checkbox"/> CLV <input type="checkbox"/> AOLV <input type="checkbox"/> OLV/PM <input type="checkbox"/> AOLV/PM <input type="checkbox"/> CLV/PM <input type="checkbox"/> EZOLV Sets the control method for motor 2. <b>Note:</b> When you change this setting, the drive will set all parameters that are dependent on this parameter to their default settings. 0 : V/f Control 1 : V/f Control with Encoder 2 : Open Loop Vector 3 : Closed Loop Vector	0 (0 - 3)	809
E3-04 (031A)	Motor 2 Maximum Output Frequency	<input type="checkbox"/> V/f <input type="checkbox"/> CL-V/f <input type="checkbox"/> OLV <input type="checkbox"/> CLV <input type="checkbox"/> AOLV <input type="checkbox"/> OLV/PM <input type="checkbox"/> AOLV/PM <input type="checkbox"/> CLV/PM <input type="checkbox"/> EZOLV Set the maximum output frequency for the motor 2 V/f pattern.	Determined by E3-01 (40.0 - 590.0 Hz)	810
E3-05 (031B)	Motor 2 Maximum Output Voltage	<input type="checkbox"/> V/f <input type="checkbox"/> CL-V/f <input type="checkbox"/> OLV <input type="checkbox"/> CLV <input type="checkbox"/> AOLV <input type="checkbox"/> OLV/PM <input type="checkbox"/> AOLV/PM <input type="checkbox"/> CLV/PM <input type="checkbox"/> EZOLV Sets the maximum output voltage for the motor 2 V/f pattern.	Determined by E3-01 (200 V Class: 0.0 - 255.0 V, 400 V Class: 0.0 - 510.0 V)	810
E3-06 (031C)	Motor 2 Base Frequency	<input type="checkbox"/> V/f <input type="checkbox"/> CL-V/f <input type="checkbox"/> OLV <input type="checkbox"/> CLV <input type="checkbox"/> AOLV <input type="checkbox"/> OLV/PM <input type="checkbox"/> AOLV/PM <input type="checkbox"/> CLV/PM <input type="checkbox"/> EZOLV Sets the base frequency for the motor 2 V/f pattern.	Determined by E3-01 (0.0 - E3-04)	810
E3-07 (031D)	Motor 2 Mid Point A Frequency	<input type="checkbox"/> V/f <input type="checkbox"/> CL-V/f <input type="checkbox"/> OLV <input type="checkbox"/> CLV <input type="checkbox"/> AOLV <input type="checkbox"/> OLV/PM <input type="checkbox"/> AOLV/PM <input type="checkbox"/> CLV/PM <input type="checkbox"/> EZOLV Sets a middle output frequency for the motor 2 V/f pattern.	Determined by E3-01 (0.0 - E3-04)	810
E3-08 (031E)	Motor 2 Mid Point A Voltage	<input type="checkbox"/> V/f <input type="checkbox"/> CL-V/f <input type="checkbox"/> OLV <input type="checkbox"/> CLV <input type="checkbox"/> AOLV <input type="checkbox"/> OLV/PM <input type="checkbox"/> AOLV/PM <input type="checkbox"/> CLV/PM <input type="checkbox"/> EZOLV Sets a middle output voltage for the motor 2 V/f pattern.	Determined by E3-01 (200 V Class: 0.0 - 255.0 V, 400 V Class: 0.0 - 510.0 V)	810
E3-09 (031F)	Motor 2 Minimum Output Frequency	<input type="checkbox"/> V/f <input type="checkbox"/> CL-V/f <input type="checkbox"/> OLV <input type="checkbox"/> CLV <input type="checkbox"/> AOLV <input type="checkbox"/> OLV/PM <input type="checkbox"/> AOLV/PM <input type="checkbox"/> CLV/PM <input type="checkbox"/> EZOLV Sets the minimum output frequency for the motor 2 V/f pattern.	Determined by E3-01 (0.0 - E3-04)	810
E3-10 (0320)	Motor 2 Minimum Output Voltage	<input type="checkbox"/> V/f <input type="checkbox"/> CL-V/f <input type="checkbox"/> OLV <input type="checkbox"/> CLV <input type="checkbox"/> AOLV <input type="checkbox"/> OLV/PM <input type="checkbox"/> AOLV/PM <input type="checkbox"/> CLV/PM <input type="checkbox"/> EZOLV Sets the minimum output voltage for the motor 2 V/f pattern.	Determined by E3-01 (200 V Class: 0.0 - 255.0 V, 400 V Class: 0.0 - 510.0 V)	810
E3-11 (0345) Expert	Motor 2 Mid Point B Frequency	<input type="checkbox"/> V/f <input type="checkbox"/> CL-V/f <input type="checkbox"/> OLV <input type="checkbox"/> CLV <input type="checkbox"/> AOLV <input type="checkbox"/> OLV/PM <input type="checkbox"/> AOLV/PM <input type="checkbox"/> CLV/PM <input type="checkbox"/> EZOLV Sets a middle output frequency for the motor 2 V/f pattern. Set this parameter to adjust the V/f pattern for the constant output range. Usually it is not necessary to change this setting.	0.0 Hz (0.0 - E3-04)	811

No. (Hex.)	Name	Description	Default (Range)	Ref.
E3-12 (0346) Expert	Motor 2 Mid Point B Voltage	<input type="checkbox"/> V/f <input type="checkbox"/> CL-V/f <input type="checkbox"/> OLV <input type="checkbox"/> CLV <input type="checkbox"/> AOLV <input type="checkbox"/> OLV/PM <input type="checkbox"/> AOLV/PM <input type="checkbox"/> CLV/PM <input type="checkbox"/> EZOLV Sets a middle output voltage for the motor 2 V/f pattern. Set this parameter to adjust the V/f pattern for the constant output range. Usually it is not necessary to change this setting.	0.0 V (200 V Class: 0.0 - 255.0 V, 400 V Class: 0.0 - 510.0 V)	811
E3-13 (0347) Expert	Motor 2 Base Voltage	<input type="checkbox"/> V/f <input type="checkbox"/> CL-V/f <input type="checkbox"/> OLV <input type="checkbox"/> CLV <input type="checkbox"/> AOLV <input type="checkbox"/> OLV/PM <input type="checkbox"/> AOLV/PM <input type="checkbox"/> CLV/PM <input type="checkbox"/> EZOLV Sets the base voltage for the motor 2 V/f pattern. Set this parameter to adjust the V/f pattern for the constant output range. Usually it is not necessary to change this setting.	0.0 V (200 V Class: 0.0 - 255.0 V, 400 V Class: 0.0 - 510.0 V)	811

#### ◆ E4: Motor 2 Parameters

No. (Hex.)	Name	Description	Default (Range)	Ref.
E4-01 (0321)	Motor 2 Rated Current	<input type="checkbox"/> V/f <input type="checkbox"/> CL-V/f <input type="checkbox"/> OLV <input type="checkbox"/> CLV <input type="checkbox"/> AOLV <input type="checkbox"/> OLV/PM <input type="checkbox"/> AOLV/PM <input type="checkbox"/> CLV/PM <input type="checkbox"/> EZOLV Sets the motor rated current for motor 2 in amps.	Determined by o2-04 and C6-01 (10% to 200% of the drive rated current)	811
E4-02 (0322)	Motor 2 Rated Slip	<input type="checkbox"/> V/f <input type="checkbox"/> CL-V/f <input type="checkbox"/> OLV <input type="checkbox"/> CLV <input type="checkbox"/> AOLV <input type="checkbox"/> OLV/PM <input type="checkbox"/> AOLV/PM <input type="checkbox"/> CLV/PM <input type="checkbox"/> EZOLV Sets the motor rated slip for motor 2.	Determined by o2-04 and C6-01 (0.000 - 20.000 Hz)	812
E4-03 (0323)	Motor 2 Rated No-Load Current	<input type="checkbox"/> V/f <input type="checkbox"/> CL-V/f <input type="checkbox"/> OLV <input type="checkbox"/> CLV <input type="checkbox"/> AOLV <input type="checkbox"/> OLV/PM <input type="checkbox"/> AOLV/PM <input type="checkbox"/> CLV/PM <input type="checkbox"/> EZOLV Sets the no-load current for motor 2 in amps when operating at the rated frequency and the no-load voltage.	Determined by o2-04 and C6-01 (0 to E4-01)	812
E4-04 (0324)	Motor 2 Motor Poles	<input type="checkbox"/> V/f <input type="checkbox"/> CL-V/f <input type="checkbox"/> OLV <input type="checkbox"/> CLV <input type="checkbox"/> AOLV <input type="checkbox"/> OLV/PM <input type="checkbox"/> AOLV/PM <input type="checkbox"/> CLV/PM <input type="checkbox"/> EZOLV Sets the number of poles for motor 2.	4 (2 - 120)	812
E4-05 (0325)	Motor 2 Line-to-Line Resistance	<input type="checkbox"/> V/f <input type="checkbox"/> CL-V/f <input type="checkbox"/> OLV <input type="checkbox"/> CLV <input type="checkbox"/> AOLV <input type="checkbox"/> OLV/PM <input type="checkbox"/> AOLV/PM <input type="checkbox"/> CLV/PM <input type="checkbox"/> EZOLV Sets the line-to-line resistance for the motor 2 stator windings.	Determined by o2-04 and C6-01 (0.000 - 65.000 Ω)	812
E4-06 (0326)	Motor 2 Leakage Inductance	<input type="checkbox"/> V/f <input type="checkbox"/> CL-V/f <input type="checkbox"/> OLV <input type="checkbox"/> CLV <input type="checkbox"/> AOLV <input type="checkbox"/> OLV/PM <input type="checkbox"/> AOLV/PM <input type="checkbox"/> CLV/PM <input type="checkbox"/> EZOLV Sets the voltage drop from motor 2 leakage inductance as a percentage of Motor Rated Voltage when motor 2 operates at the rated frequency and rated current.	Determined by o2-04, C6-01 (0.0 - 60.0%)	813
E4-07 (0343)	Motor 2 Saturation Coefficient 1	<input type="checkbox"/> V/f <input type="checkbox"/> CL-V/f <input type="checkbox"/> OLV <input type="checkbox"/> CLV <input type="checkbox"/> AOLV <input type="checkbox"/> OLV/PM <input type="checkbox"/> AOLV/PM <input type="checkbox"/> CLV/PM <input type="checkbox"/> EZOLV Sets the motor 2 iron-core saturation coefficient at 50% of the magnetic flux.	0.50 (0.00 - 0.50)	813
E4-08 (0344)	Motor 2 Saturation Coefficient 2	<input type="checkbox"/> V/f <input type="checkbox"/> CL-V/f <input type="checkbox"/> OLV <input type="checkbox"/> CLV <input type="checkbox"/> AOLV <input type="checkbox"/> OLV/PM <input type="checkbox"/> AOLV/PM <input type="checkbox"/> CLV/PM <input type="checkbox"/> EZOLV Sets the motor 2 iron-core saturation coefficient at 75% of the magnetic flux.	0.75 (E4-07 - 0.75)	813
E4-09 (033F) Expert	Motor 2 Mechanical Loss	<input type="checkbox"/> V/f <input type="checkbox"/> CL-V/f <input type="checkbox"/> OLV <input type="checkbox"/> CLV <input type="checkbox"/> AOLV <input type="checkbox"/> OLV/PM <input type="checkbox"/> AOLV/PM <input type="checkbox"/> CLV/PM <input type="checkbox"/> EZOLV Sets the mechanical loss of motor 2. Motor rated power (kW) is 100%. Usually it is not necessary to change this setting.	0.0% (0.0 - 10.0%)	813
E4-10 (0340)	Motor 2 Iron Loss	<input type="checkbox"/> V/f <input type="checkbox"/> CL-V/f <input type="checkbox"/> OLV <input type="checkbox"/> CLV <input type="checkbox"/> AOLV <input type="checkbox"/> OLV/PM <input type="checkbox"/> AOLV/PM <input type="checkbox"/> CLV/PM <input type="checkbox"/> EZOLV Sets the motor iron loss for motor 2.	Determined by o2-04 and C6-01 (0 - 65535 W)	813
E4-11 (0327)	Motor 2 Rated Power	<input type="checkbox"/> V/f <input type="checkbox"/> CL-V/f <input type="checkbox"/> OLV <input type="checkbox"/> CLV <input type="checkbox"/> AOLV <input type="checkbox"/> OLV/PM <input type="checkbox"/> AOLV/PM <input type="checkbox"/> CLV/PM <input type="checkbox"/> EZOLV Sets the motor 2 rated power in 0.01 kW increments (1 HP = 0.746 kW).	Determined by o2-04 and C6-01 (0.00 - 650.00 kW)	814



## ◆ E5: PM Motor Settings

No. (Hex.)	Name	Description	Default (Range)	Ref.
E5-01 (0329)	PM Motor Code Selection	V/f CL-V/f OLV CLV AOLV <b>OLV/PM</b> AOLV/PM CLV/PM EZOLV Sets the motor code for Yaskawa PM motors. The drive uses the motor code to set some parameters to their correct settings automatically.	Determined by A1-02, o2-04, and C6-01 (0000 - FFFF)	814
E5-02 (032A)	PM Motor Rated Power (kW)	V/f CL-V/f OLV CLV AOLV <b>OLV/PM</b> AOLV/PM CLV/PM EZOLV Sets the PM motor rated power.	Determined by E5-01 (0.10 - 650.00 kW)	814
E5-03 (032B)	PM Motor Rated Current (FLA)	V/f CL-V/f OLV CLV AOLV <b>OLV/PM</b> AOLV/PM CLV/PM EZOLV Sets the PM motor rated current (FLA).	Determined by E5-01 (10% to 200% of the drive rated current)	277
E5-04 (032C)	PM Motor Pole Count	V/f CL-V/f OLV CLV AOLV <b>OLV/PM</b> AOLV/PM CLV/PM EZOLV Sets the number of PM motor poles. <b>Note:</b> • When A1-02 = 7 [Control Method Selection = CLV/PM], the maximum value is 120. • When A1-02 = 5, 6 or 8 [OLV/PM, AOLV/PM or EZOLV], the maximum value is 48.	Determined by E5-01 (2 - 120)	815
E5-05 (032D)	PM Motor Resistance (ohms/phase)	V/f CL-V/f OLV CLV AOLV <b>OLV/PM</b> AOLV/PM CLV/PM EZOLV Sets the resistance per phase of the PM motors. Set 50% of the line-to-line resistance.	Determined by E5-01 (0.000 - 65.000 Ω)	815
E5-06 (032E)	PM d-axis Inductance (mH/phase)	V/f CL-V/f OLV CLV AOLV <b>OLV/PM</b> AOLV/PM CLV/PM EZOLV Sets the PM motor d-axis inductance.	Determined by E5-01 (0.00 - 300.00 mH)	815
E5-07 (032F)	PM q-axis Inductance (mH/phase)	V/f CL-V/f OLV CLV AOLV <b>OLV/PM</b> AOLV/PM CLV/PM EZOLV Sets the PM motor q-axis inductance.	Determined by E5-01 (0.00 - 600.00 mH)	816
E5-09 (0331)	PM Back-EMF V <sub>peak</sub> (mV/(rad/s))	V/f CL-V/f OLV CLV AOLV <b>OLV/PM</b> AOLV/PM CLV/PM EZOLV Sets the peak value of PM motor induced voltage.	Determined by E5-01 (0.0 - 2000.0 mV/(rad/s))	816
E5-11 (0333)	Encoder Z-Pulse Offset	V/f CL-V/f OLV CLV AOLV <b>OLV/PM</b> AOLV/PM CLV/PM EZOLV Sets the encoder Z-pulse offset.	0.0 degrees (-180.0 - +180.0 degrees)	816
E5-24 (0353)	PM Back-EMF L-L Vrms (mV/rpm)	V/f CL-V/f OLV CLV AOLV <b>OLV/PM</b> AOLV/PM CLV/PM EZOLV Sets the RMS value for PM motor line voltage.	Determined by E5-01 (0.0 - 6500.0 mV/min <sup>-1</sup> )	816
E5-25 (035E) Expert	Polarity Estimation Timeout	V/f CL-V/f OLV CLV AOLV <b>OLV/PM</b> AOLV/PM CLV/PM EZOLV Sets the function that switches polarity for initial polarity estimation. Usually it is not necessary to change this setting. 0 : Disabled 1 : Enabled	0 (0, 1)	817

## ◆ E9: Motor Setting

No. (Hex.)	Name	Description	Default (Range)	Ref.
E9-01 (11E4)	Motor Type Selection	<div style="display: flex; justify-content: space-between; font-size: 0.8em; margin-bottom: 5px;"> <span>V/f</span> <span>CL-V/f</span> <span>OLV</span> <span>CLV</span> <span>AOLV</span> <span>OLV/PM</span> <span>AOLV/PM</span> <span>CLV/PM</span> <span style="background-color: #ccc; border: 1px solid #000; padding: 2px;">EZOLV</span> </div> Sets the type of motor. 0 : Induction (IM) 1 : Permanent Magnet (PM) 2 : Synchronous Reluctance (SynRM)	0 (0 - 2)	817
E9-02 (11E5)	Maximum Speed	<div style="display: flex; justify-content: space-between; font-size: 0.8em; margin-bottom: 5px;"> <span>V/f</span> <span>CL-V/f</span> <span>OLV</span> <span>CLV</span> <span>AOLV</span> <span>OLV/PM</span> <span>AOLV/PM</span> <span>CLV/PM</span> <span style="background-color: #ccc; border: 1px solid #000; padding: 2px;">EZOLV</span> </div> Sets the maximum speed of the motor.	Determined by E9-01 (40.0 - 120.0 Hz)	817
E9-03 (11E6)	Rated Speed	<div style="display: flex; justify-content: space-between; font-size: 0.8em; margin-bottom: 5px;"> <span>V/f</span> <span>CL-V/f</span> <span>OLV</span> <span>CLV</span> <span>AOLV</span> <span>OLV/PM</span> <span>AOLV/PM</span> <span>CLV/PM</span> <span style="background-color: #ccc; border: 1px solid #000; padding: 2px;">EZOLV</span> </div> Sets the rated rotation speed of the motor.	Determined by E9-01 (100 - 7200 min <sup>-1</sup> )	817
E9-04 (11E7)	Base Frequency	<div style="display: flex; justify-content: space-between; font-size: 0.8em; margin-bottom: 5px;"> <span>V/f</span> <span>CL-V/f</span> <span>OLV</span> <span>CLV</span> <span>AOLV</span> <span>OLV/PM</span> <span>AOLV/PM</span> <span>CLV/PM</span> <span style="background-color: #ccc; border: 1px solid #000; padding: 2px;">EZOLV</span> </div> Sets the rated frequency of the motor.	Determined by E9-01 (40.0 - 120.0 Hz)	817
E9-05 (11E8)	Base Voltage	<div style="display: flex; justify-content: space-between; font-size: 0.8em; margin-bottom: 5px;"> <span>V/f</span> <span>CL-V/f</span> <span>OLV</span> <span>CLV</span> <span>AOLV</span> <span>OLV/PM</span> <span>AOLV/PM</span> <span>CLV/PM</span> <span style="background-color: #ccc; border: 1px solid #000; padding: 2px;">EZOLV</span> </div> Sets the rated voltage of the motor.	Determined by E9-01  (200 V Class: 0.0 to 255.0 V, 400 V Class: 0.0 to 510.0 V)	818
E9-06 (11E9)	Motor Rated Current (FLA)	<div style="display: flex; justify-content: space-between; font-size: 0.8em; margin-bottom: 5px;"> <span>V/f</span> <span>CL-V/f</span> <span>OLV</span> <span>CLV</span> <span>AOLV</span> <span>OLV/PM</span> <span>AOLV/PM</span> <span>CLV/PM</span> <span style="background-color: #ccc; border: 1px solid #000; padding: 2px;">EZOLV</span> </div> Sets the motor rated current in amps.	Determined by E9-01 and o2-04 (10% to 200% of the drive rated current)	277
E9-07 (11EA)	Motor Rated Power (kW)	<div style="display: flex; justify-content: space-between; font-size: 0.8em; margin-bottom: 5px;"> <span>V/f</span> <span>CL-V/f</span> <span>OLV</span> <span>CLV</span> <span>AOLV</span> <span>OLV/PM</span> <span>AOLV/PM</span> <span>CLV/PM</span> <span style="background-color: #ccc; border: 1px solid #000; padding: 2px;">EZOLV</span> </div> Sets the motor rated power in 0.01 kW increments (1 HP = 0.746 kW).	Determined by E9-02 and o2-04 (0.00 - 650.00 kW)	818
E9-08 (11EB)	Motor Pole Count	<div style="display: flex; justify-content: space-between; font-size: 0.8em; margin-bottom: 5px;"> <span>V/f</span> <span>CL-V/f</span> <span>OLV</span> <span>CLV</span> <span>AOLV</span> <span>OLV/PM</span> <span>AOLV/PM</span> <span>CLV/PM</span> <span style="background-color: #ccc; border: 1px solid #000; padding: 2px;">EZOLV</span> </div> Sets the number of motor poles.	4 (2 - 120)	818
E9-09 (11EC)	Motor Rated Slip	<div style="display: flex; justify-content: space-between; font-size: 0.8em; margin-bottom: 5px;"> <span>V/f</span> <span>CL-V/f</span> <span>OLV</span> <span>CLV</span> <span>AOLV</span> <span>OLV/PM</span> <span>AOLV/PM</span> <span>CLV/PM</span> <span style="background-color: #ccc; border: 1px solid #000; padding: 2px;">EZOLV</span> </div> Sets the motor rated slip.	0.0 Hz (0.0 - 20.0 Hz)	818
E9-10 (11ED)	Motor Line-to-Line Resistance	<div style="display: flex; justify-content: space-between; font-size: 0.8em; margin-bottom: 5px;"> <span>V/f</span> <span>CL-V/f</span> <span>OLV</span> <span>CLV</span> <span>AOLV</span> <span>OLV/PM</span> <span>AOLV/PM</span> <span>CLV/PM</span> <span style="background-color: #ccc; border: 1px solid #000; padding: 2px;">EZOLV</span> </div> Sets the line-to-line resistance for the motor stator windings.	Determined by o2-04 (0.000 - 65.000 Ω)	819

## 10.9 F: Options

### ◆ F1: PG Option Setup (Encoder)

No. (Hex.)	Name	Description	Default (Range)	Ref.
F1-01 (0380)	Encoder 1 Pulse Count (PPR)	<input type="checkbox"/> V/f <input type="checkbox"/> CL-V/f <input type="checkbox"/> OLV <input type="checkbox"/> CLV <input type="checkbox"/> AOLV <input type="checkbox"/> OLV/PM <input type="checkbox"/> AOLV/PM <input type="checkbox"/> CLV/PM <input type="checkbox"/> EZOLV Sets the number of output pulses for each motor revolution.	1024 ppr (1 - 60000 ppr)	821
F1-02 (0381)	Encoder Signal Loss Detect Sel	<input type="checkbox"/> V/f <input type="checkbox"/> CL-V/f <input type="checkbox"/> OLV <input type="checkbox"/> CLV <input type="checkbox"/> AOLV <input type="checkbox"/> OLV/PM <input type="checkbox"/> AOLV/PM <input type="checkbox"/> CLV/PM <input type="checkbox"/> EZOLV Sets the method to stop the motor or let the motor continue operating when the drive detects a <i>PGo</i> [Encoder (PG) Feedback Loss]. 0 : Ramp to Stop 1 : Coast to Stop 2 : Fast Stop (Use C1-09) 3 : Alarm Only 4 : No Alarm Display	1 (0 - 4)	821
F1-03 (0382)	Overspeed Detection Selection	<input type="checkbox"/> V/f <input type="checkbox"/> CL-V/f <input type="checkbox"/> OLV <input type="checkbox"/> CLV <input type="checkbox"/> AOLV <input type="checkbox"/> OLV/PM <input type="checkbox"/> AOLV/PM <input type="checkbox"/> CLV/PM <input type="checkbox"/> EZOLV Sets the method to stop the motor or let the motor continue operating when the drive detects a <i>oS</i> [Overspeed]. 0 : Ramp to Stop 1 : Coast to Stop 2 : Fast Stop (Use C1-09) 3 : Alarm Only 4 : No Alarm Display	1 (0 - 3)	821
F1-04 (0383)	Speed Deviation Detection Select	<input type="checkbox"/> V/f <input type="checkbox"/> CL-V/f <input type="checkbox"/> OLV <input type="checkbox"/> CLV <input type="checkbox"/> AOLV <input type="checkbox"/> OLV/PM <input type="checkbox"/> AOLV/PM <input type="checkbox"/> CLV/PM <input type="checkbox"/> EZOLV Sets the method to stop the motor or let the motor continue operating when the drive detects a <i>dEv</i> [Speed Deviation]. 0 : Ramp to Stop 1 : Coast to Stop 2 : Fast Stop (Use C1-09) 3 : Alarm Only	3 (0 - 3)	822
F1-05 (0384)	Encoder 1 Rotation Selection	<input type="checkbox"/> V/f <input type="checkbox"/> CL-V/f <input type="checkbox"/> OLV <input type="checkbox"/> CLV <input type="checkbox"/> AOLV <input type="checkbox"/> OLV/PM <input type="checkbox"/> AOLV/PM <input type="checkbox"/> CLV/PM <input type="checkbox"/> EZOLV Sets the output sequence for the A and B pulses from the encoder, assuming that the motor is operating in the forward direction. 0 : Pulse A leads in FWD Direction 1 : Pulse B leads in FWD Direction	Determined by A1-02 (0, 1)	822
F1-06 (0385)	Encoder 1 Pulse Monitor Scaling	<input type="checkbox"/> V/f <input type="checkbox"/> CL-V/f <input type="checkbox"/> OLV <input type="checkbox"/> CLV <input type="checkbox"/> AOLV <input type="checkbox"/> OLV/PM <input type="checkbox"/> AOLV/PM <input type="checkbox"/> CLV/PM <input type="checkbox"/> EZOLV Sets the ratio between the pulse input and the pulse output of the encoder as a 3-digit number. The first digit is the numerator and the second and third digits set the denominator. The dividing ratio = $(1 + x)/yz$ when the setting value is a 3-digit value (xyz).	001 (001 - 032, 102 - 132 (1 - 1/32))	822
F1-08 (0387)	Overspeed Detection Level	<input type="checkbox"/> V/f <input type="checkbox"/> CL-V/f <input type="checkbox"/> OLV <input type="checkbox"/> CLV <input type="checkbox"/> AOLV <input type="checkbox"/> OLV/PM <input type="checkbox"/> AOLV/PM <input type="checkbox"/> CLV/PM <input type="checkbox"/> EZOLV Sets the detection level of <i>oS</i> [Overspeed] as a percentage when the maximum output frequency is 100%.	115% (0 - 120%)	823
F1-09 (0388)	Overspeed Detection Delay Time	<input type="checkbox"/> V/f <input type="checkbox"/> CL-V/f <input type="checkbox"/> OLV <input type="checkbox"/> CLV <input type="checkbox"/> AOLV <input type="checkbox"/> OLV/PM <input type="checkbox"/> AOLV/PM <input type="checkbox"/> CLV/PM <input type="checkbox"/> EZOLV Sets the length of time that the speed feedback must be more than the <i>F1-08</i> level to cause an <i>oS</i> [Overspeed].	Determined by A1-02 (0.0 - 2.0 s)	823
F1-10 (0389)	Speed Deviation Detection Level	<input type="checkbox"/> V/f <input type="checkbox"/> CL-V/f <input type="checkbox"/> OLV <input type="checkbox"/> CLV <input type="checkbox"/> AOLV <input type="checkbox"/> OLV/PM <input type="checkbox"/> AOLV/PM <input type="checkbox"/> CLV/PM <input type="checkbox"/> EZOLV Sets the detection level of <i>dEv</i> [Speed Deviation] as a percentage when the maximum output frequency is 100%.	10% (0 - 50%)	823
F1-11 (038A)	Speed Deviation Detect DelayTime	<input type="checkbox"/> V/f <input type="checkbox"/> CL-V/f <input type="checkbox"/> OLV <input type="checkbox"/> CLV <input type="checkbox"/> AOLV <input type="checkbox"/> OLV/PM <input type="checkbox"/> AOLV/PM <input type="checkbox"/> CLV/PM <input type="checkbox"/> EZOLV Sets the length of time that the difference between the frequency reference and speed feedback must be more than the level in <i>F1-10</i> to cause a <i>dEv</i> [Speed Deviation].	0.5 s (0.0 - 10.0 s)	823
F1-12 (038B)	Encoder 1 Gear Teeth 1	<input type="checkbox"/> V/f <input type="checkbox"/> CL-V/f <input type="checkbox"/> OLV <input type="checkbox"/> CLV <input type="checkbox"/> AOLV <input type="checkbox"/> OLV/PM <input type="checkbox"/> AOLV/PM <input type="checkbox"/> CLV/PM <input type="checkbox"/> EZOLV Sets the number of gear teeth on the motor side. This parameter and <i>F1-13</i> [Encoder 1 Gear Teeth 2] set the gear ratio between the motor and encoder.	0 (0 - 1000)	823

## 10.9 F: Options

No. (Hex.)	Name	Description	Default (Range)	Ref.
F1-13 (038C)	Encoder 1 Gear Teeth 2	<p>V/f <input type="checkbox"/> CL-V/f <input type="checkbox"/> OLV <input type="checkbox"/> CLV <input type="checkbox"/> AOLV <input type="checkbox"/> OLV/PM <input type="checkbox"/> AOLV/PM <input type="checkbox"/> CLV/PM <input type="checkbox"/> EZOLV <input type="checkbox"/></p> <p>Sets the number of gear teeth on the load side. This parameter and F1-12 [Encoder 1 Gear Teeth 1] set the gear ratio between the motor and encoder.</p>	0 (0 - 1000)	824
F1-14 (038D)	Encoder Open-Circuit Detect Time	<p>V/f <input type="checkbox"/> CL-V/f <input type="checkbox"/> OLV <input type="checkbox"/> CLV <input type="checkbox"/> AOLV <input type="checkbox"/> OLV/PM <input type="checkbox"/> AOLV/PM <input type="checkbox"/> CLV/PM <input type="checkbox"/> EZOLV <input type="checkbox"/></p> <p>Sets the length of time that the drive must not receive a pulse signal to cause a PGo [Encoder (PG) Feedback Loss].</p> <p><b>Note:</b> Motor speed and load conditions can cause ov [Overvoltage] and oC [Overcurrent] faults.</p>	2.0 s (0.0 - 10.0 s)	824
F1-18 (03AD)	Deviation 3 Detection Selection	<p>V/f <input type="checkbox"/> CL-V/f <input type="checkbox"/> OLV <input type="checkbox"/> CLV <input type="checkbox"/> AOLV <input type="checkbox"/> OLV/PM <input type="checkbox"/> AOLV/PM <input type="checkbox"/> CLV/PM <input type="checkbox"/> EZOLV <input type="checkbox"/></p> <p>Sets the number of rotations necessary to detect conditions that invert the torque reference and rate of acceleration and cause dv3 [Inversion Detection].</p>	10 (0 - 10)	824
F1-19 (03AE)	Deviation 4 Detection Selection	<p>V/f <input type="checkbox"/> CL-V/f <input type="checkbox"/> OLV <input type="checkbox"/> CLV <input type="checkbox"/> AOLV <input type="checkbox"/> OLV/PM <input type="checkbox"/> AOLV/PM <input type="checkbox"/> CLV/PM <input type="checkbox"/> EZOLV <input type="checkbox"/></p> <p>Sets the number of pulses necessary to cause dv4 [Inversion Prevention Detection].</p>	128 (0 - 5000)	824
F1-20 (03B4)	Encoder 1 PCB Disconnect Detect	<p>V/f <input type="checkbox"/> CL-V/f <input type="checkbox"/> OLV <input type="checkbox"/> CLV <input type="checkbox"/> AOLV <input type="checkbox"/> OLV/PM <input type="checkbox"/> AOLV/PM <input type="checkbox"/> CLV/PM <input type="checkbox"/> EZOLV <input type="checkbox"/></p> <p>Sets the function that enables and disables detection of a disconnected encoder connection cable to cause PGoH [Encoder (PG) Hardware Fault].</p> <p>0 : Disabled 1 : Enabled</p>	1 (0, 1)	825
F1-21 (03BC)	Encoder 1 Signal Selection	<p>V/f <input type="checkbox"/> CL-V/f <input type="checkbox"/> OLV <input type="checkbox"/> CLV <input type="checkbox"/> AOLV <input type="checkbox"/> OLV/PM <input type="checkbox"/> AOLV/PM <input type="checkbox"/> CLV/PM <input type="checkbox"/> EZOLV <input type="checkbox"/></p> <p>Sets the number of channels for the signal to the encoder option card.</p> <p>0 : A Pulse Detection 1 : AB Pulse Detection</p>	0 (0, 1)	825
F1-30 (03AA)	Motor 2 Encoder PCB Port Select	<p>V/f <input type="checkbox"/> CL-V/f <input type="checkbox"/> OLV <input type="checkbox"/> CLV <input type="checkbox"/> AOLV <input type="checkbox"/> OLV/PM <input type="checkbox"/> AOLV/PM <input type="checkbox"/> CLV/PM <input type="checkbox"/> EZOLV <input type="checkbox"/></p> <p>Sets the drive port to install the motor 2 encoder option card.</p> <p>0 : CN5-C 1 : CN5-B</p>	1 (0, 1)	825
F1-31 (03B0)	Encoder 2 Pulse Count (PPR)	<p>V/f <input type="checkbox"/> CL-V/f <input type="checkbox"/> OLV <input type="checkbox"/> CLV <input type="checkbox"/> AOLV <input type="checkbox"/> OLV/PM <input type="checkbox"/> AOLV/PM <input type="checkbox"/> CLV/PM <input type="checkbox"/> EZOLV <input type="checkbox"/></p> <p>Sets the number of output pulses for each motor revolution for motor 2.</p>	1024 ppr (1 - 60000 ppr)	825
F1-32 (03B1)	Encoder 2 Rotation Selection	<p>V/f <input type="checkbox"/> CL-V/f <input type="checkbox"/> OLV <input type="checkbox"/> CLV <input type="checkbox"/> AOLV <input type="checkbox"/> OLV/PM <input type="checkbox"/> AOLV/PM <input type="checkbox"/> CLV/PM <input type="checkbox"/> EZOLV <input type="checkbox"/></p> <p>Sets the output sequence for the A and B pulses from the encoder for motor 2. This parameter assumes that the motor is operating in the forward direction.</p> <p>0 : Pulse A leads in FWD Direction 1 : Pulse B leads in FWD Direction</p>	0 (0, 1)	825
F1-33 (03B2)	Encoder 2 Gear Teeth 1	<p>V/f <input type="checkbox"/> CL-V/f <input type="checkbox"/> OLV <input type="checkbox"/> CLV <input type="checkbox"/> AOLV <input type="checkbox"/> OLV/PM <input type="checkbox"/> AOLV/PM <input type="checkbox"/> CLV/PM <input type="checkbox"/> EZOLV <input type="checkbox"/></p> <p>Sets the number of gear teeth on the motor side for motor 2. This parameter and F1-34 [Encoder 2 Gear Teeth 2] set the gear ratio between the motor and encoder.</p>	0 (0 - 1000)	825
F1-34 (03B3)	Encoder 2 Gear Teeth 2	<p>V/f <input type="checkbox"/> CL-V/f <input type="checkbox"/> OLV <input type="checkbox"/> CLV <input type="checkbox"/> AOLV <input type="checkbox"/> OLV/PM <input type="checkbox"/> AOLV/PM <input type="checkbox"/> CLV/PM <input type="checkbox"/> EZOLV <input type="checkbox"/></p> <p>Sets the number of gear teeth on the load side for motor 2. This parameter and F1-33 [Encoder 2 Gear Teeth 1] set the gear ratio between the motor and encoder.</p>	0 (0 - 1000)	826
F1-35 (03BE)	Encoder 2 Pulse Monitor Scaling	<p>V/f <input type="checkbox"/> CL-V/f <input type="checkbox"/> OLV <input type="checkbox"/> CLV <input type="checkbox"/> AOLV <input type="checkbox"/> OLV/PM <input type="checkbox"/> AOLV/PM <input type="checkbox"/> CLV/PM <input type="checkbox"/> EZOLV <input type="checkbox"/></p> <p>Sets the ratio between the pulse input and the pulse output of the encoder as a 3-digit number for motor 2. The first digit is the numerator and the second and third digits set the denominator. The dividing ratio = (1 + x)/yz when the setting value is a 3-digit value (xyz).</p>	001 (001 - 032, 102 - 132 (1 - 1/32))	826
F1-36 (03B5)	Encoder 2 PCB Disconnect Detect	<p>V/f <input type="checkbox"/> CL-V/f <input type="checkbox"/> OLV <input type="checkbox"/> CLV <input type="checkbox"/> AOLV <input type="checkbox"/> OLV/PM <input type="checkbox"/> AOLV/PM <input type="checkbox"/> CLV/PM <input type="checkbox"/> EZOLV <input type="checkbox"/></p> <p>Sets the function that enables and disables detection of a disconnected encoder connection cable to cause PGoH [Encoder (PG) Hardware Fault] for motor 2.</p> <p>0 : Disabled 1 : Enabled</p>	1 (0, 1)	826

No. (Hex.)	Name	Description	Default (Range)	Ref.
F1-37 (03BD)	Encoder 2 Signal Selection	<p>V/f <input type="checkbox"/> CL-V/f <input checked="" type="checkbox"/> OLV <input type="checkbox"/> CLV <input type="checkbox"/> AOLV <input type="checkbox"/> OLV/PM <input type="checkbox"/> AOLV/PM <input type="checkbox"/> CLV/PM <input type="checkbox"/> EZOLV</p> <p>Sets the number of channels for the signal to the encoder option card for motor 2. 0 : A Pulse Detection 1 : AB Pulse Detection</p>	0 (0, 1)	826
F1-50 (03D2)	PG-F3 Option Encoder Type	<p>V/f <input type="checkbox"/> CL-V/f <input type="checkbox"/> OLV <input type="checkbox"/> CLV <input type="checkbox"/> AOLV <input type="checkbox"/> OLV/PM <input type="checkbox"/> AOLV/PM <input checked="" type="checkbox"/> CLV/PM <input type="checkbox"/> EZOLV</p> <p>Sets the type of encoder connected to the PG-F3 option. 0 : EnDat Sin/Cos 1 : EnDat Serial Only 2 : HIPERFACE</p>	0 (0 - 2)	827
F1-51 (03D3)	PG-F3 PGoH Detection Level	<p>V/f <input type="checkbox"/> CL-V/f <input type="checkbox"/> OLV <input type="checkbox"/> CLV <input type="checkbox"/> AOLV <input type="checkbox"/> OLV/PM <input type="checkbox"/> AOLV/PM <input checked="" type="checkbox"/> CLV/PM <input type="checkbox"/> EZOLV</p> <p>The drive will detect PGoH [<i>Encoder (PG) Hardware Fault</i>] when the value of this parameter is less than the value of <math>\sqrt{\sin^2\theta + \cos^2\theta}</math>. <b>Note:</b> Set F1-20 = 1 [<i>Encoder 1 PCB Disconnect Detect = Enabled</i>] to enable this function.</p>	80% (1 - 100%)	827
F1-52 (03D4)	Serial Encoder Comm Speed	<p>V/f <input type="checkbox"/> CL-V/f <input type="checkbox"/> OLV <input type="checkbox"/> CLV <input type="checkbox"/> AOLV <input type="checkbox"/> OLV/PM <input type="checkbox"/> AOLV/PM <input checked="" type="checkbox"/> CLV/PM <input type="checkbox"/> EZOLV</p> <p>Sets the communication speed between the PG-F3 option and the serial encoder. 0 : 1M/9600bps 1 : 500k/19200bps 2 : 1M/38400bps</p>	0 (0 - 2)	827

## ◆ F2: Analog Input Option

No. (Hex.)	Name	Description	Default (Range)	Ref.
F2-01 (038F)	Analog Input Function Selection	<p>V/f <input type="checkbox"/> CL-V/f <input type="checkbox"/> OLV <input type="checkbox"/> CLV <input type="checkbox"/> AOLV <input type="checkbox"/> OLV/PM <input type="checkbox"/> AOLV/PM <input type="checkbox"/> CLV/PM <input type="checkbox"/> EZOLV</p> <p>Sets the input method for the analog reference used with AI-A3. 0 : 3 Independent Channels 1 : 3 Channels Added Together</p>	0 (0, 1)	827
F2-02 (0368) RUN	Analog Input Option Card Gain	<p>V/f <input type="checkbox"/> CL-V/f <input type="checkbox"/> OLV <input type="checkbox"/> CLV <input type="checkbox"/> AOLV <input type="checkbox"/> OLV/PM <input type="checkbox"/> AOLV/PM <input type="checkbox"/> CLV/PM <input type="checkbox"/> EZOLV</p> <p>Sets the analog reference gain as a percentage when the maximum output frequency is 100%. <b>Note:</b> Set F2-01 = 1 [<i>Analog Input Function Selection = 3 Channels Added Together</i>] to enable this function.</p>	100.0% (-999.9 - +999.9%)	829
F2-03 (0369) RUN	Analog Input Option Card Bias	<p>V/f <input type="checkbox"/> CL-V/f <input type="checkbox"/> OLV <input type="checkbox"/> CLV <input type="checkbox"/> AOLV <input type="checkbox"/> OLV/PM <input type="checkbox"/> AOLV/PM <input type="checkbox"/> CLV/PM <input type="checkbox"/> EZOLV</p> <p>Sets the analog reference bias as a percentage when the maximum output frequency is 100%. <b>Note:</b> Set F2-01 = 1 [<i>Analog Input Function Selection = 3 Channels Added Together</i>] to enable this function.</p>	0.0% (-999.9 - +999.9%)	829

### ◆ F3: Digital Input Option

No. (Hex.)	Name	Description	Default (Range)	Ref.
F3-01 (0390)	Digital Input Function Selection	<p><b>V/f</b> <b>CL-V/f</b> <b>OLV</b> <b>CLV</b> <b>AOLV</b> <b>OLV/PM</b> <b>AOLV/PM</b> <b>CLV/PM</b> <b>EZOLV</b></p> <p>Sets the data format of digital input signals. Set <i>o1-03</i> = 0 or 1 [<i>Frequency Display Unit Selection</i> = 0.01 Hz or 0.01% (100% = <i>E1-04</i>)] to enable this function.</p> <p><b>Note:</b> The input signal type is BCD when <i>o1-03</i> = 2 or 3 [<i>Revolutions Per Minute (RPM)</i> or <i>User Units (o1-10 &amp; o1-11)</i>]. The <i>o1-03</i> value sets the setting units.</p> <p>0 : BCD, 1% units 1 : BCD, 0.1% units 2 : BCD, 0.01% units 3 : BCD, 1 Hz units 4 : BCD, 0.1 Hz units 5 : BCD, 0.01 Hz units 6 : BCD (5-digit), 0.01 Hz 7 : Binary input 8 : Multi-Function Digital Input</p>	0 (0 - 8)	830
F3-03 (03B9)	Digital Input Data Length Select	<p><b>V/f</b> <b>CL-V/f</b> <b>OLV</b> <b>CLV</b> <b>AOLV</b> <b>OLV/PM</b> <b>AOLV/PM</b> <b>CLV/PM</b> <b>EZOLV</b></p> <p>Sets the number of bits to set the frequency reference with <i>DI-A3</i>.</p> <p>0 : 8-bit 1 : 12-bit 2 : 16-bit</p>	2 (0 - 2)	830
F3-10 (0BE3) Expert	Terminal D0 Function Selection	<p><b>V/f</b> <b>CL-V/f</b> <b>OLV</b> <b>CLV</b> <b>AOLV</b> <b>OLV/PM</b> <b>AOLV/PM</b> <b>CLV/PM</b> <b>EZOLV</b></p> <p>Sets the function for terminal D0 of the DI-A3 when <i>F3-01</i> = 8 [<i>Digital Input Function Selection</i> = Multi-Function Digital Input].</p>	F (1 - 19F)	831
F3-11 (0BE4) Expert	Terminal D1 Function Selection	<p><b>V/f</b> <b>CL-V/f</b> <b>OLV</b> <b>CLV</b> <b>AOLV</b> <b>OLV/PM</b> <b>AOLV/PM</b> <b>CLV/PM</b> <b>EZOLV</b></p> <p>Sets the function for terminal D1 of the DI-A3 when <i>F3-01</i> = 8 [<i>Digital Input Function Selection</i> = Multi-Function Digital Input].</p>	F (1 - 19F)	832
F3-12 (0BE5) Expert	Terminal D2 Function Selection	<p><b>V/f</b> <b>CL-V/f</b> <b>OLV</b> <b>CLV</b> <b>AOLV</b> <b>OLV/PM</b> <b>AOLV/PM</b> <b>CLV/PM</b> <b>EZOLV</b></p> <p>Sets the function for terminal D2 of the DI-A3 when <i>F3-01</i> = 8 [<i>Digital Input Function Selection</i> = Multi-Function Digital Input].</p>	F (1 - 19F)	832
F3-13 (0BE6) Expert	Terminal D3 Function Selection	<p><b>V/f</b> <b>CL-V/f</b> <b>OLV</b> <b>CLV</b> <b>AOLV</b> <b>OLV/PM</b> <b>AOLV/PM</b> <b>CLV/PM</b> <b>EZOLV</b></p> <p>Sets the function for terminal D3 of the DI-A3 when <i>F3-01</i> = 8 [<i>Digital Input Function Selection</i> = Multi-Function Digital Input].</p>	F (1 - 19F)	832
F3-14 (0BE7) Expert	Terminal D4 Function Selection	<p><b>V/f</b> <b>CL-V/f</b> <b>OLV</b> <b>CLV</b> <b>AOLV</b> <b>OLV/PM</b> <b>AOLV/PM</b> <b>CLV/PM</b> <b>EZOLV</b></p> <p>Sets the function for terminal D4 of the DI-A3 when <i>F3-01</i> = 8 [<i>Digital Input Function Selection</i> = Multi-Function Digital Input].</p>	F (1 - 19F)	832
F3-15 (0BE8) Expert	Terminal D5 Function Selection	<p><b>V/f</b> <b>CL-V/f</b> <b>OLV</b> <b>CLV</b> <b>AOLV</b> <b>OLV/PM</b> <b>AOLV/PM</b> <b>CLV/PM</b> <b>EZOLV</b></p> <p>Sets the function for terminal D5 of the DI-A3 when <i>F3-01</i> = 8 [<i>Digital Input Function Selection</i> = Multi-Function Digital Input].</p>	F (1 - 19F)	832
F3-16 (0BE9) Expert	Terminal D6 Function Selection	<p><b>V/f</b> <b>CL-V/f</b> <b>OLV</b> <b>CLV</b> <b>AOLV</b> <b>OLV/PM</b> <b>AOLV/PM</b> <b>CLV/PM</b> <b>EZOLV</b></p> <p>Sets the function for terminal D6 of the DI-A3 when <i>F3-01</i> = 8 [<i>Digital Input Function Selection</i> = Multi-Function Digital Input].</p>	F (1 - 19F)	832
F3-17 (0BEA) Expert	Terminal D7 Function Selection	<p><b>V/f</b> <b>CL-V/f</b> <b>OLV</b> <b>CLV</b> <b>AOLV</b> <b>OLV/PM</b> <b>AOLV/PM</b> <b>CLV/PM</b> <b>EZOLV</b></p> <p>Sets the function for terminal D7 of the DI-A3 when <i>F3-01</i> = 8 [<i>Digital Input Function Selection</i> = Multi-Function Digital Input].</p>	F (1 - 19F)	832
F3-18 (0BEB) Expert	Terminal D8 Function Selection	<p><b>V/f</b> <b>CL-V/f</b> <b>OLV</b> <b>CLV</b> <b>AOLV</b> <b>OLV/PM</b> <b>AOLV/PM</b> <b>CLV/PM</b> <b>EZOLV</b></p> <p>Sets the function for terminal D8 of the DI-A3 when <i>F3-01</i> = 8 [<i>Digital Input Function Selection</i> = Multi-Function Digital Input].</p>	F (1 - 19F)	833
F3-19 (0BEC) Expert	Terminal D9 Function Selection	<p><b>V/f</b> <b>CL-V/f</b> <b>OLV</b> <b>CLV</b> <b>AOLV</b> <b>OLV/PM</b> <b>AOLV/PM</b> <b>CLV/PM</b> <b>EZOLV</b></p> <p>Sets the function for terminal D9 of the DI-A3 when <i>F3-01</i> = 8 [<i>Digital Input Function Selection</i> = Multi-Function Digital Input].</p>	F (1 - 19F)	833

No. (Hex.)	Name	Description	Default (Range)	Ref.
F3-20 (0BED) Expert	Terminal DA Function Selection	<b>V/f</b> <b>CL-V/f</b> <b>OLV</b> <b>CLV</b> <b>AOLV</b> <b>OLV/PM</b> <b>AOLV/PM</b> <b>CLV/PM</b> <b>EZOLV</b> Sets the function for terminal DA of the DI-A3 when $F3-01 = 8$ [Digital Input Function Selection = Multi-Function Digital Input].	F (1 - 19F)	833
F3-21 (0BEE) Expert	Terminal DB Function Selection	<b>V/f</b> <b>CL-V/f</b> <b>OLV</b> <b>CLV</b> <b>AOLV</b> <b>OLV/PM</b> <b>AOLV/PM</b> <b>CLV/PM</b> <b>EZOLV</b> Sets the function for terminal DB of the DI-A3 when $F3-01 = 8$ [Digital Input Function Selection = Multi-Function Digital Input].	F (1 - 19F)	833
F3-22 (0BEF) Expert	Terminal DC Function Selection	<b>V/f</b> <b>CL-V/f</b> <b>OLV</b> <b>CLV</b> <b>AOLV</b> <b>OLV/PM</b> <b>AOLV/PM</b> <b>CLV/PM</b> <b>EZOLV</b> Sets the function for terminal DC of the DI-A3 when $F3-01 = 8$ [Digital Input Function Selection = Multi-Function Digital Input].	F (1 - 19F)	833
F3-23 (0BF0) Expert	Terminal DD Function Selection	<b>V/f</b> <b>CL-V/f</b> <b>OLV</b> <b>CLV</b> <b>AOLV</b> <b>OLV/PM</b> <b>AOLV/PM</b> <b>CLV/PM</b> <b>EZOLV</b> Sets the function for terminal DD of the DI-A3 when $F3-01 = 8$ [Digital Input Function Selection = Multi-Function Digital Input].	F (1 - 19F)	833
F3-24 (0BF1) Expert	Terminal DE Function Selection	<b>V/f</b> <b>CL-V/f</b> <b>OLV</b> <b>CLV</b> <b>AOLV</b> <b>OLV/PM</b> <b>AOLV/PM</b> <b>CLV/PM</b> <b>EZOLV</b> Sets the function for terminal DE of the DI-A3 when $F3-01 = 8$ [Digital Input Function Selection = Multi-Function Digital Input].	F (1 - 19F)	833
F3-25 (0BF2) Expert	Terminal DF Function Selection	<b>V/f</b> <b>CL-V/f</b> <b>OLV</b> <b>CLV</b> <b>AOLV</b> <b>OLV/PM</b> <b>AOLV/PM</b> <b>CLV/PM</b> <b>EZOLV</b> Sets the function for terminal DF of the DI-A3 when $F3-01 = 8$ [Digital Input Function Selection = Multi-Function Digital Input].	F (1 - 19F)	834

#### ◆ F4: Analog Monitor Option

No. (Hex.)	Name	Description	Default (Range)	Ref.
F4-01 (0391)	Terminal V1 Function Selection	<b>V/f</b> <b>CL-V/f</b> <b>OLV</b> <b>CLV</b> <b>AOLV</b> <b>OLV/PM</b> <b>AOLV/PM</b> <b>CLV/PM</b> <b>EZOLV</b> Sets the monitor signal output from terminal V1.	102 (000 - 999)	834
F4-02 (0392) RUN	Terminal V1 Gain	<b>V/f</b> <b>CL-V/f</b> <b>OLV</b> <b>CLV</b> <b>AOLV</b> <b>OLV/PM</b> <b>AOLV/PM</b> <b>CLV/PM</b> <b>EZOLV</b> Sets the gain of the monitor signal that is sent from terminal V1. Sets the analog signal output level from the terminal V1 at 10 V or 20 mA as 100% when an output for monitoring items is 100%.	100.0% (-999.9 - +999.9%)	834
F4-03 (0393)	Terminal V2 Function Selection	<b>V/f</b> <b>CL-V/f</b> <b>OLV</b> <b>CLV</b> <b>AOLV</b> <b>OLV/PM</b> <b>AOLV/PM</b> <b>CLV/PM</b> <b>EZOLV</b> Sets the number for monitor item of output from terminal V2.	103 (000 - 999)	835
F4-04 (0394) RUN	Terminal V2 Gain	<b>V/f</b> <b>CL-V/f</b> <b>OLV</b> <b>CLV</b> <b>AOLV</b> <b>OLV/PM</b> <b>AOLV/PM</b> <b>CLV/PM</b> <b>EZOLV</b> Sets the gain of the monitor signal that is sent from terminal V2. When an output for monitoring items is 0%, this parameter sets the analog signal output level from the V2 terminal at 10 V or 20 mA as 100%.	50.0% (-999.9 - +999.9%)	835
F4-05 (0395) RUN	Terminal V1 Bias	<b>V/f</b> <b>CL-V/f</b> <b>OLV</b> <b>CLV</b> <b>AOLV</b> <b>OLV/PM</b> <b>AOLV/PM</b> <b>CLV/PM</b> <b>EZOLV</b> Sets the bias of the monitor signal that is sent from terminal V1. Set the level of the analog signal sent from the V1 terminal at 10 V or 20 mA as 100% when an output for monitoring items is 0%.	0.0% (-999.9 - +999.9%)	835
F4-06 (0396) RUN	Terminal V2 Bias	<b>V/f</b> <b>CL-V/f</b> <b>OLV</b> <b>CLV</b> <b>AOLV</b> <b>OLV/PM</b> <b>AOLV/PM</b> <b>CLV/PM</b> <b>EZOLV</b> Sets the bias of the monitor signal that is sent from terminal V2. Set the level of the analog signal sent from the V2 terminal at 10 V or 20 mA as 100% when an output for monitoring items is 0%.	0.0% (-999.9 - +999.9%)	836
F4-07 (0397)	Terminal V1 Signal Level	<b>V/f</b> <b>CL-V/f</b> <b>OLV</b> <b>CLV</b> <b>AOLV</b> <b>OLV/PM</b> <b>AOLV/PM</b> <b>CLV/PM</b> <b>EZOLV</b> Sets the output signal level for terminal V1. 0 : 0 to 10 V 1 : -10 to 10 V	0 (0, 1)	836
F4-08 (0398)	Terminal V2 Signal Level	<b>V/f</b> <b>CL-V/f</b> <b>OLV</b> <b>CLV</b> <b>AOLV</b> <b>OLV/PM</b> <b>AOLV/PM</b> <b>CLV/PM</b> <b>EZOLV</b> Sets the output signal level for terminal V2. 0 : 0 to 10 V 1 : -10 to 10 V	0 (0, 1)	836

## ◆ F5: Digital Output Option

No. (Hex.)	Name	Description	Default (Range)	Ref.
F5-01 (0399)	Terminal P1-PC Function Select	<b>V/f</b> <b>CL-V/f</b> <b>OLV</b> <b>CLV</b> <b>AOLV</b> <b>OLV/PM</b> <b>AOLV/PM</b> <b>CLV/PM</b> <b>EZOLV</b> Sets the function of terminal P1-PC on the DO-A3 option. Set <i>F5-09 = 2</i> [ <i>DO-A3 Output Mode Selection = Programmable (F5-01 to F5-08)</i> ] to enable this function.	0 (0 - 1A7)	838
F5-02 (039A)	Terminal P2-PC Function Select	<b>V/f</b> <b>CL-V/f</b> <b>OLV</b> <b>CLV</b> <b>AOLV</b> <b>OLV/PM</b> <b>AOLV/PM</b> <b>CLV/PM</b> <b>EZOLV</b> Sets the function of terminal P2-PC on the DO-A3 option. Set <i>F5-09 = 2</i> [ <i>DO-A3 Output Mode Selection = Programmable (F5-01 to F5-08)</i> ] to enable this function.	1 (0 - 1A7)	838
F5-03 (039B)	Terminal P3-PC Function Select	<b>V/f</b> <b>CL-V/f</b> <b>OLV</b> <b>CLV</b> <b>AOLV</b> <b>OLV/PM</b> <b>AOLV/PM</b> <b>CLV/PM</b> <b>EZOLV</b> Sets the function of terminal P3-PC on the DO-A3 option. Set <i>F5-09 = 2</i> [ <i>DO-A3 Output Mode Selection = Programmable (F5-01 to F5-08)</i> ] to enable this function.	2 (0 - 1A7)	838
F5-04 (039C)	Terminal P4-PC Function Select	<b>V/f</b> <b>CL-V/f</b> <b>OLV</b> <b>CLV</b> <b>AOLV</b> <b>OLV/PM</b> <b>AOLV/PM</b> <b>CLV/PM</b> <b>EZOLV</b> Sets the function of terminal P4-PC on the DO-A3 option. Set <i>F5-09 = 2</i> [ <i>DO-A3 Output Mode Selection = Programmable (F5-01 to F5-08)</i> ] to enable this function.	4 (0 - 1A7)	838
F5-05 (039D)	Terminal P5-PC Function Select	<b>V/f</b> <b>CL-V/f</b> <b>OLV</b> <b>CLV</b> <b>AOLV</b> <b>OLV/PM</b> <b>AOLV/PM</b> <b>CLV/PM</b> <b>EZOLV</b> Sets the function of terminal P5-PC on the DO-A3 option. Set <i>F5-09 = 2</i> [ <i>DO-A3 Output Mode Selection = Programmable (F5-01 to F5-08)</i> ] to enable this function.	6 (0 - 1A7)	839
F5-06 (039E)	Terminal P6-PC Function Select	<b>V/f</b> <b>CL-V/f</b> <b>OLV</b> <b>CLV</b> <b>AOLV</b> <b>OLV/PM</b> <b>AOLV/PM</b> <b>CLV/PM</b> <b>EZOLV</b> Sets the function of terminal P6-PC on the DO-A3 option. Set <i>F5-09 = 2</i> [ <i>DO-A3 Output Mode Selection = Programmable (F5-01 to F5-08)</i> ] to enable this function.	37 (0 - 1A7)	839
F5-07 (039F)	Terminal M1-M2 Function Select	<b>V/f</b> <b>CL-V/f</b> <b>OLV</b> <b>CLV</b> <b>AOLV</b> <b>OLV/PM</b> <b>AOLV/PM</b> <b>CLV/PM</b> <b>EZOLV</b> Sets the function of terminal M3-M2 on the DO-A3 option. Set <i>F5-09 = 2</i> [ <i>DO-A3 Output Mode Selection = Programmable (F5-01 to F5-08)</i> ] to enable this function.	F (0 - 1A7)	839
F5-08 (03A0)	Terminal M3-M4 Function Select	<b>V/f</b> <b>CL-V/f</b> <b>OLV</b> <b>CLV</b> <b>AOLV</b> <b>OLV/PM</b> <b>AOLV/PM</b> <b>CLV/PM</b> <b>EZOLV</b> Sets the function of terminal M3-M4 on the DO-A3 option. Set <i>F5-09 = 2</i> [ <i>DO-A3 Output Mode Selection = Programmable (F5-01 to F5-08)</i> ] to enable this function.	F (0 - 1A7)	839
F5-09 (03A1)	DO-A3 Output Mode Selection	<b>V/f</b> <b>CL-V/f</b> <b>OLV</b> <b>CLV</b> <b>AOLV</b> <b>OLV/PM</b> <b>AOLV/PM</b> <b>CLV/PM</b> <b>EZOLV</b> Sets the output mode of signals from the DO-A3 option. 0 : Predefined Individual Outputs 1 : Binary Output 2 : Programmable (F5-01 to F5-08)	0 (0 - 2)	839

## ◆ F6: Communication Options

No. (Hex.)	Name	Description	Default (Range)	Ref.
F6-01 (03A2)	Communication Error Selection	<b>V/f</b> <b>CL-V/f</b> <b>OLV</b> <b>CLV</b> <b>AOLV</b> <b>OLV/PM</b> <b>AOLV/PM</b> <b>CLV/PM</b> <b>EZOLV</b> Sets the method to stop the motor or let the motor continue operating when the drive detects a <i>bUS</i> [ <i>Option Communication Error</i> ]. 0 : Ramp to Stop 1 : Coast to Stop 2 : Fast Stop (Use C1-09) 3 : Alarm Only 4 : Alarm (Run at d1-04) 5 : Alarm - Ramp Stop	1 (0 - 5)	841
F6-02 (03A3)	Comm External Fault (EF0) Detect	<b>V/f</b> <b>CL-V/f</b> <b>OLV</b> <b>CLV</b> <b>AOLV</b> <b>OLV/PM</b> <b>AOLV/PM</b> <b>CLV/PM</b> <b>EZOLV</b> Sets when the drive will detect <i>EF0</i> [ <i>Option Card External Fault</i> ] is detected. 0 : Always Detected 1 : Detected during RUN Only	0 (0, 1)	841



No. (Hex.)	Name	Description	Default (Range)	Ref.
F6-03 (03A4)	Comm External Fault (EF0) Select	<p><b>V/f</b> <b>CL-V/f</b> <b>OLV</b> <b>CLV</b> <b>AOLV</b> <b>OLV/PM</b> <b>AOLV/PM</b> <b>CLV/PM</b> <b>EZOLV</b></p> <p>Sets the method to stop the motor or let the motor continue operating when the drive detects an <i>EF0</i> [Option Card External Fault].</p> <p>0 : Ramp to Stop 1 : Coast to Stop 2 : Fast Stop (Use C1-09) 3 : Alarm Only</p>	1 (0 - 3)	841
F6-04 (03A5)	bUS Error Detection Time	<p><b>V/f</b> <b>CL-V/f</b> <b>OLV</b> <b>CLV</b> <b>AOLV</b> <b>OLV/PM</b> <b>AOLV/PM</b> <b>CLV/PM</b> <b>EZOLV</b></p> <p>Sets the delay time for the drive to detect <i>bUS</i> [Option Communication Error].</p> <p><b>Note:</b> When you install an option card in the drive, the parameter value changes to 0.0 s.</p>	2.0 s (0.0 - 5.0 s)	842
F6-06 (03A7)	Torque Reference/Limit by Comm	<p><b>V/f</b> <b>CL-V/f</b> <b>OLV</b> <b>CLV</b> <b>AOLV</b> <b>OLV/PM</b> <b>AOLV/PM</b> <b>CLV/PM</b> <b>EZOLV</b></p> <p>Sets the function that enables and disables the torque reference and torque limit received from the communication option.</p> <p>0 : Disabled 1 : Enabled</p>	0 (0, 1)	842
F6-07 (03A8)	Multi-Step Ref @ NetRef/ComRef	<p><b>V/f</b> <b>CL-V/f</b> <b>OLV</b> <b>CLV</b> <b>AOLV</b> <b>OLV/PM</b> <b>AOLV/PM</b> <b>CLV/PM</b> <b>EZOLV</b></p> <p>Sets the function that enables and disables the multi-step speed reference when the frequency reference source is NetRef or ComRef (communication option card or MEMOBUS/Modbus communications).</p> <p>0 : Disable Multi-Step References 1 : Enable Multi-Step References</p>	0 (0, 1)	842
F6-08 (036A)	Comm Parameter Reset @Initialize	<p><b>V/f</b> <b>CL-V/f</b> <b>OLV</b> <b>CLV</b> <b>AOLV</b> <b>OLV/PM</b> <b>AOLV/PM</b> <b>CLV/PM</b> <b>EZOLV</b></p> <p>Sets the function to initialize <i>F6-xx</i> and <i>F7-xx</i> parameters when the drive is initialized with <i>A1-03</i> [Initialize Parameters].</p> <p>0 : No Reset - Parameters Retained 1 : Reset Back to Factory Default</p>	0 (0, 1)	842
F6-10 (03B6)	CC-Link Node Address	<p><b>V/f</b> <b>CL-V/f</b> <b>OLV</b> <b>CLV</b> <b>AOLV</b> <b>OLV/PM</b> <b>AOLV/PM</b> <b>CLV/PM</b> <b>EZOLV</b></p> <p>Sets the node address for CC-Link communication. Restart the drive after changing this setting.</p> <p><b>Note:</b> Be sure to set a node address that is different than all other node addresses. Do not set this parameter to 0. Incorrect parameter settings will cause <i>AEr</i> [Station Address Setting Error] errors and the L.ERR LED on the option will come on.</p>	0 (0 - 64)	843
F6-11 (03B7)	CC-Link Communication Speed	<p><b>V/f</b> <b>CL-V/f</b> <b>OLV</b> <b>CLV</b> <b>AOLV</b> <b>OLV/PM</b> <b>AOLV/PM</b> <b>CLV/PM</b> <b>EZOLV</b></p> <p>Sets the communication speed for CC-Link communication. Restart the drive after you change this setting.</p> <p>0 : 156 kbps 1 : 625 kbps 2 : 2.5 Mbps 3 : 5 Mbps 4 : 10 Mbps</p>	0 (0 - 4)	843
F6-14 (03BB)	BUS Error Auto Reset	<p><b>V/f</b> <b>CL-V/f</b> <b>OLV</b> <b>CLV</b> <b>AOLV</b> <b>OLV/PM</b> <b>AOLV/PM</b> <b>CLV/PM</b> <b>EZOLV</b></p> <p>Sets the automatic reset function for <i>bUS</i> [Option Communication Errors].</p> <p>0 : Disabled 1 : Enabled</p>	0 (0, 1)	843
F6-16 (0B8A)	Gateway Mode	<p><b>V/f</b> <b>CL-V/f</b> <b>OLV</b> <b>CLV</b> <b>AOLV</b> <b>OLV/PM</b> <b>AOLV/PM</b> <b>CLV/PM</b> <b>EZOLV</b></p> <p>Sets the gateway mode operation and the number of connected slave drives.</p> <p>0 : Disabled 1 : Enabled: 1 Slave Drive 2 : Enabled: 2 Slave Drives 3 : Enabled: 3 Slave Drives 4 : Enabled: 4 Slave Drives</p>	0 (0 - 4)	843

No. (Hex.)	Name	Description	Default (Range)	Ref.
F6-20 (036B)	MECHATROLINK Station Address	<p><b>V/f</b> <b>CL-V/f</b> <b>OLV</b> <b>CLV</b> <b>AOLV</b> <b>OLV/PM</b> <b>AOLV/PM</b> <b>CLV/PM</b> <b>EZOLV</b></p> <p>Sets the station address for MECHATROLINK communication. Restart the drive after changing this setting.</p> <p><b>Note:</b></p> <ul style="list-style-type: none"> <li>The setting range changes if using MECHATROLINK-II or MECHATROLINK-III:                             <ul style="list-style-type: none"> <li>–MECHATROLINK-II (SI-T3) range: 20 - 3F</li> <li>–MECHATROLINK-III (SI-ET3) range: 03 - EF</li> </ul> </li> <li>Be sure to set a node address that is different than all other node addresses. Incorrect parameter settings will cause <i>AEr [Station Address Setting Error]</i> errors and the L.ERR LED on the option will come on.</li> <li>The drive detects <i>AEr</i> errors when the station address is 20 or 3F.</li> </ul>	0021h (MECHATROLINK-II : 0020h - 003Fh , MECHATROLINK-III : 0003h - 00EFh)	847
F6-21 (036C)	MECHATROLINK Frame Size	<p><b>V/f</b> <b>CL-V/f</b> <b>OLV</b> <b>CLV</b> <b>AOLV</b> <b>OLV/PM</b> <b>AOLV/PM</b> <b>CLV/PM</b> <b>EZOLV</b></p> <p>Sets the frame size for MECHATROLINK communication. Restart the drive after you change this setting.</p> <p>0 : 32byte (M-2) / 64byte (M-3) 1 : 17byte (M-2) / 32byte (M-3)</p>	0 (0, 1)	847
F6-22 (036D)	MECHATROLINK Link Speed	<p><b>V/f</b> <b>CL-V/f</b> <b>OLV</b> <b>CLV</b> <b>AOLV</b> <b>OLV/PM</b> <b>AOLV/PM</b> <b>CLV/PM</b> <b>EZOLV</b></p> <p>Sets the communications speed for MECHATROLINK-II. Restart the drive after you change this setting.</p> <p><b>Note:</b> This parameter is only available with the MECHATROLINK-II option.</p> <p>0 : 10 Mbps 1 : 4 Mbps</p>	0 (0, 1)	847
F6-23 (036E)	MECHATROLINK Monitor Select (E)	<p><b>V/f</b> <b>CL-V/f</b> <b>OLV</b> <b>CLV</b> <b>AOLV</b> <b>OLV/PM</b> <b>AOLV/PM</b> <b>CLV/PM</b> <b>EZOLV</b></p> <p>Sets the MEMOBUS register used for the monitor functions of INV_CTL (drive operation control command) and INV_I/O (drive I/O control command). Restart the drive after you change this setting.</p>	0000h (0000h - FFFFh)	848
F6-24 (036F)	MECHATROLINK Monitor Select (F)	<p><b>V/f</b> <b>CL-V/f</b> <b>OLV</b> <b>CLV</b> <b>AOLV</b> <b>OLV/PM</b> <b>AOLV/PM</b> <b>CLV/PM</b> <b>EZOLV</b></p> <p>Sets the MEMOBUS register used for the monitor functions of INV_CTL (drive operation control command) and INV_I/O (drive I/O control command). Restart the drive after you change this setting.</p>	0000h (0000h - FFFFh)	848
F6-25 (03C9)	MECHATROLINK Watchdog Error Sel	<p><b>V/f</b> <b>CL-V/f</b> <b>OLV</b> <b>CLV</b> <b>AOLV</b> <b>OLV/PM</b> <b>AOLV/PM</b> <b>CLV/PM</b> <b>EZOLV</b></p> <p>Sets the method to stop the motor or let the motor continue operating when the drive detects an <i>E5 [MECHATROLINK Watchdog Timer Err]</i>.</p> <p>0 : Ramp to Stop 1 : Coast to Stop 2 : Fast Stop (Use C1-09) 3 : Alarm Only</p>	1 (0 - 3)	848
F6-26 (03CA)	MECHATROLINK Allowable No of Err	<p><b>V/f</b> <b>CL-V/f</b> <b>OLV</b> <b>CLV</b> <b>AOLV</b> <b>OLV/PM</b> <b>AOLV/PM</b> <b>CLV/PM</b> <b>EZOLV</b></p> <p>Sets the number of times that the option must detect a <i>bUS</i> alarm to cause a <i>bUS [Option Communication Error]</i>.</p>	2 times (2 - 10 times)	848
F6-30 (03CB)	PROFIBUS-DP Node Address	<p><b>V/f</b> <b>CL-V/f</b> <b>OLV</b> <b>CLV</b> <b>AOLV</b> <b>OLV/PM</b> <b>AOLV/PM</b> <b>CLV/PM</b> <b>EZOLV</b></p> <p>Sets the node address for PROFIBUS-DP communication. Restart the drive after changing this setting.</p> <p><b>Note:</b> Be sure to set a node address that is different than all other node addresses.</p>	0 (0 - 125)	849
F6-31 (03CC)	PROFIBUS-DP Clear Mode Selection	<p><b>V/f</b> <b>CL-V/f</b> <b>OLV</b> <b>CLV</b> <b>AOLV</b> <b>OLV/PM</b> <b>AOLV/PM</b> <b>CLV/PM</b> <b>EZOLV</b></p> <p>Sets what the drive will do after it receives the Clear Mode command.</p> <p>0 : Reset 1 : Hold Previous State</p>	0 (0, 1)	849

No. (Hex.)	Name	Description	Default (Range)	Ref.
F6-32 (03CD)	PROFIBUS-DP Data Format Select	<p><b>V/f</b> <b>CL-V/f</b> <b>OLV</b> <b>CLV</b> <b>AOLV</b> <b>OLV/PM</b> <b>AOLV/PM</b> <b>CLV/PM</b> <b>EZOLV</b></p> <p>Sets the data format of PROFIBUS-DP communication. Restart the drive after changing this setting.</p> <p>0 : PPO Type 1 : Conventional 2 : PPO (bit0) 3 : PPO (Enter) 4 : Conventional (Enter) 5 : PPO (bit0, Enter)</p>	0 (0 - 5)	849
F6-35 (03D0)	CANopen Node ID Selection	<p><b>V/f</b> <b>CL-V/f</b> <b>OLV</b> <b>CLV</b> <b>AOLV</b> <b>OLV/PM</b> <b>AOLV/PM</b> <b>CLV/PM</b> <b>EZOLV</b></p> <p>Sets the node address for CANopen communication. Restart the drive after changing this setting.</p> <p><b>Note:</b> Be sure to set an address that is different than all other node addresses. Do not set this parameter to 0. Incorrect parameter settings will cause <i>AER [Station Address Setting Error]</i> errors and the L.ERR LED on the option will come on.</p>	0 (0 - 126)	849
F6-36 (03D1)	CANopen Communication Speed	<p><b>V/f</b> <b>CL-V/f</b> <b>OLV</b> <b>CLV</b> <b>AOLV</b> <b>OLV/PM</b> <b>AOLV/PM</b> <b>CLV/PM</b> <b>EZOLV</b></p> <p>Sets the CANopen communications speed. Restart the drive after you change this setting.</p> <p>0 : Auto-detection 1 : 10 kbps 2 : 20 kbps 3 : 50 kbps 4 : 125 kbps 5 : 250 kbps 6 : 500 kbps 7 : 800 kbps 8 : 1 Mbps</p>	0 (0 - 8)	850
F6-45 (02FB)	BACnet Node Address	<p><b>V/f</b> <b>CL-V/f</b> <b>OLV</b> <b>CLV</b> <b>AOLV</b> <b>OLV/PM</b> <b>AOLV/PM</b> <b>CLV/PM</b> <b>EZOLV</b></p> <p>Sets the node address for BACnet communication.</p> <p><b>Note:</b> Set a node address that is unique. Do not set this parameter to a value of 0.</p>	1 (0 - 127)	850
F6-46 (02FC)	BACnet Baud Rate	<p><b>V/f</b> <b>CL-V/f</b> <b>OLV</b> <b>CLV</b> <b>AOLV</b> <b>OLV/PM</b> <b>AOLV/PM</b> <b>CLV/PM</b> <b>EZOLV</b></p> <p>Sets the BACnet communications speed.</p> <p>0 : 1200 bps 1 : 2400 bps 2 : 4800 bps 3 : 9600 bps 4 : 19.2 kbps 5 : 38.4 kbps 6 : 57.6 kbps 7 : 76.8 kbps 8 : 115.2 kbps</p>	3 (0 - 8)	850
F6-47 (02FD)	Rx to Tx Wait Time	<p><b>V/f</b> <b>CL-V/f</b> <b>OLV</b> <b>CLV</b> <b>AOLV</b> <b>OLV/PM</b> <b>AOLV/PM</b> <b>CLV/PM</b> <b>EZOLV</b></p> <p>Sets the wait time for the drive to receive and send BACnet communication.</p>	5 ms (5 - 65 ms)	850
F6-48 (02FE)	BACnet Device Object Identifier0	<p><b>V/f</b> <b>CL-V/f</b> <b>OLV</b> <b>CLV</b> <b>AOLV</b> <b>OLV/PM</b> <b>AOLV/PM</b> <b>CLV/PM</b> <b>EZOLV</b></p> <p>Sets the last word of BACnet communication addresses.</p>	0 (0 - FFFF)	850
F6-49 (02FF)	BACnet Device Object Identifier1	<p><b>V/f</b> <b>CL-V/f</b> <b>OLV</b> <b>CLV</b> <b>AOLV</b> <b>OLV/PM</b> <b>AOLV/PM</b> <b>CLV/PM</b> <b>EZOLV</b></p> <p>Sets the last word of BACnet communication addresses.</p>	0 (0 - 3F)	851

## 10.9 F: Options

No. (Hex.)	Name	Description	Default (Range)	Ref.
F6-50 (03C1)	DeviceNet MAC Address	<p><b>V/f</b> <b>CL-V/f</b> <b>OLV</b> <b>CLV</b> <b>AOLV</b> <b>OLV/PM</b> <b>AOLV/PM</b> <b>CLV/PM</b> <b>EZOLV</b></p> <p>Sets the MAC address for DeviceNet communication. Restart the drive after you change this setting.</p> <p><b>Note:</b> Be sure to set a MAC address that is different than all other node addresses. Do not set this parameter to 0. Incorrect parameter settings will cause <i>AEr [Station Address Setting Error]</i> errors and the MS LED on the option will flash.</p>	0 (0 - 64)	851
F6-51 (03C2)	DeviceNet Baud Rate	<p><b>V/f</b> <b>CL-V/f</b> <b>OLV</b> <b>CLV</b> <b>AOLV</b> <b>OLV/PM</b> <b>AOLV/PM</b> <b>CLV/PM</b> <b>EZOLV</b></p> <p>Sets the DeviceNet communications speed. Restart the drive after you change this setting.</p> <p>0 : 125 kbps 1 : 250 kbps 2 : 500 kbps 3 : Adjustable from Network 4 : Detect Automatically</p>	0 (0 - 4)	851
F6-52 (03C3)	DeviceNet PCA Setting	<p><b>V/f</b> <b>CL-V/f</b> <b>OLV</b> <b>CLV</b> <b>AOLV</b> <b>OLV/PM</b> <b>AOLV/PM</b> <b>CLV/PM</b> <b>EZOLV</b></p> <p>Sets the format of data that the DeviceNet communication master sends to the drive.</p>	21 (0 - 255)	851
F6-53 (03C4)	DeviceNet PPA Setting	<p><b>V/f</b> <b>CL-V/f</b> <b>OLV</b> <b>CLV</b> <b>AOLV</b> <b>OLV/PM</b> <b>AOLV/PM</b> <b>CLV/PM</b> <b>EZOLV</b></p> <p>Sets the format of data that the drive sends to the DeviceNet communication master.</p>	71 (0 - 255)	851
F6-54 (03C5)	DeviceNet Idle Fault Detection	<p><b>V/f</b> <b>CL-V/f</b> <b>OLV</b> <b>CLV</b> <b>AOLV</b> <b>OLV/PM</b> <b>AOLV/PM</b> <b>CLV/PM</b> <b>EZOLV</b></p> <p>Sets the function to detect <i>EF0 [Option Card External Fault]</i> when the drive does not receive data from the DeviceNet master.</p> <p>0 : Enabled 1 : Disabled, No Fault Detection 2 : Vendor Specific 3 : RUN Forward 4 : RUN Reverse</p>	0 (0 - 4)	852
F6-55 (03C6)	DeviceNet Baud Rate Monitor	<p><b>V/f</b> <b>CL-V/f</b> <b>OLV</b> <b>CLV</b> <b>AOLV</b> <b>OLV/PM</b> <b>AOLV/PM</b> <b>CLV/PM</b> <b>EZOLV</b></p> <p>Sets the function to see the actual DeviceNet communications speed using the keypad. This parameter functions as a monitor only.</p> <p>0 : 125 kbps 1 : 250 kbps 2 : 500 kbps</p>	0 (0 - 2)	852
F6-56 (03D7)	DeviceNet Speed Scaling	<p><b>V/f</b> <b>CL-V/f</b> <b>OLV</b> <b>CLV</b> <b>AOLV</b> <b>OLV/PM</b> <b>AOLV/PM</b> <b>CLV/PM</b> <b>EZOLV</b></p> <p>Sets the speed scale for DeviceNet communication.</p>	0 (-15 - +15)	852
F6-57 (03D8)	DeviceNet Current Scaling	<p><b>V/f</b> <b>CL-V/f</b> <b>OLV</b> <b>CLV</b> <b>AOLV</b> <b>OLV/PM</b> <b>AOLV/PM</b> <b>CLV/PM</b> <b>EZOLV</b></p> <p>Sets the current scale of the DeviceNet communication master.</p>	0 (-15 - +15)	852
F6-58 (03D9)	DeviceNet Torque Scaling	<p><b>V/f</b> <b>CL-V/f</b> <b>OLV</b> <b>CLV</b> <b>AOLV</b> <b>OLV/PM</b> <b>AOLV/PM</b> <b>CLV/PM</b> <b>EZOLV</b></p> <p>Sets the torque scale of the DeviceNet communication master.</p>	0 (-15 - +15)	852
F6-59 (03DA)	DeviceNet Power Scaling	<p><b>V/f</b> <b>CL-V/f</b> <b>OLV</b> <b>CLV</b> <b>AOLV</b> <b>OLV/PM</b> <b>AOLV/PM</b> <b>CLV/PM</b> <b>EZOLV</b></p> <p>Sets the power scale of the DeviceNet communication master.</p>	0 (-15 - +15)	852
F6-60 (03DB)	DeviceNet Voltage Scaling	<p><b>V/f</b> <b>CL-V/f</b> <b>OLV</b> <b>CLV</b> <b>AOLV</b> <b>OLV/PM</b> <b>AOLV/PM</b> <b>CLV/PM</b> <b>EZOLV</b></p> <p>Sets the voltage scale of the DeviceNet communication master.</p>	0 (-15 - +15)	853
F6-61 (03DC)	DeviceNet Time Scaling	<p><b>V/f</b> <b>CL-V/f</b> <b>OLV</b> <b>CLV</b> <b>AOLV</b> <b>OLV/PM</b> <b>AOLV/PM</b> <b>CLV/PM</b> <b>EZOLV</b></p> <p>Sets the time scale of the DeviceNet communication master.</p>	0 (-15 - +15)	853
F6-62 (03DD)	DeviceNet Heartbeat Interval	<p><b>V/f</b> <b>CL-V/f</b> <b>OLV</b> <b>CLV</b> <b>AOLV</b> <b>OLV/PM</b> <b>AOLV/PM</b> <b>CLV/PM</b> <b>EZOLV</b></p> <p>Sets the heartbeat for DeviceNet communication. Set this parameter to 0 to disable the heartbeat function.</p>	0 (0 - 10)	853
F6-63 (03DE)	DeviceNet Network MAC ID	<p><b>V/f</b> <b>CL-V/f</b> <b>OLV</b> <b>CLV</b> <b>AOLV</b> <b>OLV/PM</b> <b>AOLV/PM</b> <b>CLV/PM</b> <b>EZOLV</b></p> <p>Sets the function to see the actual DeviceNet MAC address using the keypad. This parameter functions as a monitor only.</p>	0 (0 - 63)	853

No. (Hex.)	Name	Description	Default (Range)	Ref.
F6-64 to F6-67 (03DF - 03E2)	Dynamic Out Assembly 109 Param 1 to 4	<b>V/f</b> <b>CL-V/f</b> <b>OLV</b> <b>CLV</b> <b>AOLV</b> <b>OLV/PM</b> <b>AOLV/PM</b> <b>CLV/PM</b> <b>EZOLV</b> Sets Configurable Outputs 1 to 4 written to the MEMOBUS register.	0000h (0000h - FFFFh)	853
F6-68 to F6-71 (03E3, 03E4, 03C7, and 03C8)	Dynamic In Assembly 159 Param 1 to 4	<b>V/f</b> <b>CL-V/f</b> <b>OLV</b> <b>CLV</b> <b>AOLV</b> <b>OLV/PM</b> <b>AOLV/PM</b> <b>CLV/PM</b> <b>EZOLV</b> Sets Configurable Inputs 1 to 4 written to the MEMOBUS register.	0000h (0000h - FFFFh)	853
F6-72 (081B)	PowerLink Node Address	<b>V/f</b> <b>CL-V/f</b> <b>OLV</b> <b>CLV</b> <b>AOLV</b> <b>OLV/PM</b> <b>AOLV/PM</b> <b>CLV/PM</b> <b>EZOLV</b> Sets the node ID for PowerLink communication. <b>Note:</b> Set a node address that is unique. Do not set this parameter to a value of 0.	0 (0 - 255)	853

## ◆ F7: Ethernet Options

No. (Hex.)	Name	Description	Default (Range)	Ref.
F7-01 (03E5)	IP Address 1	<b>V/f</b> <b>CL-V/f</b> <b>OLV</b> <b>CLV</b> <b>AOLV</b> <b>OLV/PM</b> <b>AOLV/PM</b> <b>CLV/PM</b> <b>EZOLV</b> Sets the first octet of the IP Address for the device that is connecting to the network. Restart the drive after you change this parameter. <b>Note:</b> When $F7-13 = 0$ [Address Mode at Startup = Static]: • Use parameters $F7-01$ to $F7-04$ [IP Address 4] to set the IP Address. Be sure to set a different IP address for each drive on the network. • Also set parameters $F7-01$ to $F7-12$ .	192 (0 - 255)	854
F7-02 (03E6)	IP Address 2	<b>V/f</b> <b>CL-V/f</b> <b>OLV</b> <b>CLV</b> <b>AOLV</b> <b>OLV/PM</b> <b>AOLV/PM</b> <b>CLV/PM</b> <b>EZOLV</b> Sets the second octet of the IP Address for the device that is connecting to the network. Restart the drive after you change this parameter. <b>Note:</b> When $F7-13 = 0$ [Address Mode at Startup = Static]: • Use parameters $F7-01$ to $F7-04$ [IP Address 4] to set the IP Address. Be sure to set a different IP address for each drive on the network. • Also set parameters $F7-01$ to $F7-12$ .	168 (0 - 255)	854
F7-03 (03E7)	IP Address 3	<b>V/f</b> <b>CL-V/f</b> <b>OLV</b> <b>CLV</b> <b>AOLV</b> <b>OLV/PM</b> <b>AOLV/PM</b> <b>CLV/PM</b> <b>EZOLV</b> Sets the third octet of the IP Address for the device that is connecting to the network. Restart the drive after you change this parameter. <b>Note:</b> When $F7-13 = 0$ [Address Mode at Startup = Static]: • Use parameters $F7-01$ to $F7-04$ [IP Address 4] to set the IP Address. Be sure to set a different IP address for each drive on the network. • Also set parameters $F7-01$ to $F7-12$ .	1 (0 - 255)	854
F7-04 (03E8)	IP Address 4	<b>V/f</b> <b>CL-V/f</b> <b>OLV</b> <b>CLV</b> <b>AOLV</b> <b>OLV/PM</b> <b>AOLV/PM</b> <b>CLV/PM</b> <b>EZOLV</b> Sets the fourth octet of the IP Address for the device that is connecting to the network. Restart the drive after you change this parameter. <b>Note:</b> When $F7-13 = 0$ [Address Mode at Startup = Static]: • Use parameters $F7-01$ to $F7-04$ [IP Address 4] to set the IP Address. Be sure to set a different IP address for each drive on the network. • Also set parameters $F7-01$ to $F7-12$ .	20 (0 - 255)	854
F7-05 (03E9)	Subnet Mask 1	<b>V/f</b> <b>CL-V/f</b> <b>OLV</b> <b>CLV</b> <b>AOLV</b> <b>OLV/PM</b> <b>AOLV/PM</b> <b>CLV/PM</b> <b>EZOLV</b> Sets the first octet of the subnet mask of the connected network. <b>Note:</b> Set this parameter when $F7-13 = 0$ [Address Mode at Startup = Static].	255 (0 - 255)	854

No. (Hex.)	Name	Description	Default (Range)	Ref.
F7-06 (03EA)	Subnet Mask 2	<p><b>V/f</b> <b>CL-V/f</b> <b>OLV</b> <b>CLV</b> <b>AOLV</b> <b>OLV/PM</b> <b>AOLV/PM</b> <b>CLV/PM</b> <b>EZOLV</b></p> <p>Sets the second octet of the subnet mask of the connected network.</p> <p><b>Note:</b> Set this parameter when <math>F7-13 = 0</math> [Address Mode at Startup = Static].</p>	255 (0 - 255)	855
F7-07 (03EB)	Subnet Mask 3	<p><b>V/f</b> <b>CL-V/f</b> <b>OLV</b> <b>CLV</b> <b>AOLV</b> <b>OLV/PM</b> <b>AOLV/PM</b> <b>CLV/PM</b> <b>EZOLV</b></p> <p>Sets the third octet of the subnet mask of the connected network.</p> <p><b>Note:</b> Set this parameter when <math>F7-13 = 0</math> [Address Mode at Startup = Static].</p>	255 (0 - 255)	855
F7-08 (03EC)	Subnet Mask 4	<p><b>V/f</b> <b>CL-V/f</b> <b>OLV</b> <b>CLV</b> <b>AOLV</b> <b>OLV/PM</b> <b>AOLV/PM</b> <b>CLV/PM</b> <b>EZOLV</b></p> <p>Sets the fourth octet of the subnet mask of the connected network.</p> <p><b>Note:</b> Set this parameter when <math>F7-13 = 0</math> [Address Mode at Startup = Static].</p>	0 (0 - 255)	855
F7-09 (03ED)	Gateway Address 1	<p><b>V/f</b> <b>CL-V/f</b> <b>OLV</b> <b>CLV</b> <b>AOLV</b> <b>OLV/PM</b> <b>AOLV/PM</b> <b>CLV/PM</b> <b>EZOLV</b></p> <p>Sets the first octet of the gateway address of the connected network.</p> <p><b>Note:</b> Set this parameter when <math>F7-13 = 0</math> [Address Mode at Startup = Static].</p>	192 (0 - 255)	855
F7-10 (03EE)	Gateway Address 2	<p><b>V/f</b> <b>CL-V/f</b> <b>OLV</b> <b>CLV</b> <b>AOLV</b> <b>OLV/PM</b> <b>AOLV/PM</b> <b>CLV/PM</b> <b>EZOLV</b></p> <p>Sets the second octet of the gateway address of the connected network.</p> <p><b>Note:</b> Set this parameter when <math>F7-13 = 0</math> [Address Mode at Startup = Static].</p>	168 (0 - 255)	855
F7-11 (03EF)	Gateway Address 3	<p><b>V/f</b> <b>CL-V/f</b> <b>OLV</b> <b>CLV</b> <b>AOLV</b> <b>OLV/PM</b> <b>AOLV/PM</b> <b>CLV/PM</b> <b>EZOLV</b></p> <p>Sets the third octet of the gateway address of the connected network.</p> <p><b>Note:</b> Set this parameter when <math>F7-13 = 0</math> [Address Mode at Startup = Static].</p>	1 (0 - 255)	855
F7-12 (03F0)	Gateway Address 4	<p><b>V/f</b> <b>CL-V/f</b> <b>OLV</b> <b>CLV</b> <b>AOLV</b> <b>OLV/PM</b> <b>AOLV/PM</b> <b>CLV/PM</b> <b>EZOLV</b></p> <p>Sets the fourth octet of the gateway address of the connected network.</p> <p><b>Note:</b> Set this parameter when <math>F7-13 = 0</math> [Address Mode at Startup = Static].</p>	1 (0 - 255)	856
F7-13 (03F1)	Address Mode at Startup	<p><b>V/f</b> <b>CL-V/f</b> <b>OLV</b> <b>CLV</b> <b>AOLV</b> <b>OLV/PM</b> <b>AOLV/PM</b> <b>CLV/PM</b> <b>EZOLV</b></p> <p>Sets the method to set option card IP addresses.</p> <p>0 : Static 1 : BOOTP 2 : DHCP</p> <p><b>Note:</b></p> <ul style="list-style-type: none"> <li>The following setting values are available when using the PROFINET communication option card (SI-EP3). -0: Static -2: DCP</li> <li>When <math>F7-13 = 0</math>, set parameters <math>F7-01</math> to <math>F7-12</math> [IP Address 1 to Gateway Address 4] to set the IP Address. Be sure to set a different IP address for each drive on the network.</li> </ul>	2 (0 - 2)	856

No. (Hex.)	Name	Description	Default (Range)	Ref.
F7-14 (03F2)	Duplex Mode Selection	<b>V/f</b> <b>CL-V/f</b> <b>OLV</b> <b>CLV</b> <b>AOLV</b> <b>OLV/PM</b> <b>AOLV/PM</b> <b>CLV/PM</b> <b>EZOLV</b> Sets the duplex mode setting method. 0 : Half/Half 1 : Auto/Auto 2 : Full/Full 3 : Half/Auto 4 : Half/Full 5 : Auto/Half 6 : Auto/Full 7 : Full/Half 8 : Full/Auto	1 (0 - 8)	856
F7-15 (03F3)	Communication Speed Selection	<b>V/f</b> <b>CL-V/f</b> <b>OLV</b> <b>CLV</b> <b>AOLV</b> <b>OLV/PM</b> <b>AOLV/PM</b> <b>CLV/PM</b> <b>EZOLV</b> Sets the communications speed. 10 : 10/10 Mbps 102 : 100/10 Mbps	10 (10, 102)	856
F7-16 (03F4)	Timeout Value	<b>V/f</b> <b>CL-V/f</b> <b>OLV</b> <b>CLV</b> <b>AOLV</b> <b>OLV/PM</b> <b>AOLV/PM</b> <b>CLV/PM</b> <b>EZOLV</b> Sets the detection time for a communications timeout. <b>Note:</b> Set this parameter to 0.0 to disable the connection timeout function.	0.0 s (0.0 - 30.0 s)	857
F7-17 (03F5)	EtherNet/IP Speed Scaling Factor	<b>V/f</b> <b>CL-V/f</b> <b>OLV</b> <b>CLV</b> <b>AOLV</b> <b>OLV/PM</b> <b>AOLV/PM</b> <b>CLV/PM</b> <b>EZOLV</b> Sets the scaling factor for the speed monitor in the EtherNet/IP Class ID 2AH Object.	0 (-15 - +15)	857
F7-18 (03F6)	EtherNet/IP Current Scale Factor	<b>V/f</b> <b>CL-V/f</b> <b>OLV</b> <b>CLV</b> <b>AOLV</b> <b>OLV/PM</b> <b>AOLV/PM</b> <b>CLV/PM</b> <b>EZOLV</b> Sets the scaling factor for the output current monitor in the EtherNet/IP Class ID 2AH Object.	0 (-15 - +15)	857
F7-19 (03F7)	EtherNet/IP Torque Scale Factor	<b>V/f</b> <b>CL-V/f</b> <b>OLV</b> <b>CLV</b> <b>AOLV</b> <b>OLV/PM</b> <b>AOLV/PM</b> <b>CLV/PM</b> <b>EZOLV</b> Sets the scaling factor for the torque monitor in the EtherNet/IP Class ID 2AH Object.	0 (-15 - +15)	857
F7-20 (03F8)	EtherNet/IP Power Scaling Factor	<b>V/f</b> <b>CL-V/f</b> <b>OLV</b> <b>CLV</b> <b>AOLV</b> <b>OLV/PM</b> <b>AOLV/PM</b> <b>CLV/PM</b> <b>EZOLV</b> Sets the scaling factor for the power monitor in the EtherNet/IP Class ID 2AH Object.	0 (-15 - +15)	857
F7-21 (03F9)	EtherNet/IP Voltage Scale Factor	<b>V/f</b> <b>CL-V/f</b> <b>OLV</b> <b>CLV</b> <b>AOLV</b> <b>OLV/PM</b> <b>AOLV/PM</b> <b>CLV/PM</b> <b>EZOLV</b> Sets the scaling factor for the voltage monitor in the EtherNet/IP Class ID 2AH Object.	0 (-15 - +15)	857
F7-22 (03FA)	EtherNet/IP Time Scaling	<b>V/f</b> <b>CL-V/f</b> <b>OLV</b> <b>CLV</b> <b>AOLV</b> <b>OLV/PM</b> <b>AOLV/PM</b> <b>CLV/PM</b> <b>EZOLV</b> Sets the scaling factor for the time monitor in the EtherNet/IP Class ID 2AH Object.	0 (-15 - +15)	857
F7-23 to F7-27 (03FB - 03FF) F7-28 to F7-32 (0370 - 0374)	Dynamic Out Param 1 to 10 for CommCard	<b>V/f</b> <b>CL-V/f</b> <b>OLV</b> <b>CLV</b> <b>AOLV</b> <b>OLV/PM</b> <b>AOLV/PM</b> <b>CLV/PM</b> <b>EZOLV</b> Sets Output Assembly 116. The drive writes the values from Output Assembly 116 to the MEMOBUS/Modbus address register that is stored for each parameter. The drive will not write the values from Output Assembly 116 to the registers when the MEMOBUS/Modbus address is 0.	0	858
F7-33 to F7-42 (0375 - 037E)	Dynamic In Param 1 to 10 for CommCard	<b>V/f</b> <b>CL-V/f</b> <b>OLV</b> <b>CLV</b> <b>AOLV</b> <b>OLV/PM</b> <b>AOLV/PM</b> <b>CLV/PM</b> <b>EZOLV</b> Sets Input Assembly 166. The drive sends the values from the MEMOBUS/Modbus address registers stored for each parameter to Input Assembly 166. The drive returns the default register value for the option card when the MEMOBUS/Modbus address is 0 and the value sent to Input Assembly 166 is not defined.	0	858
F7-60 (0780)	PZD1 Write (Control Word)	<b>V/f</b> <b>CL-V/f</b> <b>OLV</b> <b>CLV</b> <b>AOLV</b> <b>OLV/PM</b> <b>AOLV/PM</b> <b>CLV/PM</b> <b>EZOLV</b> Sets the MEMOBUS/Modbus address for PZD1 (PPO output). PZD1 (PPO output) functions as the STW when F7-60 = 0, 1, or 2.	0	858
F7-61 (0781)	PZD2 Write (Frequency Reference)	<b>V/f</b> <b>CL-V/f</b> <b>OLV</b> <b>CLV</b> <b>AOLV</b> <b>OLV/PM</b> <b>AOLV/PM</b> <b>CLV/PM</b> <b>EZOLV</b> Sets the MEMOBUS/Modbus address for PZD2 (PPO output). PZD2 (PPO output) functions as the HSW when F7-61 = 0, 1, or 2.	0	858

No. (Hex.)	Name	Description	Default (Range)	Ref.
F7-62 (0782)	PZD3 Write	<b>V/f</b> <b>CL-V/f</b> <b>OLV</b> <b>CLV</b> <b>AOLV</b> <b>OLV/PM</b> <b>AOLV/PM</b> <b>CLV/PM</b> <b>EZOLV</b> Sets the MEMOBUS/Modbus address for PZD3 (PPO output). A value of 0, 1, or 2 will disable the PZD3 (PPO output) write operation to the MEMOBUS/Modbus register.	0	858
F7-63 (0783)	PZD4 Write	<b>V/f</b> <b>CL-V/f</b> <b>OLV</b> <b>CLV</b> <b>AOLV</b> <b>OLV/PM</b> <b>AOLV/PM</b> <b>CLV/PM</b> <b>EZOLV</b> Sets the MEMOBUS/Modbus address for PZD4 (PPO output). A value of 0, 1, or 2 will disable the PZD4 (PPO output) write operation to the MEMOBUS/Modbus register.	0	858
F7-64 (0784)	PZD5 Write	<b>V/f</b> <b>CL-V/f</b> <b>OLV</b> <b>CLV</b> <b>AOLV</b> <b>OLV/PM</b> <b>AOLV/PM</b> <b>CLV/PM</b> <b>EZOLV</b> Sets the MEMOBUS/Modbus address for PZD5 (PPO output). A value of 0, 1, or 2 will disable the PZD5 (PPO output) write operation to the MEMOBUS/Modbus register.	0	859
F7-65 (0785)	PZD6 Write	<b>V/f</b> <b>CL-V/f</b> <b>OLV</b> <b>CLV</b> <b>AOLV</b> <b>OLV/PM</b> <b>AOLV/PM</b> <b>CLV/PM</b> <b>EZOLV</b> Sets the MEMOBUS/Modbus address for PZD6 (PPO output). A value of 0, 1, or 2 will disable the PZD6 (PPO output) write operation to the MEMOBUS/Modbus register.	0	859
F7-66 (0786)	PZD7 Write	<b>V/f</b> <b>CL-V/f</b> <b>OLV</b> <b>CLV</b> <b>AOLV</b> <b>OLV/PM</b> <b>AOLV/PM</b> <b>CLV/PM</b> <b>EZOLV</b> Sets the MEMOBUS/Modbus address for PZD7 (PPO output). A value of 0, 1, or 2 will disable the PZD7 (PPO output) write operation to the MEMOBUS/Modbus register.	0	859
F7-67 (0787)	PZD8 Write	<b>V/f</b> <b>CL-V/f</b> <b>OLV</b> <b>CLV</b> <b>AOLV</b> <b>OLV/PM</b> <b>AOLV/PM</b> <b>CLV/PM</b> <b>EZOLV</b> Sets the MEMOBUS/Modbus address for PZD8 (PPO output). A value of 0, 1, or 2 will disable the PZD8 (PPO output) write operation to the MEMOBUS/Modbus register.	0	859
F7-68 (0788)	PZD9 Write	<b>V/f</b> <b>CL-V/f</b> <b>OLV</b> <b>CLV</b> <b>AOLV</b> <b>OLV/PM</b> <b>AOLV/PM</b> <b>CLV/PM</b> <b>EZOLV</b> Sets the MEMOBUS/Modbus address for PZD9 (PPO output). A value of 0, 1, or 2 will disable the PZD9 (PPO output) write operation to the MEMOBUS/Modbus register.	0	859
F7-69 (0789)	PZD10 Write	<b>V/f</b> <b>CL-V/f</b> <b>OLV</b> <b>CLV</b> <b>AOLV</b> <b>OLV/PM</b> <b>AOLV/PM</b> <b>CLV/PM</b> <b>EZOLV</b> Sets the MEMOBUS/Modbus address for PZD10 (PPO output). A value of 0, 1, or 2 will disable the PZD10 (PPO output) write operation to the MEMOBUS/Modbus register.	0	859
F7-70 (078A)	PZD1 Read (Status Word)	<b>V/f</b> <b>CL-V/f</b> <b>OLV</b> <b>CLV</b> <b>AOLV</b> <b>OLV/PM</b> <b>AOLV/PM</b> <b>CLV/PM</b> <b>EZOLV</b> Sets the MEMOBUS/Modbus address for PZD1 (PPO Read). PZD1 (PPO input) functions as the ZSW when $F7-70 = 0$ .	0	859
F7-71 (078B)	PZD2 Read (Output Frequency)	<b>V/f</b> <b>CL-V/f</b> <b>OLV</b> <b>CLV</b> <b>AOLV</b> <b>OLV/PM</b> <b>AOLV/PM</b> <b>CLV/PM</b> <b>EZOLV</b> Sets the MEMOBUS/Modbus address for PZD2 (PPO Read). PZD2 (PPO input) functions as the HIW when $F7-71 = 0$ .	0	860
F7-72 (078C)	PZD3 Read	<b>V/f</b> <b>CL-V/f</b> <b>OLV</b> <b>CLV</b> <b>AOLV</b> <b>OLV/PM</b> <b>AOLV/PM</b> <b>CLV/PM</b> <b>EZOLV</b> Sets the MEMOBUS/Modbus address for PZD3 (PPO Read). A value of 0 will disable the PZD3 (PPO input) load operation from the MEMOBUS/Modbus register.	0	860
F7-73 (078D)	PZD4 Read	<b>V/f</b> <b>CL-V/f</b> <b>OLV</b> <b>CLV</b> <b>AOLV</b> <b>OLV/PM</b> <b>AOLV/PM</b> <b>CLV/PM</b> <b>EZOLV</b> Sets the MEMOBUS/Modbus address for PZD4 (PPO Read). A value of 0 will disable the PZD4 (PPO input) load operation from the MEMOBUS/Modbus register.	0	860
F7-74 (078E)	PZD5 Read	<b>V/f</b> <b>CL-V/f</b> <b>OLV</b> <b>CLV</b> <b>AOLV</b> <b>OLV/PM</b> <b>AOLV/PM</b> <b>CLV/PM</b> <b>EZOLV</b> Sets the MEMOBUS/Modbus address for PZD5 (PPO Read). A value of 0 will disable the PZD5 (PPO input) load operation from the MEMOBUS/Modbus register.	0	860
F7-75 (078F)	PZD6 Read	<b>V/f</b> <b>CL-V/f</b> <b>OLV</b> <b>CLV</b> <b>AOLV</b> <b>OLV/PM</b> <b>AOLV/PM</b> <b>CLV/PM</b> <b>EZOLV</b> Sets the MEMOBUS/Modbus address for PZD6 (PPO Read). A value of 0 will disable the PZD6 (PPO input) load operation from the MEMOBUS/Modbus register.	0	860
F7-76 (0790)	PZD7 Read	<b>V/f</b> <b>CL-V/f</b> <b>OLV</b> <b>CLV</b> <b>AOLV</b> <b>OLV/PM</b> <b>AOLV/PM</b> <b>CLV/PM</b> <b>EZOLV</b> Sets the MEMOBUS/Modbus address for PZD7 (PPO Read). A value of 0 will disable the PZD7 (PPO input) load operation from the MEMOBUS/Modbus register.	0	860
F7-77 (0791)	PZD8 Read	<b>V/f</b> <b>CL-V/f</b> <b>OLV</b> <b>CLV</b> <b>AOLV</b> <b>OLV/PM</b> <b>AOLV/PM</b> <b>CLV/PM</b> <b>EZOLV</b> Sets the MEMOBUS/Modbus address for PZD8 (PPO Read). A value of 0 will disable the PZD8 (PPO input) load operation from the MEMOBUS/Modbus register.	0	860



No. (Hex.)	Name	Description	Default (Range)	Ref.
F7-78 (0792)	PZD9 Read	<p><b>V/f</b> <b>CL-V/f</b> <b>OLV</b> <b>CLV</b> <b>AOLV</b> <b>OLV/PM</b> <b>AOLV/PM</b> <b>CLV/PM</b> <b>EZOLV</b></p> <p>Sets the MEMOBUS/Modbus address for PZD9 (PPO Read). A value of 0 will disable the PZD9 (PPO input) load operation from the MEMOBUS/Modbus register.</p>	0	861
F7-79 (0793)	PZD10 Read	<p><b>V/f</b> <b>CL-V/f</b> <b>OLV</b> <b>CLV</b> <b>AOLV</b> <b>OLV/PM</b> <b>AOLV/PM</b> <b>CLV/PM</b> <b>EZOLV</b></p> <p>Sets the MEMOBUS/Modbus address for PZD10 (PPO Read). A value of 0 will disable the PZD10 (PPO input) load operation from the MEMOBUS/Modbus register.</p>	0	861

## 10.10 H: Terminal Functions

### ◆ H1: Digital Inputs

No. (Hex.)	Name	Description	Default (Range)	Ref.
H1-01 (0438)	Terminal S1 Function Selection	<p><b>V/f</b> <b>CL-V/f</b> <b>OLV</b> <b>CLV</b> <b>AOLV</b> <b>OLV/PM</b> <b>AOLV/PM</b> <b>CLV/PM</b> <b>EZOLV</b></p> Sets the function for MFDI terminal S1. <b>Note:</b> The default setting is <i>F</i> when the drive is initialized for <i>3-Wire Initialization</i> [ <i>A1-03 = 3330</i> ].	40 (1-19F)	863
H1-02 (0439)	Terminal S2 Function Selection	<p><b>V/f</b> <b>CL-V/f</b> <b>OLV</b> <b>CLV</b> <b>AOLV</b> <b>OLV/PM</b> <b>AOLV/PM</b> <b>CLV/PM</b> <b>EZOLV</b></p> Sets the function for MFDI terminal S2. <b>Note:</b> The default setting is <i>F</i> when the drive is initialized for <i>3-Wire Initialization</i> [ <i>A1-03 = 3330</i> ].	41 (1 - 19F)	863
H1-03 (0400)	Terminal S3 Function Selection	<p><b>V/f</b> <b>CL-V/f</b> <b>OLV</b> <b>CLV</b> <b>AOLV</b> <b>OLV/PM</b> <b>AOLV/PM</b> <b>CLV/PM</b> <b>EZOLV</b></p> Sets the function for MFDI terminal S3.	24 (0 - 19F)	863
H1-04 (0401)	Terminal S4 Function Selection	<p><b>V/f</b> <b>CL-V/f</b> <b>OLV</b> <b>CLV</b> <b>AOLV</b> <b>OLV/PM</b> <b>AOLV/PM</b> <b>CLV/PM</b> <b>EZOLV</b></p> Sets the function for MFDI terminal S4.	14 (0 - 19F)	863
H1-05 (0402)	Terminal S5 Function Selection	<p><b>V/f</b> <b>CL-V/f</b> <b>OLV</b> <b>CLV</b> <b>AOLV</b> <b>OLV/PM</b> <b>AOLV/PM</b> <b>CLV/PM</b> <b>EZOLV</b></p> Sets the function for MFDI terminal S5. <b>Note:</b> The default setting is <i>0</i> when the drive is initialized for <i>3-Wire Initialization</i> [ <i>A1-03 = 3330</i> ].	3 (0 - 19F)	864
H1-06 (0403)	Terminal S6 Function Selection	<p><b>V/f</b> <b>CL-V/f</b> <b>OLV</b> <b>CLV</b> <b>AOLV</b> <b>OLV/PM</b> <b>AOLV/PM</b> <b>CLV/PM</b> <b>EZOLV</b></p> Sets the function for MFDI terminal S6. <b>Note:</b> The default setting is <i>3</i> when the drive is initialized for <i>3-Wire Initialization</i> [ <i>A1-03 = 3330</i> ].	4 (0 - 19F)	864
H1-07 (0404)	Terminal S7 Function Selection	<p><b>V/f</b> <b>CL-V/f</b> <b>OLV</b> <b>CLV</b> <b>AOLV</b> <b>OLV/PM</b> <b>AOLV/PM</b> <b>CLV/PM</b> <b>EZOLV</b></p> Sets the function for MFDI terminal S7. <b>Note:</b> The default setting is <i>4</i> when the drive is initialized for <i>3-Wire Initialization</i> [ <i>A1-03 = 3330</i> ].	6 (0 - 19F)	864
H1-08 (0405)	Terminal S8 Function Selection	<p><b>V/f</b> <b>CL-V/f</b> <b>OLV</b> <b>CLV</b> <b>AOLV</b> <b>OLV/PM</b> <b>AOLV/PM</b> <b>CLV/PM</b> <b>EZOLV</b></p> Sets the function for MFDI terminal S8.	8 (0 - 19F)	864
H1-21 (0B70)	Terminal S1 Function Select 2	<p><b>V/f</b> <b>CL-V/f</b> <b>OLV</b> <b>CLV</b> <b>AOLV</b> <b>OLV/PM</b> <b>AOLV/PM</b> <b>CLV/PM</b> <b>EZOLV</b></p> Sets the second function for MFDI terminal S1.	F (1 - 19F)	864
H1-22 (0B71)	Terminal S2 Function Select 2	<p><b>V/f</b> <b>CL-V/f</b> <b>OLV</b> <b>CLV</b> <b>AOLV</b> <b>OLV/PM</b> <b>AOLV/PM</b> <b>CLV/PM</b> <b>EZOLV</b></p> Sets the second function for MFDI terminal S2.	F (1 - 19F)	864
H1-23 (0B72)	Terminal S3 Function Select 2	<p><b>V/f</b> <b>CL-V/f</b> <b>OLV</b> <b>CLV</b> <b>AOLV</b> <b>OLV/PM</b> <b>AOLV/PM</b> <b>CLV/PM</b> <b>EZOLV</b></p> Sets the second function for MFDI terminal S3.	F (1 - 19F)	865
H1-24 (0B73)	Terminal S4 Function Select 2	<p><b>V/f</b> <b>CL-V/f</b> <b>OLV</b> <b>CLV</b> <b>AOLV</b> <b>OLV/PM</b> <b>AOLV/PM</b> <b>CLV/PM</b> <b>EZOLV</b></p> Sets the second function for MFDI terminal S4.	F (1 - 19F)	865
H1-25 (0B74)	Terminal S5 Function Select 2	<p><b>V/f</b> <b>CL-V/f</b> <b>OLV</b> <b>CLV</b> <b>AOLV</b> <b>OLV/PM</b> <b>AOLV/PM</b> <b>CLV/PM</b> <b>EZOLV</b></p> Sets the second function for MFDI terminal S5.	F (1 - 19F)	865
H1-26 (0B75)	Terminal S6 Function Select 2	<p><b>V/f</b> <b>CL-V/f</b> <b>OLV</b> <b>CLV</b> <b>AOLV</b> <b>OLV/PM</b> <b>AOLV/PM</b> <b>CLV/PM</b> <b>EZOLV</b></p> Sets the second function for MFDI terminal S6.	F (1 - 19F)	865
H1-27 (0B76)	Terminal S7 Function Select 2	<p><b>V/f</b> <b>CL-V/f</b> <b>OLV</b> <b>CLV</b> <b>AOLV</b> <b>OLV/PM</b> <b>AOLV/PM</b> <b>CLV/PM</b> <b>EZOLV</b></p> Sets the second function for MFDI terminal S7.	F (1 - 19F)	865
H1-28 (0B77)	Terminal S8 Function Select 2	<p><b>V/f</b> <b>CL-V/f</b> <b>OLV</b> <b>CLV</b> <b>AOLV</b> <b>OLV/PM</b> <b>AOLV/PM</b> <b>CLV/PM</b> <b>EZOLV</b></p> Sets the second function for MFDI terminal S8.	F (1 - 19F)	865
H1-40 (0B54)	Mbus Reg 15C0h bit0 Input Func	<p><b>V/f</b> <b>CL-V/f</b> <b>OLV</b> <b>CLV</b> <b>AOLV</b> <b>OLV/PM</b> <b>AOLV/PM</b> <b>CLV/PM</b> <b>EZOLV</b></p> Sets the MFDI function for <i>bit 0</i> of MEMOBUS/Modbus register <i>15C0 (Hex.)</i> .	F (1 - 19F)	866

No. (Hex.)	Name	Description	Default (Range)	Ref.
H1-41 (0B55)	Mbus Reg 15C0h bit1 Input Func	<b>V/f</b> <b>CL-V/f</b> <b>OLV</b> <b>CLV</b> <b>AOLV</b> <b>OLV/PM</b> <b>AOLV/PM</b> <b>CLV/PM</b> <b>EZOLV</b> Sets the MFDI function for <i>bit 1</i> of MEMOBUS/Modbus register <i>15C0 (Hex.)</i> .	F (1 - 19F)	866
H1-42 (0B56)	Mbus Reg 15C0h bit2 Input Func	<b>V/f</b> <b>CL-V/f</b> <b>OLV</b> <b>CLV</b> <b>AOLV</b> <b>OLV/PM</b> <b>AOLV/PM</b> <b>CLV/PM</b> <b>EZOLV</b> Sets the MFDI function for <i>bit 2</i> of MEMOBUS/Modbus register <i>15C0 (Hex.)</i> .	F (1 - 19F)	866

### ■ H1-xx: Multi-Function Digital Input Setting Values

Setting	Function	Description	Ref.
0	3-Wire Sequence	<b>V/f</b> <b>CL-V/f</b> <b>OLV</b> <b>CLV</b> <b>AOLV</b> <b>OLV/PM</b> <b>AOLV/PM</b> <b>CLV/PM</b> <b>EZOLV</b> Sets the direction of motor rotation for 3-wire sequence.	866
1	LOCAL/REMOTE Selection	<b>V/f</b> <b>CL-V/f</b> <b>OLV</b> <b>CLV</b> <b>AOLV</b> <b>OLV/PM</b> <b>AOLV/PM</b> <b>CLV/PM</b> <b>EZOLV</b> Sets drive control for the keypad (LOCAL) or an external source (REMOTE). ON : LOCAL OFF : REMOTE	867
2	External Reference 1/2 Selection	<b>V/f</b> <b>CL-V/f</b> <b>OLV</b> <b>CLV</b> <b>AOLV</b> <b>OLV/PM</b> <b>AOLV/PM</b> <b>CLV/PM</b> <b>EZOLV</b> Sets the drive to use Run command source 1/2 or Reference command source 1/2 when in REMOTE Mode. ON : <i>b1-15 = [Frequency Reference Selection 2], b1-16 [Run Command Selection 2]</i> OFF : <i>b1-01 = [Frequency Reference Selection 1], b1-02 [Run Command Selection 1]</i>	868
3	Multi-Step Speed Reference 1	<b>V/f</b> <b>CL-V/f</b> <b>OLV</b> <b>CLV</b> <b>AOLV</b> <b>OLV/PM</b> <b>AOLV/PM</b> <b>CLV/PM</b> <b>EZOLV</b> Uses speed references <i>d1-01 to d1-08 [Multi-Step Speed Reference]</i> to set a multi-step speed reference.	868
4	Multi-Step Speed Reference 2	<b>V/f</b> <b>CL-V/f</b> <b>OLV</b> <b>CLV</b> <b>AOLV</b> <b>OLV/PM</b> <b>AOLV/PM</b> <b>CLV/PM</b> <b>EZOLV</b> Uses speed references <i>d1-01 to d1-08 [Multi-Step Speed Reference]</i> to set a multi-step speed reference.	868
5	Multi-Step Speed Reference 3	<b>V/f</b> <b>CL-V/f</b> <b>OLV</b> <b>CLV</b> <b>AOLV</b> <b>OLV/PM</b> <b>AOLV/PM</b> <b>CLV/PM</b> <b>EZOLV</b> Uses speed references <i>d1-01 to d1-08 [Multi-Step Speed Reference]</i> to set a multi-step speed reference.	868
6	Jog Reference Selection	<b>V/f</b> <b>CL-V/f</b> <b>OLV</b> <b>CLV</b> <b>AOLV</b> <b>OLV/PM</b> <b>AOLV/PM</b> <b>CLV/PM</b> <b>EZOLV</b> Sets the drive to use the JOG Frequency Reference (JOG command) set in <i>d1-17</i> . The JOG Frequency Reference (JOG command) overrides Frequency References 1 to 16 ( <i>d1-01 to d1-16</i> ).	868
7	Accel/Decel Time Selection 1	<b>V/f</b> <b>CL-V/f</b> <b>OLV</b> <b>CLV</b> <b>AOLV</b> <b>OLV/PM</b> <b>AOLV/PM</b> <b>CLV/PM</b> <b>EZOLV</b> Sets the drive to use <i>Acceleration/Deceleration Time 1 [C1-01, C1-02]</i> or <i>Acceleration/Deceleration Time 2 [C1-03, C1-04]</i> .	868
8	Baseblock Command (N.O.)	<b>V/f</b> <b>CL-V/f</b> <b>OLV</b> <b>CLV</b> <b>AOLV</b> <b>OLV/PM</b> <b>AOLV/PM</b> <b>CLV/PM</b> <b>EZOLV</b> Sets the command that stops drive output and coasts the motor to stop when the input is ON. ON : Baseblock (drive output stop) OFF : Normal operation	868
9	Baseblock Command (N.C.)	<b>V/f</b> <b>CL-V/f</b> <b>OLV</b> <b>CLV</b> <b>AOLV</b> <b>OLV/PM</b> <b>AOLV/PM</b> <b>CLV/PM</b> <b>EZOLV</b> Sets the command that stops drive output and coasts the motor to stop when the input terminal is OFF. ON : Normal operation OFF : Baseblock (drive output stop)	869
A	Accel/Decel Ramp Hold	<b>V/f</b> <b>CL-V/f</b> <b>OLV</b> <b>CLV</b> <b>AOLV</b> <b>OLV/PM</b> <b>AOLV/PM</b> <b>CLV/PM</b> <b>EZOLV</b> Momentarily pauses motor acceleration and deceleration when the terminal is turned ON, retains the output frequency that was stored in the drive at the time of the pause, and restarts motor operation.	869
B	Overheat Alarm (oH2)	<b>V/f</b> <b>CL-V/f</b> <b>OLV</b> <b>CLV</b> <b>AOLV</b> <b>OLV/PM</b> <b>AOLV/PM</b> <b>CLV/PM</b> <b>EZOLV</b> Sets the drive to display an <i>oH2 [Drive Overheat Warning]</i> alarm when the input terminal is ON. The alarm does not have an effect on drive operation.	869
C	Analog Terminal Enable Selection	<b>V/f</b> <b>CL-V/f</b> <b>OLV</b> <b>CLV</b> <b>AOLV</b> <b>OLV/PM</b> <b>AOLV/PM</b> <b>CLV/PM</b> <b>EZOLV</b> Sets the command that enables or disables the terminals selected in <i>H3-14 [Analog Input Terminal Enable Sel]</i> . ON : Input to the terminal selected with <i>H3-14</i> is enabled OFF : Input to the terminal selected with <i>H3-14</i> is disabled	870

## 10.10 H: Terminal Functions

Setting	Function	Description	Ref.
D	Ignore Speed Fdbk (V/f w/o Enc)	<p>V/f <input type="checkbox"/> CL-V/f <input type="checkbox"/> OLV <input type="checkbox"/> CLV <input type="checkbox"/> AOLV <input type="checkbox"/> OLV/PM <input type="checkbox"/> AOLV/PM <input type="checkbox"/> CLV/PM <input type="checkbox"/> EZOLV</p> <p>Sets the command to disable speed feedback control and run the drive in V/f control or use speed feedback from the encoder.            ON : Speed feedback control disable (V/f Control)            OFF : Speed feedback control enable (Closed Loop V/f Control)</p>	870
E	ASR Integral Reset	<p>V/f <input type="checkbox"/> CL-V/f <input type="checkbox"/> OLV <input type="checkbox"/> CLV <input type="checkbox"/> AOLV <input type="checkbox"/> OLV/PM <input type="checkbox"/> AOLV/PM <input type="checkbox"/> CLV/PM <input type="checkbox"/> EZOLV</p> <p>Sets the command to reset the integral value and use PI control or P control for the speed control loop.            ON : P control            OFF : PI control</p>	870
F	Not Used	<p>V/f <input type="checkbox"/> CL-V/f <input type="checkbox"/> OLV <input type="checkbox"/> CLV <input type="checkbox"/> AOLV <input type="checkbox"/> OLV/PM <input type="checkbox"/> AOLV/PM <input type="checkbox"/> CLV/PM <input type="checkbox"/> EZOLV</p> <p>Setting for terminals that are not being used or terminals being used in through mode.</p>	870
10	Up Command	<p>V/f <input type="checkbox"/> CL-V/f <input type="checkbox"/> OLV <input type="checkbox"/> CLV <input type="checkbox"/> AOLV <input type="checkbox"/> OLV/PM <input type="checkbox"/> AOLV/PM <input type="checkbox"/> CLV/PM <input type="checkbox"/> EZOLV</p> <p>Sets the command to use a button to increase the drive frequency reference. You must also set Setting 11 [Down Command].            ON : Increases the frequency reference.            OFF : Holds the current frequency reference.</p>	870
11	Down Command	<p>V/f <input type="checkbox"/> CL-V/f <input type="checkbox"/> OLV <input type="checkbox"/> CLV <input type="checkbox"/> AOLV <input type="checkbox"/> OLV/PM <input type="checkbox"/> AOLV/PM <input type="checkbox"/> CLV/PM <input type="checkbox"/> EZOLV</p> <p>Sets the command to decrease the drive frequency reference using a button. Users must also set Setting 10 [Up Command].            ON : Decreases the frequency reference.            OFF : Holds the current frequency reference.</p>	872
12	Forward Jog	<p>V/f <input type="checkbox"/> CL-V/f <input type="checkbox"/> OLV <input type="checkbox"/> CLV <input type="checkbox"/> AOLV <input type="checkbox"/> OLV/PM <input type="checkbox"/> AOLV/PM <input type="checkbox"/> CLV/PM <input type="checkbox"/> EZOLV</p> <p>Sets the command to operate the motor in the forward direction at the Jog Frequency set in d1-17 [Jog Reference].</p>	872
13	Reverse Jog	<p>V/f <input type="checkbox"/> CL-V/f <input type="checkbox"/> OLV <input type="checkbox"/> CLV <input type="checkbox"/> AOLV <input type="checkbox"/> OLV/PM <input type="checkbox"/> AOLV/PM <input type="checkbox"/> CLV/PM <input type="checkbox"/> EZOLV</p> <p>Sets the command to operate the motor in the reverse direction at the Jog Frequency set in d1-17 [Jog Reference].</p>	873
14	Fault Reset	<p>V/f <input type="checkbox"/> CL-V/f <input type="checkbox"/> OLV <input type="checkbox"/> CLV <input type="checkbox"/> AOLV <input type="checkbox"/> OLV/PM <input type="checkbox"/> AOLV/PM <input type="checkbox"/> CLV/PM <input type="checkbox"/> EZOLV</p> <p>Sets the command to reset the current fault when the Run command is inactive.  <b>Note:</b>            The drive ignores the fault reset command when the Run command is active. Remove the Run command before trying to reset a fault.</p>	873
15	Fast Stop (N.O.)	<p>V/f <input type="checkbox"/> CL-V/f <input type="checkbox"/> OLV <input type="checkbox"/> CLV <input type="checkbox"/> AOLV <input type="checkbox"/> OLV/PM <input type="checkbox"/> AOLV/PM <input type="checkbox"/> CLV/PM <input type="checkbox"/> EZOLV</p> <p>Sets the command to ramp to stop in the deceleration time set in C1-09 [Fast Stop Time] when the input terminal is ON while the drive is operating.</p>	873
16	Motor 2 Selection	<p>V/f <input type="checkbox"/> CL-V/f <input type="checkbox"/> OLV <input type="checkbox"/> CLV <input type="checkbox"/> AOLV <input type="checkbox"/> OLV/PM <input type="checkbox"/> AOLV/PM <input type="checkbox"/> CLV/PM <input type="checkbox"/> EZOLV</p> <p>Sets the command for the drive to operate motor 1 or motor 2. Stop the motors before switching.            ON : Operate motor 2            OFF : Operate motor 1</p>	873
17	Fast Stop (N.C.)	<p>V/f <input type="checkbox"/> CL-V/f <input type="checkbox"/> OLV <input type="checkbox"/> CLV <input type="checkbox"/> AOLV <input type="checkbox"/> OLV/PM <input type="checkbox"/> AOLV/PM <input type="checkbox"/> CLV/PM <input type="checkbox"/> EZOLV</p> <p>Sets the command to ramp to stop in the deceleration time set in C1-09 [Fast Stop Time] when the input terminal is ON while the drive is operating.</p>	874
18	Timer Function	<p>V/f <input type="checkbox"/> CL-V/f <input type="checkbox"/> OLV <input type="checkbox"/> CLV <input type="checkbox"/> AOLV <input type="checkbox"/> OLV/PM <input type="checkbox"/> AOLV/PM <input type="checkbox"/> CLV/PM <input type="checkbox"/> EZOLV</p> <p>Sets the command to start the timer function. Use this setting with <i>Timer Output</i> [H2-xx = 12].</p>	875
19	PID Disable	<p>V/f <input type="checkbox"/> CL-V/f <input type="checkbox"/> OLV <input type="checkbox"/> CLV <input type="checkbox"/> AOLV <input type="checkbox"/> OLV/PM <input type="checkbox"/> AOLV/PM <input type="checkbox"/> CLV/PM <input type="checkbox"/> EZOLV</p> <p>Sets the command to disable PID control when b5-01 = 1 to 8 [PID Mode Setting = Enabled].            ON : PID control disabled            OFF : PID control enabled</p>	875
1A	Accel/Decel Time Selection 2	<p>V/f <input type="checkbox"/> CL-V/f <input type="checkbox"/> OLV <input type="checkbox"/> CLV <input type="checkbox"/> AOLV <input type="checkbox"/> OLV/PM <input type="checkbox"/> AOLV/PM <input type="checkbox"/> CLV/PM <input type="checkbox"/> EZOLV</p> <p>Set this function and H1-xx = 7 [Accel/dec el Time Selection 1] together. Sets the drive to use <i>Acceleration/Deceleration Time 3</i> [C1-05, C1-06] or <i>Acceleration/Deceleration Time 4</i> [C1-07, C1-08].</p>	875
1B	Programming Lockout	<p>V/f <input type="checkbox"/> CL-V/f <input type="checkbox"/> OLV <input type="checkbox"/> CLV <input type="checkbox"/> AOLV <input type="checkbox"/> OLV/PM <input type="checkbox"/> AOLV/PM <input type="checkbox"/> CLV/PM <input type="checkbox"/> EZOLV</p> <p>Sets the command to prevent parameter changes when the terminal is OFF.            ON : Program Lockout            OFF : Parameter Write Prohibit</p>	875

Setting	Function	Description	Ref.
1E	Reference Sample Hold	<b>V/f</b> <b>CL-V/f</b> <b>OLV</b> <b>CLV</b> <b>AOLV</b> <b>OLV/PM</b> <b>AOLV/PM</b> <b>CLV/PM</b> <b>EZOLV</b> Sets the command to sample the frequency reference at terminals A1, A2, or A3 and hold the frequency reference at that frequency.	875
20 to 2F	External Fault	<b>V/f</b> <b>CL-V/f</b> <b>OLV</b> <b>CLV</b> <b>AOLV</b> <b>OLV/PM</b> <b>AOLV/PM</b> <b>CLV/PM</b> <b>EZOLV</b> Sets a command to stop the drive when a failure or fault occurs on an external device. 20 : External Fault (NO-Always-Ramp) 21 : External Fault (NC-Always-Ramp) 22 : External Fault (NO-@Run-Ramp) 23 : External Fault (NC-@Run-Ramp) 24 : External Fault (NO-Always-Coast) 25 : External Fault (NC-Always-Coast) 26 : External Fault (NO-@Run-Coast) 27 : External Fault (NC-@Run-Coast) 28 : External Fault (NO-Always-FStop) 29 : External Fault (NC-Always-FStop) 2A : External Fault (NO-@Run-FStop) 2B : External Fault (NC-@Run-FStop) 2C : External Fault (NO-Always-Alarm) 2D : External Fault (NC-Always-Alarm) 2E : External Fault (NO-@Run-Alarm) 2F : External Fault (NC-@Run-Alarm)	876
30	PID Integrator Reset	<b>V/f</b> <b>CL-V/f</b> <b>OLV</b> <b>CLV</b> <b>AOLV</b> <b>OLV/PM</b> <b>AOLV/PM</b> <b>CLV/PM</b> <b>EZOLV</b> Sets the command to reset and hold the PID control integral to 0 when the terminal is ON.	877
31	PID Integrator Hold	<b>V/f</b> <b>CL-V/f</b> <b>OLV</b> <b>CLV</b> <b>AOLV</b> <b>OLV/PM</b> <b>AOLV/PM</b> <b>CLV/PM</b> <b>EZOLV</b> Sets the command to hold the integral value of the PID control while the terminal is activated.	877
32	Multi-Step Speed Reference 4	<b>V/f</b> <b>CL-V/f</b> <b>OLV</b> <b>CLV</b> <b>AOLV</b> <b>OLV/PM</b> <b>AOLV/PM</b> <b>CLV/PM</b> <b>EZOLV</b> Sets the command to switch <i>d1-09 to d1-16 [Reference 9 to 16]</i> with multi-step speed references 1, 2 and 3.	877
34	PID Soft Starter Disable	<b>V/f</b> <b>CL-V/f</b> <b>OLV</b> <b>CLV</b> <b>AOLV</b> <b>OLV/PM</b> <b>AOLV/PM</b> <b>CLV/PM</b> <b>EZOLV</b> Sets the PID soft starter function. ON : Disabled OFF : Enabled	877
35	PID Input (Error) Invert	<b>V/f</b> <b>CL-V/f</b> <b>OLV</b> <b>CLV</b> <b>AOLV</b> <b>OLV/PM</b> <b>AOLV/PM</b> <b>CLV/PM</b> <b>EZOLV</b> Sets the command to turn the terminal ON and OFF to switch the PID input level (polarity).	877
3E	PID Setpoint Selection 1	<b>V/f</b> <b>CL-V/f</b> <b>OLV</b> <b>CLV</b> <b>AOLV</b> <b>OLV/PM</b> <b>AOLV/PM</b> <b>CLV/PM</b> <b>EZOLV</b> Set this function and <i>H1-xx = 3F [PID Setpoint Selection 2]</i> together. Sets the function to switch the PID setpoint to <i>b5-58 to b5-60 [PID Setpoint 2 to 4]</i> .	878
3F	PID Setpoint Selection 2	<b>V/f</b> <b>CL-V/f</b> <b>OLV</b> <b>CLV</b> <b>AOLV</b> <b>OLV/PM</b> <b>AOLV/PM</b> <b>CLV/PM</b> <b>EZOLV</b> Set this function and <i>H1-xx = 3E [PID Setpoint Selection 1]</i> together. Sets the function to switch the PID setpoint to <i>b5-58 to b5-60 [PID Setpoint 2 to 4]</i> .	878
40	Forward RUN (2-Wire)	<b>V/f</b> <b>CL-V/f</b> <b>OLV</b> <b>CLV</b> <b>AOLV</b> <b>OLV/PM</b> <b>AOLV/PM</b> <b>CLV/PM</b> <b>EZOLV</b> Sets the Forward Run command for 2-wire sequence 1. Set this function and <i>H1-xx = 41 [Reverse Run Command (2-Wire Seq)]</i> together. ON : Forward Run OFF : Run Stop <b>Note:</b> • Turning ON the Forward Run command terminal and the Reverse Run command terminal will cause alarm <i>EF [FWD/REV Run Command Input Error]</i> and the motor will ramp to stop. • Initialize the drive with a 2-wire sequence to set the Forward Run command to terminal S1. • This function will not operate at the same time as <i>H1-xx = 42, 43 [Run Command/ FWD/REV Command (2-Wire Seq 2)]</i> .	878

Setting	Function	Description	Ref.
41	Reverse RUN (2-Wire)	<p><b>V/f</b> <b>CL-V/f</b> <b>OLV</b> <b>CLV</b> <b>AOLV</b> <b>OLV/PM</b> <b>AOLV/PM</b> <b>CLV/PM</b> <b>EZOLV</b></p> <p>Sets the Reverse Run command for 2-wire sequence 1. Set this function and <math>H1-xx = 40</math> [Forward Run Command (2-Wire Seq)] together.</p> <p>ON : Reverse Run OFF : Run Stop</p> <p><b>Note:</b></p> <ul style="list-style-type: none"> <li>Turning ON the Forward Run command terminal and the Reverse Run command terminal will cause alarm EF [FWD/REV Run Command Input Error] and the motor will ramp to stop.</li> <li>Initialize the drive with a 2-wire sequence to set the Reverse Run command to terminal S2.</li> <li>This function will not operate at the same time as <math>H1-xx = 42, 43</math> [Run Command/ FWD/REV Command (2-Wire Seq 2)].</li> </ul>	878
42	Run Command (2-Wire Sequence 2)	<p><b>V/f</b> <b>CL-V/f</b> <b>OLV</b> <b>CLV</b> <b>AOLV</b> <b>OLV/PM</b> <b>AOLV/PM</b> <b>CLV/PM</b> <b>EZOLV</b></p> <p>Sets the Run command for 2-wire sequence 2. Set this function and <math>H1-xx = 43</math> [FWD/REV Command (2-Wire Seq 2)] together.</p> <p>ON : Run OFF : Stop</p> <p><b>Note:</b></p> <p>This function will not operate at the same time as <math>H1-xx = 40, 41</math> [Forward/Reverse Run Command (2-Wire Seq)].</p>	879
43	FWD/REV (2-Wire Sequence 2)	<p><b>V/f</b> <b>CL-V/f</b> <b>OLV</b> <b>CLV</b> <b>AOLV</b> <b>OLV/PM</b> <b>AOLV/PM</b> <b>CLV/PM</b> <b>EZOLV</b></p> <p>Sets the direction of motor rotation for 2-wire sequence 2. Set this function and <math>H1-xx = 42</math> [Run Command (2-Wire Sequence 2)] together.</p> <p>ON : Reverse OFF : Forward</p> <p><b>Note:</b></p> <p>This function will not operate at the same time as <math>H1-xx = 40, 41</math> [Forward/Reverse Run Command (2-Wire Seq)].</p>	879
44	Add Offset Frequency 1 (d7-01)	<p><b>V/f</b> <b>CL-V/f</b> <b>OLV</b> <b>CLV</b> <b>AOLV</b> <b>OLV/PM</b> <b>AOLV/PM</b> <b>CLV/PM</b> <b>EZOLV</b></p> <p>Sets the function to add the offset frequency set in <math>d7-01</math> [Offset Frequency 1] to the frequency reference when the terminal activates.</p>	879
45	Add Offset Frequency 2 (d7-02)	<p><b>V/f</b> <b>CL-V/f</b> <b>OLV</b> <b>CLV</b> <b>AOLV</b> <b>OLV/PM</b> <b>AOLV/PM</b> <b>CLV/PM</b> <b>EZOLV</b></p> <p>Sets the function to add the offset frequency set in <math>d7-02</math> [Offset Frequency 2] to the frequency reference when the terminal activates.</p>	879
46	Add Offset Frequency 3 (d7-03)	<p><b>V/f</b> <b>CL-V/f</b> <b>OLV</b> <b>CLV</b> <b>AOLV</b> <b>OLV/PM</b> <b>AOLV/PM</b> <b>CLV/PM</b> <b>EZOLV</b></p> <p>Sets the function to add the offset frequency set in <math>d7-03</math> [Offset Frequency 3] to the frequency reference when the terminal activates.</p>	879
47	Node Setup (CANopen)	<p><b>V/f</b> <b>CL-V/f</b> <b>OLV</b> <b>CLV</b> <b>AOLV</b> <b>OLV/PM</b> <b>AOLV/PM</b> <b>CLV/PM</b> <b>EZOLV</b></p> <p>Sets the function in CANopen communications to start the Node Setup function to set the drive node address from the host controller.</p>	879
60	DC Injection Braking Command	<p><b>V/f</b> <b>CL-V/f</b> <b>OLV</b> <b>CLV</b> <b>AOLV</b> <b>OLV/PM</b> <b>AOLV/PM</b> <b>CLV/PM</b> <b>EZOLV</b></p> <p>Sets the command to use DC Injection Braking to stop the motor.</p> <p><b>Note:</b></p> <p>When <math>A1-02 = 8</math> [Control Method Selection = EZ Open Loop Vector Control], this function is available if you use a PM motor.</p>	880
61	Speed Search from Fmax	<p><b>V/f</b> <b>CL-V/f</b> <b>OLV</b> <b>CLV</b> <b>AOLV</b> <b>OLV/PM</b> <b>AOLV/PM</b> <b>CLV/PM</b> <b>EZOLV</b></p> <p>Sets the function to start speed search using an external reference although <math>b3-01 = 0</math> [Speed Search Selection at Start = Disabled].</p> <p><b>Note:</b></p> <p>The drive will detect <math>oPE03</math> [Multi-Function Input Setting Err] when <math>H1-xx = 61</math> and <math>62</math> are set at the same time.</p>	880
62	Speed Search from Fref	<p><b>V/f</b> <b>CL-V/f</b> <b>OLV</b> <b>CLV</b> <b>AOLV</b> <b>OLV/PM</b> <b>AOLV/PM</b> <b>CLV/PM</b> <b>EZOLV</b></p> <p>Sets the function to start speed search using an external reference although <math>b3-01 = 0</math> [Speed Search Selection at Start = Disabled].</p> <p><b>Note:</b></p> <p>The drive will detect <math>oPE03</math> [Multi-Function Input Setting Err] when <math>H1-xx = 61</math> and <math>62</math> are set at the same time.</p>	880
63	Field Weakening	<p><b>V/f</b> <b>CL-V/f</b> <b>OLV</b> <b>CLV</b> <b>AOLV</b> <b>OLV/PM</b> <b>AOLV/PM</b> <b>CLV/PM</b> <b>EZOLV</b></p> <p>Sets the function to send the Field Weakening Level and Field Weakening Frequency Limit commands set in <math>d6-01</math> [Field Weakening Level] and <math>d6-02</math> [Field Weakening Frequency Limit] when the input terminal is activated.</p>	880

Setting	Function	Description	Ref.
65	KEB Ride-Thru 1 Activate (N.C.)	 Sets operation of the KEB1 function through the KEB Ride-Thru 1 (N.C.). ON : Normal operation OFF : Deceleration during momentary power loss	881
66	KEB Ride-Thru 1 Activate (N.O.)	 Sets operation of the KEB1 function through the KEB Ride-Thru 1 (N.O.). ON : Deceleration during momentary power loss OFF : Normal operation	881
67	Communications Test Mode	 Set the function for the drive to self-test RS-485 serial communications operation.	881
68	High Slip Braking (HSB) Activate	 Sets the command to use high-slip braking to stop the motor.	881
6A	Drive Enable	 Sets the function to show <i>dnE [Drive Enabled]</i> on the keypad and ignore Run commands when the terminal is OFF.	881
71	Torque Control	 Sets the function to switch between torque control and speed control. ON : Torque control OFF : Speed control	882
72	Zero Servo	 Sets the function to hold a stopped motor.	882
75	Up 2 Command	 Sets the function to increase the frequency reference bias value to accelerate the motor when the terminal is activated. Set this function and <i>H1-xx = 76 [Down 2 Command]</i> together. <b>Note:</b> When using this function, set the optimal bias limit value with <i>d4-08 and d4-09 [Up/Down 2 Bias Upper Limit/Lower Limit]</i> .	882
76	Down 2 Command	 Sets the function to increase the frequency reference bias value to accelerate the motor when the terminal is activated. Set this function and <i>H1-xx = 75 [Up 2 Command]</i> together. <b>Note:</b> When using this function, set the optimal bias limit value with <i>d4-08 and d4-09 [Up/Down 2 Bias Upper Limit/Lower Limit]</i> .	884
77	ASR Gain (C5-03) Select	 Sets the function to switch the ASR proportional gain set in <i>C5-01 [ASR Proportional Gain 1]</i> and <i>C5-03 [ASR Proportional Gain 1/2]</i> . ON : C5-03 OFF : C5-01	884
78	Analog TorqueRef Polarity Invert	 Sets the rotation direction of the external torque reference. ON : External torque reference reverse direction OFF : External torque reference forward direction	884
7A	KEB Ride-Thru 2 Activate (N.C.)	 Sets operation of the KEB2 function through the KEB Ride-Thru 2 (N.C.). ON : Normal operation OFF : Deceleration during momentary power loss	885
7B	KEB Ride-Thru 2 Activate (N.O.)	 Sets operation of the KEB2 function through the KEB Ride-Thru 2 (N.O.). ON : Deceleration during momentary power loss OFF : Normal operation	885
7C	Short Circuit Braking (N.O.)	 Sets operation of Short Circuit Braking (N.O.). ON : Short Circuit Braking is enabled. OFF : Normal operation <b>Note:</b> When <i>A1-02 = 8 [Control Method Selection = EZ Open Loop Vector Control]</i> , this function is available if you use a PM motor.	885

Setting	Function	Description	Ref.
7D	Short Circuit Braking (N.C.)	<p>V/f CL-V/f OLV CLV AOLV <b>OLV/PM</b> AOLV/PM CLV/PM <b>EZOLV</b></p> <p>Sets operation of Short Circuit Braking (N.C.).                      ON : Normal operation                      OFF : Short Circuit Braking is enabled.  <b>Note:</b>                      When <math>A1-02 = 8</math> [Control Method Selection = EZ Open Loop Vector Control], this function is available if you use a PM motor.</p>	885
7E	Reverse Rotation Identifier	<p>V/f CL-V/f OLV CLV AOLV <b>OLV/PM</b> AOLV/PM CLV/PM <b>EZOLV</b></p> <p>Sets the rotation direction of the motor when in Simple Closed Loop V/f Control method and <math>F1-21, F1-37 = 0</math> [Encoder Option Function Selection = A pulse detection], or when in Closed Loop V/f Control method.                      ON : Reverse                      OFF : Forward</p>	886
7F	PID Bi-Directional Enable	<p>V/f CL-V/f OLV CLV AOLV <b>OLV/PM</b> AOLV/PM CLV/PM <b>EZOLV</b></p> <p>Sets operation of the PID Bi-Directional function.                      ON : Enabled                      OFF : Disabled</p>	886
90 to 97	DriveWorksEZ Digital Inputs 1 to 8	<p>V/f CL-V/f OLV CLV AOLV <b>OLV/PM</b> AOLV/PM CLV/PM <b>EZOLV</b></p> <p>Sets digital inputs used with DriveWorksEZ. Refer to the DriveWorksEZ Online Manual for more information.</p>	886
9F	DWEZ Disable	<p>V/f CL-V/f OLV CLV AOLV <b>OLV/PM</b> AOLV/PM CLV/PM <b>EZOLV</b></p> <p>Sets operation of the DriveWorksEZ program saved in the drive.                      ON : Disabled                      OFF : Enabled  <b>Note:</b>                      Set <math>A1-07 = 2</math> [DriveWorksEZ Function Selection = Digital input] to use this function.</p>	886
101 to 19F	Inverse Input of 1 to 9F	<p>Sets the function of the selected MFDI to operate inversely. To select the function, enter "1xx", where the "xx" is the function setting value.  <b>Note:</b>                      You cannot use inverse input for all functions. Refer to <a href="#">Table 11.59</a> for more information.</p>	886

◆ H2: Digital Outputs

No. (Hex.)	Name	Description	Default (Range)	Ref.
H2-01 (040B)	Term M1-M2 Function Selection	<p>V/f CL-V/f OLV CLV AOLV <b>OLV/PM</b> AOLV/PM CLV/PM <b>EZOLV</b></p> <p>Sets the function for MFDO terminal M1-M2.  <b>Note:</b>                      Set this parameter to <math>F</math> when the terminal is not being used or to use the terminal in through mode.</p>	0 (0 - 1A7)	889
H2-02 (040C)	Term M3-M4 Function Selection	<p>V/f CL-V/f OLV CLV AOLV <b>OLV/PM</b> AOLV/PM CLV/PM <b>EZOLV</b></p> <p>Sets the function for MFDO terminal M3-M4.  <b>Note:</b>                      Set this parameter to <math>F</math> when the terminal is not being used or to use the terminal in through mode.</p>	1 (0 - 1A7)	889
H2-03 (040D)	Term M5-M6 Function Selection	<p>V/f CL-V/f OLV CLV AOLV <b>OLV/PM</b> AOLV/PM CLV/PM <b>EZOLV</b></p> <p>Sets the function for MFDO terminal M5-M6.  <b>Note:</b>                      Set this parameter to <math>F</math> when the terminal is not being used or to use the terminal in through mode.</p>	2 (0 - 1A7)	889



No. (Hex.)	Name	Description	Default (Range)	Ref.
H2-06 (0437)	Watt Hour Output Unit Selection	<b>V/f</b> <b>CL-V/f</b> <b>OLV</b> <b>CLV</b> <b>AOLV</b> <b>OLV/PM</b> <b>AOLV/PM</b> <b>CLV/PM</b> <b>EZOLV</b> Sets the unit for the output signal when H2-01 to H2-03 = 39 [MFDO Function Select = Watt Hour Pulse Output]. 0 : 0.1 kWh units 1 : 1 kWh units 2 : 10 kWh units 3 : 100 kWh units 4 : 1000 kWh units	0 (0 - 4)	889
H2-07 (0B3A)	Modbus Register 1 Address Select	<b>V/f</b> <b>CL-V/f</b> <b>OLV</b> <b>CLV</b> <b>AOLV</b> <b>OLV/PM</b> <b>AOLV/PM</b> <b>CLV/PM</b> <b>EZOLV</b> Sets the address of the MEMOBUS/Modbus register output to the MFDO terminal.	0001 (0001 - 1FFF)	890
H2-08 (0B3B)	Modbus Register 1 Bit Select	<b>V/f</b> <b>CL-V/f</b> <b>OLV</b> <b>CLV</b> <b>AOLV</b> <b>OLV/PM</b> <b>AOLV/PM</b> <b>CLV/PM</b> <b>EZOLV</b> Sets the bit of the MEMOBUS/Modbus register output to the MFDO terminal.	0000 (0000 - FFFF)	890
H2-09 (0B3C)	Modbus Register 2 Address Select	<b>V/f</b> <b>CL-V/f</b> <b>OLV</b> <b>CLV</b> <b>AOLV</b> <b>OLV/PM</b> <b>AOLV/PM</b> <b>CLV/PM</b> <b>EZOLV</b> Sets the address of the MEMOBUS/Modbus register output to the MFDO terminal.	0001 (0001 - 1FFF)	890
H2-10 (0B3D)	Modbus Register 2 Bit Select	<b>V/f</b> <b>CL-V/f</b> <b>OLV</b> <b>CLV</b> <b>AOLV</b> <b>OLV/PM</b> <b>AOLV/PM</b> <b>CLV/PM</b> <b>EZOLV</b> Sets the bit of the MEMOBUS/Modbus register output to the MFDO terminal.	0000 (0000 - FFFF)	890
H2-20 (1540)	Comparator 1 Monitor Selection	<b>V/f</b> <b>CL-V/f</b> <b>OLV</b> <b>CLV</b> <b>AOLV</b> <b>OLV/PM</b> <b>AOLV/PM</b> <b>CLV/PM</b> <b>EZOLV</b> Sets the monitor number for comparator 1. Set the x-xx part of the Ux-xx [Monitor]. For example, set x-xx to 102 to monitor U1-02 [Output Frequency].	102 (000 - 999)	890
H2-21 (1541)	Comparator 1 Lower Limit	<b>V/f</b> <b>CL-V/f</b> <b>OLV</b> <b>CLV</b> <b>AOLV</b> <b>OLV/PM</b> <b>AOLV/PM</b> <b>CLV/PM</b> <b>EZOLV</b> Sets the lower limit detection level for comparator 1 when the full scale analog output for the monitor selected in H2-20 [Comparator 1 Monitor Selection] is the 100% value.	0.0% (0.0 - 300.0%)	891
H2-22 (1542)	Comparator 1 Upper Limit	<b>V/f</b> <b>CL-V/f</b> <b>OLV</b> <b>CLV</b> <b>AOLV</b> <b>OLV/PM</b> <b>AOLV/PM</b> <b>CLV/PM</b> <b>EZOLV</b> Sets the upper limit detection level for comparator 1 when the full scale analog output for the monitor selected in H2-20 [Comparator 1 Monitor Selection] is the 100% value.	0.0% (0.0 - 300.0%)	891
H2-23 (1543)	Comparator 1 Hysteresis	<b>V/f</b> <b>CL-V/f</b> <b>OLV</b> <b>CLV</b> <b>AOLV</b> <b>OLV/PM</b> <b>AOLV/PM</b> <b>CLV/PM</b> <b>EZOLV</b> Sets the hysteresis level for comparator 1 when the full scale analog output for the monitor selected in H2-20 [Comparator 1 Monitor Selection] is the 100% value.	0.0% (0.0 - 10.0%)	891
H2-24 (1544)	Comparator 1 On-Delay Time	<b>V/f</b> <b>CL-V/f</b> <b>OLV</b> <b>CLV</b> <b>AOLV</b> <b>OLV/PM</b> <b>AOLV/PM</b> <b>CLV/PM</b> <b>EZOLV</b> Sets the on-delay time for comparator 1.	0.0 s (0.0 - 600.0 s)	891
H2-25 (1545)	Comparator 1 Off-Delay Time	<b>V/f</b> <b>CL-V/f</b> <b>OLV</b> <b>CLV</b> <b>AOLV</b> <b>OLV/PM</b> <b>AOLV/PM</b> <b>CLV/PM</b> <b>EZOLV</b> Sets the off-delay time for comparator 1.	0.0 s (0.0 - 600.0 s)	891
H2-26 (1546)	Comparator 2 Monitor Selection	<b>V/f</b> <b>CL-V/f</b> <b>OLV</b> <b>CLV</b> <b>AOLV</b> <b>OLV/PM</b> <b>AOLV/PM</b> <b>CLV/PM</b> <b>EZOLV</b> Sets the monitor number for comparator 2. Set the x-xx part of the Ux-xx [Monitor]. For example, set x-xx to 102 to monitor U1-02 [Output Frequency].	103 (000 - 999)	892
H2-27 (1547)	Comparator 2 Lower Limit	<b>V/f</b> <b>CL-V/f</b> <b>OLV</b> <b>CLV</b> <b>AOLV</b> <b>OLV/PM</b> <b>AOLV/PM</b> <b>CLV/PM</b> <b>EZOLV</b> Sets the lower limit detection level for comparator 1 when the full scale analog output for the monitor selected in H2-26 [Comparator 2 Monitor Selection] is the 100% value.	0.0% (0.0 - 300.0%)	892
H2-28 (1548)	Comparator 2 Upper Limit	<b>V/f</b> <b>CL-V/f</b> <b>OLV</b> <b>CLV</b> <b>AOLV</b> <b>OLV/PM</b> <b>AOLV/PM</b> <b>CLV/PM</b> <b>EZOLV</b> Sets the upper limit detection level for comparator 1 when the full scale analog output for the monitor selected in H2-26 [Comparator 2 Monitor Selection] is the 100% value.	0.0% (0.0 - 300.0%)	892
H2-29 (1549)	Comparator 2 Hysteresis	<b>V/f</b> <b>CL-V/f</b> <b>OLV</b> <b>CLV</b> <b>AOLV</b> <b>OLV/PM</b> <b>AOLV/PM</b> <b>CLV/PM</b> <b>EZOLV</b> Sets the hysteresis level for comparator 2 when the full scale analog output for the monitor selected in H2-26 [Comparator 2 Monitor Selection] is the 100% value.	0.0% (0.0 - 10.0%)	892
H2-30 (154A)	Comparator 2 On-Delay Time	<b>V/f</b> <b>CL-V/f</b> <b>OLV</b> <b>CLV</b> <b>AOLV</b> <b>OLV/PM</b> <b>AOLV/PM</b> <b>CLV/PM</b> <b>EZOLV</b> Sets the on-delay time for comparator 2.	0.0 s (0.0 - 600.0 s)	892

## 10.10 H: Terminal Functions

No. (Hex.)	Name	Description	Default (Range)	Ref.
H2-31 (154B)	Comparator 2 Off-Delay Time	<b>V/f</b> <b>CL-V/f</b> <b>OLV</b> <b>CLV</b> <b>AOLV</b> <b>OLV/PM</b> <b>AOLV/PM</b> <b>CLV/PM</b> <b>EZOLV</b> Sets the off-delay time for comparator 2.	0.0 s (0.0 - 600.0 s)	893
H2-32 (159A)	Comparator 1 Filter Time	<b>V/f</b> <b>CL-V/f</b> <b>OLV</b> <b>CLV</b> <b>AOLV</b> <b>OLV/PM</b> <b>AOLV/PM</b> <b>CLV/PM</b> <b>EZOLV</b> Sets the time constant that is applied to the primary delay filter used for the analog output of the monitor selected with H2-20 [Comparator 1 Monitor Selection].	0.0s (0.0 - 10.0 s)	893
H2-33 (159B)	Comparator1 Protection Selection	<b>V/f</b> <b>CL-V/f</b> <b>OLV</b> <b>CLV</b> <b>AOLV</b> <b>OLV/PM</b> <b>AOLV/PM</b> <b>CLV/PM</b> <b>EZOLV</b> Sets drive operation when it detects CP1 [Comparator1 Limit Fault]. 0 : Ramp to Stop 1 : Coast to Stop 2 : Fast Stop (Use C1-09) 3 : Alarm Only 4 : Digital Output Only	4 (0 - 4)	893
H2-34 (159C)	Comparator 2 Filter Time	<b>V/f</b> <b>CL-V/f</b> <b>OLV</b> <b>CLV</b> <b>AOLV</b> <b>OLV/PM</b> <b>AOLV/PM</b> <b>CLV/PM</b> <b>EZOLV</b> Sets the time constant that is applied to the primary delay filter used for the analog output of the monitor selected with H2-26 [Comparator 2 Monitor Selection].	0.0s (0.0 - 10.0 s)	893
H2-35 (159D)	Comparator2 Protection Selection	<b>V/f</b> <b>CL-V/f</b> <b>OLV</b> <b>CLV</b> <b>AOLV</b> <b>OLV/PM</b> <b>AOLV/PM</b> <b>CLV/PM</b> <b>EZOLV</b> Sets drive operation when it detects CP2 [Comparator2 Limit Fault]. 0 : Ramp to Stop 1 : Coast to Stop 2 : Fast Stop (Use C1-09) 3 : Alarm Only 4 : Digital Output Only	4 (0 - 4)	893
H2-36 (159E)	Comparator 1 Ineffective Time	<b>V/f</b> <b>CL-V/f</b> <b>OLV</b> <b>CLV</b> <b>AOLV</b> <b>OLV/PM</b> <b>AOLV/PM</b> <b>CLV/PM</b> <b>EZOLV</b> Sets the length of time that CP1 [Comparator1 Limit Fault] is disabled.	0.0 s (0.0 - 10.0 s)	894
H2-37 (159F)	Comparator 2 Ineffective Time	<b>V/f</b> <b>CL-V/f</b> <b>OLV</b> <b>CLV</b> <b>AOLV</b> <b>OLV/PM</b> <b>AOLV/PM</b> <b>CLV/PM</b> <b>EZOLV</b> Sets the length of time that CP2 [Comparator2 Limit Fault] is disabled.	0.0 s (0.0 - 10.0 s)	894
H2-40 (0B58)	Mbus Reg 15E0h bit0 Output Func	<b>V/f</b> <b>CL-V/f</b> <b>OLV</b> <b>CLV</b> <b>AOLV</b> <b>OLV/PM</b> <b>AOLV/PM</b> <b>CLV/PM</b> <b>EZOLV</b> Sets the MFDO for bit 0 of MEMOBUS register 15E0 (Hex.).	F (0 - 1A7)	894
H2-41 (0B59)	Mbus Reg 15E0h bit1 Output Func	<b>V/f</b> <b>CL-V/f</b> <b>OLV</b> <b>CLV</b> <b>AOLV</b> <b>OLV/PM</b> <b>AOLV/PM</b> <b>CLV/PM</b> <b>EZOLV</b> Sets the MFDO for bit 1 of MEMOBUS register 15E0 (Hex.).	F (0 - 1A7)	894
H2-42 (0B5A)	Mbus Reg 15E0h bit2 Output Func	<b>V/f</b> <b>CL-V/f</b> <b>OLV</b> <b>CLV</b> <b>AOLV</b> <b>OLV/PM</b> <b>AOLV/PM</b> <b>CLV/PM</b> <b>EZOLV</b> Sets the MFDO for bit 2 of MEMOBUS register 15E0 (Hex.).	F (0 - 1A7)	894
H2-60 (1B46) Expert	Term M1-M2 Secondary Function	<b>V/f</b> <b>CL-V/f</b> <b>OLV</b> <b>CLV</b> <b>AOLV</b> <b>OLV/PM</b> <b>AOLV/PM</b> <b>CLV/PM</b> <b>EZOLV</b> Selects the second function for terminal M1-M2. The logical calculation results of the terminals assigned to functions by H2-01 [Term M1-M2 Function Selection] is output.	F (0 - A7)	895
H2-61 (1B47) Expert	Terminal M1-M2 Logical Operation	<b>V/f</b> <b>CL-V/f</b> <b>OLV</b> <b>CLV</b> <b>AOLV</b> <b>OLV/PM</b> <b>AOLV/PM</b> <b>CLV/PM</b> <b>EZOLV</b> Sets the logical operation for the functions set in H2-01 [Term M1-M2 Function Selection] and H2-60 [Term M1-M2 Secondary Function].	0 (0 - 8)	895
H2-62 (1B48) Expert	Terminal M1-M2 Delay Time	<b>V/f</b> <b>CL-V/f</b> <b>OLV</b> <b>CLV</b> <b>AOLV</b> <b>OLV/PM</b> <b>AOLV/PM</b> <b>CLV/PM</b> <b>EZOLV</b> Sets the minimum on time used to output the logical calculation results from terminal M1-M2.	0.1 s (0.0 - 25.0 s)	895
H2-63 (1B49) Expert	Term M3-M4 Secondary Function	<b>V/f</b> <b>CL-V/f</b> <b>OLV</b> <b>CLV</b> <b>AOLV</b> <b>OLV/PM</b> <b>AOLV/PM</b> <b>CLV/PM</b> <b>EZOLV</b> Selects the second function for terminal M3-M4. The logical calculation results of the terminals assigned to functions by H2-02 [Term M3-M4 Function Selection] is output.	F (0 - A7)	895
H2-64 (1B4A) Expert	Terminal M3-M4 Logical Operation	<b>V/f</b> <b>CL-V/f</b> <b>OLV</b> <b>CLV</b> <b>AOLV</b> <b>OLV/PM</b> <b>AOLV/PM</b> <b>CLV/PM</b> <b>EZOLV</b> Sets the logical operation for the functions set in H2-02 [Term M3-M4 Function Selection] and H2-63 [Term M3-M4 Secondary Function].	0 (0 - 8)	895

No. (Hex.)	Name	Description	Default (Range)	Ref.
H2-65 (1B4B) Expert	Terminal M3-M4 Delay Time	<b>V/f</b> <b>CL-V/f</b> <b>OLV</b> <b>CLV</b> <b>AOLV</b> <b>OLV/PM</b> <b>AOLV/PM</b> <b>CLV/PM</b> <b>EZOLV</b> Sets the minimum on time used to output the logical calculation results from terminal M3-M4.	0.1 s (0.0 - 25.0 s)	895
H2-66 (1B4C) Expert	Term M5-M6 Secondary Function	<b>V/f</b> <b>CL-V/f</b> <b>OLV</b> <b>CLV</b> <b>AOLV</b> <b>OLV/PM</b> <b>AOLV/PM</b> <b>CLV/PM</b> <b>EZOLV</b> Selects the second function for terminal M5-M6. The logical calculation results of the terminals assigned to functions by H2-03 [Term M5-M6 Function Selection] is output.	F (0 - A7)	896
H2-67 (1B4D) Expert	Terminal M5-M6 Logical Operation	<b>V/f</b> <b>CL-V/f</b> <b>OLV</b> <b>CLV</b> <b>AOLV</b> <b>OLV/PM</b> <b>AOLV/PM</b> <b>CLV/PM</b> <b>EZOLV</b> Sets the logical operation for the functions set in H2-03 [Term M5-M6 Function Selection] and H2-66 [Term M5-M6 Secondary Function].	0 (0 - 8)	896
H2-68 (1B4E) Expert	Terminal M5-M6 Delay Time	<b>V/f</b> <b>CL-V/f</b> <b>OLV</b> <b>CLV</b> <b>AOLV</b> <b>OLV/PM</b> <b>AOLV/PM</b> <b>CLV/PM</b> <b>EZOLV</b> Sets the minimum on time used to output the logical calculation results from terminal M5-M6.	0.1 s (0.0 - 25.0 s)	896

■ H2-xx: MFDO Function Selections

Setting	Function	Description	Ref.																														
0	During Run	<b>V/f</b> <b>CL-V/f</b> <b>OLV</b> <b>CLV</b> <b>AOLV</b> <b>OLV/PM</b> <b>AOLV/PM</b> <b>CLV/PM</b> <b>EZOLV</b> The terminal activates when the Run command is input and when the drive is making voltage. ON : Drive is running OFF : Drive is stopping	896																														
1	Zero Speed	<b>V/f</b> <b>CL-V/f</b> <b>OLV</b> <b>CLV</b> <b>AOLV</b> <b>OLV/PM</b> <b>AOLV/PM</b> <b>CLV/PM</b> <b>EZOLV</b> The terminal activates when the output frequency is less than the value of E1-09 [Minimum Output Frequency] or b2-01 [DC Injection/Zero SpeedThreshold]. <b>Note:</b> A1-02 [Control Method Selection] selects which parameter is the reference. <table border="1" style="width: 100%; border-collapse: collapse;"> <thead> <tr> <th>A1-02 Setting</th> <th>Control Method</th> <th>Parameter Used as the Reference</th> </tr> </thead> <tbody> <tr><td>0</td><td>V/f</td><td>E1-09</td></tr> <tr><td>1</td><td>CL-V/f</td><td>E1-09</td></tr> <tr><td>2</td><td>OLV</td><td>b2-01</td></tr> <tr><td>3</td><td>CLV</td><td>E1-09</td></tr> <tr><td>4</td><td>AOLV</td><td>E1-09</td></tr> <tr><td>5</td><td>OLV/PM</td><td>E1-09</td></tr> <tr><td>6</td><td>AOLV/PM</td><td>E1-09</td></tr> <tr><td>7</td><td>CLV/PM</td><td>b2-01</td></tr> <tr><td>8</td><td>EZOLV</td><td>E1-09</td></tr> </tbody> </table> ON : Output frequency < value of E1-09 or b2-01. OFF : Output frequency ≥ value of E1-09 or b2-01.	A1-02 Setting	Control Method	Parameter Used as the Reference	0	V/f	E1-09	1	CL-V/f	E1-09	2	OLV	b2-01	3	CLV	E1-09	4	AOLV	E1-09	5	OLV/PM	E1-09	6	AOLV/PM	E1-09	7	CLV/PM	b2-01	8	EZOLV	E1-09	896
A1-02 Setting	Control Method	Parameter Used as the Reference																															
0	V/f	E1-09																															
1	CL-V/f	E1-09																															
2	OLV	b2-01																															
3	CLV	E1-09																															
4	AOLV	E1-09																															
5	OLV/PM	E1-09																															
6	AOLV/PM	E1-09																															
7	CLV/PM	b2-01																															
8	EZOLV	E1-09																															
2	Speed Agree 1	<b>V/f</b> <b>CL-V/f</b> <b>OLV</b> <b>CLV</b> <b>AOLV</b> <b>OLV/PM</b> <b>AOLV/PM</b> <b>CLV/PM</b> <b>EZOLV</b> The terminal turns on when the output frequency is in the range of the frequency reference ± L4-02 [Speed Agree Detection Width]. <b>Note:</b> The drive uses the motor speed as the reference in CLV. ON : The output frequency is in the range of “frequency reference ± L4-02.” OFF : The output frequency does not align with the frequency reference although the drive is running.	897																														

## 10.10 H: Terminal Functions

Setting	Function	Description	Ref.
3	User-Set Speed Agree 1	<p><b>V/f</b> <b>CL-V/f</b> <b>OLV</b> <b>CLV</b> <b>AOLV</b> <b>OLV/PM</b> <b>AOLV/PM</b> <b>CLV/PM</b> <b>EZOLV</b></p> <p>The terminal activates when the output frequency is in the range of <math>L4-01</math> [Speed Agree Detection Level] <math>\pm L4-02</math> [Speed Agree Detection Width] and in the range of frequency reference <math>\pm L4-02</math>.</p> <p><b>Note:</b></p> <ul style="list-style-type: none"> <li>The detection function operates in the two motor rotation directions.</li> <li>In CLV, the forward/reverse detection level is the value of "Motor Speed <math>\pm L4-02</math>."</li> </ul> <p>ON : The output frequency is in the range of "<math>L4-01 \pm L4-02</math>" and the range of frequency reference <math>\pm L4-02</math>.</p> <p>OFF : The output frequency is not in the range of "<math>L4-01 \pm L4-02</math>" or the in the range of frequency reference <math>\pm L4-02</math>.</p>	897
4	Frequency Detection 1	<p><b>V/f</b> <b>CL-V/f</b> <b>OLV</b> <b>CLV</b> <b>AOLV</b> <b>OLV/PM</b> <b>AOLV/PM</b> <b>CLV/PM</b> <b>EZOLV</b></p> <p>The terminal activates when the output frequency is higher than the value of <math>L4-01</math> [Speed Agree Detection Level] + <math>L4-02</math> [Speed Agree Detection Width]. After the terminal deactivates, the terminal stays off until the output frequency is at the level set with <math>L4-01</math>.</p> <p><b>Note:</b></p> <ul style="list-style-type: none"> <li>The detection function operates in the two motor rotation directions.</li> <li>In CLV, the motor speed is the reference.</li> </ul> <p>ON : The output frequency is less than the value of <math>L4-01</math> or is not more than the value of <math>L4-01 + L4-02</math>.</p> <p>OFF : The output frequency is higher than the value of <math>L4-01 + L4-02</math>.</p>	898
5	Frequency Detection 2	<p><b>V/f</b> <b>CL-V/f</b> <b>OLV</b> <b>CLV</b> <b>AOLV</b> <b>OLV/PM</b> <b>AOLV/PM</b> <b>CLV/PM</b> <b>EZOLV</b></p> <p>The terminal activates when the output frequency is higher than the setting value of <math>L4-01</math> [Speed Agree Detection Level]. After the terminal activates, the terminal stays on until the output frequency is at the value of <math>L4-01 - L4-02</math>.</p> <p>ON : The output frequency is higher than the value of <math>L4-01</math>.</p> <p>OFF : The output frequency is less than the value of "<math>L4-01 - L4-02</math>", or is less than the value of <math>L4-01</math>.</p>	899
6	Drive Ready	<p><b>V/f</b> <b>CL-V/f</b> <b>OLV</b> <b>CLV</b> <b>AOLV</b> <b>OLV/PM</b> <b>AOLV/PM</b> <b>CLV/PM</b> <b>EZOLV</b></p> <p>The terminal activates when the drive is ready and running.</p>	899
7	DC Bus Undervoltage	<p><b>V/f</b> <b>CL-V/f</b> <b>OLV</b> <b>CLV</b> <b>AOLV</b> <b>OLV/PM</b> <b>AOLV/PM</b> <b>CLV/PM</b> <b>EZOLV</b></p> <p>The terminal activates when the DC bus voltage or control circuit power supply is less than the voltage set with <math>L2-05</math> [Undervoltage Detect Level (Uv1)]. The terminal also turns on when there is a fault with the DC bus voltage.</p> <p>ON : The DC bus voltage is less than the setting value of <math>L2-05</math>.</p> <p>OFF : The DC bus voltage is more than the setting value of <math>L2-05</math>.</p>	899
8	During Baseblock (N.O.)	<p><b>V/f</b> <b>CL-V/f</b> <b>OLV</b> <b>CLV</b> <b>AOLV</b> <b>OLV/PM</b> <b>AOLV/PM</b> <b>CLV/PM</b> <b>EZOLV</b></p> <p>The terminal turns on during baseblock. When the drive is in baseblock, the drive output transistor stops switching and the drive will not make DC bus voltage.</p> <p>ON : During baseblock</p> <p>OFF : The drive is not in baseblock.</p>	899
9	Frequency Reference from Keypad	<p><b>V/f</b> <b>CL-V/f</b> <b>OLV</b> <b>CLV</b> <b>AOLV</b> <b>OLV/PM</b> <b>AOLV/PM</b> <b>CLV/PM</b> <b>EZOLV</b></p> <p>Shows the selected frequency reference source.</p> <p>ON : The keypad is the frequency reference source.</p> <p>OFF : <math>b1-01</math> or <math>b1-15</math> [Frequency Reference Selection 1 or 2] is the frequency reference source.</p>	900
A	Run Command from Keypad	<p><b>V/f</b> <b>CL-V/f</b> <b>OLV</b> <b>CLV</b> <b>AOLV</b> <b>OLV/PM</b> <b>AOLV/PM</b> <b>CLV/PM</b> <b>EZOLV</b></p> <p>Shows the selected Run command source.</p> <p>ON : The keypad is the Run command source.</p> <p>OFF : <math>b1-02</math> or <math>b1-16</math> [Run Command Selection 1 or 2] is the Run command source.</p>	900
B	Torque Detection 1 (N.O.)	<p><b>V/f</b> <b>CL-V/f</b> <b>OLV</b> <b>CLV</b> <b>AOLV</b> <b>OLV/PM</b> <b>AOLV/PM</b> <b>CLV/PM</b> <b>EZOLV</b></p> <p>The terminal activates when the drive detects overtorque or undertorque.</p> <p>ON : The output current/torque is more than the torque value set with <math>L6-02</math> [Torque Detection Level 1], or the level is less than the torque value set with <math>L6-02</math> for longer than the time set with <math>L6-03</math> [Torque Detection Time 1].</p>	900
C	Frequency Reference Loss	<p><b>V/f</b> <b>CL-V/f</b> <b>OLV</b> <b>CLV</b> <b>AOLV</b> <b>OLV/PM</b> <b>AOLV/PM</b> <b>CLV/PM</b> <b>EZOLV</b></p> <p>The terminal activates when the drive detects a loss of frequency reference.</p>	900
D	Braking Resistor Fault	<p><b>V/f</b> <b>CL-V/f</b> <b>OLV</b> <b>CLV</b> <b>AOLV</b> <b>OLV/PM</b> <b>AOLV/PM</b> <b>CLV/PM</b> <b>EZOLV</b></p> <p>The terminal activates when the mounting-type braking resistor is overheating or when there is a braking transistor fault.</p>	900

Setting	Function	Description	Ref.
E	Fault	<p><b>V/f</b> <b>CL-V/f</b> <b>OLV</b> <b>CLV</b> <b>AOLV</b> <b>OLV/PM</b> <b>AOLV/PM</b> <b>CLV/PM</b> <b>EZOLV</b></p> <p>The terminal activates when the drive detects a fault.</p> <p><b>Note:</b> The terminal will not turn on for <i>CPF00</i> and <i>CPF01</i> [Control Circuit Error] faults.</p>	900
F	Not Used	<p><b>V/f</b> <b>CL-V/f</b> <b>OLV</b> <b>CLV</b> <b>AOLV</b> <b>OLV/PM</b> <b>AOLV/PM</b> <b>CLV/PM</b> <b>EZOLV</b></p> <p>Use this setting for unused terminals or to use terminals in through mode. Also use this setting as the PLC contact output via MEMOBUS/Modbus or the communication option. This signal does not function if signals from the PLC are not configured.</p>	900
10	Alarm	<p><b>V/f</b> <b>CL-V/f</b> <b>OLV</b> <b>CLV</b> <b>AOLV</b> <b>OLV/PM</b> <b>AOLV/PM</b> <b>CLV/PM</b> <b>EZOLV</b></p> <p>The terminal turns on when the drive detects a minor fault.</p>	901
11	Fault Reset Command Active	<p><b>V/f</b> <b>CL-V/f</b> <b>OLV</b> <b>CLV</b> <b>AOLV</b> <b>OLV/PM</b> <b>AOLV/PM</b> <b>CLV/PM</b> <b>EZOLV</b></p> <p>The terminal turns on when the drive receives the Reset command from the control circuit terminal, serial communications, or the communication option.</p>	901
12	Timer Output	<p><b>V/f</b> <b>CL-V/f</b> <b>OLV</b> <b>CLV</b> <b>AOLV</b> <b>OLV/PM</b> <b>AOLV/PM</b> <b>CLV/PM</b> <b>EZOLV</b></p> <p>Use this setting when the drive uses the timer function as an output terminal.</p>	901
13	Speed Agree 2	<p><b>V/f</b> <b>CL-V/f</b> <b>OLV</b> <b>CLV</b> <b>AOLV</b> <b>OLV/PM</b> <b>AOLV/PM</b> <b>CLV/PM</b> <b>EZOLV</b></p> <p>The terminal activates when the output frequency is in the range of the frequency reference <math>\pm L4-04</math> [Speed Agree Detection Width (+/-)].</p> <p><b>Note:</b> The drive uses the motor speed as the reference in CLV and CLV/PM. ON : The output frequency is in the range of "frequency reference <math>\pm L4-04</math>". OFF : The output frequency is not in the range of "frequency reference <math>\pm L4-04</math>".</p>	901
14	User-Set Speed Agree 2	<p><b>V/f</b> <b>CL-V/f</b> <b>OLV</b> <b>CLV</b> <b>AOLV</b> <b>OLV/PM</b> <b>AOLV/PM</b> <b>CLV/PM</b> <b>EZOLV</b></p> <p>The terminal activates when the output frequency is in the range of <math>L4-03</math> [Speed Agree Detect Level (+/-)] <math>\pm L4-04</math> [Speed Agree Detect Width (+/-)] and in the range of the frequency reference <math>\pm L4-04</math>.</p> <p>ON : The output frequency is in the range of "<math>L4-03 \pm L4-04</math>" and the range of frequency reference <math>\pm L4-04</math>. OFF : The output frequency is not in the range of "<math>L4-03 \pm L4-04</math>" or the in the range of frequency reference <math>\pm L4-04</math>.</p>	901
15	Frequency Detection 3	<p><b>V/f</b> <b>CL-V/f</b> <b>OLV</b> <b>CLV</b> <b>AOLV</b> <b>OLV/PM</b> <b>AOLV/PM</b> <b>CLV/PM</b> <b>EZOLV</b></p> <p>The terminal deactivates when the output frequency is higher than the setting value of "<math>L4-03</math> [Speed Agree Detect Level (+/-)] + <math>L4-04</math> [Speed Agree Detect Width (+/-)]". After the terminal deactivates, the terminal stays off until the output frequency is at the value of <math>L4-03</math>.</p> <p><b>Note:</b> • The detection level set with <math>L4-03</math> is a signed value. The drive will only detect in one direction. • The drive uses the motor speed as the reference in CLV and CLV/PM. ON : The output frequency is less than the value of <math>L4-03</math> or is not higher than the value of <math>L4-03 + L4-04</math>. OFF : The output frequency is higher than the value of <math>L4-03 + L4-04</math>.</p>	902
16	Frequency Detection 4	<p><b>V/f</b> <b>CL-V/f</b> <b>OLV</b> <b>CLV</b> <b>AOLV</b> <b>OLV/PM</b> <b>AOLV/PM</b> <b>CLV/PM</b> <b>EZOLV</b></p> <p>The terminal activates when the output frequency is higher than the value of <math>L4-03</math> [Speed Agree Detect Level (+/-)]. After the terminal activates, the terminal stays on until the output frequency is at the value of <math>L4-03 - L4-04</math>.</p> <p>ON : The output frequency is higher than the value of <math>L4-03</math>. OFF : The output frequency is less than the value of "<math>L4-03 - L4-04</math>", or it is not higher than the value of <math>L4-03</math>.</p>	902
17	Torque Detection 1 (N.C.)	<p><b>V/f</b> <b>CL-V/f</b> <b>OLV</b> <b>CLV</b> <b>AOLV</b> <b>OLV/PM</b> <b>AOLV/PM</b> <b>CLV/PM</b> <b>EZOLV</b></p> <p>The terminal deactivates when the drive detects overtorque or undertorque.</p> <p>OFF : The output current/torque is more than the torque value set with <math>L6-02</math> [Torque Detection Level 1], or the level is less than the torque value set with <math>L6-02</math> for longer than the time set with <math>L6-03</math> [Torque Detection Time 1].</p>	903
18	Torque Detection 2 (N.O.)	<p><b>V/f</b> <b>CL-V/f</b> <b>OLV</b> <b>CLV</b> <b>AOLV</b> <b>OLV/PM</b> <b>AOLV/PM</b> <b>CLV/PM</b> <b>EZOLV</b></p> <p>The terminal activates when the drive detects overtorque or undertorque.</p> <p>ON : The output current/torque is more than the torque value set with <math>L6-05</math> [Torque Detection Level 2], or the level is less than the torque value set with <math>L6-05</math> for longer than the time set with <math>L6-06</math> [Torque Detection Time 2].</p>	903

## 10.10 H: Terminal Functions

Setting	Function	Description	Ref.
19	Torque Detection 2 (N.C.)	<p><b>V/f</b> <b>CL-V/f</b> <b>OLV</b> <b>CLV</b> <b>AOLV</b> <b>OLV/PM</b> <b>AOLV/PM</b> <b>CLV/PM</b> <b>EZOLV</b></p> <p>The terminal deactivates when the drive detects overtorque or undertorque.            OFF : The output current/torque is more than the torque value set with L6-05 [Torque Detection Level 2], or the level is less than the torque value set with L6-05 for longer than the time set with L6-06 [Torque Detection Time 2].</p>	903
1A	During Reverse	<p><b>V/f</b> <b>CL-V/f</b> <b>OLV</b> <b>CLV</b> <b>AOLV</b> <b>OLV/PM</b> <b>AOLV/PM</b> <b>CLV/PM</b> <b>EZOLV</b></p> <p>The terminal activates when the motor operates in the reverse direction.            ON : The motor is operating in the reverse direction.            OFF : The motor is operating in the forward direction or the motor stopped.</p>	904
1B	During Baseblock (N.C.)	<p><b>V/f</b> <b>CL-V/f</b> <b>OLV</b> <b>CLV</b> <b>AOLV</b> <b>OLV/PM</b> <b>AOLV/PM</b> <b>CLV/PM</b> <b>EZOLV</b></p> <p>The terminal deactivates during baseblock. When the drive is in baseblock, the drive output transistor stops switching and does not make DC bus voltage.            ON : The drive is not in baseblock.            OFF : During baseblock</p>	904
1C	Motor 2 Selected	<p><b>V/f</b> <b>CL-V/f</b> <b>OLV</b> <b>CLV</b> <b>AOLV</b> <b>OLV/PM</b> <b>AOLV/PM</b> <b>CLV/PM</b> <b>EZOLV</b></p> <p>The terminal activates when motor 2 is selected.            ON : Motor 2 Selection            OFF : Motor 1 Selection</p>	904
1D	During Regeneration	<p><b>V/f</b> <b>CL-V/f</b> <b>OLV</b> <b>CLV</b> <b>AOLV</b> <b>OLV/PM</b> <b>AOLV/PM</b> <b>CLV/PM</b> <b>EZOLV</b></p> <p>The terminal activates on when the motor is regenerating.            ON : Motor is regenerating.            OFF : Motor is operating or stopped.</p>	904
1E	Executing Auto-Restart	<p><b>V/f</b> <b>CL-V/f</b> <b>OLV</b> <b>CLV</b> <b>AOLV</b> <b>OLV/PM</b> <b>AOLV/PM</b> <b>CLV/PM</b> <b>EZOLV</b></p> <p>The terminal activates when the Auto Restart function is trying to restart after a fault.</p>	904
1F	Motor Overload Alarm (oL1)	<p><b>V/f</b> <b>CL-V/f</b> <b>OLV</b> <b>CLV</b> <b>AOLV</b> <b>OLV/PM</b> <b>AOLV/PM</b> <b>CLV/PM</b> <b>EZOLV</b></p> <p>The terminal activates when the electronic thermal protection value of the motor overload protective function is a minimum of 90% of the detection level.</p>	905
20	Drive Overheat Pre-Alarm (oH)	<p><b>V/f</b> <b>CL-V/f</b> <b>OLV</b> <b>CLV</b> <b>AOLV</b> <b>OLV/PM</b> <b>AOLV/PM</b> <b>CLV/PM</b> <b>EZOLV</b></p> <p>The terminal activates when the drive heatsink temperature is at the level set with L8-02 [Overheat Alarm Level].</p>	905
21	Safe Torque OFF	<p><b>V/f</b> <b>CL-V/f</b> <b>OLV</b> <b>CLV</b> <b>AOLV</b> <b>OLV/PM</b> <b>AOLV/PM</b> <b>CLV/PM</b> <b>EZOLV</b></p> <p>The terminal turns on (safety stop state) when the safety circuit and safety diagnosis circuit are operating correctly and when terminals H1-HC and H2-HC are off (released).            ON : Safety stop state            OFF : Safety circuit fault or RUN/READY</p>	905
22	Mechanical Weakening Detection	<p><b>V/f</b> <b>CL-V/f</b> <b>OLV</b> <b>CLV</b> <b>AOLV</b> <b>OLV/PM</b> <b>AOLV/PM</b> <b>CLV/PM</b> <b>EZOLV</b></p> <p>The terminal activates when the drive detects mechanical weakening.</p>	905
2F	Maintenance Notification	<p><b>V/f</b> <b>CL-V/f</b> <b>OLV</b> <b>CLV</b> <b>AOLV</b> <b>OLV/PM</b> <b>AOLV/PM</b> <b>CLV/PM</b> <b>EZOLV</b></p> <p>The terminal activates when drive components are at their estimated maintenance period. Tells the user about the maintenance period for these items:</p> <ul style="list-style-type: none"> <li>• IGBT</li> <li>• Cooling fan</li> <li>• Capacitor</li> <li>• Soft charge bypass relay</li> </ul>	905
30	During Torque Limit	<p><b>V/f</b> <b>CL-V/f</b> <b>OLV</b> <b>CLV</b> <b>AOLV</b> <b>OLV/PM</b> <b>AOLV/PM</b> <b>CLV/PM</b> <b>EZOLV</b></p> <p>The terminal activates when the torque reference is the torque limit set with L7 parameters, H3-02, H3-06, or H3-10 [MFAI Function Select].</p>	906
31	During Speed Limit	<p><b>V/f</b> <b>CL-V/f</b> <b>OLV</b> <b>CLV</b> <b>AOLV</b> <b>OLV/PM</b> <b>AOLV/PM</b> <b>CLV/PM</b> <b>EZOLV</b></p> <p>The terminal activates when the speed limit is active.</p>	906
32	In Speed Limit During Trq Ctrl	<p><b>V/f</b> <b>CL-V/f</b> <b>OLV</b> <b>CLV</b> <b>AOLV</b> <b>OLV/PM</b> <b>AOLV/PM</b> <b>CLV/PM</b> <b>EZOLV</b></p> <p>The motor accelerates in the forward direction or the reverse direction after enabling torque control and the externally input torque reference is disproportionate to the load. The output terminal activates when this speed is not higher than a constant speed and the motor speed is at the speed limit. This does not include operation when the drive is stopped.</p>	906
33	Zero Servo Complete	<p><b>V/f</b> <b>CL-V/f</b> <b>OLV</b> <b>CLV</b> <b>AOLV</b> <b>OLV/PM</b> <b>AOLV/PM</b> <b>CLV/PM</b> <b>EZOLV</b></p> <p>The terminal activates when positioning in the range set with b9-02 [Zero Servo Completion Window] completes after sending the Zero-Servo command.</p>	906

Setting	Function	Description	Ref.
37	During Frequency Output	<b>V/f</b> <b>CL-V/f</b> <b>OLV</b> <b>CLV</b> <b>AOLV</b> <b>OLV/PM</b> <b>AOLV/PM</b> <b>CLV/PM</b> <b>EZOLV</b> The terminal activates when the drive outputs frequency. ON : The drive outputs frequency. OFF : The drive does not output frequency.	906
38	Drive Enabled	<b>V/f</b> <b>CL-V/f</b> <b>OLV</b> <b>CLV</b> <b>AOLV</b> <b>OLV/PM</b> <b>AOLV/PM</b> <b>CLV/PM</b> <b>EZOLV</b> This terminal activates when the $H1-xx = 6A$ [Drive Enable] terminal activates.	907
39	Watt Hour Pulse Output	<b>V/f</b> <b>CL-V/f</b> <b>OLV</b> <b>CLV</b> <b>AOLV</b> <b>OLV/PM</b> <b>AOLV/PM</b> <b>CLV/PM</b> <b>EZOLV</b> Outputs the pulse that shows the watt hours.	907
3C	LOCAL Control Selected	<b>V/f</b> <b>CL-V/f</b> <b>OLV</b> <b>CLV</b> <b>AOLV</b> <b>OLV/PM</b> <b>AOLV/PM</b> <b>CLV/PM</b> <b>EZOLV</b> The terminal activates when the Run command source or frequency reference source is LOCAL. ON : LOCAL OFF : REMOTE	907
3D	During Speed Search	<b>V/f</b> <b>CL-V/f</b> <b>OLV</b> <b>CLV</b> <b>AOLV</b> <b>OLV/PM</b> <b>AOLV/PM</b> <b>CLV/PM</b> <b>EZOLV</b> The terminal activates when the drive is doing speed search.	907
3E	PID Feedback Low	<b>V/f</b> <b>CL-V/f</b> <b>OLV</b> <b>CLV</b> <b>AOLV</b> <b>OLV/PM</b> <b>AOLV/PM</b> <b>CLV/PM</b> <b>EZOLV</b> The activates when the drive detects $FbL$ [PID Feedback Loss].	907
3F	PID Feedback High	<b>V/f</b> <b>CL-V/f</b> <b>OLV</b> <b>CLV</b> <b>AOLV</b> <b>OLV/PM</b> <b>AOLV/PM</b> <b>CLV/PM</b> <b>EZOLV</b> The terminal activates when the drive detects $FbH$ [Excessive PID Feedback].	908
4A	During KEB Ride-Thru	<b>V/f</b> <b>CL-V/f</b> <b>OLV</b> <b>CLV</b> <b>AOLV</b> <b>OLV/PM</b> <b>AOLV/PM</b> <b>CLV/PM</b> <b>EZOLV</b> The activates during KEB Ride-Thru.	908
4B	During Short Circuit Braking	<b>V/f</b> <b>CL-V/f</b> <b>OLV</b> <b>CLV</b> <b>AOLV</b> <b>OLV/PM</b> <b>AOLV/PM</b> <b>CLV/PM</b> <b>EZOLV</b> The terminal activates during Short Circuit Braking. <b>Note:</b> When $A1-02 = 8$ [Control Method Selection = EZ Vector Control], this function is available if you use a PM motor.	908
4C	During Fast Stop	<b>V/f</b> <b>CL-V/f</b> <b>OLV</b> <b>CLV</b> <b>AOLV</b> <b>OLV/PM</b> <b>AOLV/PM</b> <b>CLV/PM</b> <b>EZOLV</b> The terminal activates when the fast stop is in operation.	908
4D	oH Pre-Alarm Reduction Limit	<b>V/f</b> <b>CL-V/f</b> <b>OLV</b> <b>CLV</b> <b>AOLV</b> <b>OLV/PM</b> <b>AOLV/PM</b> <b>CLV/PM</b> <b>EZOLV</b> The terminal activates when $L8-03 = 4$ [Overheat Pre-Alarm Selection = Operate at Reduced Speed (L8-19)] and $oH$ [Heatsink Overheat] does not clear after the drive decreases the frequency for 10 cycles.	908
4E	Braking Transistor Fault (rr)	<b>V/f</b> <b>CL-V/f</b> <b>OLV</b> <b>CLV</b> <b>AOLV</b> <b>OLV/PM</b> <b>AOLV/PM</b> <b>CLV/PM</b> <b>EZOLV</b> The terminal activates when the internal braking transistor overheats and the drive detects an $rr$ [Dynamic Braking Transistor Fault] fault.	908
4F	Braking Resistor Overheat (rH)	<b>V/f</b> <b>CL-V/f</b> <b>OLV</b> <b>CLV</b> <b>AOLV</b> <b>OLV/PM</b> <b>AOLV/PM</b> <b>CLV/PM</b> <b>EZOLV</b> The terminal activates when the braking resistor overheats and the drive detects an $rH$ [Braking Resistor Overheat] fault.	908
60	Internal Cooling Fan Failure	<b>V/f</b> <b>CL-V/f</b> <b>OLV</b> <b>CLV</b> <b>AOLV</b> <b>OLV/PM</b> <b>AOLV/PM</b> <b>CLV/PM</b> <b>EZOLV</b> The terminal activates when the drive detects a cooling fan failure in the drive.	909
61	Pole Position Detection Complete	<b>V/f</b> <b>CL-V/f</b> <b>OLV</b> <b>CLV</b> <b>AOLV</b> <b>OLV/PM</b> <b>AOLV/PM</b> <b>CLV/PM</b> <b>EZOLV</b> The terminal activates when drive receives a Run command and the drive detects the motor magnetic pole position of the PM motor.	909
62	Modbus Reg 1 Status Satisfied	<b>V/f</b> <b>CL-V/f</b> <b>OLV</b> <b>CLV</b> <b>AOLV</b> <b>OLV/PM</b> <b>AOLV/PM</b> <b>CLV/PM</b> <b>EZOLV</b> The terminal activates when the bit specified by $H2-08$ [Modbus Register 1 Bit Select] for the MEMOBUS register address set with $H2-07$ [Modbus Register 1 Address Select] activates.	909
63	Modbus Reg 2 Status Satisfied	<b>V/f</b> <b>CL-V/f</b> <b>OLV</b> <b>CLV</b> <b>AOLV</b> <b>OLV/PM</b> <b>AOLV/PM</b> <b>CLV/PM</b> <b>EZOLV</b> The terminal activates when the bit specified by $H2-10$ [Modbus Register 2 Bit Select] for the MEMOBUS register address set with $H2-09$ [Modbus Register 2 Address Select] activates.	909
65	Standby Output	<b>V/f</b> <b>CL-V/f</b> <b>OLV</b> <b>CLV</b> <b>AOLV</b> <b>OLV/PM</b> <b>AOLV/PM</b> <b>CLV/PM</b> <b>EZOLV</b> The terminal deactivates after the drive stops operating and after the time set with $b8-51$ [Standby Mode Wait Time]. ON : The Run command turns on and the magnetic contactor on the input side turns on. OFF : The Run command turns off and the drive stops operating. Then, the magnetic contactor on the input side turns off after the time set with $b8-51$ [Standby Mode Wait Time].	909

## 10.10 H: Terminal Functions

Setting	Function	Description	Ref.
66	Comparator1	<b>V/f</b> <b>CL-V/f</b> <b>OLV</b> <b>CLV</b> <b>AOLV</b> <b>OLV/PM</b> <b>AOLV/PM</b> <b>CLV/PM</b> <b>EZOLV</b> The monitor value set with H2-20 [Comparator 1 Monitor Selection] is on while in range of the time set with H2-24 [Comparator 1 On-Delay Time] and the values of H2-21 [Comparator 1 Lower Limit] and H2-22 [Comparator 1 Upper Limit] are in range.	909
67	Comparator2	<b>V/f</b> <b>CL-V/f</b> <b>OLV</b> <b>CLV</b> <b>AOLV</b> <b>OLV/PM</b> <b>AOLV/PM</b> <b>CLV/PM</b> <b>EZOLV</b> The monitor value set with H2-26 [Comparator 2 Monitor Selection] is on while in range of the time set with H2-30 [Comparator 2 On-Delay Time] and the values of H2-27 [Comparator 2 Lower Limit] and H2-28 [Comparator 2 Upper Limit] are in range.	910
69	External Power 24V Supply	<b>V/f</b> <b>CL-V/f</b> <b>OLV</b> <b>CLV</b> <b>AOLV</b> <b>OLV/PM</b> <b>AOLV/PM</b> <b>CLV/PM</b> <b>EZOLV</b> The terminal activates when there is an external 24V power supply between terminals PS-AC. ON : An external 24V power supply supplies power. OFF : An external 24V power supply does not supply power.	910
6A	Data Logger Error	<b>V/f</b> <b>CL-V/f</b> <b>OLV</b> <b>CLV</b> <b>AOLV</b> <b>OLV/PM</b> <b>AOLV/PM</b> <b>CLV/PM</b> <b>EZOLV</b> The terminal activates when the drive detects a LoG [Com Error / Abnormal SD card].	910
90 to 93	DWEZ Digital Outputs 1 to 4	<b>V/f</b> <b>CL-V/f</b> <b>OLV</b> <b>CLV</b> <b>AOLV</b> <b>OLV/PM</b> <b>AOLV/PM</b> <b>CLV/PM</b> <b>EZOLV</b> Sets the DriveWorksEZ digital output. Refer to the DriveWorksEZ online manual for more information.	911
A0 to A7	DWEZ Extended Digital Output 1 to 8	<b>V/f</b> <b>CL-V/f</b> <b>OLV</b> <b>CLV</b> <b>AOLV</b> <b>OLV/PM</b> <b>AOLV/PM</b> <b>CLV/PM</b> <b>EZOLV</b> Sets the digital output for the DriveWorksEZ DO-A3 option card. Refer to the DriveWorksEZ online manual for more information.	911
100 to 1A7	Inverse Output of 0 to A7	<b>V/f</b> <b>CL-V/f</b> <b>OLV</b> <b>CLV</b> <b>AOLV</b> <b>OLV/PM</b> <b>AOLV/PM</b> <b>CLV/PM</b> <b>EZOLV</b> Causes inverse output of the function for the selected MFDO. Uses the last two digits of 1xx to select which function to inversely output.	911

## ◆ H3: Analog Inputs

No. (Hex.)	Name	Description	Default (Range)	Ref.
H3-01 (0410)	Terminal A1 Signal Level Select	<b>V/f</b> <b>CL-V/f</b> <b>OLV</b> <b>CLV</b> <b>AOLV</b> <b>OLV/PM</b> <b>AOLV/PM</b> <b>CLV/PM</b> <b>EZOLV</b> Sets the input signal level for MFAI terminal A1. 0 : 0 to 10V (Lower Limit at 0) 1 : -10 to +10V (Bipolar Reference) 2 : 4 to 20 mA 3 : 0 to 20 mA	0 (0 - 3)	913
H3-02 (0434)	Terminal A1 Function Selection	<b>V/f</b> <b>CL-V/f</b> <b>OLV</b> <b>CLV</b> <b>AOLV</b> <b>OLV/PM</b> <b>AOLV/PM</b> <b>CLV/PM</b> <b>EZOLV</b> Sets a function for MFAI terminal A1.	0 (0 - 32)	913
H3-03 (0411) RUN	Terminal A1 Gain Setting	<b>V/f</b> <b>CL-V/f</b> <b>OLV</b> <b>CLV</b> <b>AOLV</b> <b>OLV/PM</b> <b>AOLV/PM</b> <b>CLV/PM</b> <b>EZOLV</b> Sets the gain of the analog signal input to MFAI terminal A1.	100.0% (-999.9 - +999.9%)	913
H3-04 (0412) RUN	Terminal A1 Bias Setting	<b>V/f</b> <b>CL-V/f</b> <b>OLV</b> <b>CLV</b> <b>AOLV</b> <b>OLV/PM</b> <b>AOLV/PM</b> <b>CLV/PM</b> <b>EZOLV</b> Sets the bias of the analog signal input to MFAI terminal A1.	0.0% (-999.9 - +999.9%)	914
H3-05 (0413)	Terminal A3 Signal Level Select	<b>V/f</b> <b>CL-V/f</b> <b>OLV</b> <b>CLV</b> <b>AOLV</b> <b>OLV/PM</b> <b>AOLV/PM</b> <b>CLV/PM</b> <b>EZOLV</b> Sets the input signal level for MFAI terminal A3. 0 : 0-10V (LowLim=0) 1 : -10 to +10V (Bipolar Reference) 2 : 4 to 20 mA 3 : 0 to 20 mA	0 (0 - 3)	914
H3-06 (0414)	Terminal A3 Function Selection	<b>V/f</b> <b>CL-V/f</b> <b>OLV</b> <b>CLV</b> <b>AOLV</b> <b>OLV/PM</b> <b>AOLV/PM</b> <b>CLV/PM</b> <b>EZOLV</b> Sets a function for MFAI terminal A3.	2 (0 - 32)	914
H3-07 (0415) RUN	Terminal A3 Gain Setting	<b>V/f</b> <b>CL-V/f</b> <b>OLV</b> <b>CLV</b> <b>AOLV</b> <b>OLV/PM</b> <b>AOLV/PM</b> <b>CLV/PM</b> <b>EZOLV</b> Sets the gain of the analog signal input to MFAI terminal A3.	100.0% (-999.9 - +999.9%)	915
H3-08 (0416) RUN	Terminal A3 Bias Setting	<b>V/f</b> <b>CL-V/f</b> <b>OLV</b> <b>CLV</b> <b>AOLV</b> <b>OLV/PM</b> <b>AOLV/PM</b> <b>CLV/PM</b> <b>EZOLV</b> Sets the bias of the analog signal input to MFAI terminal A3.	0.0% (-999.9 - +999.9%)	915



No. (Hex.)	Name	Description	Default (Range)	Ref.
H3-09 (0417)	Terminal A2 Signal Level Select	<b>V/f</b> <b>CL-V/f</b> <b>OLV</b> <b>CLV</b> <b>AOLV</b> <b>OLV/PM</b> <b>AOLV/PM</b> <b>CLV/PM</b> <b>EZOLV</b> Sets the input signal level for MFAI terminal A2. 0 : 0-10V (LowLim=0) 1 : -10 to +10V (Bipolar Reference) 2 : 4 to 20 mA 3 : 0 to 20 mA	2 (0 - 3)	915
H3-10 (0418)	Terminal A2 Function Selection	<b>V/f</b> <b>CL-V/f</b> <b>OLV</b> <b>CLV</b> <b>AOLV</b> <b>OLV/PM</b> <b>AOLV/PM</b> <b>CLV/PM</b> <b>EZOLV</b> Sets a function for MFAI terminal A2.	0 (0 - 32)	915
H3-11 (0419) RUN	Terminal A2 Gain Setting	<b>V/f</b> <b>CL-V/f</b> <b>OLV</b> <b>CLV</b> <b>AOLV</b> <b>OLV/PM</b> <b>AOLV/PM</b> <b>CLV/PM</b> <b>EZOLV</b> Sets the gain of the analog signal input to MFAI terminal A2.	100.0% (-999.9 - +999.9%)	916
H3-12 (041A) RUN	Terminal A2 Bias Setting	<b>V/f</b> <b>CL-V/f</b> <b>OLV</b> <b>CLV</b> <b>AOLV</b> <b>OLV/PM</b> <b>AOLV/PM</b> <b>CLV/PM</b> <b>EZOLV</b> Sets the bias of the analog signal input to MFAI terminal A2.	0.0% (-999.9 - +999.9%)	916
H3-13 (041B)	Analog Input FilterTime Constant	<b>V/f</b> <b>CL-V/f</b> <b>OLV</b> <b>CLV</b> <b>AOLV</b> <b>OLV/PM</b> <b>AOLV/PM</b> <b>CLV/PM</b> <b>EZOLV</b> Sets the time constant to apply a primary delay filter to the MFAI terminal.	0.03 s (0.00 - 2.00 s)	916
H3-14 (041C)	Analog Input Terminal Enable Sel	<b>V/f</b> <b>CL-V/f</b> <b>OLV</b> <b>CLV</b> <b>AOLV</b> <b>OLV/PM</b> <b>AOLV/PM</b> <b>CLV/PM</b> <b>EZOLV</b> Sets the enabled terminal or terminals when $HI-xx = C$ [ <i>MFDI Function Select = Analog Terminal Enable Selection</i> ] is ON. 1 : Terminal A1 only 2 : Terminal A2 only 3 : Terminals A1 and A2 4 : Terminal A3 only 5 : Terminals A1 and A3 6 : Terminals A2 and A3 7 : Terminals A1, A2, and A3	7 (1 - 7)	916
H3-16 (02F0)	Terminal A1 Offset	<b>V/f</b> <b>CL-V/f</b> <b>OLV</b> <b>CLV</b> <b>AOLV</b> <b>OLV/PM</b> <b>AOLV/PM</b> <b>CLV/PM</b> <b>EZOLV</b> Sets the offset level for analog signals input to terminal A1. Usually it is not necessary to change this setting.	0 (-500 - +500)	917
H3-17 (02F1)	Terminal A2 Offset	<b>V/f</b> <b>CL-V/f</b> <b>OLV</b> <b>CLV</b> <b>AOLV</b> <b>OLV/PM</b> <b>AOLV/PM</b> <b>CLV/PM</b> <b>EZOLV</b> Sets the offset level for analog signals input to terminal A2. Usually it is not necessary to change this setting.	0 (-500 - +500)	917
H3-18 (02F2)	Terminal A3 Offset	<b>V/f</b> <b>CL-V/f</b> <b>OLV</b> <b>CLV</b> <b>AOLV</b> <b>OLV/PM</b> <b>AOLV/PM</b> <b>CLV/PM</b> <b>EZOLV</b> Sets the offset level for analog signals input to terminal A3. Usually it is not necessary to change this setting.	0 (-500 - +500)	917
H3-40 (0B5C)	Mbus Reg 15C1h Input Function	<b>V/f</b> <b>CL-V/f</b> <b>OLV</b> <b>CLV</b> <b>AOLV</b> <b>OLV/PM</b> <b>AOLV/PM</b> <b>CLV/PM</b> <b>EZOLV</b> Sets the MEMOBUS AI1 function.	F (4 - 2F)	917
H3-41 (0B5F)	Mbus Reg 15C2h Input Function	<b>V/f</b> <b>CL-V/f</b> <b>OLV</b> <b>CLV</b> <b>AOLV</b> <b>OLV/PM</b> <b>AOLV/PM</b> <b>CLV/PM</b> <b>EZOLV</b> Sets the MEMOBUS AI2 function.	F (4 - 2F)	917
H3-42 (0B62)	Mbus Reg 15C3h Input Function	<b>V/f</b> <b>CL-V/f</b> <b>OLV</b> <b>CLV</b> <b>AOLV</b> <b>OLV/PM</b> <b>AOLV/PM</b> <b>CLV/PM</b> <b>EZOLV</b> Sets the MEMOBUS AI3 function.	F (4 - 2F)	917
H3-43 (117F)	Mbus Reg Inputs FilterTime Const	<b>V/f</b> <b>CL-V/f</b> <b>OLV</b> <b>CLV</b> <b>AOLV</b> <b>OLV/PM</b> <b>AOLV/PM</b> <b>CLV/PM</b> <b>EZOLV</b> Sets the time constant to apply a primary delay filter to the MEMOBUS analog input terminal.	0.00 s (0.00 - 2.00 s)	918

### ■ H3-xx: MFAI Function Selections

Setting	Function	Description	Ref.
0	Frequency Reference	<b>V/f</b> <b>CL-V/f</b> <b>OLV</b> <b>CLV</b> <b>AOLV</b> <b>OLV/PM</b> <b>AOLV/PM</b> <b>CLV/PM</b> <b>EZOLV</b> The input value from the MFAI terminal set with this function becomes the master frequency reference.	918
1	Frequency Gain	<b>V/f</b> <b>CL-V/f</b> <b>OLV</b> <b>CLV</b> <b>AOLV</b> <b>OLV/PM</b> <b>AOLV/PM</b> <b>CLV/PM</b> <b>EZOLV</b> The drive multiplies the analog frequency reference with the input value from the MFAI set with this function.	918

## 10.10 H: Terminal Functions

Setting	Function	Description	Ref.
2	Auxiliary Frequency Reference 1	<b>V/f</b> <b>CL-V/f</b> <b>OLV</b> <b>CLV</b> <b>AOLV</b> <b>OLV/PM</b> <b>AOLV/PM</b> <b>CLV/PM</b> <b>EZOLV</b> Sets Reference 2 through multi-step speed reference to enable the command reference (Auxiliary Frequency Reference 1) from the analog input terminal set here. This value is a percentage where <i>E1-04 [Maximum Output Frequency]</i> setting is a setting value of 100%.	918
3	Auxiliary Frequency Reference 2	<b>V/f</b> <b>CL-V/f</b> <b>OLV</b> <b>CLV</b> <b>AOLV</b> <b>OLV/PM</b> <b>AOLV/PM</b> <b>CLV/PM</b> <b>EZOLV</b> Sets Reference 3 through multi-step speed reference to enable the command reference (Auxiliary Frequency Reference 2) from the analog input terminal set here. This value is a percentage where <i>E1-04 [Maximum Output Frequency]</i> setting is a setting value of 100%.	918
4	Output Voltage Bias	<b>V/f</b> <b>CL-V/f</b> <b>OLV</b> <b>CLV</b> <b>AOLV</b> <b>OLV/PM</b> <b>AOLV/PM</b> <b>CLV/PM</b> <b>EZOLV</b> Set this parameter to input a bias signal and amplify the output voltage.	918
5	Accel/Decel Time Gain	<b>V/f</b> <b>CL-V/f</b> <b>OLV</b> <b>CLV</b> <b>AOLV</b> <b>OLV/PM</b> <b>AOLV/PM</b> <b>CLV/PM</b> <b>EZOLV</b> Enters a signal to adjust the gain used for C1-01 to C1-08 [ <i>Accel &amp; Decel Time 1 through 4</i> ] if the full scale analog signal (10 V or 20 mA) is 100%.	919
6	DC Injection Braking Current	<b>V/f</b> <b>CL-V/f</b> <b>OLV</b> <b>CLV</b> <b>AOLV</b> <b>OLV/PM</b> <b>AOLV/PM</b> <b>CLV/PM</b> <b>EZOLV</b> Enters a signal to adjust the current level used for DC Injection Braking if the drive rated output current is 100%.	919
7	Torque Detection Level	<b>V/f</b> <b>CL-V/f</b> <b>OLV</b> <b>CLV</b> <b>AOLV</b> <b>OLV/PM</b> <b>AOLV/PM</b> <b>CLV/PM</b> <b>EZOLV</b> Enters a signal to adjust the overtorque/undertorque detection level. <b>Note:</b> Use this function with L6-01 [ <i>Torque Detection Selection 1</i> ]. This parameter functions as an alternative to L6-02 [ <i>Torque Detection Level 1</i> ].	920
8	Stall Prevent Level During Run	<b>V/f</b> <b>CL-V/f</b> <b>OLV</b> <b>CLV</b> <b>AOLV</b> <b>OLV/PM</b> <b>AOLV/PM</b> <b>CLV/PM</b> <b>EZOLV</b> Enters a signal to adjust the stall prevention level during run if the drive rated current is 100%.	920
9	Output Frequency Lower Limit	<b>V/f</b> <b>CL-V/f</b> <b>OLV</b> <b>CLV</b> <b>AOLV</b> <b>OLV/PM</b> <b>AOLV/PM</b> <b>CLV/PM</b> <b>EZOLV</b> Enters a signal to adjust the output frequency lower limit level if <i>E1-04 [Maximum Output Frequency]</i> = 100%.	920
B	PID Feedback	<b>V/f</b> <b>CL-V/f</b> <b>OLV</b> <b>CLV</b> <b>AOLV</b> <b>OLV/PM</b> <b>AOLV/PM</b> <b>CLV/PM</b> <b>EZOLV</b> Enters the PID feedback value.	920
C	PID Setpoint	<b>V/f</b> <b>CL-V/f</b> <b>OLV</b> <b>CLV</b> <b>AOLV</b> <b>OLV/PM</b> <b>AOLV/PM</b> <b>CLV/PM</b> <b>EZOLV</b> Enters the PID setpoint.	920
D	Frequency Bias	<b>V/f</b> <b>CL-V/f</b> <b>OLV</b> <b>CLV</b> <b>AOLV</b> <b>OLV/PM</b> <b>AOLV/PM</b> <b>CLV/PM</b> <b>EZOLV</b> Enters the bias value added to the frequency reference if <i>E1-04 [Maximum Output Frequency]</i> is 100%.	921
E	Motor Temperature (PTC Input)	<b>V/f</b> <b>CL-V/f</b> <b>OLV</b> <b>CLV</b> <b>AOLV</b> <b>OLV/PM</b> <b>AOLV/PM</b> <b>CLV/PM</b> <b>EZOLV</b> Uses the motor Positive Temperature Coefficient (PTC) thermistor to prevent heat damage to the motor if the current value when the 10 V (or 20 mA) analog signal is input is 100%.	921
F	Not Used	<b>V/f</b> <b>CL-V/f</b> <b>OLV</b> <b>CLV</b> <b>AOLV</b> <b>OLV/PM</b> <b>AOLV/PM</b> <b>CLV/PM</b> <b>EZOLV</b> Value for terminals that are not being used or terminals being used in through mode.	921
10	Forward Torque Limit	<b>V/f</b> <b>CL-V/f</b> <b>OLV</b> <b>CLV</b> <b>AOLV</b> <b>OLV/PM</b> <b>AOLV/PM</b> <b>CLV/PM</b> <b>EZOLV</b> Enters the forward torque limit if the motor rated torque is 100%.	921
11	Reverse Torque Limit	<b>V/f</b> <b>CL-V/f</b> <b>OLV</b> <b>CLV</b> <b>AOLV</b> <b>OLV/PM</b> <b>AOLV/PM</b> <b>CLV/PM</b> <b>EZOLV</b> Enters the load torque limit if the motor rated torque is 100%.	922
12	Regenerative Torque Limit	<b>V/f</b> <b>CL-V/f</b> <b>OLV</b> <b>CLV</b> <b>AOLV</b> <b>OLV/PM</b> <b>AOLV/PM</b> <b>CLV/PM</b> <b>EZOLV</b> Enters the regenerative torque limit if the motor rated torque is 100%.	922
13	Torque Reference / Torque Limit	<b>V/f</b> <b>CL-V/f</b> <b>OLV</b> <b>CLV</b> <b>AOLV</b> <b>OLV/PM</b> <b>AOLV/PM</b> <b>CLV/PM</b> <b>EZOLV</b> Enters the torque reference if the motor rated torque is 100%. This setting is the torque limit for speed control.	923
14	Torque Compensation	<b>V/f</b> <b>CL-V/f</b> <b>OLV</b> <b>CLV</b> <b>AOLV</b> <b>OLV/PM</b> <b>AOLV/PM</b> <b>CLV/PM</b> <b>EZOLV</b> Enters the torque compensation value if the motor rated torque is 100%.	923
15	General Torque Limit	<b>V/f</b> <b>CL-V/f</b> <b>OLV</b> <b>CLV</b> <b>AOLV</b> <b>OLV/PM</b> <b>AOLV/PM</b> <b>CLV/PM</b> <b>EZOLV</b> Enters the torque limit that is the same for all quadrants for forward, reverse, and regenerative operation if the motor rated torque is 100%.	923
16	Differential PID Feedback	<b>V/f</b> <b>CL-V/f</b> <b>OLV</b> <b>CLV</b> <b>AOLV</b> <b>OLV/PM</b> <b>AOLV/PM</b> <b>CLV/PM</b> <b>EZOLV</b> Enters the PID differential feedback value if the full scale analog signal (10 V or 20 mA) is 100%.	923

Setting	Function	Description	Ref.
1F	Not Used	<b>V/f</b> <b>CL-V/f</b> <b>OLV</b> <b>CLV</b> <b>AOLV</b> <b>OLV/PM</b> <b>AOLV/PM</b> <b>CLV/PM</b> <b>EZOLV</b> Value for terminals that are not being used or terminals being used in through mode.	923
30	DWEZ Analog Input 1	<b>V/f</b> <b>CL-V/f</b> <b>OLV</b> <b>CLV</b> <b>AOLV</b> <b>OLV/PM</b> <b>AOLV/PM</b> <b>CLV/PM</b> <b>EZOLV</b> Use with DriveWorksEZ. Refer to the DriveWorksEZ online manual for more information.	923
31	DWEZ Analog Input 2	<b>V/f</b> <b>CL-V/f</b> <b>OLV</b> <b>CLV</b> <b>AOLV</b> <b>OLV/PM</b> <b>AOLV/PM</b> <b>CLV/PM</b> <b>EZOLV</b> Use with DriveWorksEZ. Refer to the DriveWorksEZ online manual for more information.	923
32	DWEZ Analog Input 3	<b>V/f</b> <b>CL-V/f</b> <b>OLV</b> <b>CLV</b> <b>AOLV</b> <b>OLV/PM</b> <b>AOLV/PM</b> <b>CLV/PM</b> <b>EZOLV</b> Use with DriveWorksEZ. Refer to the DriveWorksEZ online manual for more information.	923

#### ◆ H4: Analog Outputs

No. (Hex.)	Name	Description	Default (Range)	Ref.
H4-01 (041D)	Terminal FM Analog Output Select	<b>V/f</b> <b>CL-V/f</b> <b>OLV</b> <b>CLV</b> <b>AOLV</b> <b>OLV/PM</b> <b>AOLV/PM</b> <b>CLV/PM</b> <b>EZOLV</b> Sets the monitor number to send from MFAO terminal FM. Set the <i>x-xx</i> part of the <i>Ux-xx</i> [Monitor]. For example, set <i>H4-01 = 102</i> to monitor <i>U1-02</i> [Output Frequency].	102 (000 - 999)	925
H4-02 (041E) RUN	Terminal FM Analog Output Gain	<b>V/f</b> <b>CL-V/f</b> <b>OLV</b> <b>CLV</b> <b>AOLV</b> <b>OLV/PM</b> <b>AOLV/PM</b> <b>CLV/PM</b> <b>EZOLV</b> Sets the gain of the monitor signal that is sent from MFAO terminal FM. Sets the analog signal output level from the terminal FM at 10 V or 20 mA as 100% when an output for monitoring items is 100%.	100.0% (-999.9 - +999.9%)	925
H4-03 (041F) RUN	Terminal FM Analog Output Bias	<b>V/f</b> <b>CL-V/f</b> <b>OLV</b> <b>CLV</b> <b>AOLV</b> <b>OLV/PM</b> <b>AOLV/PM</b> <b>CLV/PM</b> <b>EZOLV</b> Sets the bias of the monitor signal that is sent from MFAO terminal FM. Set the level of the analog signal sent from terminal FM at 10 V or 20 mA as 100% when an output for monitoring items is 0%.	0.0% (-999.9 - +999.9%)	925
H4-04 (0420)	Terminal AM Analog Output Select	<b>V/f</b> <b>CL-V/f</b> <b>OLV</b> <b>CLV</b> <b>AOLV</b> <b>OLV/PM</b> <b>AOLV/PM</b> <b>CLV/PM</b> <b>EZOLV</b> Sets the monitoring number to be output from the MFAO terminal AM. Set the <i>x-xx</i> part of the <i>Ux-xx</i> [Monitor]. For example, set <i>H4-04</i> to <i>102</i> to monitor <i>U1-02</i> [Output Frequency].	103 (000 - 999)	925
H4-05 (0421) RUN	Terminal AM Analog Output Gain	<b>V/f</b> <b>CL-V/f</b> <b>OLV</b> <b>CLV</b> <b>AOLV</b> <b>OLV/PM</b> <b>AOLV/PM</b> <b>CLV/PM</b> <b>EZOLV</b> Sets the gain of the monitor signal that is sent from MFAO terminal AM. When an output for monitoring items is 0%, this parameter sets the analog signal output level from the AM terminal at 10 V or 20 mA as 100%.	50.0% (-999.9 - +999.9%)	926
H4-06 (0422) RUN	Terminal AM Analog Output Bias	<b>V/f</b> <b>CL-V/f</b> <b>OLV</b> <b>CLV</b> <b>AOLV</b> <b>OLV/PM</b> <b>AOLV/PM</b> <b>CLV/PM</b> <b>EZOLV</b> Sets the bias of the monitor signal that is sent from MFAO terminal AM. Set the level of the analog signal sent from the AM terminal at 10 V or 20 mA as 100% when an output for monitoring items is 0%.	0.0% (-999.9 - +999.9%)	926
H4-07 (0423)	Terminal FM Signal Level Select	<b>V/f</b> <b>CL-V/f</b> <b>OLV</b> <b>CLV</b> <b>AOLV</b> <b>OLV/PM</b> <b>AOLV/PM</b> <b>CLV/PM</b> <b>EZOLV</b> Sets the MFAO terminal FM output signal level. <b>Note:</b> Set jumper S5 on the terminal board to the correct position after changing this parameter. 0 : 0 to 10 Vdc 1 : -10 to +10 Vdc 2 : 4 to 20 mA	0 (0 - 2)	926

No. (Hex.)	Name	Description	Default (Range)	Ref.
H4-08 (0424)	Terminal AM Signal Level Select	<p><b>V/f</b> <b>CL-V/f</b> <b>OLV</b> <b>CLV</b> <b>AOLV</b> <b>OLV/PM</b> <b>AOLV/PM</b> <b>CLV/PM</b> <b>EZOLV</b></p> <p>Sets the MFAO terminal AM output signal level.</p> <p><b>Note:</b> Set jumper S5 on the terminal board to the correct position after changing this parameter.</p> <p>0 : 0 to 10 Vdc 1 : -10 to +10 Vdc 2 : 4 to 20 mA</p>	0 (0 - 2)	926
H4-20 (0B53)	Analog Power Monitor 100% Level	<p><b>V/f</b> <b>CL-V/f</b> <b>OLV</b> <b>CLV</b> <b>AOLV</b> <b>OLV/PM</b> <b>AOLV/PM</b> <b>CLV/PM</b> <b>EZOLV</b></p> <p>Sets the level at 10 V when U1-08 [Output Power] is set for analog output.</p>	0.00 kW (0.00 - 650.00 kW)	927

◆ H5: Modbus Communication

No. (Hex.)	Name	Description	Default (Range)	Ref.
H5-01 (0425)	Drive Node Address	<p><b>V/f</b> <b>CL-V/f</b> <b>OLV</b> <b>CLV</b> <b>AOLV</b> <b>OLV/PM</b> <b>AOLV/PM</b> <b>CLV/PM</b> <b>EZOLV</b></p> <p>Sets the communication slave address for drives.</p> <p><b>Note:</b></p> <ul style="list-style-type: none"> <li>Restart the drive after changing the parameter setting.</li> <li>Setting 0 will not let the drive respond to MEMOBUS/Modbus communications.</li> </ul>	1FH (0 - FFH)	927
H5-02 (0426)	Communication Speed Selection	<p><b>V/f</b> <b>CL-V/f</b> <b>OLV</b> <b>CLV</b> <b>AOLV</b> <b>OLV/PM</b> <b>AOLV/PM</b> <b>CLV/PM</b> <b>EZOLV</b></p> <p>Sets the communications speed for MEMOBUS/Modbus communications.</p> <p><b>Note:</b> Restart the drive after you change the parameter setting.</p> <p>0 : 1200 bps 1 : 2400 bps 2 : 4800 bps 3 : 9600 bps 4 : 19.2 kbps 5 : 38.4 kbps 6 : 57.6 kbps 7 : 76.8 kbps 8 : 115.2 kbps</p>	3 (0 - 8)	927
H5-03 (0427)	Communication Parity Selection	<p><b>V/f</b> <b>CL-V/f</b> <b>OLV</b> <b>CLV</b> <b>AOLV</b> <b>OLV/PM</b> <b>AOLV/PM</b> <b>CLV/PM</b> <b>EZOLV</b></p> <p>Sets the communications parity used for MEMOBUS/Modbus communications.</p> <p><b>Note:</b> Restart the drive after you change the parameter setting.</p> <p>0 : No parity 1 : Even parity 2 : Odd parity</p>	0 (0 - 2)	928
H5-04 (0428)	Communication Error Stop Method	<p><b>V/f</b> <b>CL-V/f</b> <b>OLV</b> <b>CLV</b> <b>AOLV</b> <b>OLV/PM</b> <b>AOLV/PM</b> <b>CLV/PM</b> <b>EZOLV</b></p> <p>Sets the motor Stopping Method when the drive detects CE [Modbus Communication Error] issues.</p> <p>0 : Ramp to Stop 1 : Coast to Stop 2 : Fast Stop (Use C1-09) 3 : Alarm Only</p>	3 (0 - 3)	928
H5-05 (0429)	Comm Fault Detection Selection	<p><b>V/f</b> <b>CL-V/f</b> <b>OLV</b> <b>CLV</b> <b>AOLV</b> <b>OLV/PM</b> <b>AOLV/PM</b> <b>CLV/PM</b> <b>EZOLV</b></p> <p>Sets the function that detects CE [Modbus Communication Error] issues during MEMOBUS/Modbus communications.</p> <p>0 : Disabled 1 : Enabled</p>	1 (0, 1)	928

No. (Hex.)	Name	Description	Default (Range)	Ref.
H5-06 (042A)	Drive Transmit Wait Time	<b>V/f</b> <b>CL-V/f</b> <b>OLV</b> <b>CLV</b> <b>AOLV</b> <b>OLV/PM</b> <b>AOLV/PM</b> <b>CLV/PM</b> <b>EZOLV</b> Sets the time to wait to send a response message after the drive receives a command message from the master. <b>Note:</b> Restart the drive after you change the parameter setting.	5 ms (0 - 65 ms)	928
H5-09 (0435)	CE Detection Time	<b>V/f</b> <b>CL-V/f</b> <b>OLV</b> <b>CLV</b> <b>AOLV</b> <b>OLV/PM</b> <b>AOLV/PM</b> <b>CLV/PM</b> <b>EZOLV</b> Sets the detection time for CE [Modbus Communication Error] issues when communication stops.	2.0 s (0.0 - 10.0 s)	929
H5-10 (0436)	Modbus Register 0025H Unit Sel	<b>V/f</b> <b>CL-V/f</b> <b>OLV</b> <b>CLV</b> <b>AOLV</b> <b>OLV/PM</b> <b>AOLV/PM</b> <b>CLV/PM</b> <b>EZOLV</b> Sets the unit of measure used for the MEMOBUS/Modbus communications monitor register 0025H (output voltage reference monitor). 0 : 0.1 V units 1 : 1 V units	0 (0, 1)	929
H5-11 (043C)	Comm ENTER Command Mode	<b>V/f</b> <b>CL-V/f</b> <b>OLV</b> <b>CLV</b> <b>AOLV</b> <b>OLV/PM</b> <b>AOLV/PM</b> <b>CLV/PM</b> <b>EZOLV</b> Sets the function to make the Enter command necessary to change parameters through MEMOBUS/Modbus communications. 0 : ENTER Command Required 1 : ENTER Command Not Required	0 (0, 1)	929
H5-12 (043D)	Run Command Method Selection	<b>V/f</b> <b>CL-V/f</b> <b>OLV</b> <b>CLV</b> <b>AOLV</b> <b>OLV/PM</b> <b>AOLV/PM</b> <b>CLV/PM</b> <b>EZOLV</b> Sets the input method for the Run command when $b1-02 = 2$ [Run Command Selection 1 = Memobus/Modbus Communications] or $b1-16 = 2$ [Run Command Selection 2 = Memobus/Modbus Communications]. 0 : FWD/Stop, REV/Stop 1 : Run/Stop, FWD/REV	0 (0, 1)	929
H5-17 (11A1) Expert	ENTER command response @CPU BUSY	<b>V/f</b> <b>CL-V/f</b> <b>OLV</b> <b>CLV</b> <b>AOLV</b> <b>OLV/PM</b> <b>AOLV/PM</b> <b>CLV/PM</b> <b>EZOLV</b> Sets operation when the EEPROM write command is sent without EEPROM write available. Usually it is not necessary to change this setting. 0 : Ignore Command(No ROM/RAM Write) 1 : Write to RAM Only	0 (0, 1)	930
H5-18 (11A2)	Motor Speed Filter over Comms	<b>V/f</b> <b>CL-V/f</b> <b>OLV</b> <b>CLV</b> <b>AOLV</b> <b>OLV/PM</b> <b>AOLV/PM</b> <b>CLV/PM</b> <b>EZOLV</b> Sets the filter time constant used when monitoring motor speed during MEMOBUS/Modbus communications or with a communication option.	0 ms (0 - 100 ms)	930
H5-20 (0B57)	Communication Parameters Reload	<b>V/f</b> <b>CL-V/f</b> <b>OLV</b> <b>CLV</b> <b>AOLV</b> <b>OLV/PM</b> <b>AOLV/PM</b> <b>CLV/PM</b> <b>EZOLV</b> Sets the function to immediately enable updated MEMOBUS/Modbus communications parameters. 0 : Reload at Next Power Cycle 1 : Reload Now	0 (0, 1)	930
H5-25 (1589) RUN	Function 5A Register 1 Selection	<b>V/f</b> <b>CL-V/f</b> <b>OLV</b> <b>CLV</b> <b>AOLV</b> <b>OLV/PM</b> <b>AOLV/PM</b> <b>CLV/PM</b> <b>EZOLV</b> Returns the contents of the specified MEMOBUS/Modbus communications register when responding to the master device.	0044H (U1-05) (0000H - FFFFH)	930
H5-26 (158A) RUN	Function 5A Register 2 Selection	<b>V/f</b> <b>CL-V/f</b> <b>OLV</b> <b>CLV</b> <b>AOLV</b> <b>OLV/PM</b> <b>AOLV/PM</b> <b>CLV/PM</b> <b>EZOLV</b> Returns the contents of the specified MEMOBUS/Modbus communications register when responding to the master device.	0045H (U1-06) (0000H - FFFFH)	930
H5-27 (158B) RUN	Function 5A Register 3 Selection	<b>V/f</b> <b>CL-V/f</b> <b>OLV</b> <b>CLV</b> <b>AOLV</b> <b>OLV/PM</b> <b>AOLV/PM</b> <b>CLV/PM</b> <b>EZOLV</b> Returns the contents of the specified MEMOBUS/Modbus communications register when responding to the master device.	0042H (U1-03) (0000H - FFFFH)	931
H5-28 (158C) RUN	Function 5A Register 4 Selection	<b>V/f</b> <b>CL-V/f</b> <b>OLV</b> <b>CLV</b> <b>AOLV</b> <b>OLV/PM</b> <b>AOLV/PM</b> <b>CLV/PM</b> <b>EZOLV</b> Returns the contents of the specified MEMOBUS/Modbus communications register when responding to the master device.	0049H (U1-10) (0000H - FFFFH)	931

◆ H6: Pulse Train Input/Output

No. (Hex.)	Name	Description	Default (Range)	Ref.
H6-01 (042C)	Terminal RP Pulse Train Function	<b>V/f</b> <b>CL-V/f</b> <b>OLV</b> <b>CLV</b> <b>AOLV</b> <b>OLV/PM</b> <b>AOLV/PM</b> <b>CLV/PM</b> <b>EZOLV</b> Sets the function for pulse train input terminal RP. 0 : Frequency Reference 1 : PID Feedback Value 2 : PID Setpoint Value 3 : Speed Feedback (V/F Control)	0 (0 - 3)	931
H6-02 (042D) RUN	Terminal RP Frequency Scaling	<b>V/f</b> <b>CL-V/f</b> <b>OLV</b> <b>CLV</b> <b>AOLV</b> <b>OLV/PM</b> <b>AOLV/PM</b> <b>CLV/PM</b> <b>EZOLV</b> Sets the frequency of the pulse train input signal used when the function set with H6-01 [Terminal RP Pulse Train Function] is 100%.	1440 Hz (100 - 32000 Hz)	932
H6-03 (042E) RUN	Terminal RP Function Gain	<b>V/f</b> <b>CL-V/f</b> <b>OLV</b> <b>CLV</b> <b>AOLV</b> <b>OLV/PM</b> <b>AOLV/PM</b> <b>CLV/PM</b> <b>EZOLV</b> Sets the gain used when the function in H6-01 [Terminal RP Pulse Train Function] is input to terminal RP.	100.0% (0.0 - 1000.0%)	932
H6-04 (042F) RUN	Terminal RP Function Bias	<b>V/f</b> <b>CL-V/f</b> <b>OLV</b> <b>CLV</b> <b>AOLV</b> <b>OLV/PM</b> <b>AOLV/PM</b> <b>CLV/PM</b> <b>EZOLV</b> Sets the bias used when the function in H6-01 [Terminal RP Pulse Train Function] is input to terminal RP. Sets a value when the pulse train is 0 Hz.	0.0% (-100.0 - 100.0%)	933
H6-05 (0430) RUN	Terminal RP Filter Time	<b>V/f</b> <b>CL-V/f</b> <b>OLV</b> <b>CLV</b> <b>AOLV</b> <b>OLV/PM</b> <b>AOLV/PM</b> <b>CLV/PM</b> <b>EZOLV</b> Sets the time constant for the primary delay filters of the pulse train input.	0.10 s (0.00 - 2.00 s)	933
H6-06 (0431) RUN	Terminal MP Monitor Selection	<b>V/f</b> <b>CL-V/f</b> <b>OLV</b> <b>CLV</b> <b>AOLV</b> <b>OLV/PM</b> <b>AOLV/PM</b> <b>CLV/PM</b> <b>EZOLV</b> Sets a function for pulse train monitor output terminal MP. Sets the "x-xx" part of the Ux-xx monitor.	102 (000, 031, 101, 102, 105, 116, 501, 502, 801 - 809, 821 - 825, 831 - 839, 851 - 855)	933
H6-07 (0432) RUN	Terminal MP Frequency Scaling	<b>V/f</b> <b>CL-V/f</b> <b>OLV</b> <b>CLV</b> <b>AOLV</b> <b>OLV/PM</b> <b>AOLV/PM</b> <b>CLV/PM</b> <b>EZOLV</b> Sets the frequency of the pulse train output signal used when the monitor set with H6-06 [Terminal MP Monitor Selection] is 100%.	1440 Hz (0 - 32000 Hz)	934
H6-08 (043F)	Terminal RP Minimum Frequency	<b>V/f</b> <b>CL-V/f</b> <b>OLV</b> <b>CLV</b> <b>AOLV</b> <b>OLV/PM</b> <b>AOLV/PM</b> <b>CLV/PM</b> <b>EZOLV</b> Sets the minimum frequency of the pulse train signal that terminal RP can detect.	0.5 Hz (0.1 - 1000.0 Hz)	934
H6-09 (156E)	Voltage Phase Sync MP Selection	<b>V/f</b> <b>CL-V/f</b> <b>OLV</b> <b>CLV</b> <b>AOLV</b> <b>OLV/PM</b> <b>AOLV/PM</b> <b>CLV/PM</b> <b>EZOLV</b> Set whether to output the pulse synchronized with drive output voltage phase from the pulse train monitor output terminal MP. This parameter is only enabled when H6-06 = 102 [Terminal MP Monitor Selection = Output Frequency] and H6-07 = 0 [Terminal MP Frequency Scaling = 0 Hz]. 0 : Disabled 1 : Enabled	0 (0, 1)	934

◆ H7: Virtual Inputs/Outputs

No. (Hex.)	Name	Description	Default (Range)	Ref.
H7-00 (116F) Expert	Virtual MFIO selection	<b>V/f</b> <b>CL-V/f</b> <b>OLV</b> <b>CLV</b> <b>AOLV</b> <b>OLV/PM</b> <b>AOLV/PM</b> <b>CLV/PM</b> <b>EZOLV</b> Sets the function to enable and disable the virtual I/O function. Set this parameter to 1 to operate the virtual I/O function. 0 : Disabled 1 : Enabled	0 (0, 1)	935
H7-01 (1185) Expert	Virtual Multi-Function Input 1	<b>V/f</b> <b>CL-V/f</b> <b>OLV</b> <b>CLV</b> <b>AOLV</b> <b>OLV/PM</b> <b>AOLV/PM</b> <b>CLV/PM</b> <b>EZOLV</b> Sets the function that enters the virtual input set in H7-10 [Virtual Multi-Function Output 1].	F (0 - 19F)	935
H7-02 (1186) Expert	Virtual Multi-Function Input 2	<b>V/f</b> <b>CL-V/f</b> <b>OLV</b> <b>CLV</b> <b>AOLV</b> <b>OLV/PM</b> <b>AOLV/PM</b> <b>CLV/PM</b> <b>EZOLV</b> Sets the function that enters the virtual input set in H7-12 [Virtual Multi-Function Output 2].	F (0 - 19F)	935

No. (Hex.)	Name	Description	Default (Range)	Ref.
H7-03 (1187) Expert	Virtual Multi-Function Input 3	<b>V/f</b> <b>CL-V/f</b> <b>OLV</b> <b>CLV</b> <b>AOLV</b> <b>OLV/PM</b> <b>AOLV/PM</b> <b>CLV/PM</b> <b>EZOLV</b> Sets the function that enters the virtual input set in H7-14 [Virtual Multi-Function Output 3].	F (0 - 19F)	935
H7-04 (1188) Expert	Virtual Multi-Function Input 4	<b>V/f</b> <b>CL-V/f</b> <b>OLV</b> <b>CLV</b> <b>AOLV</b> <b>OLV/PM</b> <b>AOLV/PM</b> <b>CLV/PM</b> <b>EZOLV</b> Sets the function that enters the virtual input set in H7-16 [Virtual Multi-Function Output 4].	F (0 - 19F)	936
H7-10 (11A4) Expert	Virtual Multi-Function Output 1	<b>V/f</b> <b>CL-V/f</b> <b>OLV</b> <b>CLV</b> <b>AOLV</b> <b>OLV/PM</b> <b>AOLV/PM</b> <b>CLV/PM</b> <b>EZOLV</b> Sets the function for virtual digital output 1.	F (0 - 1A7)	936
H7-11 (11A5) Expert	Virtual Output 1 Delay Time	<b>V/f</b> <b>CL-V/f</b> <b>OLV</b> <b>CLV</b> <b>AOLV</b> <b>OLV/PM</b> <b>AOLV/PM</b> <b>CLV/PM</b> <b>EZOLV</b> Sets the minimum ON time for virtual digital output 1.	0.1 s (0.0 - 25.0 s)	936
H7-12 (11A6) Expert	Virtual Multi-Function Output 2	<b>V/f</b> <b>CL-V/f</b> <b>OLV</b> <b>CLV</b> <b>AOLV</b> <b>OLV/PM</b> <b>AOLV/PM</b> <b>CLV/PM</b> <b>EZOLV</b> Sets the function for virtual digital output 2.	F (0 - 1A7)	936
H7-13 (11A7) Expert	Virtual Output 2 Delay Time	<b>V/f</b> <b>CL-V/f</b> <b>OLV</b> <b>CLV</b> <b>AOLV</b> <b>OLV/PM</b> <b>AOLV/PM</b> <b>CLV/PM</b> <b>EZOLV</b> Sets the minimum ON time for virtual digital output 2.	0.1 s (0.0 - 25.0 s)	936
H7-14 (11A8) Expert	Virtual Multi-Function Output 3	<b>V/f</b> <b>CL-V/f</b> <b>OLV</b> <b>CLV</b> <b>AOLV</b> <b>OLV/PM</b> <b>AOLV/PM</b> <b>CLV/PM</b> <b>EZOLV</b> Sets the function for virtual digital output 3.	F (0 - 1A7)	936
H7-15 (11A9) Expert	Virtual Output 3 Delay Time	<b>V/f</b> <b>CL-V/f</b> <b>OLV</b> <b>CLV</b> <b>AOLV</b> <b>OLV/PM</b> <b>AOLV/PM</b> <b>CLV/PM</b> <b>EZOLV</b> Sets the minimum ON time for virtual digital output 3.	0.1 s (0.0 - 25.0 s)	936
H7-16 (11AA) Expert	Virtual Multi-Function Output 4	<b>V/f</b> <b>CL-V/f</b> <b>OLV</b> <b>CLV</b> <b>AOLV</b> <b>OLV/PM</b> <b>AOLV/PM</b> <b>CLV/PM</b> <b>EZOLV</b> Sets the function for virtual digital output 4.	F (0 - 1A7)	937
H7-17 (11AB) Expert	Virtual Output 4 Delay Time	<b>V/f</b> <b>CL-V/f</b> <b>OLV</b> <b>CLV</b> <b>AOLV</b> <b>OLV/PM</b> <b>AOLV/PM</b> <b>CLV/PM</b> <b>EZOLV</b> Sets the minimum ON time for virtual digital output 4.	0.1 s (0.0 - 25.0 s)	937
H7-30 (1177)	Virtual Analog Input Selection	<b>V/f</b> <b>CL-V/f</b> <b>OLV</b> <b>CLV</b> <b>AOLV</b> <b>OLV/PM</b> <b>AOLV/PM</b> <b>CLV/PM</b> <b>EZOLV</b> Sets the virtual analog input function.	F (0 - 32)	937
H7-31 (1178) RUN Expert	Virtual Analog Input Gain	<b>V/f</b> <b>CL-V/f</b> <b>OLV</b> <b>CLV</b> <b>AOLV</b> <b>OLV/PM</b> <b>AOLV/PM</b> <b>CLV/PM</b> <b>EZOLV</b> Sets the virtual analog input gain.	100.0% (-999.9 - 999.9%)	937
H7-32 (1179) RUN Expert	Virtual Analog Input Bias	<b>V/f</b> <b>CL-V/f</b> <b>OLV</b> <b>CLV</b> <b>AOLV</b> <b>OLV/PM</b> <b>AOLV/PM</b> <b>CLV/PM</b> <b>EZOLV</b> Sets the virtual analog input bias.	0.0% (-999.9 - 999.9%)	937
H7-40 (1163)	Virtual Analog Out Signal Select	<b>V/f</b> <b>CL-V/f</b> <b>OLV</b> <b>CLV</b> <b>AOLV</b> <b>OLV/PM</b> <b>AOLV/PM</b> <b>CLV/PM</b> <b>EZOLV</b> Sets the signal level of the virtual analog output. 0 : 0 to 100% (Absolute Value) 1 : -100 to 100% 2 : 0 to 100% (Lower Limit at 0)	0 (0 - 2)	937
H7-41 (1164)	Virtual Analog Output Function	<b>V/f</b> <b>CL-V/f</b> <b>OLV</b> <b>CLV</b> <b>AOLV</b> <b>OLV/PM</b> <b>AOLV/PM</b> <b>CLV/PM</b> <b>EZOLV</b> Sets the monitor to be output from the virtual analog output. Set the x-xx part of the Ux-xx [Monitor]. For example, set x-xx to 102 to monitor U1-02 [Output Frequency].	102 (0 - 999)	937
H7-42 (1165)	Virtual Analog Output Filter Time	<b>V/f</b> <b>CL-V/f</b> <b>OLV</b> <b>CLV</b> <b>AOLV</b> <b>OLV/PM</b> <b>AOLV/PM</b> <b>CLV/PM</b> <b>EZOLV</b> Sets the time constant for a primary filter of the virtual analog output.	0.00 s (0.00 - 2.00 s)	938

## 10.11 L: Protection Functions

### ◆ L1: Motor Protection

No. (Hex.)	Name	Description	Default (Range)	Ref.
L1-01 (0480)	Motor Overload (oL1) Protection	<p><input type="checkbox"/>V/f <input type="checkbox"/>CL-V/f <input type="checkbox"/>OLV <input type="checkbox"/>CLV <input type="checkbox"/>AOLV <input type="checkbox"/>OLV/PM <input type="checkbox"/>AOLV/PM <input type="checkbox"/>CLV/PM <input type="checkbox"/>EZOLV</p> <p>Sets the motor overload protection with electronic thermal protectors.</p> <p>0 : Disabled 1 : Variable Torque 2 : Constant Torque 10:1 Speed Range 3 : Constant Torque 100:1 SpeedRange 4 : PM Variable Torque 5 : PM Constant Torque 6 : Variable Torque (50Hz)</p> <p><b>Note:</b> When only one motor is connected to a drive, set <i>L1-01 = 1 to 6 [Enabled]</i>. External thermal relays are not necessary in these conditions.</p>	Determined by A1-02 (0 - 6)	277
L1-02 (0481)	Motor Overload Protection Time	<p><input type="checkbox"/>V/f <input type="checkbox"/>CL-V/f <input type="checkbox"/>OLV <input type="checkbox"/>CLV <input type="checkbox"/>AOLV <input type="checkbox"/>OLV/PM <input type="checkbox"/>AOLV/PM <input type="checkbox"/>CLV/PM <input type="checkbox"/>EZOLV</p> <p>Sets the operation time for the electronic thermal protector of the drive to prevent damage to the motor. Usually it is not necessary to change this setting.</p>	1.0 min (0.1 - 5.0 min)	280
L1-03 (0482)	Motor Thermistor oH Alarm Select	<p><input type="checkbox"/>V/f <input type="checkbox"/>CL-V/f <input type="checkbox"/>OLV <input type="checkbox"/>CLV <input type="checkbox"/>AOLV <input type="checkbox"/>OLV/PM <input type="checkbox"/>AOLV/PM <input type="checkbox"/>CLV/PM <input type="checkbox"/>EZOLV</p> <p>Sets drive operation when the PTC input signal entered into the drive is at the <i>oH3 [Motor Overheat Alarm]</i> detection level.</p> <p>0 : Ramp to Stop 1 : Coast to Stop 2 : Fast Stop (Use C1-09) 3 : Alarm Only</p>	3 (0 - 3)	281
L1-04 (0483)	Motor Thermistor oH Fault Select	<p><input type="checkbox"/>V/f <input type="checkbox"/>CL-V/f <input type="checkbox"/>OLV <input type="checkbox"/>CLV <input type="checkbox"/>AOLV <input type="checkbox"/>OLV/PM <input type="checkbox"/>AOLV/PM <input type="checkbox"/>CLV/PM <input type="checkbox"/>EZOLV</p> <p>Sets the drive operation when the PTC input signal to the drive is at the <i>oH4 [Motor Overheat Fault (PTC Input)]</i> detection level.</p> <p>0 : Ramp to Stop 1 : Coast to Stop 2 : Fast Stop (Use C1-09)</p>	1 (0 - 2)	281
L1-05 (0484)	Motor Thermistor Filter Time	<p><input type="checkbox"/>V/f <input type="checkbox"/>CL-V/f <input type="checkbox"/>OLV <input type="checkbox"/>CLV <input type="checkbox"/>AOLV <input type="checkbox"/>OLV/PM <input type="checkbox"/>AOLV/PM <input type="checkbox"/>CLV/PM <input type="checkbox"/>EZOLV</p> <p>Sets the primary delay time constant for the PTC input signal entered to the drive. This parameter prevents accidental motor overheat faults.</p>	0.20 s (0.00 - 10.00 s)	944
L1-08 (1103)	oL1 Current Level	<p><input type="checkbox"/>V/f <input type="checkbox"/>CL-V/f <input type="checkbox"/>OLV <input type="checkbox"/>CLV <input type="checkbox"/>AOLV <input type="checkbox"/>OLV/PM <input type="checkbox"/>AOLV/PM <input type="checkbox"/>CLV/PM <input type="checkbox"/>EZOLV</p> <p>Sets the reference current for the motor 1 thermal overload detection.</p> <p><b>Note:</b> When the current level &gt; 0.0 A, you cannot set this value &lt; 10% of drive rated current.</p>	0.0 A (0.0 A or 10% to 150% of the drive rated current)	944
L1-09 (1104)	oL1 Current Level for Motor 2	<p><input type="checkbox"/>V/f <input type="checkbox"/>CL-V/f <input type="checkbox"/>OLV <input type="checkbox"/>CLV <input type="checkbox"/>AOLV <input type="checkbox"/>OLV/PM <input type="checkbox"/>AOLV/PM <input type="checkbox"/>CLV/PM <input type="checkbox"/>EZOLV</p> <p>Sets the reference current for the motor 2 thermal overload detection.</p> <p><b>Note:</b> When the current level &gt; 0.0 A, you cannot set this value &lt; 10% of drive rated current.</p>	0.0 A (0.0 A or 10 to 150% of the drive rated current)	945
L1-13 (046D)	Motor Overload Memory Selection	<p><input type="checkbox"/>V/f <input type="checkbox"/>CL-V/f <input type="checkbox"/>OLV <input type="checkbox"/>CLV <input type="checkbox"/>AOLV <input type="checkbox"/>OLV/PM <input type="checkbox"/>AOLV/PM <input type="checkbox"/>CLV/PM <input type="checkbox"/>EZOLV</p> <p>Sets the function that keeps the current electronic thermal protector value when the drive stops receiving power.</p> <p>0 : Disabled 1 : Enabled</p>	1 (0, 1)	945



## ◆ L2: Power Loss Ride Through

No. (Hex.)	Name	Description	Default (Range)	Ref.
L2-01 (0485)	Power Loss Ride Through Select	<p><b>V/f</b> <b>CL-V/f</b> <b>OLV</b> <b>CLV</b> <b>AOLV</b> <b>OLV/PM</b> <b>AOLV/PM</b> <b>CLV/PM</b> <b>EZOLV</b></p> <p>Sets the drive operation after a momentary power loss.            0 : Disabled            1 : Enabled for L2-02 Time            2 : Enabled while CPU Power Active            3 : Kinetic Energy Backup: L2-02            4 : Kinetic Energy Backup: CPU Power            5 : Kinetic Energy Backup: DecelStop</p>	0 (0 - 5)	951
L2-02 (0486)	Power Loss Ride Through Time	<p><b>V/f</b> <b>CL-V/f</b> <b>OLV</b> <b>CLV</b> <b>AOLV</b> <b>OLV/PM</b> <b>AOLV/PM</b> <b>CLV/PM</b> <b>EZOLV</b></p> <p>Sets the maximum time that the drive will wait until trying to restart after power loss.</p>	Determined by o2-04 and C6-01 (0.0 - 25.5 s)	952
L2-03 (0487)	Minimum Baseblock Time	<p><b>V/f</b> <b>CL-V/f</b> <b>OLV</b> <b>CLV</b> <b>AOLV</b> <b>OLV/PM</b> <b>AOLV/PM</b> <b>CLV/PM</b> <b>EZOLV</b></p> <p>Sets the minimum baseblock time when the drive restores power after a momentary power loss.</p>	Determined by o2-04 and C6-01 (0.1 - 5.0 s)	952
L2-04 (0488)	Powerloss V/f Recovery Ramp Time	<p><b>V/f</b> <b>CL-V/f</b> <b>OLV</b> <b>CLV</b> <b>AOLV</b> <b>OLV/PM</b> <b>AOLV/PM</b> <b>CLV/PM</b> <b>EZOLV</b></p> <p>Sets the time for the drive output voltage to go back to correct voltage after completing speed searches.</p>	Determined by o2-04 and C6-01 (0.0 - 5.0 s)	952
L2-05 (0489)	Undervoltage Detection Lvl (Uv1)	<p><b>V/f</b> <b>CL-V/f</b> <b>OLV</b> <b>CLV</b> <b>AOLV</b> <b>OLV/PM</b> <b>AOLV/PM</b> <b>CLV/PM</b> <b>EZOLV</b></p> <p>Sets the voltage at which a <i>Uv1 [DC Bus Undervoltage]</i> fault is triggered or at which the KEB function is activated. Usually it is not necessary to change this setting.</p> <p><b>NOTICE: Damage to Equipment.</b> Install an AC reactor option on the input side of the power supply when setting this parameter lower than the default value. Failure to obey will cause damage to drive circuitry.</p>	Determined by E1-01 (Determined by E1-01)	952
L2-06 (048A) Expert	Kinetic Energy Backup Decel Time	<p><b>V/f</b> <b>CL-V/f</b> <b>OLV</b> <b>CLV</b> <b>AOLV</b> <b>OLV/PM</b> <b>AOLV/PM</b> <b>CLV/PM</b> <b>EZOLV</b></p> <p>Sets the deceleration time during KEB operation used to decrease the maximum output frequency to 0.</p> <p><b>Note:</b>            When L2-29 = 1, 2, 3 [Kinetic Energy Backup Method = Single Drive KEB Ride-Thru 2, System KEB Ride-Thru 1, System KEB Ride-Thru 2] and you do KEB Auto-Tuning, the drive will automatically set this value.</p>	0.0 s (0.0 to 6000.0 s)	953
L2-07 (048B) Expert	Kinetic Energy Backup Accel Time	<p><b>V/f</b> <b>CL-V/f</b> <b>OLV</b> <b>CLV</b> <b>AOLV</b> <b>OLV/PM</b> <b>AOLV/PM</b> <b>CLV/PM</b> <b>EZOLV</b></p> <p>Sets the acceleration time to return the frequency to the frequency reference before a power loss after canceling KEB operation.</p>	0.0 s (0.0 to 6000.0 s)	953
L2-08 (048C) Expert	Frequency Gain at KEB Start	<p><b>V/f</b> <b>CL-V/f</b> <b>OLV</b> <b>CLV</b> <b>AOLV</b> <b>OLV/PM</b> <b>AOLV/PM</b> <b>CLV/PM</b> <b>EZOLV</b></p> <p>Sets the quantity of output frequency reduction used when KEB operation starts as a percentage of the motor rated slip before starting KEB operation.</p>	100% (0 - 300%)	953
L2-09 (048D) Expert	KEB Minimum Frequency Level	<p><b>V/f</b> <b>CL-V/f</b> <b>OLV</b> <b>CLV</b> <b>AOLV</b> <b>OLV/PM</b> <b>AOLV/PM</b> <b>CLV/PM</b> <b>EZOLV</b></p> <p>Sets the quantity of output frequency reduction used when KEB operation starts as a percentage of the motor rated slip.</p>	20% (0 - 100%)	954
L2-10 (048E) Expert	Minimum KEB Time	<p><b>V/f</b> <b>CL-V/f</b> <b>OLV</b> <b>CLV</b> <b>AOLV</b> <b>OLV/PM</b> <b>AOLV/PM</b> <b>CLV/PM</b> <b>EZOLV</b></p> <p>Sets the minimum length of time to operate the KEB after the drive detects a momentary power loss.</p>	50 ms (0 - 25500 ms)	954
L2-11 (0461) Expert	KEB DC Bus Voltage Setpoint	<p><b>V/f</b> <b>CL-V/f</b> <b>OLV</b> <b>CLV</b> <b>AOLV</b> <b>OLV/PM</b> <b>AOLV/PM</b> <b>CLV/PM</b> <b>EZOLV</b></p> <p>Sets the target value that controls the DC bus voltage to a constant level in Single Drive KEB Ride-Thru 2. Sets the DC bus voltage level that completes the KEB operation for all other KEB methods.</p>	Determined by E1-01 (Determined by E1-01)	954
L2-29 (0475) Expert	Kinetic Energy Backup Method	<p><b>V/f</b> <b>CL-V/f</b> <b>OLV</b> <b>CLV</b> <b>AOLV</b> <b>OLV/PM</b> <b>AOLV/PM</b> <b>CLV/PM</b> <b>EZOLV</b></p> <p>Sets the KEB function operation mode.            0 : Single Drive KEB Ride-Thru 1            1 : Single Drive KEB Ride-Thru 2            2 : System KEB Ride-Thru 1            3 : System KEB Ride-Thru 2</p>	0 (0 - 3)	954

No. (Hex.)	Name	Description	Default (Range)	Ref.
L2-30 (045E) Expert	KEB Zero Speed Operation	<p><b>V/f</b> <b>CL-V/f</b> <b>OLV</b> <b>CLV</b> <b>AOLV</b> <b>OLV/PM</b> <b>AOLV/PM</b> <b>CLV/PM</b> <b>EZOLV</b></p> <p>Sets the operation when the output frequency decreases below the zero level (DC braking injection starting frequency) during <i>KEB deceleration when L2-01 = 3 to 5 [Momentary Power Loss Ope Select = KEB Mode, KEB Stop Mode, or KEB Decel to Stp]</i>.</p> <p>0 : Baseblock 1 : DC/SC Braking</p>	0 (0, 1)	955
L2-31 (045D) Expert	KEB Start Voltage Offset Level	<p><b>V/f</b> <b>CL-V/f</b> <b>OLV</b> <b>CLV</b> <b>AOLV</b> <b>OLV/PM</b> <b>AOLV/PM</b> <b>CLV/PM</b> <b>EZOLV</b></p> <p>Sets the KEB start voltage offset.</p>	Determined by A1-02 (200 V Class: 0 - 100 V, 400 V Class: 0 - 200 V)	955

### ◆ L3: Stall Prevention

No. (Hex.)	Name	Description	Default (Range)	Ref.
L3-01 (048F)	Stall Prevention during Accel	<p><b>V/f</b> <b>CL-V/f</b> <b>OLV</b> <b>CLV</b> <b>AOLV</b> <b>OLV/PM</b> <b>AOLV/PM</b> <b>CLV/PM</b> <b>EZOLV</b></p> <p>Sets the method of the Stall Prevention During Acceleration.</p> <p>0 : Disabled 1 : Enabled 2 : Intelligent (Ignore Accel Ramp) 3 : Current Limit Method</p>	1 (0 - 3)	956
L3-02 (0490)	Stall Prevent Level during Accel	<p><b>V/f</b> <b>CL-V/f</b> <b>OLV</b> <b>CLV</b> <b>AOLV</b> <b>OLV/PM</b> <b>AOLV/PM</b> <b>CLV/PM</b> <b>EZOLV</b></p> <p>Sets the output current level to start Stall Prevention during acceleration as a percentage of the drive rated output current.</p>	Determined by C6-01 and L8-38 (0 - 150%)	958
L3-03 (0491)	Stall Prevent Limit during Accel	<p><b>V/f</b> <b>CL-V/f</b> <b>OLV</b> <b>CLV</b> <b>AOLV</b> <b>OLV/PM</b> <b>AOLV/PM</b> <b>CLV/PM</b> <b>EZOLV</b></p> <p>Sets the lower limit for the stall prevention level during acceleration used for constant output ranges as a percentage of the drive rated output current.</p>	50% (0 - 100%)	958
L3-04 (0492)	Stall Prevention during Decel	<p><b>V/f</b> <b>CL-V/f</b> <b>OLV</b> <b>CLV</b> <b>AOLV</b> <b>OLV/PM</b> <b>AOLV/PM</b> <b>CLV/PM</b> <b>EZOLV</b></p> <p>Sets the method that the drive will use to prevent overvoltage faults when decelerating.</p> <p><b>Note:</b></p> <ol style="list-style-type: none"> <li>To connect a dynamic braking option (braking resistor or braking resistor unit) to the drive, set this parameter to 0 or 3. Parameter values 1, 2, 4, and 5 will enable Stall Prevention function during deceleration, and the dynamic braking option will not function.</li> <li>The setting range changes when the A1-02 [Control Method Selection] value changes: <ul style="list-style-type: none"> <li>When A1-02 = 5 [PM Open Loop Vector], setting range is 0 to 2</li> <li>When A1-02 = 6, 7, or 8 [PM Advanced Open Loop Vector; PM Closed Loop Vector; or EZ Vector Control], setting range is 0, 1.</li> </ul> </li> </ol> <p>0 : Disabled 1 : General Purpose 2 : Intelligent (Ignore Decel Ramp) 3 : General Purpose w/ DB resistor 4 : Overexcitation/High Flux 5 : Overexcitation/High Flux 2</p>	1 (Determined by A1-02)	958
L3-05 (0493)	Stall Prevention during RUN	<p><b>V/f</b> <b>CL-V/f</b> <b>OLV</b> <b>CLV</b> <b>AOLV</b> <b>OLV/PM</b> <b>AOLV/PM</b> <b>CLV/PM</b> <b>EZOLV</b></p> <p>Sets the function to enable and disable Stall Prevention During Run.</p> <p><b>Note:</b></p> <p>An output frequency less than 6 Hz will disable Stall Prevention during Run regardless of L3-05 and L3-06 [Stall Prevent Level during Run] settings.</p> <p>0 : Disabled 1 : Deceleration Time 1 (C1-02) 2 : Deceleration Time 2 (C1-04) 3 : Intelligent</p>	Determined by A1-02 (0 - Determined by A1-02)	960

No. (Hex.)	Name	Description	Default (Range)	Ref.
L3-06 (0494)	Stall Prevent Level during Run	<p><b>V/f</b> <b>CL-V/f</b> <b>OLV</b> <b>CLV</b> <b>AOLV</b> <b>OLV/PM</b> <b>AOLV/PM</b> <b>CLV/PM</b> <b>EZOLV</b></p> <p>Sets the current level that starts Stall Prevention during run. A setting of 100% is equal to the drive rated current.</p> <p><b>Note:</b> This parameter is applicable if <i>L3-05 = 1, 2 [Stall Prevention during RUN = Deceleration Time 1 (C1-02), Deceleration Time 2 (C1-04)]</i>.</p>	Determined by C6-01 and L8-38 (30 - 150%)	960
L3-11 (04C7)	Overvoltage Suppression Select	<p><b>V/f</b> <b>CL-V/f</b> <b>OLV</b> <b>CLV</b> <b>AOLV</b> <b>OLV/PM</b> <b>AOLV/PM</b> <b>CLV/PM</b> <b>EZOLV</b></p> <p>Sets the overvoltage suppression function.</p> <p>0 : Disabled 1 : Enabled</p>	0 (0, 1)	961
L3-17 (0462)	DC Bus Regulation Level	<p><b>V/f</b> <b>CL-V/f</b> <b>OLV</b> <b>CLV</b> <b>AOLV</b> <b>OLV/PM</b> <b>AOLV/PM</b> <b>CLV/PM</b> <b>EZOLV</b></p> <p>Sets the target value for the DC bus voltage when the overvoltage suppression function and the Decel Stall Prevention function (Intelligent Stall Prevention) are active.</p>	200 V Class: 375 V, 400 V Class: 750 V (200 V Class: 150 - 400 V, 400 V Class: 300 - 800 V)	961
L3-20 (0465) Expert	DC Bus Voltage Adjustment Gain	<p><b>V/f</b> <b>CL-V/f</b> <b>OLV</b> <b>CLV</b> <b>AOLV</b> <b>OLV/PM</b> <b>AOLV/PM</b> <b>CLV/PM</b> <b>EZOLV</b></p> <p>Sets the proportional gain used to control the DC bus voltage.</p>	Determined by A1-02 (0.00 - 5.00)	961
L3-21 (0466) Expert	OVSUPPRESSION Accel/Decel P Gain	<p><b>V/f</b> <b>CL-V/f</b> <b>OLV</b> <b>CLV</b> <b>AOLV</b> <b>OLV/PM</b> <b>AOLV/PM</b> <b>CLV/PM</b> <b>EZOLV</b></p> <p>Sets the proportional gain to calculate acceleration and deceleration rates.</p>	Determined by A1-02 (0.10 - 10.00)	962
L3-22 (04F9)	PM Stall Prevention Decel Time	<p><b>V/f</b> <b>CL-V/f</b> <b>OLV</b> <b>CLV</b> <b>AOLV</b> <b>OLV/PM</b> <b>AOLV/PM</b> <b>CLV/PM</b> <b>EZOLV</b></p> <p>Sets the momentary deceleration time that the drive will use when it tries to accelerate a PM motor and detected motor stalls. This function is applicable when <i>L3-01 = 1 [Stall Prevent Select during Accel = General Purpose]</i>.</p>	0.0 s (0.0 - 6000.0 s)	962
L3-23 (04FD)	Stall P Reduction at Constant HP	<p><b>V/f</b> <b>CL-V/f</b> <b>OLV</b> <b>CLV</b> <b>AOLV</b> <b>OLV/PM</b> <b>AOLV/PM</b> <b>CLV/PM</b> <b>EZOLV</b></p> <p>Sets the function to automatically decrease the Stall Prevention Level during Run for constant output ranges.</p> <p>0 : Use L3-06 for Entire Speed Range 1 : Automatic Reduction @ CHP Region</p>	0 (0, 1)	962
L3-24 (046E) Expert	Motor Accel Time @ Rated Torque	<p><b>V/f</b> <b>CL-V/f</b> <b>OLV</b> <b>CLV</b> <b>AOLV</b> <b>OLV/PM</b> <b>AOLV/PM</b> <b>CLV/PM</b> <b>EZOLV</b></p> <p>Sets the motor acceleration time to reach the maximum frequency at the motor rated torque for stopped single-drive motors.</p>	Determined by o2-04, C6-01, E2-11, and E5-01 (0.001 - 10.000 s)	962
L3-25 (046F) Expert	Load Inertia Ratio	<p><b>V/f</b> <b>CL-V/f</b> <b>OLV</b> <b>CLV</b> <b>AOLV</b> <b>OLV/PM</b> <b>AOLV/PM</b> <b>CLV/PM</b> <b>EZOLV</b></p> <p>Sets the ratio between motor inertia and machine inertia.</p>	1.0 (1.0 - 1000.0)	963
L3-26 (0455) Expert	Additional DC Bus Capacitors	<p><b>V/f</b> <b>CL-V/f</b> <b>OLV</b> <b>CLV</b> <b>AOLV</b> <b>OLV/PM</b> <b>AOLV/PM</b> <b>CLV/PM</b> <b>EZOLV</b></p> <p>Sets the capacity for external main circuit capacitors. Sets this parameter when you use the KEB Ride-Thru function. Usually it is not necessary to change this setting.</p>	0 μF (0 to 65000 μF)	963
L3-27 (0456)	Stall Prevention Detection Time	<p><b>V/f</b> <b>CL-V/f</b> <b>OLV</b> <b>CLV</b> <b>AOLV</b> <b>OLV/PM</b> <b>AOLV/PM</b> <b>CLV/PM</b> <b>EZOLV</b></p> <p>Sets a delay time between reaching the Stall Prevention level and starting the Stall Prevention function.</p>	50 ms (0 - 5000 ms)	964
L3-34 (016F) Expert	Torque Limit Delay Time	<p><b>V/f</b> <b>CL-V/f</b> <b>OLV</b> <b>CLV</b> <b>AOLV</b> <b>OLV/PM</b> <b>AOLV/PM</b> <b>CLV/PM</b> <b>EZOLV</b></p> <p>Sets the filter time constant that returns the torque limit to its initial value when KEB operation operates in Single Drive KEB Ride-Thru mode.</p>	Determined by A1-02 (0.000 - 1.000 s)	964
L3-35 (0747) Expert	Speed Agree Width for Auto Decel	<p><b>V/f</b> <b>CL-V/f</b> <b>OLV</b> <b>CLV</b> <b>AOLV</b> <b>OLV/PM</b> <b>AOLV/PM</b> <b>CLV/PM</b> <b>EZOLV</b></p> <p>Sets the width for speed agreement when <i>L3-04 = 2 [Decel Stall Prevention Selection = Automatic Decel Reduction]</i>. Usually it is not necessary to change this setting.</p>	0.00 Hz (0.00 - 1.00 Hz)	964
L3-36 (11D0)	Current Suppression Gain@Accel	<p><b>V/f</b> <b>CL-V/f</b> <b>OLV</b> <b>CLV</b> <b>AOLV</b> <b>OLV/PM</b> <b>AOLV/PM</b> <b>CLV/PM</b> <b>EZOLV</b></p> <p>Sets the gain to suppress current and motor speed hunting during operation when <i>L3-01 = 3 [Stall Prevention during Accel = Current Limit Method]</i>. Usually it is not necessary to change this setting.</p>	Determined by A1-02 (0.0 - 100.0)	964

No. (Hex.)	Name	Description	Default (Range)	Ref.
L3-37 (11D1) Expert	Current Limit P Gain @ Accel	<b>V/f</b> <b>CL-V/f</b> <b>OLV</b> <b>CLV</b> <b>AOLV</b> <b>OLV/PM</b> <b>AOLV/PM</b> <b>CLV/PM</b> <b>EZOLV</b> Usually it is not necessary to change this setting.	5 ms (0 - 100 ms)	964
L3-38 (11D2) Expert	Current Limit I Time @ Accel	<b>V/f</b> <b>CL-V/f</b> <b>OLV</b> <b>CLV</b> <b>AOLV</b> <b>OLV/PM</b> <b>AOLV/PM</b> <b>CLV/PM</b> <b>EZOLV</b> Suppresses current hunting and overshooting that occurs when the drive stalls during acceleration. Usually it is not necessary to change this setting.	10.0 (0.0 - 100.0)	964
L3-39 (11D3)	Current Limit Filter Time @Accel	<b>V/f</b> <b>CL-V/f</b> <b>OLV</b> <b>CLV</b> <b>AOLV</b> <b>OLV/PM</b> <b>AOLV/PM</b> <b>CLV/PM</b> <b>EZOLV</b> Sets the time constant to adjust the acceleration rate when L3-01 = 3 [Stall Prevention during Accel = Current Limit Method]. Usually it is not necessary to change this setting.	100.0 ms (1.0 - 1000.0 ms)	965
L3-40 (11D4)	Current Limit S-Curve @ Acc/Dec	<b>V/f</b> <b>CL-V/f</b> <b>OLV</b> <b>CLV</b> <b>AOLV</b> <b>OLV/PM</b> <b>AOLV/PM</b> <b>CLV/PM</b> <b>EZOLV</b> Sets the function to enable and disable the best S-curve characteristic used for current-limited acceleration. 0 : Disabled 1 : Enabled	0 (0, 1)	965

◆ L4: Speed Detection

No. (Hex.)	Name	Description	Default (Range)	Ref.
L4-01 (0499)	Speed Agree Detection Level	<b>V/f</b> <b>CL-V/f</b> <b>OLV</b> <b>CLV</b> <b>AOLV</b> <b>OLV/PM</b> <b>AOLV/PM</b> <b>CLV/PM</b> <b>EZOLV</b> Sets the level to detect speed agree or motor speed. Sets the level to detect speed agree or motor speed when H2-01 to H2-03 = 2, 3, 4, 5 [MFDO Function Select = Speed Agree 1, User-set Speed Agree 1, Frequency Detection 1, Frequency Detection 2].	Determined by A1-02 (Determined by A1-02)	965
L4-02 (049A)	Speed Agree Detection Width	<b>V/f</b> <b>CL-V/f</b> <b>OLV</b> <b>CLV</b> <b>AOLV</b> <b>OLV/PM</b> <b>AOLV/PM</b> <b>CLV/PM</b> <b>EZOLV</b> Sets the width to detect speed agree or motor speed. Sets the width to detect speed agree or motor speed when H2-01 to H2-03 = 2, 3, 4, 5 [MFDO Function Select = Speed Agree 1, User-set Speed Agree 1, Frequency Detection 1, Frequency Detection 2].	Determined by A1-02 (Determined by A1-02)	965
L4-03 (049B)	Speed Agree Detection Level (+/-)	<b>V/f</b> <b>CL-V/f</b> <b>OLV</b> <b>CLV</b> <b>AOLV</b> <b>OLV/PM</b> <b>AOLV/PM</b> <b>CLV/PM</b> <b>EZOLV</b> Sets the level to detect speed agree or motor speed. Sets the level to detect speed agree or motor speed when H2-01 to H2-03 = 13, 14, 15, 16 [MFDO Function Select = Speed Agree 2, User-set Speed Agree 2, Frequency Detection 3, Frequency Detection 4].	Determined by A1-02 (Determined by A1-02)	966
L4-04 (049C)	Speed Agree Detection Width (+/-)	<b>V/f</b> <b>CL-V/f</b> <b>OLV</b> <b>CLV</b> <b>AOLV</b> <b>OLV/PM</b> <b>AOLV/PM</b> <b>CLV/PM</b> <b>EZOLV</b> Sets the width to detect speed agree or motor speed. Sets the width to detect speed agree or motor speed when H2-01 to H2-03 = 13, 14, 15, 16 [MFDO Function Select = Speed Agree 2, User-set Speed Agree 2, Frequency Detection 3, Frequency Detection 4].	Determined by A1-02 (Determined by A1-02)	966
L4-05 (049D)	Fref Loss Detection Selection	<b>V/f</b> <b>CL-V/f</b> <b>OLV</b> <b>CLV</b> <b>AOLV</b> <b>OLV/PM</b> <b>AOLV/PM</b> <b>CLV/PM</b> <b>EZOLV</b> Sets the operation when the drive detects a loss of frequency reference. 0 : Stop 1 : Run at (L4-06 x Last Reference)	0 (0, 1)	966
L4-06 (04C2)	Frequency Reference @Loss of Ref	<b>V/f</b> <b>CL-V/f</b> <b>OLV</b> <b>CLV</b> <b>AOLV</b> <b>OLV/PM</b> <b>AOLV/PM</b> <b>CLV/PM</b> <b>EZOLV</b> Sets the frequency reference as a percentage to continue drive operation after it detects a frequency reference loss. The value is a percentage of the frequency reference before the drive detected the loss.	80.0% (0.0 - 100.0%)	966
L4-07 (0470)	Speed Agree Detection Selection	<b>V/f</b> <b>CL-V/f</b> <b>OLV</b> <b>CLV</b> <b>AOLV</b> <b>OLV/PM</b> <b>AOLV/PM</b> <b>CLV/PM</b> <b>EZOLV</b> Sets the condition that activates speed detection. 0 : No Detection during Baseblock 1 : Detection Always Enabled	0 (0, 1)	967

### ◆ L5: Fault Restart

No. (Hex.)	Name	Description	Default (Range)	Ref.
L5-01 (049E)	Number of Auto-Restart Attempts	<b>V/f</b> <b>CL-V/f</b> <b>OLV</b> <b>CLV</b> <b>AOLV</b> <b>OLV/PM</b> <b>AOLV/PM</b> <b>CLV/PM</b> <b>EZOLV</b> Sets the number of times that the drive will try to restart.	0 (0 - 10 times)	967
L5-02 (049F)	Fault Contact at Restart Select	<b>V/f</b> <b>CL-V/f</b> <b>OLV</b> <b>CLV</b> <b>AOLV</b> <b>OLV/PM</b> <b>AOLV/PM</b> <b>CLV/PM</b> <b>EZOLV</b> Sets the function that sends signals to the MFDO terminal set for <i>Fault [H2-xx = E]</i> while the drive is automatically restarting. 0 : Active Only when Not Restarting 1 : Always Active	0 (0, 1)	968
L5-04 (046C)	Interval Method Restart Time	<b>V/f</b> <b>CL-V/f</b> <b>OLV</b> <b>CLV</b> <b>AOLV</b> <b>OLV/PM</b> <b>AOLV/PM</b> <b>CLV/PM</b> <b>EZOLV</b> Sets the time interval between each Auto Restart attempt. Set L5-05 = 1 [ <i>Auto-Restart Method = Continuous/Immediate Attempts</i> ] to enable this function.	10.0 s (0.5 - 600.0 s)	968
L5-05 (0467)	Auto-Restart Method	<b>V/f</b> <b>CL-V/f</b> <b>OLV</b> <b>CLV</b> <b>AOLV</b> <b>OLV/PM</b> <b>AOLV/PM</b> <b>CLV/PM</b> <b>EZOLV</b> Sets the count method for the Auto Restart operation. 0 : Continuous/Immediate Attempts 1 : Interval/Attempt after L5-04 sec	0 (0, 1)	968
L5-07 (0B2A)	Fault Reset Enable Select Grp1	<b>V/f</b> <b>CL-V/f</b> <b>OLV</b> <b>CLV</b> <b>AOLV</b> <b>OLV/PM</b> <b>AOLV/PM</b> <b>CLV/PM</b> <b>EZOLV</b> Use these 4 digits to set the Auto Restart function for <i>oL1</i> to <i>oL4</i> . From left to right, the digits set <i>oL1</i> , <i>oL2</i> , <i>oL3</i> , and <i>oL4</i> , in order. 0 : Disabled 1 : Enabled(—/—/—/—/oL4)	1111 (0000 - 1111)	968
L5-08 (0B2B)	Fault Reset Enable Select Grp2	<b>V/f</b> <b>CL-V/f</b> <b>OLV</b> <b>CLV</b> <b>AOLV</b> <b>OLV/PM</b> <b>AOLV/PM</b> <b>CLV/PM</b> <b>EZOLV</b> Use these 4 digits to set the Auto Restart function for <i>Uv1</i> , <i>ov</i> , <i>oHI</i> , and <i>GF</i> . From left to right, the digits set <i>Uv1</i> , <i>ov</i> , <i>oHI</i> , and <i>GF</i> , in order. 0 : Disabled 1 : Enabled(—/—/—/—/GF)	1111 (0000 - 1111)	968

### ◆ L6: Torque Detection

No. (Hex.)	Name	Description	Default (Range)	Ref.
L6-01 (04A1)	Torque Detection Selection 1	<b>V/f</b> <b>CL-V/f</b> <b>OLV</b> <b>CLV</b> <b>AOLV</b> <b>OLV/PM</b> <b>AOLV/PM</b> <b>CLV/PM</b> <b>EZOLV</b> Sets the speed range that detects overtorque and undertorque and the operation of drives (operation status) after detection. 0 : Disabled 1 : oL @ Speed Agree - Alarm only 2 : oL @ RUN - Alarm only 3 : oL @ Speed Agree - Fault 4 : oL @ RUN - Fault 5 : UL @ Speed Agree - Alarm only 6 : UL @ RUN - Alarm only 7 : UL @ Speed Agree - Fault 8 : UL @ RUN - Fault	0 (0 - 8)	971
L6-02 (04A2)	Torque Detection Level 1	<b>V/f</b> <b>CL-V/f</b> <b>OLV</b> <b>CLV</b> <b>AOLV</b> <b>OLV/PM</b> <b>AOLV/PM</b> <b>CLV/PM</b> <b>EZOLV</b> Sets the detection level for Overtorque/Undertorque Detection 1. In V/f control, drive rated output current = 100% value. In vector control, motor rated torque = 100% value.	150% (0 - 300%)	972
L6-03 (04A3)	Torque Detection Time 1	<b>V/f</b> <b>CL-V/f</b> <b>OLV</b> <b>CLV</b> <b>AOLV</b> <b>OLV/PM</b> <b>AOLV/PM</b> <b>CLV/PM</b> <b>EZOLV</b> Sets the detection time for Overtorque/Undertorque Detection 1.	0.1 s (0.0 - 10.0 s)	972

No. (Hex.)	Name	Description	Default (Range)	Ref.
L6-04 (04A4)	Torque Detection Selection 2	<p><b>V/f</b> <b>CL-V/f</b> <b>OLV</b> <b>CLV</b> <b>AOLV</b> <b>OLV/PM</b> <b>AOLV/PM</b> <b>CLV/PM</b> <b>EZOLV</b></p> <p>Sets the speed range that detects overtorque and undertorque and the operation of drives (operation status) after detection.</p> <p>0 : Disabled                      1 : oL @ Speed Agree - Alarm only                      2 : oL @ RUN - Alarm only                      3 : oL @ Speed Agree - Fault                      4 : oL @ RUN - Fault                      5 : UL @ Speed Agree - Alarm only                      6 : UL @ RUN - Alarm only                      7 : UL @ Speed Agree - Fault                      8 : UL @ RUN - Fault</p>	0 (0 - 8)	972
L6-05 (04A5)	Torque Detection Level 2	<p><b>V/f</b> <b>CL-V/f</b> <b>OLV</b> <b>CLV</b> <b>AOLV</b> <b>OLV/PM</b> <b>AOLV/PM</b> <b>CLV/PM</b> <b>EZOLV</b></p> <p>Sets the detection level for Overtorque/Undertorque Detection 2. In V/f control, drive rated output current = 100% value. In vector control, motor rated torque = 100% value.</p>	150% (0 - 300%)	973
L6-06 (04A6)	Torque Detection Time 2	<p><b>V/f</b> <b>CL-V/f</b> <b>OLV</b> <b>CLV</b> <b>AOLV</b> <b>OLV/PM</b> <b>AOLV/PM</b> <b>CLV/PM</b> <b>EZOLV</b></p> <p>Sets the detection time for Overtorque/Undertorque Detection 2.</p>	0.1 s (0.0 - 10.0 s)	973
L6-07 (04E5)	Torque Detection Filter Time	<p><b>V/f</b> <b>CL-V/f</b> <b>OLV</b> <b>CLV</b> <b>AOLV</b> <b>OLV/PM</b> <b>AOLV/PM</b> <b>CLV/PM</b> <b>EZOLV</b></p> <p>Sets the time constant for a primary filter to the torque reference or to the output current used to detect overtorque/undertorque.</p>	0 ms (0 - 1000 ms)	973
L6-08 (0468)	Mechanical Fatigue Detect Select	<p><b>V/f</b> <b>CL-V/f</b> <b>OLV</b> <b>CLV</b> <b>AOLV</b> <b>OLV/PM</b> <b>AOLV/PM</b> <b>CLV/PM</b> <b>EZOLV</b></p> <p>Sets the speed where the drive detects mechanical deterioration and how the drive operates (operation status) after detection.</p> <p>0 : Disabled                      1 : oL5 @ Speed &gt; L6-09 - Alarm                      2 : oL5 @ ISpeedl &gt; L6-09 - Alarm                      3 : oL5 @ Speed &gt; L6-09 - Fault                      4 : oL5 @ ISpeedl &gt; L6-09 - Fault                      5 : UL5 @ Speed &lt; L6-09 - Alarm                      6 : UL5 @ ISpeedl &lt; L6-09 - Alarm                      7 : UL5 @ Speed &lt; L6-09 - Fault                      8 : UL5 @ ISpeedl &lt; L6-09 - Fault</p>	0 (0 - 8)	973
L6-09 (0469)	Mech Fatigue Detect Speed Level	<p><b>V/f</b> <b>CL-V/f</b> <b>OLV</b> <b>CLV</b> <b>AOLV</b> <b>OLV/PM</b> <b>AOLV/PM</b> <b>CLV/PM</b> <b>EZOLV</b></p> <p>Sets the speed level as a percentage where the drive will operate the mechanical deterioration detection function, with E1-04 [Maximum Output Frequency] is the 100% value.</p>	110.0% (-110.0 - +110.0%)	974
L6-10 (046A)	Mech Fatigue Detect Delay Time	<p><b>V/f</b> <b>CL-V/f</b> <b>OLV</b> <b>CLV</b> <b>AOLV</b> <b>OLV/PM</b> <b>AOLV/PM</b> <b>CLV/PM</b> <b>EZOLV</b></p> <p>Sets the time for mechanical deterioration detection.</p>	0.1 s (0.0 - 10.0 s)	974
L6-11 (046B)	Mech Fatigue Hold Off Time	<p><b>V/f</b> <b>CL-V/f</b> <b>OLV</b> <b>CLV</b> <b>AOLV</b> <b>OLV/PM</b> <b>AOLV/PM</b> <b>CLV/PM</b> <b>EZOLV</b></p> <p>Sets the time that the drive will start mechanical deterioration detection triggered by the cumulative operation time of the drive.</p>	0 h (0 - 65535 h)	974

◆ L7: Torque Limit

No. (Hex.)	Name	Description	Default (Range)	Ref.
L7-01 (04A7) RUN	Forward Torque Limit	<p><b>V/f</b> <b>CL-V/f</b> <b>OLV</b> <b>CLV</b> <b>AOLV</b> <b>OLV/PM</b> <b>AOLV/PM</b> <b>CLV/PM</b> <b>EZOLV</b></p> <p>Sets the torque limit value for forward motoring as a percentage, where motor rated torque is the 100% value.</p>	200% (0 - 300%)	975
L7-02 (04A8) RUN	Reverse Torque Limit	<p><b>V/f</b> <b>CL-V/f</b> <b>OLV</b> <b>CLV</b> <b>AOLV</b> <b>OLV/PM</b> <b>AOLV/PM</b> <b>CLV/PM</b> <b>EZOLV</b></p> <p>Sets the torque limit value for reversed motoring as a percentage, where motor rated torque is the 100% value.</p>	200% (0 - 300%)	975
L7-03 (04A9) RUN	Forward Regenerative Trq Limit	<p><b>V/f</b> <b>CL-V/f</b> <b>OLV</b> <b>CLV</b> <b>AOLV</b> <b>OLV/PM</b> <b>AOLV/PM</b> <b>CLV/PM</b> <b>EZOLV</b></p> <p>Sets the torque limit value for forward regenerative conditions as a percentage of the motor rated torque.</p>	200% (0 - 300%)	976

No. (Hex.)	Name	Description	Default (Range)	Ref.
L7-04 (04AA) RUN	Reverse Regenerative Trq Limit	<input type="checkbox"/> V/f <input type="checkbox"/> CL-V/f <input checked="" type="checkbox"/> OLV <input type="checkbox"/> CLV <input type="checkbox"/> AOLV <input type="checkbox"/> OLV/PM <input type="checkbox"/> AOLV/PM <input type="checkbox"/> CLV/PM <input type="checkbox"/> EZOLV Sets the torque limit value for reversed regenerative conditions as a percentage of the motor rated torque.	200% (0 - 300%)	976
L7-06 (04AC)	Torque Limit Integral Time	<input type="checkbox"/> V/f <input type="checkbox"/> CL-V/f <input checked="" type="checkbox"/> OLV <input type="checkbox"/> CLV <input type="checkbox"/> AOLV <input type="checkbox"/> OLV/PM <input type="checkbox"/> AOLV/PM <input type="checkbox"/> CLV/PM <input type="checkbox"/> EZOLV Sets the integral time constant for the torque limit function.	200 ms (5 - 10000 ms)	976
L7-07 (04C9)	Torque Limit during Accel/Decel	<input type="checkbox"/> V/f <input type="checkbox"/> CL-V/f <input checked="" type="checkbox"/> OLV <input type="checkbox"/> CLV <input type="checkbox"/> AOLV <input type="checkbox"/> OLV/PM <input type="checkbox"/> AOLV/PM <input type="checkbox"/> CLV/PM <input type="checkbox"/> EZOLV Sets the torque limit function during acceleration and deceleration. 0 : Proportional only 1 : Proportional & Integral control	0 (0, 1)	976
L7-16 (044D)	Torque Limit Process at Start	<input type="checkbox"/> V/f <input type="checkbox"/> CL-V/f <input checked="" type="checkbox"/> OLV <input type="checkbox"/> CLV <input type="checkbox"/> AOLV <input type="checkbox"/> OLV/PM <input type="checkbox"/> AOLV/PM <input type="checkbox"/> CLV/PM <input type="checkbox"/> EZOLV Assigns a time filter to allow the torque limit to build at start. 0 : Disabled 1 : Enabled	1 (0, 1)	977
L7-35 (1B57) Expert	Low Freq Regen Torque Limit Lvl	<input type="checkbox"/> V/f <input type="checkbox"/> CL-V/f <input type="checkbox"/> OLV <input type="checkbox"/> CLV <input checked="" type="checkbox"/> AOLV <input type="checkbox"/> OLV/PM <input type="checkbox"/> AOLV/PM <input type="checkbox"/> CLV/PM <input type="checkbox"/> EZOLV Sets the torque limit used during low-speed regeneration. Usually it is not necessary to change this setting.	50.00% (0.00 - 200.00%)	977
L7-36 (1B58) Expert	Regen Torque Limit Derate Freq	<input type="checkbox"/> V/f <input type="checkbox"/> CL-V/f <input type="checkbox"/> OLV <input type="checkbox"/> CLV <input checked="" type="checkbox"/> AOLV <input type="checkbox"/> OLV/PM <input type="checkbox"/> AOLV/PM <input type="checkbox"/> CLV/PM <input type="checkbox"/> EZOLV Sets the frequency width at which L7-35 [Low Freq Regen Torque Limit Lvl] operates.	6.00 Hz (0.00 - 30.00 Hz)	977

## ◆ L8: Hardware Protection

No. (Hex.)	Name	Description	Default (Range)	Ref.
L8-01 (04AD)	3% ERF DB Resistor Protection	<input type="checkbox"/> V/f <input type="checkbox"/> CL-V/f <input checked="" type="checkbox"/> OLV <input type="checkbox"/> CLV <input type="checkbox"/> AOLV <input type="checkbox"/> OLV/PM <input type="checkbox"/> AOLV/PM <input type="checkbox"/> CLV/PM <input type="checkbox"/> EZOLV Sets the function to enable braking resistor protection with a Yaskawa ERF series braking resistor (3% ED) installed on the heatsink. 0 : Disabled 1 : Enabled	0 (0, 1)	978
L8-02 (04AE)	Overheat Alarm Level	<input type="checkbox"/> V/f <input type="checkbox"/> CL-V/f <input checked="" type="checkbox"/> OLV <input type="checkbox"/> CLV <input type="checkbox"/> AOLV <input type="checkbox"/> OLV/PM <input type="checkbox"/> AOLV/PM <input type="checkbox"/> CLV/PM <input type="checkbox"/> EZOLV Sets the <i>oH</i> detection level.	Determined by o2-04 and C6-01 (50 - 150 °C)	978
L8-03 (04AF)	Overheat Pre-Alarm Selection	<input type="checkbox"/> V/f <input type="checkbox"/> CL-V/f <input checked="" type="checkbox"/> OLV <input type="checkbox"/> CLV <input type="checkbox"/> AOLV <input type="checkbox"/> OLV/PM <input type="checkbox"/> AOLV/PM <input type="checkbox"/> CLV/PM <input type="checkbox"/> EZOLV Sets operation after the drive detects an <i>oH</i> alarm. 0 : Ramp to Stop 1 : Coast to Stop 2 : Fast Stop (Use C1-09) 3 : Alarm Only 4 : Operate at Reduced Speed (L8-19)	3 (0 - 4)	978
L8-05 (04B1)	Input Phase Loss Protection Sel	<input type="checkbox"/> V/f <input type="checkbox"/> CL-V/f <input checked="" type="checkbox"/> OLV <input type="checkbox"/> CLV <input type="checkbox"/> AOLV <input type="checkbox"/> OLV/PM <input type="checkbox"/> AOLV/PM <input type="checkbox"/> CLV/PM <input type="checkbox"/> EZOLV Sets the function to enable and disable input phase loss detection. 0 : Disabled 1 : Enabled	1 (0, 1)	979
L8-07 (04B3)	Output Phase Loss Protection Sel	<input type="checkbox"/> V/f <input type="checkbox"/> CL-V/f <input checked="" type="checkbox"/> OLV <input type="checkbox"/> CLV <input type="checkbox"/> AOLV <input type="checkbox"/> OLV/PM <input type="checkbox"/> AOLV/PM <input type="checkbox"/> CLV/PM <input type="checkbox"/> EZOLV Sets the function to enable and disable output phase loss detection. The drive starts output phase loss detection when the output current decreases to less than 5% of the drive rated current. <b>Note:</b> The drive can incorrectly start output phase loss detection in these conditions: • The motor rated current is very small compared to the drive rating. • The drive is operating a PM motor with a small load. 0 : Disabled 1 : Fault when one phase is lost 2 : Fault when two phases are lost	0 (0 - 2)	979

## 10.11 L: Protection Functions

No. (Hex.)	Name	Description	Default (Range)	Ref.
L8-09 (04B5)	Output Ground Fault Detection	<b>V/f</b> <b>CL-V/f</b> <b>OLV</b> <b>CLV</b> <b>AOLV</b> <b>OLV/PM</b> <b>AOLV/PM</b> <b>CLV/PM</b> <b>EZOLV</b> Sets the function to enable and disable ground fault protection. 0 : Disabled 1 : Enabled	Determined by o2-04 (0, 1)	980
L8-10 (04B6)	Heatsink Fan Operation Selection	<b>V/f</b> <b>CL-V/f</b> <b>OLV</b> <b>CLV</b> <b>AOLV</b> <b>OLV/PM</b> <b>AOLV/PM</b> <b>CLV/PM</b> <b>EZOLV</b> Sets operation of the heatsink cooling fan. 0 : During Run, w/ L8-11 Off-Delay 1 : Always On 2 : On when Drive Temp Reaches L8-64	0 (0 - 2)	980
L8-11 (04B7)	Heatsink Fan Off-Delay Time	<b>V/f</b> <b>CL-V/f</b> <b>OLV</b> <b>CLV</b> <b>AOLV</b> <b>OLV/PM</b> <b>AOLV/PM</b> <b>CLV/PM</b> <b>EZOLV</b> Sets the length of time that the drive will wait before stopping the cooling fan after cancelling the Run command when $L8-10 = 0$ [ <i>Heatsink Cooling Fan Ope Select = Dur Run (OffDly)</i> ].	60 s (0 - 300 s)	980
L8-12 (04B8)	Ambient Temperature Setting	<b>V/f</b> <b>CL-V/f</b> <b>OLV</b> <b>CLV</b> <b>AOLV</b> <b>OLV/PM</b> <b>AOLV/PM</b> <b>CLV/PM</b> <b>EZOLV</b> Sets the ambient temperature of the drive installation area.	40 °C (-10 - +50 °C)	980
L8-15 (04BB)	Drive oL2 @ Low Speed Protection	<b>V/f</b> <b>CL-V/f</b> <b>OLV</b> <b>CLV</b> <b>AOLV</b> <b>OLV/PM</b> <b>AOLV/PM</b> <b>CLV/PM</b> <b>EZOLV</b> Sets the function to decrease drive overload at low speeds to prevent damage to the main circuit transistor during low speed operation (at 6 Hz or slower) to prevent oL2 [ <i>Drive Overloaded</i> ]. <b>Note:</b> Contact Yaskawa or your nearest sales representative before disabling this function at low speeds. If you frequently operate drives with high output current in low speed ranges, it can cause heat stress and decrease the life span of drive IGBTs. 0 : Disabled (No Additional Derate) 1 : Enabled (Reduced oL2 Level)	1 (0, 1)	980
L8-18 (04BE)	Software Current Limit Selection	<b>V/f</b> <b>CL-V/f</b> <b>OLV</b> <b>CLV</b> <b>AOLV</b> <b>OLV/PM</b> <b>AOLV/PM</b> <b>CLV/PM</b> <b>EZOLV</b> Set the software current limit selection function to prevent damage to the main circuit transistor caused by too much current. 0 : Disabled 1 : Enabled	0 (0, 1)	981
L8-19 (04BF)	Freq Reduction @ oH Pre-Alarm	<b>V/f</b> <b>CL-V/f</b> <b>OLV</b> <b>CLV</b> <b>AOLV</b> <b>OLV/PM</b> <b>AOLV/PM</b> <b>CLV/PM</b> <b>EZOLV</b> Sets the ratio at which the drive derates the frequency reference when during an oH alarm.	0.8 (0.1 to 0.9)	981
L8-20 (04C0) Expert	Control Fault & Step Out Detect	<b>V/f</b> <b>CL-V/f</b> <b>OLV</b> <b>CLV</b> <b>AOLV</b> <b>OLV/PM</b> <b>AOLV/PM</b> <b>CLV/PM</b> <b>EZOLV</b> Sets operation after the drive detects a CF fault when $A1-02 = 4$ [ <i>Control Method Selection = Advanced Open Loop Vector</i> ]. 0 : Disabled 1 : CF/STPo Detection Enabled 2 : CF ALM/Stop	1 (0 - 2)	981
L8-27 (04DD)	Overcurrent Detection Gain	<b>V/f</b> <b>CL-V/f</b> <b>OLV</b> <b>CLV</b> <b>AOLV</b> <b>OLV/PM</b> <b>AOLV/PM</b> <b>CLV/PM</b> <b>EZOLV</b> Sets the PM motor overcurrent detection level as a percentage of the motor rated current value.	300.0% (0.0 - 400.0%)	982
L8-29 (04DF)	Output Unbalance Detection Sel	<b>V/f</b> <b>CL-V/f</b> <b>OLV</b> <b>CLV</b> <b>AOLV</b> <b>OLV/PM</b> <b>AOLV/PM</b> <b>CLV/PM</b> <b>EZOLV</b> Sets the function to detect LF2. 0 : Disabled 1 : Enabled	1 (0, 1)	982
L8-31 (04E1)	LF2 Detection Time	<b>V/f</b> <b>CL-V/f</b> <b>OLV</b> <b>CLV</b> <b>AOLV</b> <b>OLV/PM</b> <b>AOLV/PM</b> <b>CLV/PM</b> <b>EZOLV</b> Sets the LF2 [Output Current Imbalance] detection time.	3 (1 to 100)	982
L8-32 (04E2)	Cooling Fan Failure Selection	<b>V/f</b> <b>CL-V/f</b> <b>OLV</b> <b>CLV</b> <b>AOLV</b> <b>OLV/PM</b> <b>AOLV/PM</b> <b>CLV/PM</b> <b>EZOLV</b> Sets operation when the drive detects FAN [ <i>Internal Agitating Fan Fault</i> ]. 0 : Ramp to Stop 1 : Coast to Stop 2 : Fast Stop (Use C1-09) 3 : Alarm Only 4 : Operate at Reduced Speed (L8-19)	1 (0 - 4)	982



No. (Hex.)	Name	Description	Default (Range)	Ref.
L8-35 (04EC)	Installation Method Selection	<input type="checkbox"/> V/f <input type="checkbox"/> CL-V/f <input type="checkbox"/> OLV <input type="checkbox"/> CLV <input type="checkbox"/> AOLV <input type="checkbox"/> OLV/PM <input type="checkbox"/> AOLV/PM <input type="checkbox"/> CLV/PM <input type="checkbox"/> EZOLV Sets the type of drive installation. 0 : IP20/Open-Chassis enclosure 1 : Side-by-Side Mounting 2 : IP21/NEMA Type 1/IP55 3 : Finless / External Heatsink	Determined by the drive model (0 - 3)	983
L8-38 (04EF)	Carrier Frequency Reduction	<input type="checkbox"/> V/f <input type="checkbox"/> CL-V/f <input type="checkbox"/> OLV <input type="checkbox"/> CLV <input type="checkbox"/> AOLV <input type="checkbox"/> OLV/PM <input type="checkbox"/> AOLV/PM <input type="checkbox"/> CLV/PM <input type="checkbox"/> EZOLV Sets the carrier frequency reduction function. The drive reduces the carrier frequency when the output current is more than a specified level. 0 : Disabled 1 : Enabled below 6 Hz 2 : Enabled for All Speeds	Determined by A1-02, C6-01, and o2-04 (0 - 2)	983
L8-40 (04F1)	Carrier Freq Reduction Off-Delay	<input type="checkbox"/> V/f <input type="checkbox"/> CL-V/f <input type="checkbox"/> OLV <input type="checkbox"/> CLV <input type="checkbox"/> AOLV <input type="checkbox"/> OLV/PM <input type="checkbox"/> AOLV/PM <input type="checkbox"/> CLV/PM <input type="checkbox"/> EZOLV Sets the length of time until the automatically reduced carrier frequency returns to the condition before the reduction.	Determined by A1-02 (0.00 - 2.00 s)	984
L8-41 (04F2)	High Current Alarm Selection	<input type="checkbox"/> V/f <input type="checkbox"/> CL-V/f <input type="checkbox"/> OLV <input type="checkbox"/> CLV <input type="checkbox"/> AOLV <input type="checkbox"/> OLV/PM <input type="checkbox"/> AOLV/PM <input type="checkbox"/> CLV/PM <input type="checkbox"/> EZOLV Sets the function to cause an <i>HCA [Current Alarm]</i> when the output current is more than 150% of the drive rated current. 0 : Disabled 1 : Enabled	0 (0, 1)	984
L8-51 (0471) Expert	STPo I Detection Level	<input type="checkbox"/> V/f <input type="checkbox"/> CL-V/f <input type="checkbox"/> OLV <input type="checkbox"/> CLV <input type="checkbox"/> AOLV <input type="checkbox"/> OLV/PM <input type="checkbox"/> AOLV/PM <input type="checkbox"/> CLV/PM <input type="checkbox"/> EZOLV Sets the <i>STPo [Desynchronization Error]</i> detection level as a percentage of the output current.	0.0% (0.0 - 300.0%)	984
L8-52 (0472) Expert	STPo Integration Level	<input type="checkbox"/> V/f <input type="checkbox"/> CL-V/f <input type="checkbox"/> OLV <input type="checkbox"/> CLV <input type="checkbox"/> AOLV <input type="checkbox"/> OLV/PM <input type="checkbox"/> AOLV/PM <input type="checkbox"/> CLV/PM <input type="checkbox"/> EZOLV Sets the detection level for <i>STPo [Desynchronization Error]</i> related to the ACR integral value.	1.0 (0.1 - 2.0)	984
L8-53 (0473) Expert	STPo Integration Time	<input type="checkbox"/> V/f <input type="checkbox"/> CL-V/f <input type="checkbox"/> OLV <input type="checkbox"/> CLV <input type="checkbox"/> AOLV <input type="checkbox"/> OLV/PM <input type="checkbox"/> AOLV/PM <input type="checkbox"/> CLV/PM <input type="checkbox"/> EZOLV Sets the length of time until the drive detects <i>STPo</i> after exceeding the value of <i>L8-51 [STPo I Detection Level]</i> .	1.0 s (1.0 - 10.0 s)	985
L8-54 (0474) Expert	STPo Id Diff Detection	<input type="checkbox"/> V/f <input type="checkbox"/> CL-V/f <input type="checkbox"/> OLV <input type="checkbox"/> CLV <input type="checkbox"/> AOLV <input type="checkbox"/> OLV/PM <input type="checkbox"/> AOLV/PM <input type="checkbox"/> CLV/PM <input type="checkbox"/> EZOLV Sets the Id deviation detection function for <i>STPo [Desynchronization Error]</i> . 0 : Disabled 1 : Enabled	1 (0, 1)	985
L8-55 (045F)	Internal DB Transistor Protection	<input type="checkbox"/> V/f <input type="checkbox"/> CL-V/f <input type="checkbox"/> OLV <input type="checkbox"/> CLV <input type="checkbox"/> AOLV <input type="checkbox"/> OLV/PM <input type="checkbox"/> AOLV/PM <input type="checkbox"/> CLV/PM <input type="checkbox"/> EZOLV Sets the protection function for the internal braking transistor. 0 : Disable 1 : Protection Enabled	1 (0, 1)	985
L8-56 (047D) Expert	Stall P @ Accel Activation Time	<input type="checkbox"/> V/f <input type="checkbox"/> CL-V/f <input type="checkbox"/> OLV <input type="checkbox"/> CLV <input type="checkbox"/> AOLV <input type="checkbox"/> OLV/PM <input type="checkbox"/> AOLV/PM <input type="checkbox"/> CLV/PM <input type="checkbox"/> EZOLV Sets the length time that the acceleration stall prevention function can continue to operate before the drive detects an <i>STPo [Desynchronization Error]</i> .	5000 ms (100 - 5000 ms)	985
L8-57 (047E) Expert	Stall Prevention Retry Counts	<input type="checkbox"/> V/f <input type="checkbox"/> CL-V/f <input type="checkbox"/> OLV <input type="checkbox"/> CLV <input type="checkbox"/> AOLV <input type="checkbox"/> OLV/PM <input type="checkbox"/> AOLV/PM <input type="checkbox"/> CLV/PM <input type="checkbox"/> EZOLV Sets the number of times the acceleration stall prevention function can operate until speeds match before the drive detects an <i>STPo [Desynchronization Error]</i> .	10 times (1 - 10 times)	985
L8-90 (0175) Expert	STPo Detection Level (Low Speed)	<input type="checkbox"/> V/f <input type="checkbox"/> CL-V/f <input type="checkbox"/> OLV <input type="checkbox"/> CLV <input type="checkbox"/> AOLV <input type="checkbox"/> OLV/PM <input type="checkbox"/> AOLV/PM <input type="checkbox"/> CLV/PM <input type="checkbox"/> EZOLV Sets the detection level that the control fault must be equal to or more than to cause an <i>STPo [Desynchronization Error]</i> .	Determined by A1-02 (0 - 5000 times)	986
L8-93 (073C) Expert	Low Speed Pull-out Detection Time	<input type="checkbox"/> V/f <input type="checkbox"/> CL-V/f <input type="checkbox"/> OLV <input type="checkbox"/> CLV <input type="checkbox"/> AOLV <input type="checkbox"/> OLV/PM <input type="checkbox"/> AOLV/PM <input type="checkbox"/> CLV/PM <input type="checkbox"/> EZOLV Sets the length of time the drive will wait to start baseblock after detecting <i>LSo [LSo Fault]</i> .	1.0 s (0.0 - 10.0 s)	986

No. (Hex.)	Name	Description	Default (Range)	Ref.
L8-94 (073D) Expert	Low Speed Pull-out Detect Level	<div style="display: flex; justify-content: space-between; font-size: 0.8em; margin-bottom: 5px;"> <span>V/f</span> <span>CL-V/f</span> <span>OLV</span> <span>CLV</span> <span>AOLV</span> <span>OLV/PM</span> <span style="background-color: #cccccc;">AOLV/PM</span> <span>CLV/PM</span> <span>EZOLV</span> </div> Sets the detection level for <i>LSO</i> [Low Speed Motor Step-Out] as a percentage of <i>E1-04</i> [Maximum Output Frequency].	3% (0 - 10%)	986
L8-95 (077F) Expert	Low Speed Pull-out Amount	<div style="display: flex; justify-content: space-between; font-size: 0.8em; margin-bottom: 5px;"> <span>V/f</span> <span>CL-V/f</span> <span>OLV</span> <span>CLV</span> <span>AOLV</span> <span>OLV/PM</span> <span style="background-color: #cccccc;">AOLV/PM</span> <span>CLV/PM</span> <span>EZOLV</span> </div> Sets the average count of <i>LSO</i> [Low Speed Motor Step-Out] detections.	10 times (1 - 50 times)	986

◆ L9: Drive Protection 2

No. (Hex.)	Name	Description	Default (Range)	Ref.
L9-16 (11DC) Expert	FAn1 Detect Time	<div style="display: flex; justify-content: space-between; font-size: 0.8em; margin-bottom: 5px;"> <span style="background-color: #cccccc;">V/f</span> <span style="background-color: #cccccc;">CL-V/f</span> <span style="background-color: #cccccc;">OLV</span> <span style="background-color: #cccccc;">CLV</span> <span style="background-color: #cccccc;">AOLV</span> <span style="background-color: #cccccc;">OLV/PM</span> <span style="background-color: #cccccc;">AOLV/PM</span> <span style="background-color: #cccccc;">CLV/PM</span> <span style="background-color: #cccccc;">EZOLV</span> </div> Sets the detection time for <i>FAn1</i> [Drive Cooling Fan Failure]. Yaskawa recommends that you do not change this parameter value.	4.0 s (0.0 - 30.0 s)	986

## 10.12 n: Special Adjustment

### ◆ n1: Hunting Prevention

No. (Hex.)	Name	Description	Default (Range)	Ref.
n1-01 (0580)	Hunting Prevention Selection	<input checked="" type="checkbox"/> V/f <input checked="" type="checkbox"/> CL-V/f <input type="checkbox"/> OLV <input type="checkbox"/> CLV <input type="checkbox"/> AOLV <input type="checkbox"/> OLV/PM <input type="checkbox"/> AOLV/PM <input type="checkbox"/> CLV/PM <input type="checkbox"/> EZOLV Sets the function to prevent hunting. 0 : Disabled 1 : Enabled (Normal) 2 : Enabled (High Carrier Frequency)	Determined by o2-04 (0 - 2)	987
n1-02 (0581) Expert	Hunting Prevention Gain Setting	<input checked="" type="checkbox"/> V/f <input checked="" type="checkbox"/> CL-V/f <input type="checkbox"/> OLV <input type="checkbox"/> CLV <input type="checkbox"/> AOLV <input type="checkbox"/> OLV/PM <input type="checkbox"/> AOLV/PM <input type="checkbox"/> CLV/PM <input type="checkbox"/> EZOLV Adjusts the behavior of the hunting prevention function. Usually it is not necessary to change this setting.	1.00 (0.00 - 2.50)	987
n1-03 (0582) Expert	Hunting Prevention Time Constant	<input checked="" type="checkbox"/> V/f <input checked="" type="checkbox"/> CL-V/f <input type="checkbox"/> OLV <input type="checkbox"/> CLV <input type="checkbox"/> AOLV <input type="checkbox"/> OLV/PM <input type="checkbox"/> AOLV/PM <input type="checkbox"/> CLV/PM <input type="checkbox"/> EZOLV Sets the primary delay time constant of the hunting prevention function. Usually it is not necessary to change this setting.	Determined by o2-04 (0 - 500 ms)	987
n1-05 (0530) Expert	Hunting Prevent Gain in Reverse	<input checked="" type="checkbox"/> V/f <input checked="" type="checkbox"/> CL-V/f <input type="checkbox"/> OLV <input type="checkbox"/> CLV <input type="checkbox"/> AOLV <input type="checkbox"/> OLV/PM <input type="checkbox"/> AOLV/PM <input type="checkbox"/> CLV/PM <input type="checkbox"/> EZOLV Sets the performance of the hunting prevention function. This parameter adjusts Reverse run. Usually it is not necessary to change this setting.	0.00 (0.00 - 2.50)	988
n1-08 (1105) Expert	Current Detection Method	<input checked="" type="checkbox"/> V/f <input checked="" type="checkbox"/> CL-V/f <input checked="" type="checkbox"/> OLV <input checked="" type="checkbox"/> CLV <input type="checkbox"/> AOLV <input type="checkbox"/> OLV/PM <input type="checkbox"/> AOLV/PM <input type="checkbox"/> CLV/PM <input type="checkbox"/> EZOLV Sets how the drive decreases the motor vibration that is caused by leakage current. Usually it is not necessary to change this setting. 0 : 2-Phases 1 : 3-Phases	0 (0, 1)	988
n1-13 (1B59) Expert	DC Bus Stabilization Control	<input checked="" type="checkbox"/> V/f <input checked="" type="checkbox"/> CL-V/f <input type="checkbox"/> OLV <input type="checkbox"/> CLV <input type="checkbox"/> AOLV <input type="checkbox"/> OLV/PM <input type="checkbox"/> AOLV/PM <input type="checkbox"/> CLV/PM <input type="checkbox"/> EZOLV Sets the oscillation suppression function for the DC bus voltage. 0 : Disabled 1 : Enabled	0 (0, 1)	988
n1-14 (1B5A) Expert	DC Bus Stabilization Time	<input checked="" type="checkbox"/> V/f <input checked="" type="checkbox"/> CL-V/f <input type="checkbox"/> OLV <input type="checkbox"/> CLV <input type="checkbox"/> AOLV <input type="checkbox"/> OLV/PM <input type="checkbox"/> AOLV/PM <input type="checkbox"/> CLV/PM <input type="checkbox"/> EZOLV Sets a length of time for the drive to suppress oscillation in relation to the DC bus voltage. Set <i>n1-13 = 1 [DC Bus Stabilization Control = Enabled]</i> to enable this parameter.	100.0 ms (50.0 - 500.0 ms)	988
n1-15 (0BF8) Expert	PWM Voltage Offset Calibration	<input checked="" type="checkbox"/> V/f <input checked="" type="checkbox"/> CL-V/f <input checked="" type="checkbox"/> OLV <input checked="" type="checkbox"/> CLV <input type="checkbox"/> AOLV <input type="checkbox"/> OLV/PM <input type="checkbox"/> AOLV/PM <input type="checkbox"/> CLV/PM <input type="checkbox"/> EZOLV Sets the calibration method that the drive uses to decrease torque/current ripple. 0 : No Calibration 1 : One Time Calibrate at Next Start 2 : Calibrate Every Time at Start	Determined by A1-02 (0 - 2)	988
n1-16 (0BFB)	Hunting Prevention High Fc Gain	<input checked="" type="checkbox"/> V/f <input checked="" type="checkbox"/> CL-V/f <input type="checkbox"/> OLV <input type="checkbox"/> CLV <input type="checkbox"/> AOLV <input type="checkbox"/> OLV/PM <input type="checkbox"/> AOLV/PM <input type="checkbox"/> CLV/PM <input type="checkbox"/> EZOLV Sets the gain for the hunting prevention function. This parameter functions best with a high carrier frequency. Usually it is not necessary to change this setting.	Determined by o2-04 (0.00 - 2.50)	989
n1-17 (0BFC) Expert	Hunting Prevent High Fc Filter	<input checked="" type="checkbox"/> V/f <input checked="" type="checkbox"/> CL-V/f <input type="checkbox"/> OLV <input type="checkbox"/> CLV <input type="checkbox"/> AOLV <input type="checkbox"/> OLV/PM <input type="checkbox"/> AOLV/PM <input type="checkbox"/> CLV/PM <input type="checkbox"/> EZOLV Sets the responsiveness of the hunting prevention function. Usually it is not necessary to change this setting.	500 ms (0 - 1000 ms)	989

### ◆ n2: SpdFeedbackDetectControl(AFR)Tun

No. (Hex.)	Name	Description	Default (Range)	Ref.
n2-01 (0584)	Automatic Freq Regulator Gain	<input type="checkbox"/> V/f <input type="checkbox"/> CL-V/f <input checked="" type="checkbox"/> OLV <input type="checkbox"/> CLV <input type="checkbox"/> AOLV <input type="checkbox"/> OLV/PM <input type="checkbox"/> AOLV/PM <input type="checkbox"/> CLV/PM <input type="checkbox"/> EZOLV Sets the gain of the AFR function as a magnification value. Usually it is not necessary to change this setting.	1.00 (0.00 - 10.00)	989
n2-02 (0585)	Automatic Freq Regulator Time 1	<input type="checkbox"/> V/f <input type="checkbox"/> CL-V/f <input checked="" type="checkbox"/> OLV <input type="checkbox"/> CLV <input type="checkbox"/> AOLV <input type="checkbox"/> OLV/PM <input type="checkbox"/> AOLV/PM <input type="checkbox"/> CLV/PM <input type="checkbox"/> EZOLV Sets the time constant that sets the rate of change for the AFR function. Usually it is not necessary to change this setting.	50 ms (0 - 2000 ms)	989
n2-03 (0586)	Automatic Freq Regulator Time 2	<input type="checkbox"/> V/f <input type="checkbox"/> CL-V/f <input checked="" type="checkbox"/> OLV <input type="checkbox"/> CLV <input type="checkbox"/> AOLV <input type="checkbox"/> OLV/PM <input type="checkbox"/> AOLV/PM <input type="checkbox"/> CLV/PM <input type="checkbox"/> EZOLV Sets the time constant that sets the speed difference of the AFR function. Use this parameter for speed searches or regeneration. Usually it is not necessary to change this setting.	750 ms (0 - 2000 ms)	990

### ◆ n3: High Slip Braking (HSB)

No. (Hex.)	Name	Description	Default (Range)	Ref.
n3-01 (0588) Expert	HSB Deceleration Frequency Width	<input type="checkbox"/> V/f <input type="checkbox"/> CL-V/f <input type="checkbox"/> OLV <input type="checkbox"/> CLV <input type="checkbox"/> AOLV <input type="checkbox"/> OLV/PM <input type="checkbox"/> AOLV/PM <input type="checkbox"/> CLV/PM <input type="checkbox"/> EZOLV Sets how much the drive lowers the output frequency during high-slip braking as a percentage where <i>E1-04 [Maximum Output Frequency]</i> = 100%.	5% (1 - 20%)	992
n3-02 (0589) Expert	HSB Current Limit Level	<input type="checkbox"/> V/f <input type="checkbox"/> CL-V/f <input type="checkbox"/> OLV <input type="checkbox"/> CLV <input type="checkbox"/> AOLV <input type="checkbox"/> OLV/PM <input type="checkbox"/> AOLV/PM <input type="checkbox"/> CLV/PM <input type="checkbox"/> EZOLV Sets the maximum current output during high-slip braking as a percentage where <i>E2-01 [Motor Rated Current (FLA)]</i> = 100%. Also set the current suppression to prevent exceeding drive overload tolerance.	Determined by C6-01, L8-38 (0 - 200%)	992
n3-03 (058A) Expert	HSB Dwell Time at Stop	<input type="checkbox"/> V/f <input type="checkbox"/> CL-V/f <input type="checkbox"/> OLV <input type="checkbox"/> CLV <input type="checkbox"/> AOLV <input type="checkbox"/> OLV/PM <input type="checkbox"/> AOLV/PM <input type="checkbox"/> CLV/PM <input type="checkbox"/> EZOLV Sets the dwell time, a length of time when high-slip braking is ending and during which the motor speed decreases and runs at a stable speed. For a set length of time, the drive will hold the actual output frequency at the minimum output frequency set in <i>E1-09</i> .	1.0 s (0.0 - 10.0 s)	992
n3-04 (058B) Expert	HSB Overload Time	<input type="checkbox"/> V/f <input type="checkbox"/> CL-V/f <input type="checkbox"/> OLV <input type="checkbox"/> CLV <input type="checkbox"/> AOLV <input type="checkbox"/> OLV/PM <input type="checkbox"/> AOLV/PM <input type="checkbox"/> CLV/PM <input type="checkbox"/> EZOLV Sets the time used to detect <i>oL7 [High Slip Braking Overload]</i> , which occurs when the output frequency does not change during high-slip braking. Usually it is not necessary to change this setting.	40 s (30 - 1200 s)	992
n3-13 (0531)	OverexcitationBraking (OEB) Gain	<input type="checkbox"/> V/f <input type="checkbox"/> CL-V/f <input type="checkbox"/> OLV <input type="checkbox"/> CLV <input type="checkbox"/> AOLV <input type="checkbox"/> OLV/PM <input type="checkbox"/> AOLV/PM <input type="checkbox"/> CLV/PM <input type="checkbox"/> EZOLV Sets the gain value that the drive multiplies by the V/f pattern output value during overexcitation deceleration to calculate the overexcitation level.	1.10 (1.00 - 1.40)	992
n3-14 (0532) Expert	OEB High Frequency Injection	<input type="checkbox"/> V/f <input type="checkbox"/> CL-V/f <input type="checkbox"/> OLV <input type="checkbox"/> CLV <input type="checkbox"/> AOLV <input type="checkbox"/> OLV/PM <input type="checkbox"/> AOLV/PM <input type="checkbox"/> CLV/PM <input type="checkbox"/> EZOLV Sets the function that injects harmonic signals during overexcitation deceleration. 0 : Disabled 1 : Enabled	0 (0, 1)	993
n3-21 (0579)	HSB Current Suppression Level	<input type="checkbox"/> V/f <input type="checkbox"/> CL-V/f <input type="checkbox"/> OLV <input type="checkbox"/> CLV <input type="checkbox"/> AOLV <input type="checkbox"/> OLV/PM <input type="checkbox"/> AOLV/PM <input type="checkbox"/> CLV/PM <input type="checkbox"/> EZOLV Sets the upper limit of the current that is suppressed at the time of overexcitation deceleration, where the drive rated current = 100% value.	100% (0 - 150%)	993
n3-23 (057B)	Overexcitation Braking Operation	<input type="checkbox"/> V/f <input type="checkbox"/> CL-V/f <input type="checkbox"/> OLV <input type="checkbox"/> CLV <input type="checkbox"/> AOLV <input type="checkbox"/> OLV/PM <input type="checkbox"/> AOLV/PM <input type="checkbox"/> CLV/PM <input type="checkbox"/> EZOLV Sets the direction of motor rotation where the drive will enable overexcitation. 0 : Disabled 1 : Enabled Only when Rotating FWD 2 : Enabled Only when Rotating REV	0 (0 - 2)	993

## ◆ n4: Observer

No. (Hex.)	Name	Description	Default (Range)	Ref.
n4-60 (1B80)	Motoring Low Speed Comp Gain	<input type="checkbox"/> V/f <input type="checkbox"/> CL-V/f <input type="checkbox"/> OLV <input type="checkbox"/> CLV <input checked="" type="checkbox"/> AOLV <input type="checkbox"/> OLV/PM <input type="checkbox"/> AOLV/PM <input type="checkbox"/> CLV/PM <input type="checkbox"/> EZOLV Sets a compensation gain to improve the control qualities for motoring loads in the low speed range.	100.0% (50.0 - 200.0%)	994
n4-61 (1B81)	Low Speed Comp Frequency Level	<input type="checkbox"/> V/f <input type="checkbox"/> CL-V/f <input type="checkbox"/> OLV <input type="checkbox"/> CLV <input checked="" type="checkbox"/> AOLV <input type="checkbox"/> OLV/PM <input type="checkbox"/> AOLV/PM <input type="checkbox"/> CLV/PM <input type="checkbox"/> EZOLV Sets a frequency at which the settings for n4-60 [Motoring Low Speed Comp Gain], n4-62 [Regen Low Speed Comp Gain] are enabled. When the output frequency < n4-61, the drive adjusts the torque to agree with the settings for n4-60 and n4-62. Usually it is not necessary to change this setting.	6.00 Hz (0.50 - 12.00 Hz)	994
n4-62 (1B82)	Regen Low Speed Comp Gain	<input type="checkbox"/> V/f <input type="checkbox"/> CL-V/f <input type="checkbox"/> OLV <input type="checkbox"/> CLV <input checked="" type="checkbox"/> AOLV <input type="checkbox"/> OLV/PM <input type="checkbox"/> AOLV/PM <input type="checkbox"/> CLV/PM <input type="checkbox"/> EZOLV Sets a compensation gain to improve the control qualities for regenerative loads in the low speed range.	100.0% (50.0 - 200.0%)	994
n4-63 (1B83)	Speed Estimate Response@High Freq	<input type="checkbox"/> V/f <input type="checkbox"/> CL-V/f <input type="checkbox"/> OLV <input type="checkbox"/> CLV <input checked="" type="checkbox"/> AOLV <input type="checkbox"/> OLV/PM <input type="checkbox"/> AOLV/PM <input type="checkbox"/> CLV/PM <input type="checkbox"/> EZOLV Sets the responsiveness of the speed estimation in high speed ranges, where the output frequency is ≥ n4-67 [Estimate Gain Switchover Freq].	60.0 (0.1 - 150.0)	994
n4-64 (1B84)	Speed Estimate Response@Low Freq	<input type="checkbox"/> V/f <input type="checkbox"/> CL-V/f <input type="checkbox"/> OLV <input type="checkbox"/> CLV <input checked="" type="checkbox"/> AOLV <input type="checkbox"/> OLV/PM <input type="checkbox"/> AOLV/PM <input type="checkbox"/> CLV/PM <input type="checkbox"/> EZOLV Sets the responsiveness of the speed estimation in low speed ranges, where 0 ≤ the output frequency, which is < n4-67 [Estimate Gain Switchover Freq].	60.0 (0.1 - 150.0)	995
n4-65 (1B85)	Flux Estimate Response@High Freq	<input type="checkbox"/> V/f <input type="checkbox"/> CL-V/f <input type="checkbox"/> OLV <input checked="" type="checkbox"/> CLV <input checked="" type="checkbox"/> AOLV <input type="checkbox"/> OLV/PM <input type="checkbox"/> AOLV/PM <input type="checkbox"/> CLV/PM <input type="checkbox"/> EZOLV Sets the responsiveness of the magnetic flux estimation in high speed ranges, where the output frequency is ≥ n4-67 [Estimate Gain Switchover Freq]. Usually it is not necessary to change this setting.	0.90 (0.50 - 1.50)	995
n4-66 (1B86)	Flux Estimate Response @Low Freq	<input type="checkbox"/> V/f <input type="checkbox"/> CL-V/f <input type="checkbox"/> OLV <input checked="" type="checkbox"/> CLV <input checked="" type="checkbox"/> AOLV <input type="checkbox"/> OLV/PM <input type="checkbox"/> AOLV/PM <input type="checkbox"/> CLV/PM <input type="checkbox"/> EZOLV Sets the responsiveness of the magnetic flux estimation in low speed ranges, where 0 ≤ the output frequency, which is < n4-67 [Estimate Gain Switchover Freq]. Usually it is not necessary to change this setting.	0.90 (0.50 - 1.50)	995
n4-67 (1B87)	Estimate Gain Switchover Freq	<input type="checkbox"/> V/f <input type="checkbox"/> CL-V/f <input type="checkbox"/> OLV <input checked="" type="checkbox"/> CLV <input checked="" type="checkbox"/> AOLV <input type="checkbox"/> OLV/PM <input type="checkbox"/> AOLV/PM <input type="checkbox"/> CLV/PM <input type="checkbox"/> EZOLV Sets the switching frequency for estimation gain for these parameters: n4-63 [Speed Estimate Response@High Freq] n4-64 [Speed Estimate Response@Low Freq] n4-65 [Flux Estimate Response@High Freq] n4-66 [Flux Estimate Response @Low Freq] Usually it is not necessary to change this setting.	6.00 Hz (0.00 - E1-04)	995
n4-68 (1B88)	Speed Estimation Filter Time	<input type="checkbox"/> V/f <input type="checkbox"/> CL-V/f <input type="checkbox"/> OLV <input type="checkbox"/> CLV <input checked="" type="checkbox"/> AOLV <input type="checkbox"/> OLV/PM <input type="checkbox"/> AOLV/PM <input type="checkbox"/> CLV/PM <input type="checkbox"/> EZOLV Sets the primary delay time constant for the speed estimation value. Usually it is not necessary to change this setting.	0.001 s (0.001 - 0.010 s)	995
n4-69 (1B89)	Flux Control Response	<input type="checkbox"/> V/f <input type="checkbox"/> CL-V/f <input type="checkbox"/> OLV <input type="checkbox"/> CLV <input checked="" type="checkbox"/> AOLV <input type="checkbox"/> OLV/PM <input type="checkbox"/> AOLV/PM <input type="checkbox"/> CLV/PM <input type="checkbox"/> EZOLV Unifies control of magnetic flux to make motor vibrations more stable.	1.00 (0.00 - 60.00)	996
n4-70 (1B8A)	Speed Command Comp @ Low Freq	<input type="checkbox"/> V/f <input type="checkbox"/> CL-V/f <input type="checkbox"/> OLV <input type="checkbox"/> CLV <input checked="" type="checkbox"/> AOLV <input type="checkbox"/> OLV/PM <input type="checkbox"/> AOLV/PM <input type="checkbox"/> CLV/PM <input type="checkbox"/> EZOLV Sets the function to make the drive more stable when operating at low speeds. Usually it is not necessary to change this setting.	0.60 Hz (0.00 - 1.50 Hz)	996
n4-72 (1B8C)	Speed Feedback Mode	<input type="checkbox"/> V/f <input type="checkbox"/> CL-V/f <input type="checkbox"/> OLV <input type="checkbox"/> CLV <input checked="" type="checkbox"/> AOLV <input type="checkbox"/> OLV/PM <input type="checkbox"/> AOLV/PM <input type="checkbox"/> CLV/PM <input type="checkbox"/> EZOLV Sets the requirement for an encoder option when A1-02 = 4 [Control Method Selection = Advanced Open Loop Vector]. 0 : Without Encoder 1 : With Encoder	0 (0, 1)	996
n4-73 (1B8D)	PGo Recovery Selection	<input type="checkbox"/> V/f <input type="checkbox"/> CL-V/f <input type="checkbox"/> OLV <input type="checkbox"/> CLV <input checked="" type="checkbox"/> AOLV <input type="checkbox"/> OLV/PM <input type="checkbox"/> AOLV/PM <input type="checkbox"/> CLV/PM <input type="checkbox"/> EZOLV Sets the restart mode to Without Encoder Mode or the With Encoder Mode when an encoder is disconnected. 0 : Without Encoder 1 : With Encoder	0 (0, 1)	996
n4-74 (1B8E)	Limit of Flux Loop	<input type="checkbox"/> V/f <input type="checkbox"/> CL-V/f <input type="checkbox"/> OLV <input type="checkbox"/> CLV <input checked="" type="checkbox"/> AOLV <input type="checkbox"/> OLV/PM <input type="checkbox"/> AOLV/PM <input type="checkbox"/> CLV/PM <input type="checkbox"/> EZOLV Sets the control level for flux loop control output.	160% (100 - 500%)	997

## ◆ n5: Feed Forward Control

No. (Hex.)	Name	Description	Default (Range)	Ref.
n5-01 (05B0)	Feed Forward Control Selection	<div style="display: flex; justify-content: space-between; gap: 5px;"> <span>V/f</span> <span>CL-V/f</span> <span>OLV</span> <span><b>CLV</b></span> <span>AOLV</span> <span>OLV/PM</span> <span>AOLV/PM</span> <span>CLV/PM</span> <span>EZOLV</span> </div> Sets the feed forward function. 0 : Disabled 1 : Enabled	0 (0, 1)	998
n5-02 (05B1)	Motor Inertia Acceleration Time	<div style="display: flex; justify-content: space-between; gap: 5px;"> <span>V/f</span> <span>CL-V/f</span> <span>OLV</span> <span><b>CLV</b></span> <span>AOLV</span> <span>OLV/PM</span> <span>AOLV/PM</span> <span>CLV/PM</span> <span>EZOLV</span> </div> Sets the length of time for the motor to accelerate from the stopped to the maximum frequency with a single motor at the rated torque. Inertia Tuning automatically sets the motor acceleration time.	Determined by C6-01, E5-01, and o2-04 (0.001 - 10.000 s)	998
n5-03 (05B2)	Feed Forward Control Gain	<div style="display: flex; justify-content: space-between; gap: 5px;"> <span>V/f</span> <span>CL-V/f</span> <span>OLV</span> <span><b>CLV</b></span> <span>AOLV</span> <span>OLV/PM</span> <span>AOLV/PM</span> <span>CLV/PM</span> <span>EZOLV</span> </div> Sets the ratio between load inertia and motor inertia. Inertia Tuning automatically sets the Feedforward Control Gain value.	1.00 (0.00 - 100.00)	999
n5-04 (05B3) RUN Expert	Speed Response Frequency	<div style="display: flex; justify-content: space-between; gap: 5px;"> <span>V/f</span> <span>CL-V/f</span> <span>OLV</span> <span><b>CLV</b></span> <span>AOLV</span> <span>OLV/PM</span> <span>AOLV/PM</span> <span>CLV/PM</span> <span>EZOLV</span> </div> Sets the response frequency for the speed reference. Usually it is not necessary to change this setting.	Determined by A1-02 (0.00 - 500.00 Hz)	999

## ◆ n6: Online Tuning

No. (Hex.)	Name	Description	Default (Range)	Ref.
n6-01 (0570)	Online Tuning Selection	<div style="display: flex; justify-content: space-between; gap: 5px;"> <span>V/f</span> <span>CL-V/f</span> <span><b>OLV</b></span> <span>CLV</span> <span>AOLV</span> <span>OLV/PM</span> <span>AOLV/PM</span> <span>CLV/PM</span> <span>EZOLV</span> </div> Sets the type of motor data that Online Tuning uses for OLV control. 0 : Disabled 1 : Line-to-Line Resistance Tuning 2 : Voltage Correction Tuning	0 (0 - 2)	1000
n6-05 (05C7) Expert	Online Tuning Gain	<div style="display: flex; justify-content: space-between; gap: 5px;"> <span>V/f</span> <span>CL-V/f</span> <span><b>OLV</b></span> <span>CLV</span> <span>AOLV</span> <span>OLV/PM</span> <span>AOLV/PM</span> <span>CLV/PM</span> <span>EZOLV</span> </div> Sets the compensation gain when $n6-01 = 2$ [Online Tuning Selection = Voltage Correction Tuning]. Usually it is not necessary to change this setting.	1.0 (0.1 - 50.0)	1000
n6-11 (1B56) Expert	Online Resistance Tuning	<div style="display: flex; justify-content: space-between; gap: 5px;"> <span>V/f</span> <span>CL-V/f</span> <span>OLV</span> <span><b>CLV</b></span> <span>AOLV</span> <span>OLV/PM</span> <span>AOLV/PM</span> <span>CLV/PM</span> <span>EZOLV</span> </div> Sets the responsiveness for online resistor tuning. Set this parameter to approximately 1.000 to enable the function. The function is disabled when the value is 0.000.	0.000 (0.000 - 1.000)	1000

## ◆ n7: EZ Drive

No. (Hex.)	Name	Description	Default (Range)	Ref.
n7-01 (3111) Expert	Damping Gain for Low Frequency	<div style="display: flex; justify-content: space-between; gap: 5px;"> <span>V/f</span> <span>CL-V/f</span> <span>OLV</span> <span>CLV</span> <span>AOLV</span> <span>OLV/PM</span> <span>AOLV/PM</span> <span>CLV/PM</span> <span><b>EZOLV</b></span> </div> Sets the oscillation suppression gain for the low speed range.	1.0 (0.1 - 10.0)	1000
n7-05 (3115) Expert	Response Gain for Load Changes	<div style="display: flex; justify-content: space-between; gap: 5px;"> <span>V/f</span> <span>CL-V/f</span> <span>OLV</span> <span>CLV</span> <span>AOLV</span> <span>OLV/PM</span> <span>AOLV/PM</span> <span>CLV/PM</span> <span><b>EZOLV</b></span> </div> Sets the response gain related to changes in the load.	100 (10 - 1000)	1000
n7-07 (3117) Expert	Speed Calculation Gain1	<div style="display: flex; justify-content: space-between; gap: 5px;"> <span>V/f</span> <span>CL-V/f</span> <span>OLV</span> <span>CLV</span> <span>AOLV</span> <span>OLV/PM</span> <span>AOLV/PM</span> <span>CLV/PM</span> <span><b>EZOLV</b></span> </div> Sets the speed calculation gain during usual operation. Usually it is not necessary to change this setting.	15.0 Hz (1.0 - 50.0 Hz)	1001
n7-08 (3118) Expert	Speed Calculation Gain2	<div style="display: flex; justify-content: space-between; gap: 5px;"> <span>V/f</span> <span>CL-V/f</span> <span>OLV</span> <span>CLV</span> <span>AOLV</span> <span>OLV/PM</span> <span>AOLV/PM</span> <span>CLV/PM</span> <span><b>EZOLV</b></span> </div> Sets the speed calculation gain during a speed search.	25.0 Hz (1.0 - 50.0 Hz)	1001

No. (Hex.)	Name	Description	Default (Range)	Ref.
n7-10 (311A) Expert	Pull-in Current Switching Speed	V/f CL-V/f OLV CLV AOLV OLV/PM AOLV/PM CLV/PM EZOLV Sets a speed range proportional to the rated frequency that enables pull-in current commands.	10.0% (0.0 - 100.0%)	1001
n7-17 (3122)	Resistance Temperature Correction	V/f CL-V/f OLV CLV AOLV OLV/PM AOLV/PM CLV/PM EZOLV Sets the function to adjust for changes in the motor resistance value caused by changes in the temperature. 0 : Invalid 1 : Valid (Only 1 time) 2 : Valid (Every time)	1 (0 - 2)	1001

## ◆ n8: PM Motor Control Tuning

No. (Hex.)	Name	Description	Default (Range)	Ref.
n8-01 (0540) Expert	Pole Position Detection Current	V/f CL-V/f OLV CLV AOLV OLV/PM AOLV/PM CLV/PM EZOLV Sets the Initial Rotor Position Estimated Current as a percentage where $E5-03 [PM \text{ Motor Rated Current } (FLA)] = 100\%$ . Usually it is not necessary to change this setting.	50% (0 - 100%)	1002
n8-02 (0541) Expert	Pole Alignment Current Level	V/f CL-V/f OLV CLV AOLV OLV/PM AOLV/PM CLV/PM EZOLV Sets the current at the time of polar attraction as a percentage where motor rated current = 100%. Usually it is not necessary to change this setting.	80% (0 - 150%)	1002
n8-03 (0542)	Pole Position Detection Time	V/f CL-V/f OLV CLV AOLV OLV/PM AOLV/PM CLV/PM EZOLV Sets the length of the Current Starting Time, which is used for Z Pulse Offset Tuning. Usually it is not necessary to change this parameter.	1.5 s (1.5 - 5.0 s)	1002
n8-04 (0543) Expert	Pole Alignment Time	V/f CL-V/f OLV CLV AOLV OLV/PM AOLV/PM CLV/PM EZOLV Sets the length of the Polar Attraction Time, which is used for Z Pulse Offset Tuning. Usually it is not necessary to change this setting.	1.5 s (1.5 - 5.0 s)	1002
n8-11 (054A)	Observer Calculation Gain 2	V/f CL-V/f OLV CLV AOLV OLV/PM AOLV/PM CLV/PM EZOLV Sets the gain for speed estimation. Usually it is not necessary to change this setting.	Determined by n8-72 (0.0 - 1000.0)	1002
n8-14 (054D) Expert	Polarity Compensation Gain 3	V/f CL-V/f OLV CLV AOLV OLV/PM AOLV/PM CLV/PM EZOLV Sets the gain for speed estimation. Usually it is not necessary to change this setting.	1.000 (0.000 - 10.000)	1003
n8-15 (054E) Expert	Polarity Compensation Gain 4	V/f CL-V/f OLV CLV AOLV OLV/PM AOLV/PM CLV/PM EZOLV Sets the gain for speed estimation. Usually it is not necessary to change this setting.	0.500 (0.000 - 10.000)	1003
n8-21 (0554) Expert	Motor Back-EMF (Ke) Gain	V/f CL-V/f OLV CLV AOLV OLV/PM AOLV/PM CLV/PM EZOLV Sets the gain for speed estimation. Usually it is not necessary to change this setting.	0.90 (0.80 - 1.00)	1003
n8-35 (0562)	Initial Pole Detection Method	V/f CL-V/f OLV CLV AOLV OLV/PM AOLV/PM CLV/PM EZOLV Sets how the drive detects the position of the rotor at start. <b>Note:</b> When you use an SPM motor, set this parameter to 0. 0 : Pull-in 1 : High Frequency Injection 2 : Pulse Injection	Determined by A1-02 (0 - 2)	1003
n8-36 (0563)	HFI Frequency Level for L Tuning	V/f CL-V/f OLV CLV AOLV OLV/PM AOLV/PM CLV/PM EZOLV Sets the injection frequency for high frequency injection.	500 Hz (200 - 5000 Hz)	1003
n8-37 (0564) Expert	HFI Voltage Amplitude Level	V/f CL-V/f OLV CLV AOLV OLV/PM AOLV/PM CLV/PM EZOLV Sets the high frequency injection amplitude as a percentage where $200 \text{ V} = 100\%$ for 200 V class drives and $400 \text{ V} = 100\%$ for a 400 V class drives. Usually it is not necessary to change this setting.	20.0% (0.0 - 50.0%)	1004

No. (Hex.)	Name	Description	Default (Range)	Ref.
n8-41 (0568) Expert	HFI P Gain	V/f CL-V/f OLV CLV AOLV <b>OLV/PM</b> AOLV/PM CLV/PM EZOLV Sets the speed estimation response for high frequency injection. Usually it is not necessary to change this setting.	3.0 (1.0 - 100.0)	1004
n8-42 (0569) Expert	HFI I Time	V/f CL-V/f OLV CLV AOLV <b>OLV/PM</b> AOLV/PM CLV/PM EZOLV Sets the oscillation suppression gain of the speed estimation for high frequency injection. Usually it is not necessary to change this setting.	1.0 (0.1 - 5.0)	1004
n8-45 (0538)	Speed Feedback Detection Gain	V/f CL-V/f OLV CLV AOLV <b>OLV/PM</b> AOLV/PM CLV/PM EZOLV Sets the internal speed feedback detection reduction unit gain as a magnification value. Usually it is not necessary to change this parameter.	0.80 (0.00 - 10.00)	1004
n8-47 (053A)	Pull-in Current Comp Filter Time	V/f CL-V/f OLV CLV AOLV <b>OLV/PM</b> AOLV/PM CLV/PM EZOLV Sets the time constant the drive uses to align the pull-in current reference value with the actual current value. Usually it is not necessary to change this parameter.	5.0 s (0.0 - 100.0 s)	1004
n8-48 (053B)	Pull-in/Light Load Id Current	V/f CL-V/f OLV CLV AOLV <b>OLV/PM</b> AOLV/PM CLV/PM EZOLV Sets the d-axis current that flows to the motor during run at constant speed as a percentage where $E5-03 [PM \text{ Motor Rated Current } (FLA)] = 100\%$ .	30% (20 - 200%)	1005
n8-49 (053C) Expert	Heavy Load Id Current	V/f CL-V/f OLV CLV AOLV <b>OLV/PM</b> AOLV/PM CLV/PM EZOLV Sets the d-axis current to that the drive will supply to the motor to run it at a constant speed with a heavy load. This parameter is a percentage where $E5-03 [PM \text{ Motor Rated Current } (FLA)] = 100\%$ . Usually it is not necessary to change this setting.	Determined by E5-01 (-200.0 - 0.0%)	1005
n8-51 (053E)	Pull-in Current @ Acceleration	V/f CL-V/f OLV CLV AOLV <b>OLV/PM</b> AOLV/PM CLV/PM EZOLV Sets the pull-in current that can flow during acceleration/ deceleration as a percentage where $E5-03 [PM \text{ Motor Rated Current } (FLA)] = 100\%$ .	Determined by A1-02 (0 - 200%)	1005
n8-54 (056D) Expert	Voltage Error Compensation Time	V/f CL-V/f OLV CLV AOLV <b>OLV/PM</b> AOLV/PM CLV/PM EZOLV Sets the time constant that the drive uses when adjusting for voltage errors.	1.00 s (0.00 - 10.00 s)	1005
n8-55 (056E)	Motor to Load Inertia Ratio	V/f CL-V/f OLV CLV AOLV <b>OLV/PM</b> AOLV/PM CLV/PM EZOLV Sets the ratio between motor inertia and machine inertia. 0 : Below 1:10 1 : Between 1:10 and 1:30 2 : Between 1:30 and 1:50 3 : Beyond 1:50	0 (0 - 3)	1006
n8-57 (0574)	HFI Overlap Selection	V/f CL-V/f OLV CLV AOLV <b>OLV/PM</b> AOLV/PM CLV/PM EZOLV Sets the function that detects motor speed with high frequency injection. 0 : Disabled 1 : Enabled	0 (0, 1)	1006
n8-62 (057D) Expert	Output Voltage Limit Level	V/f CL-V/f OLV CLV AOLV <b>OLV/PM</b> AOLV/PM CLV/PM EZOLV Sets the output voltage limit to prevent saturation of the output voltage. Usually it is not necessary to change this setting.	200 V Class: 200.0 V, 400 V Class: 400.0 V (200 V Class: 0.0 - 230.0 V, 400 V Class: 0.0 - 460.0 V)	1007
n8-65 (065C) Expert	Speed Fdbk Gain @ oV Suppression	V/f CL-V/f OLV CLV AOLV <b>OLV/PM</b> AOLV/PM CLV/PM EZOLV Sets the gain of internal speed feedback detection suppression while the overvoltage suppression function is operating as a magnification value. Usually it is not necessary to change this parameter.	1.50 (0.00 - 10.00)	1007
n8-69 (065D) Expert	Speed Observer Control P Gain	V/f CL-V/f OLV CLV AOLV <b>OLV/PM</b> AOLV/PM CLV/PM EZOLV Sets the gain that the drive uses for speed estimation. Usually it is not necessary to change this setting.	1.00 (0.00 - 20.00)	1007



No. (Hex.)	Name	Description	Default (Range)	Ref.
n8-72 (0655) Expert	Speed Estimation Method Select	<input type="checkbox"/> V/f <input type="checkbox"/> CL-V/f <input type="checkbox"/> OLV <input type="checkbox"/> CLV <input type="checkbox"/> AOLV <input type="checkbox"/> OLV/PM <input checked="" type="checkbox"/> AOLV/PM <input type="checkbox"/> CLV/PM <input type="checkbox"/> EZOLV Selects the speed estimation method. Usually it is not necessary to change this setting. 0 : Method 1 1 : Method 2	1 (0, 1)	1007
n8-74 (05C3) Expert	Light Load Iq Level	<input type="checkbox"/> V/f <input type="checkbox"/> CL-V/f <input type="checkbox"/> OLV <input type="checkbox"/> CLV <input type="checkbox"/> AOLV <input checked="" type="checkbox"/> OLV/PM <input type="checkbox"/> AOLV/PM <input type="checkbox"/> CLV/PM <input type="checkbox"/> EZOLV Set n8-48 [Pull-in/Light Load Id Current] to the level of the load current (q-axis current) to be applied.	30% (0 - 255%)	1007
n8-75 (05C4) Expert	Medium Load Iq Level (low)	<input type="checkbox"/> V/f <input type="checkbox"/> CL-V/f <input type="checkbox"/> OLV <input type="checkbox"/> CLV <input type="checkbox"/> AOLV <input checked="" type="checkbox"/> OLV/PM <input type="checkbox"/> AOLV/PM <input type="checkbox"/> CLV/PM <input type="checkbox"/> EZOLV Set n8-78 [Medium Load Id Current] to the level of the load current (q-axis current) to be applied.	50% (0 - 255%)	1008
n8-77 (05CE) Expert	Heavy Load Iq Level	<input type="checkbox"/> V/f <input type="checkbox"/> CL-V/f <input type="checkbox"/> OLV <input type="checkbox"/> CLV <input type="checkbox"/> AOLV <input checked="" type="checkbox"/> OLV/PM <input type="checkbox"/> AOLV/PM <input type="checkbox"/> CLV/PM <input type="checkbox"/> EZOLV Set n8-49 [Heavy Load Id Current] to the level of the load current (q-axis current) to be applied.	90% (0 - 255%)	1008
n8-78 (05F4) Expert	Medium Load Id Current	<input type="checkbox"/> V/f <input type="checkbox"/> CL-V/f <input type="checkbox"/> OLV <input type="checkbox"/> CLV <input type="checkbox"/> AOLV <input checked="" type="checkbox"/> OLV/PM <input type="checkbox"/> AOLV/PM <input type="checkbox"/> CLV/PM <input type="checkbox"/> EZOLV Sets the level of the pull-in current for mid-range loads.	0% (0 - 255%)	1008
n8-79 (05FE)	Pull-in Current @ Deceleration	<input type="checkbox"/> V/f <input type="checkbox"/> CL-V/f <input type="checkbox"/> OLV <input type="checkbox"/> CLV <input type="checkbox"/> AOLV <input checked="" type="checkbox"/> OLV/PM <input type="checkbox"/> AOLV/PM <input type="checkbox"/> CLV/PM <input type="checkbox"/> EZOLV Sets, the pull-in current allowed to flow during deceleration as a percentage of the motor rated current. <b>Note:</b> When n8-79 = 0, the drive will use the value set in n8-51 [Pull-in Current @ Acceleration].	0% (0 - 200%)	1008
n8-84 (02D3) Expert	Polarity Detection Current	<input type="checkbox"/> V/f <input type="checkbox"/> CL-V/f <input type="checkbox"/> OLV <input type="checkbox"/> CLV <input type="checkbox"/> AOLV <input checked="" type="checkbox"/> OLV/PM <input type="checkbox"/> AOLV/PM <input type="checkbox"/> CLV/PM <input type="checkbox"/> EZOLV Sets the current that the drive uses to estimate the initial motor magnetic pole as a percentage where E5-03 [PM Motor Rated Current (FLA)] = 100%.	100% (0 - 150%)	1008
n8-94 (012D) Expert	Flux Position Estimation Method	<input type="checkbox"/> V/f <input type="checkbox"/> CL-V/f <input type="checkbox"/> OLV <input type="checkbox"/> CLV <input type="checkbox"/> AOLV <input type="checkbox"/> OLV/PM <input checked="" type="checkbox"/> AOLV/PM <input type="checkbox"/> CLV/PM <input type="checkbox"/> EZOLV Sets the criteria that the drive uses to find changes in speed or load. Usually it is not necessary to change this setting. 0 : Softstarter 1 : Speed Feedback	Determined by d5-01 (0, 1)	1009
n8-95 (012E) Expert	Flux Position Est Filter Time	<input type="checkbox"/> V/f <input type="checkbox"/> CL-V/f <input type="checkbox"/> OLV <input type="checkbox"/> CLV <input type="checkbox"/> AOLV <input type="checkbox"/> OLV/PM <input checked="" type="checkbox"/> AOLV/PM <input type="checkbox"/> CLV/PM <input type="checkbox"/> EZOLV Sets the time constant of the filter used for the recognition criteria value for speed and load changes. Usually it is not necessary to change this setting.	30 ms (0 - 100 ms)	1009

## 10.13 o: Keypad-Related Settings

### ◆ o1: Keypad Display

No. (Hex.)	Name	Description	Default (Range)	Ref.
o1-01 (0500) RUN	User Monitor Selection	<p><b>V/f</b> <b>CL-V/f</b> <b>OLV</b> <b>CLV</b> <b>AOLV</b> <b>OLV/PM</b> <b>AOLV/PM</b> <b>CLV/PM</b> <b>EZOLV</b></p> <p>Set the <i>U</i> monitor for the Drive Mode. This parameter is only available when you use an LED keypad.</p> <p><b>Note:</b> You cannot select <i>U2</i> monitor [<i>Fault Trace</i>] or <i>U3</i> Monitor [<i>Fault History</i>].</p>	106 (104 - 855)	1011
o1-02 (0501) RUN	Monitor Selection at Power-up	<p><b>V/f</b> <b>CL-V/f</b> <b>OLV</b> <b>CLV</b> <b>AOLV</b> <b>OLV/PM</b> <b>AOLV/PM</b> <b>CLV/PM</b> <b>EZOLV</b></p> <p>Sets the monitor item that the keypad screen shows after energizing the drive. Refer to “U: Monitors” for information about the monitor items that the keypad screen can show. This parameter is only available when using an LED keypad.</p> <p>1 : Frequency Reference (U1-01) 2 : Direction 3 : Output Frequency (U1-02) 4 : Output Current (U1-03) 5 : User Monitor (o1-01)</p>	1 (1 - 5)	1011
o1-03 (0502)	Frequency Display Unit Selection	<p><b>V/f</b> <b>CL-V/f</b> <b>OLV</b> <b>CLV</b> <b>AOLV</b> <b>OLV/PM</b> <b>AOLV/PM</b> <b>CLV/PM</b> <b>EZOLV</b></p> <p>Sets the display units for the frequency reference and output frequency.</p> <p>0 : 0.01 Hz 1 : 0.01% (100% = E1-04) 2 : Revolutions Per Minute (RPM) 3 : User Units (o1-10 &amp; o1-11)</p>	Determined by A1-02 (0 - 3)	1011
o1-04 (0503)	V/f Pattern Display Unit	<p><b>V/f</b> <b>CL-V/f</b> <b>OLV</b> <b>CLV</b> <b>AOLV</b> <b>OLV/PM</b> <b>AOLV/PM</b> <b>CLV/PM</b> <b>EZOLV</b></p> <p>Sets the setting unit for parameters that set the V/f pattern frequency.</p> <p>0 : Hz 1 : Revolutions Per Minute (RPM)</p>	Determined by A1-02 (0, 1)	1012
o1-05 (0504) RUN	LCD Contrast Adjustment	<p><b>V/f</b> <b>CL-V/f</b> <b>OLV</b> <b>CLV</b> <b>AOLV</b> <b>OLV/PM</b> <b>AOLV/PM</b> <b>CLV/PM</b> <b>EZOLV</b></p> <p>Sets the contrast of the LCD display on the keypad.</p>	5 (0 - 10)	1013
o1-10 (0520)	User Units Maximum Value	<p><b>V/f</b> <b>CL-V/f</b> <b>OLV</b> <b>CLV</b> <b>AOLV</b> <b>OLV/PM</b> <b>AOLV/PM</b> <b>CLV/PM</b> <b>EZOLV</b></p> <p>Sets the value that the drive shows as the maximum output frequency.</p>	Determined by o1-03 (1 - 60000)	1013
o1-11 (0521)	User Units Decimal Position	<p><b>V/f</b> <b>CL-V/f</b> <b>OLV</b> <b>CLV</b> <b>AOLV</b> <b>OLV/PM</b> <b>AOLV/PM</b> <b>CLV/PM</b> <b>EZOLV</b></p> <p>Sets the number of decimal places for frequency reference and monitor values.</p> <p>0 : No Decimal Places (XXXXX) 1 : One Decimal Places (XXXX.X) 2 : Two Decimal Places (XXX.XX) 3 : Three Decimal Places (XX.XXX)</p>	Determined by o1-03 (0 - 3)	1013
o1-24 to o1-35 (11AD - 11B8) RUN	Custom Monitor 1 to 12	<p><b>V/f</b> <b>CL-V/f</b> <b>OLV</b> <b>CLV</b> <b>AOLV</b> <b>OLV/PM</b> <b>AOLV/PM</b> <b>CLV/PM</b> <b>EZOLV</b></p> <p>Sets a maximum of 12 monitors as user monitors. This parameter is only available with an LED keypad.</p>	o1-24: 101 o1-25: 102 o1-26: 103 o1-27 to o1-35: 0 (0, 101 - 999)	1013
o1-36 (11B9) RUN	LCD Backlight Brightness	<p><b>V/f</b> <b>CL-V/f</b> <b>OLV</b> <b>CLV</b> <b>AOLV</b> <b>OLV/PM</b> <b>AOLV/PM</b> <b>CLV/PM</b> <b>EZOLV</b></p> <p>Sets the intensity of the LCD keypad backlight.</p>	3 (1 - 5)	1014
o1-37 (11BA) RUN	LCD Backlight ON/OFF Selection	<p><b>V/f</b> <b>CL-V/f</b> <b>OLV</b> <b>CLV</b> <b>AOLV</b> <b>OLV/PM</b> <b>AOLV/PM</b> <b>CLV/PM</b> <b>EZOLV</b></p> <p>Sets the automatic shut off function for the LCD backlight.</p> <p>0 : OFF 1 : ON</p>	1 (0, 1)	1014

No. (Hex.)	Name	Description	Default (Range)	Ref.
o1-38 (11BB) RUN	LCD Backlight Off-Delay	<b>V/f</b> <b>CL-V/f</b> <b>OLV</b> <b>CLV</b> <b>AOLV</b> <b>OLV/PM</b> <b>AOLV/PM</b> <b>CLV/PM</b> <b>EZOLV</b> Sets the time until the LCD backlight automatically turns off.	60 s (10 - 300 s)	1014
o1-39 (11BC) RUN	Show Initial Setup Screen	<b>V/f</b> <b>CL-V/f</b> <b>OLV</b> <b>CLV</b> <b>AOLV</b> <b>OLV/PM</b> <b>AOLV/PM</b> <b>CLV/PM</b> <b>EZOLV</b> Sets the function to show the LCD keypad initial setup screen each time the drive is energized. This parameter is only available when using an LCD keypad. 0 : No 1 : Yes	1 (0, 1)	1014
o1-40 (11BD) RUN	Home Screen Display Selection	<b>V/f</b> <b>CL-V/f</b> <b>OLV</b> <b>CLV</b> <b>AOLV</b> <b>OLV/PM</b> <b>AOLV/PM</b> <b>CLV/PM</b> <b>EZOLV</b> Sets the monitor display mode for the Home screen. This parameter is only available when using an LCD keypad. 0 : Custom Monitor 1 : Bar Graph 2 : Analog Gauge 3 : Trend Plot	0 (0 - 3)	1015
o1-41 (11C1) RUN	1st Monitor Area Selection	<b>V/f</b> <b>CL-V/f</b> <b>OLV</b> <b>CLV</b> <b>AOLV</b> <b>OLV/PM</b> <b>AOLV/PM</b> <b>CLV/PM</b> <b>EZOLV</b> Sets the horizontal axis used to show the monitor that was set in o1-24 [Custom Monitor 1] as a bar graph. This parameter is only available with an LCD keypad. 0 : +/- Area (- o1-42 ~ o1-42) 1 : + Area (0 ~ o1-42) 2 : - Area (- o1-42 ~ 0)	0 (0 - 2)	1015
o1-42 (11C2) RUN	1st Monitor Area Setting	<b>V/f</b> <b>CL-V/f</b> <b>OLV</b> <b>CLV</b> <b>AOLV</b> <b>OLV/PM</b> <b>AOLV/PM</b> <b>CLV/PM</b> <b>EZOLV</b> Sets the horizontal axis value used to display the monitor that was set in o1-24 [Custom Monitor 1] as a bar graph. This parameter is only available with an LCD keypad.	100.0% (0.0 - 100.0%)	1015
o1-43 (11C3) RUN	2nd Monitor Area Selection	<b>V/f</b> <b>CL-V/f</b> <b>OLV</b> <b>CLV</b> <b>AOLV</b> <b>OLV/PM</b> <b>AOLV/PM</b> <b>CLV/PM</b> <b>EZOLV</b> Sets the horizontal axis used to show the monitor that was set in o1-25 as a bar graph. This parameter is only available with an LCD keypad. 0 : +/- Area (- o1-44 ~ o1-44) 1 : + Area (0 ~ o1-44) 2 : - Area (- o1-44 ~ 0)	0 (0 - 2)	1015
o1-44 (11C4) RUN	2nd Monitor Area Setting	<b>V/f</b> <b>CL-V/f</b> <b>OLV</b> <b>CLV</b> <b>AOLV</b> <b>OLV/PM</b> <b>AOLV/PM</b> <b>CLV/PM</b> <b>EZOLV</b> Sets the horizontal axis value used to display the monitor that was set in o1-25 [Custom Monitor 2] as a bar graph. This parameter is only available with an LCD keypad.	100.0% (0.0 - 100.0%)	1016
o1-45 (11C5) RUN	3rd Monitor Area Selection	<b>V/f</b> <b>CL-V/f</b> <b>OLV</b> <b>CLV</b> <b>AOLV</b> <b>OLV/PM</b> <b>AOLV/PM</b> <b>CLV/PM</b> <b>EZOLV</b> Sets the horizontal axis used to show the monitor that was set in o1-26 as a bar graph. This parameter is only available with an LCD keypad. 0 : +/- Area (- o1-46 ~ o1-46) 1 : + Area (0 ~ o1-46) 2 : - Area (- o1-46 ~ 0)	0 (0 - 2)	1016
o1-46 (11C6) RUN	3rd Monitor Area Setting	<b>V/f</b> <b>CL-V/f</b> <b>OLV</b> <b>CLV</b> <b>AOLV</b> <b>OLV/PM</b> <b>AOLV/PM</b> <b>CLV/PM</b> <b>EZOLV</b> Sets the horizontal axis value used to display the monitor that was set in o1-26 [Custom Monitor 3] as a bar graph. This parameter is only available with an LCD keypad.	100.0% (0.0 - 100.0%)	1016
o1-47 (11C7) RUN	Trend Plot 1 Scale Minimum Value	<b>V/f</b> <b>CL-V/f</b> <b>OLV</b> <b>CLV</b> <b>AOLV</b> <b>OLV/PM</b> <b>AOLV/PM</b> <b>CLV/PM</b> <b>EZOLV</b> Sets the minimum value for the vertical axis used to display the monitor that was set in o1-24 [Custom Monitor 1] as a trend plot. This parameter is only available with an LCD keypad.	100% (-300 - +300%)	1016
o1-48 (11C8) RUN	Trend Plot 1 Scale Maximum Value	<b>V/f</b> <b>CL-V/f</b> <b>OLV</b> <b>CLV</b> <b>AOLV</b> <b>OLV/PM</b> <b>AOLV/PM</b> <b>CLV/PM</b> <b>EZOLV</b> Sets the maximum value for the vertical axis used to display the monitor that was set in o1-24 [Custom Monitor 1] as a trend plot. This parameter is only available with an LCD keypad.	100.0% (-99.9 - +300.0%)	1016
o1-49 (11C9) RUN	Trend Plot 2 Scale Minimum Value	<b>V/f</b> <b>CL-V/f</b> <b>OLV</b> <b>CLV</b> <b>AOLV</b> <b>OLV/PM</b> <b>AOLV/PM</b> <b>CLV/PM</b> <b>EZOLV</b> Sets the minimum value for the vertical axis used to display the monitor that was set in o1-25 [Custom Monitor 2] as a trend plot. This parameter is only available with an LCD keypad.	100% (-300 - +300%)	1016

## 10.13 o: Keypad-Related Settings

No. (Hex.)	Name	Description	Default (Range)	Ref.
o1-50 (11CA) RUN	Trend Plot 2 Scale Maximum Value	 Sets the maximum value for the vertical axis used to display the monitor that was set in o1-25 [Custom Monitor 2] as a trend plot. This parameter is only available with an LCD keypad.	100.0% (-99.9 - +300.0%)	1017
o1-51 (11CB) RUN	Trend Plot Time Scale Setting	 Sets the time scale (horizontal axis) to display the trend plot. When you change this setting, the drive automatically adjusts the data sampling time. This parameter is only available with an LCD keypad.	300 s (1 - 3600 s)	1017
o1-55 (11EE) RUN	Analog Gauge Area Selection	 Sets the range used to display the monitor set in o1-24 [Custom Monitor 1] as an analog gauge. This parameter is only available with an LCD keypad. 0 : +/- Area (- o1-56 ~ o1-56) 1 : + Area (0 ~ o1-56)	1 (0, 1)	1017
o1-56 (11EF) RUN	Analog Gauge Area Setting	 Sets the value used to display the monitor set in o1-24 [Custom Monitor 1] as an analog meter. This parameter is only available with an LCD keypad.	100.0% (0.0 - 100.0%)	1017

## ◆ o2: Keypad Operation

No. (Hex.)	Name	Description	Default (Range)	Ref.
o2-01 (0505)	LO/RE Key Function Selection	 Sets the function that lets the drive switch between LOCAL and REMOTE Modes using the  button. 0 : Disabled 1 : Enabled	1 (0, 1)	1017
o2-02 (0506)	STOP Key Function Selection	 Sets the function to stop the drive with the  button on the keypad when the Run command source for the drive is REMOTE (external) and not assigned to the keypad. 0 : Disabled 1 : Enabled	1 (0, 1)	1018
o2-03 (0507)	User Parameter Default Value	 Sets the function to keep the settings of changed parameters as user parameter defaults to use during initialization. 0 : No change 1 : Set defaults 2 : Clear all	0 (0 - 2)	1018
o2-04 (0508)	Drive Model (KVA) Selection	 Sets the Drive Model code. Set this parameter after replacing the control board.	Determined by the drive (-)	1019
o2-05 (0509)	Home Mode Freq Ref Entry Mode	 Sets the function that makes it necessary to push the  button to change the frequency reference value with the keypad when in Drive Mode. 0 : ENTER Key Required 1 : Immediate / MOP-style	0 (0, 1)	1019
o2-06 (050A)	Keypad Disconnect Detection	 Sets the function that stops the drive if you disconnect the keypad connection cable from the drive or if you damage the cable while the keypad is the Run command source. 0 : Disabled 1 : Enabled	Determined by o2-09 (0, 1)	1020

No. (Hex.)	Name	Description	Default (Range)	Ref.
o2-07 (0527)	Keypad RUN Direction @ Power-up	<b>V/f</b> <b>CL-V/f</b> <b>OLV</b> <b>CLV</b> <b>AOLV</b> <b>OLV/PM</b> <b>AOLV/PM</b> <b>CLV/PM</b> <b>EZOLV</b> Sets the direction of motor rotation when the drive is energized and the keypad is the Run command source. 0 : Forward 1 : Reverse	0 (0, 1)	1020
o2-09 (050D)	Region Code	-	-	-
o2-23 (11F8)	External 24V Powerloss Detection	<b>V/f</b> <b>CL-V/f</b> <b>OLV</b> <b>CLV</b> <b>AOLV</b> <b>OLV/PM</b> <b>AOLV/PM</b> <b>CLV/PM</b> <b>EZOLV</b> Sets the function to give a warning when the backup external 24 V power supply turns off when the main circuit power supply is in operation. 0 : Disabled 1 : Enabled	0 (0, 1)	1020
o2-24 (11FE)	LED Light Function Selection	<b>V/f</b> <b>CL-V/f</b> <b>OLV</b> <b>CLV</b> <b>AOLV</b> <b>OLV/PM</b> <b>AOLV/PM</b> <b>CLV/PM</b> <b>EZOLV</b> Sets the function to show the LED status rings and keypad LED lamps. 0 : Enable Status Ring & Keypad LED 1 : LED Status Ring Disable 2 : Keypad LED Light Disable	0 (0 - 2)	1021
o2-26 (1563)	Alarm display at ext. 24V power	<b>V/f</b> <b>CL-V/f</b> <b>OLV</b> <b>CLV</b> <b>AOLV</b> <b>OLV/PM</b> <b>AOLV/PM</b> <b>CLV/PM</b> <b>EZOLV</b> When you connect a backup external 24 V power supply, this parameter sets the function to trigger an alarm when the main circuit power supply voltage decreases. <b>Note:</b> The drive will not run when it is operating from one 24-V external power supply. 0 : Disabled 1 : Enabled	0 (0, 1)	1021
o2-27 (1565)	bCE Detection Selection	<b>V/f</b> <b>CL-V/f</b> <b>OLV</b> <b>CLV</b> <b>AOLV</b> <b>OLV/PM</b> <b>AOLV/PM</b> <b>CLV/PM</b> <b>EZOLV</b> Sets drive operation if the Bluetooth device is disconnected when you operate the drive in Bluetooth Mode. 0 : Ramp to Stop 1 : Coast to Stop 2 : Fast Stop (Use C1-09) 3 : Alarm Only 4 : No Alarm Display	3 (0 - 4)	1021

### ◆ o3: Copy Function

No. (Hex.)	Name	Description	Default (Range)	Ref.
o3-01 (0515)	Copy Keypad Function Selection	<b>V/f</b> <b>CL-V/f</b> <b>OLV</b> <b>CLV</b> <b>AOLV</b> <b>OLV/PM</b> <b>AOLV/PM</b> <b>CLV/PM</b> <b>EZOLV</b> Sets the function that saves and copies drive parameters to a different drive with the keypad. 0 : Copy Select 1 : Backup (drive → keypad) 2 : Restore (keypad → drive) 3 : Verify (check for mismatch) 4 : Erase (backup data of keypad)	0 (0 - 4)	1021
o3-02 (0516)	Copy Allowed Selection	<b>V/f</b> <b>CL-V/f</b> <b>OLV</b> <b>CLV</b> <b>AOLV</b> <b>OLV/PM</b> <b>AOLV/PM</b> <b>CLV/PM</b> <b>EZOLV</b> Sets the copy function when o3-01 = 1 [Copy Keypad Function Selection = Backup (drive → keypad)]. 0 : Disabled 1 : Enabled	0 (0, 1)	1022

## 10.13 o: Keypad-Related Settings

No. (Hex.)	Name	Description	Default (Range)	Ref.
o3-04 (0B3E)	Select Backup/Restore Location	<p><b>V/f</b> <b>CL-V/f</b> <b>OLV</b> <b>CLV</b> <b>AOLV</b> <b>OLV/PM</b> <b>AOLV/PM</b> <b>CLV/PM</b> <b>EZOLV</b></p> <p>Sets the storage location for drive parameters when you back up and restore parameters. This parameter is only available with an LCD keypad.</p> <p>0 : Memory Location 1 1 : Memory Location 2 2 : Memory Location 3 3 : Memory Location 4</p>	0 (0 - 3)	1022
o3-05 (0BDA)	Select Items to Backup/Restore	<p><b>V/f</b> <b>CL-V/f</b> <b>OLV</b> <b>CLV</b> <b>AOLV</b> <b>OLV/PM</b> <b>AOLV/PM</b> <b>CLV/PM</b> <b>EZOLV</b></p> <p>Sets which parameters are backed up, restored, and referenced. This parameter is only available with an LED keypad.</p> <p>0 : Standard Parameters 1 : Standard + DWEZ Parameters</p>	0 (0, 1)	1022
o3-06 (0BDE)	Auto Parameter Backup Selection	<p><b>V/f</b> <b>CL-V/f</b> <b>OLV</b> <b>CLV</b> <b>AOLV</b> <b>OLV/PM</b> <b>AOLV/PM</b> <b>CLV/PM</b> <b>EZOLV</b></p> <p>Sets the function that automatically backs up parameters. This parameter is only available when using an LCD keypad.</p> <p>0 : Disabled 1 : Enabled</p>	1 (0, 1)	1022
o3-07 (0BDF)	Auto Parameter Backup Interval	<p><b>V/f</b> <b>CL-V/f</b> <b>OLV</b> <b>CLV</b> <b>AOLV</b> <b>OLV/PM</b> <b>AOLV/PM</b> <b>CLV/PM</b> <b>EZOLV</b></p> <p>Sets the interval at which the automatic parameter backup function saves parameters from the drive to the keypad.</p> <p><b>Note:</b> This parameter is only available with an LED keypad.</p> <p>0 : Every 10 minutes 1 : Every 30 minutes 2 : Every 60 minutes 3 : Every 12 hours</p>	1 (0 - 3)	1023

## ◆ o4: Maintenance Monitors

No. (Hex.)	Name	Description	Default (Range)	Ref.
o4-01 (050B)	Elapsed Operating Time Setting	<p><b>V/f</b> <b>CL-V/f</b> <b>OLV</b> <b>CLV</b> <b>AOLV</b> <b>OLV/PM</b> <b>AOLV/PM</b> <b>CLV/PM</b> <b>EZOLV</b></p> <p>Sets the initial value of the cumulative drive operation time in 10-hour units.</p>	0 h (0 - 9999 h)	1023
o4-02 (050C)	Elapsed Operating Time Selection	<p><b>V/f</b> <b>CL-V/f</b> <b>OLV</b> <b>CLV</b> <b>AOLV</b> <b>OLV/PM</b> <b>AOLV/PM</b> <b>CLV/PM</b> <b>EZOLV</b></p> <p>Sets the condition that counts the cumulative operation time.</p> <p>0 : U4-01 Shows Total Power-up Time 1 : U4-01 Shows Total RUN Time</p>	0 (0, 1)	1023
o4-03 (050E)	Fan Operation Time Setting	<p><b>V/f</b> <b>CL-V/f</b> <b>OLV</b> <b>CLV</b> <b>AOLV</b> <b>OLV/PM</b> <b>AOLV/PM</b> <b>CLV/PM</b> <b>EZOLV</b></p> <p>Sets the value from which to start the cumulative drive cooling fan operation time in 10-hour units.</p>	0 h (0 - 9999 h)	1023
o4-05 (051D)	Capacitor Maintenance Setting	<p><b>V/f</b> <b>CL-V/f</b> <b>OLV</b> <b>CLV</b> <b>AOLV</b> <b>OLV/PM</b> <b>AOLV/PM</b> <b>CLV/PM</b> <b>EZOLV</b></p> <p>Sets the U4-05 [<i>CapacitorMaintenance</i>] monitor value.</p>	0% (0 - 150%)	1024
o4-07 (0523)	Softcharge Relay Maintenance Set	<p><b>V/f</b> <b>CL-V/f</b> <b>OLV</b> <b>CLV</b> <b>AOLV</b> <b>OLV/PM</b> <b>AOLV/PM</b> <b>CLV/PM</b> <b>EZOLV</b></p> <p>Sets the U4-06 [<i>SChgBypassRelayMaint</i>] monitor value.</p>	0% (0 - 150%)	1024
o4-09 (0525)	IGBT Maintenance Setting	<p><b>V/f</b> <b>CL-V/f</b> <b>OLV</b> <b>CLV</b> <b>AOLV</b> <b>OLV/PM</b> <b>AOLV/PM</b> <b>CLV/PM</b> <b>EZOLV</b></p> <p>Sets the U4-07 [<i>IGBT Maintenance</i>] monitor value.</p>	0% (0 - 150%)	1024
o4-11 (0510)	Fault Trace/History Init (U2/U3)	<p><b>V/f</b> <b>CL-V/f</b> <b>OLV</b> <b>CLV</b> <b>AOLV</b> <b>OLV/PM</b> <b>AOLV/PM</b> <b>CLV/PM</b> <b>EZOLV</b></p> <p>Resets the records of Monitors U2-xx [<i>Fault Trace</i>] and U3-xx [<i>Fault History</i>].</p> <p>0 : Disabled 1 : Enabled</p>	0 (0, 1)	1024

No. (Hex.)	Name	Description	Default (Range)	Ref.
o4-12 (0512)	kWh Monitor Initialization	<b>V/f</b> <b>CL-V/f</b> <b>OLV</b> <b>CLV</b> <b>AOLV</b> <b>OLV/PM</b> <b>AOLV/PM</b> <b>CLV/PM</b> <b>EZOLV</b> Resets the monitor values for U4-10 [kWh, Lower 4 Digits] and U4-11 [kWh, Upper 5 Digits]. 0 : No Reset 1 : Reset	0 (0, 1)	1025
o4-13 (0528)	RUN Command Counter @ Initialize	<b>V/f</b> <b>CL-V/f</b> <b>OLV</b> <b>CLV</b> <b>AOLV</b> <b>OLV/PM</b> <b>AOLV/PM</b> <b>CLV/PM</b> <b>EZOLV</b> Resets the monitor values for U4-02 [Num of Run Commands], U4-24 [Number of Runs (Low)], and U4-25 [Number of Runs(High)]. 0 : No Reset 1 : Reset	0 (0, 1)	1025
o4-22 (154F) RUN	Time Format	<b>V/f</b> <b>CL-V/f</b> <b>OLV</b> <b>CLV</b> <b>AOLV</b> <b>OLV/PM</b> <b>AOLV/PM</b> <b>CLV/PM</b> <b>EZOLV</b> Sets the time display format. This parameter is only available when using an LCD keypad. 0 : 24 Hour Clock 1 : 12 Hour Clock 2 : 12 Hour JP Clock	0 (0 - 2)	1025
o4-23 (1550) RUN	Date Format	<b>V/f</b> <b>CL-V/f</b> <b>OLV</b> <b>CLV</b> <b>AOLV</b> <b>OLV/PM</b> <b>AOLV/PM</b> <b>CLV/PM</b> <b>EZOLV</b> Sets the date display format. This parameter is only available when using an LED keypad. 0 : YYYY/MM/DD 1 : DD/MM/YYYY 2 : MM/DD/YYYY	0 (0 - 2)	1025
o4-24 (310F) RUN	bAT Detection Selection	<b>V/f</b> <b>CL-V/f</b> <b>OLV</b> <b>CLV</b> <b>AOLV</b> <b>OLV/PM</b> <b>AOLV/PM</b> <b>CLV/PM</b> <b>EZOLV</b> Sets operation when the drive detects bAT [Keypad Battery Low Voltage] and TiM [Keypad Time Not Set]. 0 : Disable 1 : Enable (Alarm Detected) 2 : Enable (Fault Detected)	0 (0 - 2)	1026

## ◆ o5: Log Function

No. (Hex.)	Name	Description	Default (Range)	Ref.
o5-01 (1551) RUN	Log Start/Stop Selection	<b>V/f</b> <b>CL-V/f</b> <b>OLV</b> <b>CLV</b> <b>AOLV</b> <b>OLV/PM</b> <b>AOLV/PM</b> <b>CLV/PM</b> <b>EZOLV</b> Sets the data log function. This parameter is only available on an LCD keypad. 0 : OFF 1 : ON	0 (0 - 1)	1029
o5-02 (1552) RUN	Log Sampling Interval	<b>V/f</b> <b>CL-V/f</b> <b>OLV</b> <b>CLV</b> <b>AOLV</b> <b>OLV/PM</b> <b>AOLV/PM</b> <b>CLV/PM</b> <b>EZOLV</b> Sets the data log sampling cycle. This parameter is only available on an LCD keypad.	1000 ms (100 - 6000 ms)	1029
o5-03 (1553) RUN	Log Monitor Data 1	<b>V/f</b> <b>CL-V/f</b> <b>OLV</b> <b>CLV</b> <b>AOLV</b> <b>OLV/PM</b> <b>AOLV/PM</b> <b>CLV/PM</b> <b>EZOLV</b> Sets the data log monitor. This parameter is only available on an LCD keypad.	101 (000,101 - 855)	1029
o5-04 (1554) RUN	Log Monitor Data 2	<b>V/f</b> <b>CL-V/f</b> <b>OLV</b> <b>CLV</b> <b>AOLV</b> <b>OLV/PM</b> <b>AOLV/PM</b> <b>CLV/PM</b> <b>EZOLV</b> Sets the data log monitor. This parameter is only available on an LCD keypad.	102 (000,101 - 855)	1029
o5-05 (1555) RUN	Log Monitor Data 3	<b>V/f</b> <b>CL-V/f</b> <b>OLV</b> <b>CLV</b> <b>AOLV</b> <b>OLV/PM</b> <b>AOLV/PM</b> <b>CLV/PM</b> <b>EZOLV</b> Sets the data log monitor. This parameter is only available on an LCD keypad.	103 (000,101 - 855)	1030
o5-06 (1556) RUN	Log Monitor Data 4	<b>V/f</b> <b>CL-V/f</b> <b>OLV</b> <b>CLV</b> <b>AOLV</b> <b>OLV/PM</b> <b>AOLV/PM</b> <b>CLV/PM</b> <b>EZOLV</b> Sets the data log monitor. This parameter is only available on an LCD keypad.	107 (000,101 - 855)	1030
o5-07 (1557) RUN	Log Monitor Data 5	<b>V/f</b> <b>CL-V/f</b> <b>OLV</b> <b>CLV</b> <b>AOLV</b> <b>OLV/PM</b> <b>AOLV/PM</b> <b>CLV/PM</b> <b>EZOLV</b> Sets the data log monitor. This parameter is only available on an LCD keypad.	108 (000,101 - 855)	1030

## 10.13 o: Keypad-Related Settings

No. (Hex.)	Name	Description	Default (Range)	Ref.
o5-08 (1558) RUN	Log Monitor Data 6	<b>V/f</b> <b>CL-V/f</b> <b>OLV</b> <b>CLV</b> <b>AOLV</b> <b>OLV/PM</b> <b>AOLV/PM</b> <b>CLV/PM</b> <b>EZOLV</b> Sets the data log monitor. This parameter is only available on an LCD keypad.	000 (000,101 - 855)	1030
o5-09 (1559) RUN	Log Monitor Data 7	<b>V/f</b> <b>CL-V/f</b> <b>OLV</b> <b>CLV</b> <b>AOLV</b> <b>OLV/PM</b> <b>AOLV/PM</b> <b>CLV/PM</b> <b>EZOLV</b> Sets the data log monitor. This parameter is only available on an LCD keypad.	000 (000,101 - 855)	1030
o5-10 (155A) RUN	Log Monitor Data 8	<b>V/f</b> <b>CL-V/f</b> <b>OLV</b> <b>CLV</b> <b>AOLV</b> <b>OLV/PM</b> <b>AOLV/PM</b> <b>CLV/PM</b> <b>EZOLV</b> Sets the data log monitor. This parameter is only available on an LCD keypad.	000 (000,101 - 855)	1031
o5-11 (155B) RUN	Log Monitor Data 9	<b>V/f</b> <b>CL-V/f</b> <b>OLV</b> <b>CLV</b> <b>AOLV</b> <b>OLV/PM</b> <b>AOLV/PM</b> <b>CLV/PM</b> <b>EZOLV</b> Sets the data log monitor. This parameter is only available on an LCD keypad.	000 (000,101 - 855)	1031
o5-12 (155C) RUN	Log Monitor Data 10	<b>V/f</b> <b>CL-V/f</b> <b>OLV</b> <b>CLV</b> <b>AOLV</b> <b>OLV/PM</b> <b>AOLV/PM</b> <b>CLV/PM</b> <b>EZOLV</b> Sets the data log monitor. This parameter is only available on an LCD keypad.	000 (000,101 - 855)	1031



## 10.14 q: DriveWorksEZ Parameters

### ◆ q1-01 to q8-40: Reserved for DriveWorksEZ

No. (Hex.)	Name	Description	Default (Range)
q1-01 to q8-40: (1600 to 17E7)	Reserved for DriveWorksEZ	<div style="display: flex; justify-content: space-between; font-size: 0.8em; font-weight: bold; margin-bottom: 5px;"> <span>V/f</span> <span>CL-V/f</span> <span>OLV</span> <span>CLV</span> <span>AOLV</span> <span>OLV/PM</span> <span>AOLV/PM</span> <span>CLV/PM</span> <span>EZOLV</span> </div> These parameters are reserved for use with DriveWorksEZ.	Refer to "DriveWorksEZ Operation Manual".

## 10.15 r: DWEZ Connection 1-20

### ◆ r1-01 to r1-40: DriveWorksEZ Connection Parameters 1 to 20 (Upper / Lower)

No. (Hex.)	Name	Description	Default (Range)
r1-01 to r1-40: (1840 to 1867)	DriveWorksEZ Connection Parameters 1 to 20 (Upper / Lower)	<div style="display: flex; justify-content: space-between; font-size: small; font-weight: bold;"> <span>V/f</span> <span>CL-V/f</span> <span>OLV</span> <span>CLV</span> <span>AOLV</span> <span>OLV/PM</span> <span>AOLV/PM</span> <span>CLV/PM</span> <span>EZOLV</span> </div> DriveWorksEZ Connection Parameters 1 to 20 (Upper / Lower)	0 (0 - FFFFH)

## 10.16 T: Motor Tuning

### ◆ T0: Tuning Mode Selection

No. (Hex.)	Name	Description	Default (Range)	Ref.
T0-00 (1197)	Tuning Mode Selection	<p><b>V/f</b> <b>CL-V/f</b> <b>OLV</b> <b>CLV</b> <b>AOLV</b> <b>OLV/PM</b> <b>AOLV/PM</b> <b>CLV/PM</b> <b>EZOLV</b></p> <p>Sets the type of Auto-Tuning. 0 : Motor Parameter Tuning 1 : Control Tuning</p>	0 (0, 1)	1032

### ◆ T1: InductionMotor Auto-Tuning

No. (Hex.)	Name	Description	Default (Range)	Ref.
T1-00 (0700)	Motor 1/Motor 2 Selection	<p><b>V/f</b> <b>CL-V/f</b> <b>OLV</b> <b>CLV</b> <b>AOLV</b> <b>OLV/PM</b> <b>AOLV/PM</b> <b>CLV/PM</b> <b>EZOLV</b></p> <p>Sets which motor to tune when motor 1/2 switching is enabled. You can only use the keypad to set this parameter. You cannot use external input terminals to set it.</p> <p><b>Note:</b> Set <i>H1-xx = 16 [Motor 2 Selection]</i> ON to set this parameter. The keypad will not show this parameter when <i>H1-xx = 16</i> is OFF. 1 : Motor 1 (sets E1-00, E2-00) 2 : Motor 2 (sets E3-00, E4-00)</p>	1 (1, 2)	1032
T1-01 (0701)	Auto-Tuning Mode Selection	<p><b>V/f</b> <b>CL-V/f</b> <b>OLV</b> <b>CLV</b> <b>AOLV</b> <b>OLV/PM</b> <b>AOLV/PM</b> <b>CLV/PM</b> <b>EZOLV</b></p> <p>Sets the type of Auto-Tuning. 0 : Rotational Auto-Tuning 1 : Stationary Auto-Tuning 1 2 : Stationary Line-Line Resistance</p>	Determined by A1-02 (Determined by A1-02)	1033
T1-02 (0702)	Motor Rated Power	<p><b>V/f</b> <b>CL-V/f</b> <b>OLV</b> <b>CLV</b> <b>AOLV</b> <b>OLV/PM</b> <b>AOLV/PM</b> <b>CLV/PM</b> <b>EZOLV</b></p> <p>Sets the rated output power (kW) of the motor.</p>	Determined by o2-04 and C6-01 (0.00 - 650.00 kW)	1033
T1-03 (0703)	Motor Rated Voltage	<p><b>V/f</b> <b>CL-V/f</b> <b>OLV</b> <b>CLV</b> <b>AOLV</b> <b>OLV/PM</b> <b>AOLV/PM</b> <b>CLV/PM</b> <b>EZOLV</b></p> <p>Sets the rated voltage (V) of the motor. Enter the base speed voltage for constant output motors.</p>	Determined by o2-04 and C6-01 (200 V Class: 0.0 - 255.5 V, 400 V Class: 0.0 - 511.0 V)	1033
T1-04 (0704)	Motor Rated Current	<p><b>V/f</b> <b>CL-V/f</b> <b>OLV</b> <b>CLV</b> <b>AOLV</b> <b>OLV/PM</b> <b>AOLV/PM</b> <b>CLV/PM</b> <b>EZOLV</b></p> <p>Sets the rated current (A) of the motor.</p>	Determined by o2-04 (10% to 200% of the drive rated current)	1033
T1-05 (0705)	Motor Base Frequency	<p><b>V/f</b> <b>CL-V/f</b> <b>OLV</b> <b>CLV</b> <b>AOLV</b> <b>OLV/PM</b> <b>AOLV/PM</b> <b>CLV/PM</b> <b>EZOLV</b></p> <p>Sets the base frequency (Hz) of the motor.</p>	50.0 Hz (0.0 - 590.0 Hz)	1033
T1-06 (0706)	Number of Motor Poles	<p><b>V/f</b> <b>CL-V/f</b> <b>OLV</b> <b>CLV</b> <b>AOLV</b> <b>OLV/PM</b> <b>AOLV/PM</b> <b>CLV/PM</b> <b>EZOLV</b></p> <p>Sets the number of motor poles.</p>	4 (2 - 48)	1034
T1-07 (0707)	Motor Base Speed	<p><b>V/f</b> <b>CL-V/f</b> <b>OLV</b> <b>CLV</b> <b>AOLV</b> <b>OLV/PM</b> <b>AOLV/PM</b> <b>CLV/PM</b> <b>EZOLV</b></p> <p>Sets the motor base speed for Auto-Tuning (min<sup>-1</sup> (r/min)).</p>	1450 min <sup>-1</sup> (r/min) (0 - 35400 min <sup>-1</sup> (r/min))	1034
T1-08 (0708)	Encoder Pulse Count (PPR)	<p><b>V/f</b> <b>CL-V/f</b> <b>OLV</b> <b>CLV</b> <b>AOLV</b> <b>OLV/PM</b> <b>AOLV/PM</b> <b>CLV/PM</b> <b>EZOLV</b></p> <p>Sets the number of PG (pulse generator, encoder) pulses.</p>	1024 ppr (0 - 60,000 ppr)	1034
T1-09 (0709)	Motor No-Load Current	<p><b>V/f</b> <b>CL-V/f</b> <b>OLV</b> <b>CLV</b> <b>AOLV</b> <b>OLV/PM</b> <b>AOLV/PM</b> <b>CLV/PM</b> <b>EZOLV</b></p> <p>Sets the no-load current of the motor.</p>	- (0A - T1-04; max. of 2999.9)	1034
T1-10 (070A)	Motor Rated Slip Frequency	<p><b>V/f</b> <b>CL-V/f</b> <b>OLV</b> <b>CLV</b> <b>AOLV</b> <b>OLV/PM</b> <b>AOLV/PM</b> <b>CLV/PM</b> <b>EZOLV</b></p> <p>Sets the motor rated slip.</p>	- (0.000 - 20.000 Hz)	1034

No. (Hex.)	Name	Description	Default (Range)	Ref.
T1-11 (070B)	Motor Iron Loss	<input type="checkbox"/> V/f <input type="checkbox"/> CL-V/f <input type="checkbox"/> OLV <input type="checkbox"/> CLV <input type="checkbox"/> AOLV <input checked="" type="checkbox"/> OLV/PM <input checked="" type="checkbox"/> AOLV/PM <input checked="" type="checkbox"/> CLV/PM <input type="checkbox"/> EZOLV Sets the iron loss for calculating the energy-saving coefficient.	Determined by E2-11 or E4-11 (0 - 65535 W)	1034
T1-12 (0BDB)	Test Mode Selection	<input type="checkbox"/> V/f <input type="checkbox"/> CL-V/f <input checked="" type="checkbox"/> OLV <input checked="" type="checkbox"/> CLV <input type="checkbox"/> AOLV <input type="checkbox"/> OLV/PM <input type="checkbox"/> AOLV/PM <input type="checkbox"/> CLV/PM <input type="checkbox"/> EZOLV Sets the function to enable Test Mode after Stationary Auto-Tuning. When you can operate the motor with a light load attached after Stationary Auto-Tuning is complete, enable this parameter. <b>Note:</b> You must first set T1-10 [Motor Rated Slip Frequency] = 0 Hz to enable this parameter. 0 : No 1 : Yes	0 (0, 1)	1035
T1-13 (0BDC)	No-load voltage	<input type="checkbox"/> V/f <input type="checkbox"/> CL-V/f <input checked="" type="checkbox"/> OLV <input checked="" type="checkbox"/> CLV <input type="checkbox"/> AOLV <input type="checkbox"/> OLV/PM <input type="checkbox"/> AOLV/PM <input type="checkbox"/> CLV/PM <input type="checkbox"/> EZOLV Sets the no-load voltage of the motor. If no-load voltage is necessary at rated speed for the motor test report, set the voltage in this parameter. If the motor test report is not available, do not change this parameter. <b>Note:</b> To get the same qualities as a Yaskawa 1000-series drive or previous models, set this parameter = T1-03 [Motor Rated Voltage] value.	90% of T1-03 (200 V Class: 0.0 - 255.0 V, 400 V Class: 0.0 - 510.0 V)	1035

◆ T2: PM Motor Auto-Tuning

No. (Hex.)	Name	Description	Default (Range)	Ref.
T2-01 (0750)	PM Auto-Tuning Selection	<input type="checkbox"/> V/f <input type="checkbox"/> CL-V/f <input type="checkbox"/> OLV <input type="checkbox"/> CLV <input type="checkbox"/> AOLV <input checked="" type="checkbox"/> OLV/PM <input checked="" type="checkbox"/> AOLV/PM <input checked="" type="checkbox"/> CLV/PM <input type="checkbox"/> EZOLV Sets the type of Auto-Tuning for PM motors. 0 : Manual Entry w/ Motor Data Sheet 1 : Stationary (Ld, Lq, R) 2 : Stationary (R Only) 3 : Z-Pulse Offset (Pole Position) 4 : Rotational (Ld, Lq, R, back-EMF)	0 (Determined by A1-02)	1035
T2-02 (0751)	PM Motor Code Selection	<input type="checkbox"/> V/f <input type="checkbox"/> CL-V/f <input type="checkbox"/> OLV <input type="checkbox"/> CLV <input type="checkbox"/> AOLV <input checked="" type="checkbox"/> OLV/PM <input checked="" type="checkbox"/> AOLV/PM <input checked="" type="checkbox"/> CLV/PM <input type="checkbox"/> EZOLV Sets the PM motor code for drives operating SMRA, SSR1, or SST4-series Yaskawa PM motors.	Determined by A1-02 and o2-04 (0000 - FFFF)	1036
T2-03 (0752)	PM Motor Type	<input type="checkbox"/> V/f <input type="checkbox"/> CL-V/f <input type="checkbox"/> OLV <input type="checkbox"/> CLV <input type="checkbox"/> AOLV <input checked="" type="checkbox"/> OLV/PM <input checked="" type="checkbox"/> AOLV/PM <input checked="" type="checkbox"/> CLV/PM <input type="checkbox"/> EZOLV Sets the type of PM motor the drive will operate. 0 : IPM motor 1 : SPM motor	1 (0, 1)	1036
T2-04 (0730)	PM Motor Rated Power	<input type="checkbox"/> V/f <input type="checkbox"/> CL-V/f <input type="checkbox"/> OLV <input type="checkbox"/> CLV <input type="checkbox"/> AOLV <input checked="" type="checkbox"/> OLV/PM <input checked="" type="checkbox"/> AOLV/PM <input checked="" type="checkbox"/> CLV/PM <input type="checkbox"/> EZOLV Sets the rated output power (kW) of a PM motor.	Determined by o2-04 and C6-01 (0.00 - 650.00 kW)	1036
T2-05 (0732)	PM Motor Rated Voltage	<input type="checkbox"/> V/f <input type="checkbox"/> CL-V/f <input type="checkbox"/> OLV <input type="checkbox"/> CLV <input type="checkbox"/> AOLV <input checked="" type="checkbox"/> OLV/PM <input checked="" type="checkbox"/> AOLV/PM <input checked="" type="checkbox"/> CLV/PM <input type="checkbox"/> EZOLV Sets the rated voltage (V) of the motor.	200 V Class: 200.0 V, 400 V Class: 400.0 V (200 V Class: 0.0 - 255.0 V, 400 V Class: 0.0 - 510.0 V)	1036
T2-06 (0733)	PM Motor Rated Current	<input type="checkbox"/> V/f <input type="checkbox"/> CL-V/f <input type="checkbox"/> OLV <input type="checkbox"/> CLV <input type="checkbox"/> AOLV <input checked="" type="checkbox"/> OLV/PM <input checked="" type="checkbox"/> AOLV/PM <input checked="" type="checkbox"/> CLV/PM <input type="checkbox"/> EZOLV Sets the rated current (A) of the motor.	Determined by o2-04 (10% to 200% of the drive rated current)	1036
T2-07 (0753)	PM Motor Base Frequency	<input type="checkbox"/> V/f <input type="checkbox"/> CL-V/f <input type="checkbox"/> OLV <input type="checkbox"/> CLV <input type="checkbox"/> AOLV <input checked="" type="checkbox"/> OLV/PM <input checked="" type="checkbox"/> AOLV/PM <input checked="" type="checkbox"/> CLV/PM <input type="checkbox"/> EZOLV Sets the base frequency (Hz) of the motor.	87.5 Hz (0.0 - 590.0 Hz)	1036
T2-08 (0734)	Number of PM Motor Poles	<input type="checkbox"/> V/f <input type="checkbox"/> CL-V/f <input type="checkbox"/> OLV <input type="checkbox"/> CLV <input type="checkbox"/> AOLV <input checked="" type="checkbox"/> OLV/PM <input checked="" type="checkbox"/> AOLV/PM <input checked="" type="checkbox"/> CLV/PM <input type="checkbox"/> EZOLV Sets the number of motor poles.	6 (2 - 48)	1037

No. (Hex.)	Name	Description	Default (Range)	Ref.
T2-09 (0731)	PM Motor Base Speed	<input type="checkbox"/> V/f <input type="checkbox"/> CL-V/f <input type="checkbox"/> OLV <input type="checkbox"/> CLV <input type="checkbox"/> AOLV <input type="checkbox"/> OLV/PM <input type="checkbox"/> AOLV/PM <input checked="" type="checkbox"/> CLV/PM <input type="checkbox"/> EZOLV Sets the motor base speed ( $\text{min}^{-1}$ (r/min)).	1750 $\text{min}^{-1}$ (r/min) (0 - 34500 $\text{min}^{-1}$ (r/min))	1037
T2-10 (0754)	PM Motor Stator Resistance	<input type="checkbox"/> V/f <input type="checkbox"/> CL-V/f <input type="checkbox"/> OLV <input type="checkbox"/> CLV <input type="checkbox"/> AOLV <input checked="" type="checkbox"/> OLV/PM <input type="checkbox"/> AOLV/PM <input checked="" type="checkbox"/> CLV/PM <input type="checkbox"/> EZOLV Sets the stator resistance for each motor phase. <b>Note:</b> This parameter does not set line-to-line resistance.	Determined by T2-02 (0.000 - 65.000 $\Omega$ )	1037
T2-11 (0735)	PM Motor d-Axis Inductance	<input type="checkbox"/> V/f <input type="checkbox"/> CL-V/f <input type="checkbox"/> OLV <input type="checkbox"/> CLV <input type="checkbox"/> AOLV <input checked="" type="checkbox"/> OLV/PM <input type="checkbox"/> AOLV/PM <input checked="" type="checkbox"/> CLV/PM <input type="checkbox"/> EZOLV Sets the d-axis inductance of the motor on a per phase basis.	Determined by T2-02 (0.00 - 600.00 mH)	1037
T2-12 (0736)	PM Motor q-Axis Inductance	<input type="checkbox"/> V/f <input type="checkbox"/> CL-V/f <input type="checkbox"/> OLV <input type="checkbox"/> CLV <input type="checkbox"/> AOLV <input checked="" type="checkbox"/> OLV/PM <input type="checkbox"/> AOLV/PM <input checked="" type="checkbox"/> CLV/PM <input type="checkbox"/> EZOLV Sets the q-Axis inductance of the motor on a per phase basis.	Determined by T2-02 (0.00 - 600.00 mH)	1037
T2-13 (0755)	Back-EMF Units Selection	<input type="checkbox"/> V/f <input type="checkbox"/> CL-V/f <input type="checkbox"/> OLV <input type="checkbox"/> CLV <input type="checkbox"/> AOLV <input checked="" type="checkbox"/> OLV/PM <input type="checkbox"/> AOLV/PM <input checked="" type="checkbox"/> CLV/PM <input type="checkbox"/> EZOLV Sets the units that the drive uses to set the induced voltage constant. 0 : mV/(rev/min) 1 : mV/(rad/sec)	1 (0, 1)	1037
T2-14 (0737)	Back-EMF Voltage Constant (Ke)	<input type="checkbox"/> V/f <input type="checkbox"/> CL-V/f <input type="checkbox"/> OLV <input type="checkbox"/> CLV <input type="checkbox"/> AOLV <input checked="" type="checkbox"/> OLV/PM <input type="checkbox"/> AOLV/PM <input checked="" type="checkbox"/> CLV/PM <input type="checkbox"/> EZOLV Sets the motor induced voltage constant (Ke).	Determined by T2-13 (0.0 - 2000.0)	1037
T2-15 (0756)	Pull-In Current Level	<input type="checkbox"/> V/f <input type="checkbox"/> CL-V/f <input type="checkbox"/> OLV <input type="checkbox"/> CLV <input type="checkbox"/> AOLV <input checked="" type="checkbox"/> OLV/PM <input type="checkbox"/> AOLV/PM <input checked="" type="checkbox"/> CLV/PM <input type="checkbox"/> EZOLV Sets the level of the pull-in current as a percentage, where 100% = motor rated current. Usually it is not necessary to change this setting.	30% (0 - 120%)	1038
T2-16 (0738)	Encoder Pulse Count (PPR)	<input type="checkbox"/> V/f <input type="checkbox"/> CL-V/f <input type="checkbox"/> OLV <input type="checkbox"/> CLV <input type="checkbox"/> AOLV <input checked="" type="checkbox"/> OLV/PM <input type="checkbox"/> AOLV/PM <input checked="" type="checkbox"/> CLV/PM <input type="checkbox"/> EZOLV Sets the number of PG (pulse generator, encoder) pulses.	1024 ppr (1 - 15000 ppr)	1038
T2-17 (0757)	Encoder Z-Pulse Offset	<input type="checkbox"/> V/f <input type="checkbox"/> CL-V/f <input type="checkbox"/> OLV <input type="checkbox"/> CLV <input type="checkbox"/> AOLV <input checked="" type="checkbox"/> OLV/PM <input type="checkbox"/> AOLV/PM <input checked="" type="checkbox"/> CLV/PM <input type="checkbox"/> EZOLV Sets the encoder Z-pulse offset ( $\Delta\theta$ ) (pulse generator, encoder) that is listed on the motor nameplate.	0.0° (-180.0 - +180.0°)	1038

### ◆ T3: ASR and Inertia Tuning

No. (Hex.)	Name	Description	Default (Range)	Ref.
T3-00 (1198)	Control Loop Tuning Selection	<input type="checkbox"/> V/f <input type="checkbox"/> CL-V/f <input type="checkbox"/> OLV <input checked="" type="checkbox"/> CLV <input type="checkbox"/> AOLV <input type="checkbox"/> OLV/PM <input type="checkbox"/> AOLV/PM <input checked="" type="checkbox"/> CLV/PM <input type="checkbox"/> EZOLV Sets the type of Control Auto-Tuning. 0 : Inertia Tuning 1 : ASR (Speed Regulator) 2 : Deceleration Rate Tuning 3 : KEB Tuning <b>Note:</b> Settings 0 and 1 are available only when A1-02 = 3, 7 [Control Method Selection = Closed Loop Vector, PM Closed Loop Vector].	0 (0 - 3)	1038
T3-01 (0760)	Test Signal Frequency	<input type="checkbox"/> V/f <input type="checkbox"/> CL-V/f <input type="checkbox"/> OLV <input checked="" type="checkbox"/> CLV <input type="checkbox"/> AOLV <input type="checkbox"/> OLV/PM <input type="checkbox"/> AOLV/PM <input checked="" type="checkbox"/> CLV/PM <input type="checkbox"/> EZOLV Sets the frequency of the test signal applied to the motor during Inertia Tuning. Usually it is not necessary to change this setting.	3.0 Hz (0.1 - 20.0 Hz)	1038
T3-02 (0761)	Test Signal Amplitude	<input type="checkbox"/> V/f <input type="checkbox"/> CL-V/f <input type="checkbox"/> OLV <input checked="" type="checkbox"/> CLV <input type="checkbox"/> AOLV <input type="checkbox"/> OLV/PM <input type="checkbox"/> AOLV/PM <input checked="" type="checkbox"/> CLV/PM <input type="checkbox"/> EZOLV Sets the amplitude of the test signal applied to the motor during Inertia Tuning. Usually it is not necessary to change this setting.	0.5 rad (0.1 - 10.0 rad)	1038

No. (Hex.)	Name	Description	Default (Range)	Ref.
T3-03 (0762)	Motor Inertia	<div style="display: flex; justify-content: space-between; font-size: 0.8em; margin-bottom: 5px;"> <span>V/f</span> <span>CL-V/f</span> <span>OLV</span> <span style="background-color: #ccc;">CLV</span> <span>AOLV</span> <span>OLV/PM</span> <span>AOLV/PM</span> <span style="background-color: #ccc;">CLV/PM</span> <span>EZOLV</span> </div> Sets the inertia of the motor. This value uses the test signal response to calculate the load inertia.	Determined by o2-04, C6-01, and E5-01 (0.0001 - 6.0000 kgm <sup>2</sup> )	1039
T3-04 (0763)	System Response Frequency	<div style="display: flex; justify-content: space-between; font-size: 0.8em; margin-bottom: 5px;"> <span>V/f</span> <span>CL-V/f</span> <span>OLV</span> <span style="background-color: #ccc;">CLV</span> <span>AOLV</span> <span>OLV/PM</span> <span>AOLV/PM</span> <span style="background-color: #ccc;">CLV/PM</span> <span>EZOLV</span> </div> This parameter uses the load inertia value from the Inertia Tuning process to automatically calculate and set C5-01 [ASR Proportional Gain 1].	10.0 Hz (0.1 - 50.0 Hz)	1039

◆ T4: EZ Tuning

No. (Hex.)	Name	Description	Default (Range)	Ref.
T4-01 (3130)	EZ Tuning Mode Selection	<div style="display: flex; justify-content: space-between; font-size: 0.8em; margin-bottom: 5px;"> <span>V/f</span> <span>CL-V/f</span> <span>OLV</span> <span>CLV</span> <span>AOLV</span> <span>OLV/PM</span> <span>AOLV/PM</span> <span>CLV/PM</span> <span style="background-color: #ccc;">EZOLV</span> </div> Sets the type of Auto-Tuning for EZOLV control. 0 : Motor Parameter Setting 1 : Line-to-Line Resistance	0 (0, 1)	1039
T4-02 (3131)	Motor Type Selection	<div style="display: flex; justify-content: space-between; font-size: 0.8em; margin-bottom: 5px;"> <span>V/f</span> <span>CL-V/f</span> <span>OLV</span> <span>CLV</span> <span>AOLV</span> <span>OLV/PM</span> <span>AOLV/PM</span> <span>CLV/PM</span> <span style="background-color: #ccc;">EZOLV</span> </div> Sets the type of motor. 0 : Induction (IM) 1 : Permanent Magnet (PM) 2 : Synchronous Reluctance (SynRM)	0 (0, 1, 2)	1040
T4-03 (3132)	Motor Max Revolutions	<div style="display: flex; justify-content: space-between; font-size: 0.8em; margin-bottom: 5px;"> <span>V/f</span> <span>CL-V/f</span> <span>OLV</span> <span>CLV</span> <span>AOLV</span> <span>OLV/PM</span> <span>AOLV/PM</span> <span>CLV/PM</span> <span style="background-color: #ccc;">EZOLV</span> </div> Sets the maximum motor revolutions (min <sup>-1</sup> ).	- ((40 to 120 Hz) × 60 × 2 / E9-08)	1040
T4-04 (3133)	Motor Rated Revolutions	<div style="display: flex; justify-content: space-between; font-size: 0.8em; margin-bottom: 5px;"> <span>V/f</span> <span>CL-V/f</span> <span>OLV</span> <span>CLV</span> <span>AOLV</span> <span>OLV/PM</span> <span>AOLV/PM</span> <span>CLV/PM</span> <span style="background-color: #ccc;">EZOLV</span> </div> Sets rated rotation speed (min <sup>-1</sup> ) of the motor.	- ((40 to 120 Hz) × 60 × 2 / E9-08)	1040
T4-05 (3134)	Motor Rated Frequency	<div style="display: flex; justify-content: space-between; font-size: 0.8em; margin-bottom: 5px;"> <span>V/f</span> <span>CL-V/f</span> <span>OLV</span> <span>CLV</span> <span>AOLV</span> <span>OLV/PM</span> <span>AOLV/PM</span> <span>CLV/PM</span> <span style="background-color: #ccc;">EZOLV</span> </div> Sets the rated frequency (Hz) of the motor.	Determined by E9-01 and o2-04 (40.0 - 120.0 Hz)	1040
T4-06 (3135)	Motor Rated Voltage	<div style="display: flex; justify-content: space-between; font-size: 0.8em; margin-bottom: 5px;"> <span>V/f</span> <span>CL-V/f</span> <span>OLV</span> <span>CLV</span> <span>AOLV</span> <span>OLV/PM</span> <span>AOLV/PM</span> <span>CLV/PM</span> <span style="background-color: #ccc;">EZOLV</span> </div> Sets the rated voltage (V) of the motor.	200 V Class: 200.0 V, 400 V Class: 400.0 V (200 V Class: 0.0 - 255.0 V, 400 V Class: 0.0 - 510.0 V)	1040
T4-07 (3136)	Motor Rated Current	<div style="display: flex; justify-content: space-between; font-size: 0.8em; margin-bottom: 5px;"> <span>V/f</span> <span>CL-V/f</span> <span>OLV</span> <span>CLV</span> <span>AOLV</span> <span>OLV/PM</span> <span>AOLV/PM</span> <span>CLV/PM</span> <span style="background-color: #ccc;">EZOLV</span> </div> Sets the rated current (A) of the motor.	Determined by o2-04 and C6-01 (10% to 200% of the drive rated current)	1040
T4-08 (3137)	Motor Rated Capacity	<div style="display: flex; justify-content: space-between; font-size: 0.8em; margin-bottom: 5px;"> <span>V/f</span> <span>CL-V/f</span> <span>OLV</span> <span>CLV</span> <span>AOLV</span> <span>OLV/PM</span> <span>AOLV/PM</span> <span>CLV/PM</span> <span style="background-color: #ccc;">EZOLV</span> </div> Sets the motor rated capacity in 0.01 kW units.	Determined by E9-10 (0.10 - 650.00 kW)	1041
T4-09 (3138)	Number of Poles	<div style="display: flex; justify-content: space-between; font-size: 0.8em; margin-bottom: 5px;"> <span>V/f</span> <span>CL-V/f</span> <span>OLV</span> <span>CLV</span> <span>AOLV</span> <span>OLV/PM</span> <span>AOLV/PM</span> <span>CLV/PM</span> <span style="background-color: #ccc;">EZOLV</span> </div> Sets the number of motor poles.	Determined by E9-01 (2 - 48)	1041

## 10.17 U: Monitors

### ◆ U1: Operation Status Monitors

No. (Hex.)	Name	Description	MFAO Signal Level	Ref.
U1-01 (0040)	Frequency Reference	<p><b>V/f</b> <b>CL-V/f</b> <b>OLV</b> <b>CLV</b> <b>AOLV</b> <b>OLV/PM</b> <b>AOLV/PM</b> <b>CLV/PM</b> <b>EZOLV</b></p> <p>Shows the actual frequency reference value. Parameter <i>o1-03</i> [<i>Frequency Display Unit Selection</i>] selects the units. Unit: 0.01 Hz</p>	10 V = Max. frequency (-10 V to +10 V)	-
U1-02 (0041)	Output Frequency	<p><b>V/f</b> <b>CL-V/f</b> <b>OLV</b> <b>CLV</b> <b>AOLV</b> <b>OLV/PM</b> <b>AOLV/PM</b> <b>CLV/PM</b> <b>EZOLV</b></p> <p>Shows the actual output frequency. Parameter <i>o1-03</i> [<i>Frequency Display Unit Selection</i>] selects the units. Unit: 0.01 Hz</p>	10 V = Max. frequency (-10 V to +10 V)	-
U1-03 (0042)	Output Current	<p><b>V/f</b> <b>CL-V/f</b> <b>OLV</b> <b>CLV</b> <b>AOLV</b> <b>OLV/PM</b> <b>AOLV/PM</b> <b>CLV/PM</b> <b>EZOLV</b></p> <p>Shows the actual output current. The keypad shows the value of <i>U1-03</i> in amperes (A). When looking at the monitor through MEMOBUS/Modbus communications, the current is "8192 = drive rated current (A)." Calculate the current from the monitor value that is in at MEMOBUS/Modbus communications using "Numerals being displayed / 8192 × drive rated current (A)." Unit: Determined by the drive model.  <ul style="list-style-type: none"> <li>0.01 A: 2004 to 2042, 4002 to 4023</li> <li>0.1 A: 2056 to 2415, 4031 to 4675</li> </ul> </p>	10 V = Drive rated current	-
U1-04 (0043)	Control Method	<p><b>V/f</b> <b>CL-V/f</b> <b>OLV</b> <b>CLV</b> <b>AOLV</b> <b>OLV/PM</b> <b>AOLV/PM</b> <b>CLV/PM</b> <b>EZOLV</b></p> <p>Shows the drive control method.            0 : V/f Control            1 : V/f Control with Encoder            2 : Open Loop Vector            3 : Closed Loop Vector            4 : Advanced Open Loop Vector            5 : PM Open Loop Vector            6 : PM Advanced Open Loop Vector            7 : PM Closed Loop Vector            8 : EZ Vector Control</p>	No signal output available	-
U1-05 (0044)	Motor Speed	<p><b>V/f</b> <b>CL-V/f</b> <b>OLV</b> <b>CLV</b> <b>AOLV</b> <b>OLV/PM</b> <b>AOLV/PM</b> <b>CLV/PM</b> <b>EZOLV</b></p> <p>Shows the actual detected motor speed. Parameter <i>o1-03</i> [<i>Frequency Display Unit Selection</i>] selects the units. Unit: 0.01 Hz</p>	10 V = Max. frequency (-10 V to +10 V)	-
U1-06 (0045)	Output Voltage Ref	<p><b>V/f</b> <b>CL-V/f</b> <b>OLV</b> <b>CLV</b> <b>AOLV</b> <b>OLV/PM</b> <b>AOLV/PM</b> <b>CLV/PM</b> <b>EZOLV</b></p> <p>Shows the output voltage reference. Unit: 0.1 V</p>	200 V class: 10 V = 200 Vrms 400 V class: 10 V = 400 Vrms	-
U1-07 (0046)	DC Bus Voltage	<p><b>V/f</b> <b>CL-V/f</b> <b>OLV</b> <b>CLV</b> <b>AOLV</b> <b>OLV/PM</b> <b>AOLV/PM</b> <b>CLV/PM</b> <b>EZOLV</b></p> <p>Shows the DC bus voltage. Unit: 1 V</p>	200 V class: 10 V = 200 V 400 V class: 10 V = 400 V	-
U1-08 (0047)	Output Power	<p><b>V/f</b> <b>CL-V/f</b> <b>OLV</b> <b>CLV</b> <b>AOLV</b> <b>OLV/PM</b> <b>AOLV/PM</b> <b>CLV/PM</b> <b>EZOLV</b></p> <p>Shows the internally-calculated output power. Changing the setting of <i>A1-02</i> [<i>Control Method Selection</i>] also changes the signal level of the analog output.  <ul style="list-style-type: none"> <li><i>A1-02</i> = 0, 1 [<i>V/f Control</i>]: Drive capacity (kW)</li> <li><i>A1-02</i> = 2 to 8 [<i>Vector Control</i>]: Motor Rated Power (kW) [E2-11]</li> </ul>           Unit: Drive capacity and <i>C6-01</i> [<i>Normal / Heavy Duty Selection</i>] calculate the maximum applicable motor output.  <ul style="list-style-type: none"> <li>Less than 11 kW (15 HP): 0.01 kW</li> <li>Less than 11 kW (15 HP): 0.1 kW</li> </ul> </p>	10 V: Drive capacity (motor rated power) kW (-10 V to +10 V)	-

No. (Hex.)	Name	Description	MFAO Signal Level	Ref.
U1-09 (0048)	Torque Reference	<p><b>V/f</b> <b>CL-V/f</b> <b>OLV</b> <b>CLV</b> <b>AOLV</b> <b>OLV/PM</b> <b>AOLV/PM</b> <b>CLV/PM</b> <b>EZOLV</b></p> <p>Shows the internal torque reference value. Unit: 0.1%</p>	10 V = Motor rated torque (-10 V to +10 V)	-
U1-10 (0049)	Input Terminal Status	<p><b>V/f</b> <b>CL-V/f</b> <b>OLV</b> <b>CLV</b> <b>AOLV</b> <b>OLV/PM</b> <b>AOLV/PM</b> <b>CLV/PM</b> <b>EZOLV</b></p> <p>Shows the status of the MFDI terminal where 1 = (ON) and 0 = (OFF). For example, <i>U1-10</i> shows "00000011" when terminals S1 and S2 are ON. bit 0 : Terminal S1 (MFDI 1) bit 1 : Terminal S2 (MFDI 2) bit 2 : Terminal S3 (MFDI 3) bit 3 : Terminal S4 (MFDI 4) bit 4 : Terminal S5 (MFDI 5) bit 5 : Terminal S6 (MFDI 6) bit 6 : Terminal S7 (MFDI 7) bit 7 : Terminal S8 (MFDI 8)</p>	No signal output available	-
U1-11 (004A)	Output Terminal Status	<p><b>V/f</b> <b>CL-V/f</b> <b>OLV</b> <b>CLV</b> <b>AOLV</b> <b>OLV/PM</b> <b>AOLV/PM</b> <b>CLV/PM</b> <b>EZOLV</b></p> <p>Shows the status of the MFDO terminal where 1 = (ON) and 0 = (OFF). For example, <i>U1-11</i> shows "00000011" when terminals M1 and M3 are ON. bit 0 : Terminals M1-M2 bit 1 : Terminals M3-M4 bit 2 : Terminals M5-M6 bit 3 : Not used (normal value of 0). bit 4 : Not used (normal value of 0). bit 5 : Not used (normal value of 0). bit 6 : Not used (normal value of 0). bit 7 : Fault relay MA/MB-MC</p>	No signal output available	-
U1-12 (004B)	Drive Status	<p><b>V/f</b> <b>CL-V/f</b> <b>OLV</b> <b>CLV</b> <b>AOLV</b> <b>OLV/PM</b> <b>AOLV/PM</b> <b>CLV/PM</b> <b>EZOLV</b></p> <p>Shows drive status where 1 = (ON) and 0 = (OFF). For example, <i>U1-12</i> shows "00000101" during run with the Reverse Run command. bit 0 : During run bit 1 : During zero-speed bit 2 : During reverse bit 3 : During fault reset signal input bit 4 : During speed agreement bit 5 : Drive ready bit 6 : During minor fault detection bit 7 : During fault detection</p>	No signal output available	-
U1-13 (004E)	Terminal A1 Level	<p><b>V/f</b> <b>CL-V/f</b> <b>OLV</b> <b>CLV</b> <b>AOLV</b> <b>OLV/PM</b> <b>AOLV/PM</b> <b>CLV/PM</b> <b>EZOLV</b></p> <p>Shows the signal level of terminal A1. Unit: 0.1%</p>	10 V = 100% (-10 V to +10 V)	-
U1-14 (004F)	Terminal A2 Level	<p><b>V/f</b> <b>CL-V/f</b> <b>OLV</b> <b>CLV</b> <b>AOLV</b> <b>OLV/PM</b> <b>AOLV/PM</b> <b>CLV/PM</b> <b>EZOLV</b></p> <p>Shows the signal level of terminal A2. Unit: 0.1%</p>	10 V = 100% (-10 V to +10 V)	-
U1-15 (0050)	Terminal A3 Level	<p><b>V/f</b> <b>CL-V/f</b> <b>OLV</b> <b>CLV</b> <b>AOLV</b> <b>OLV/PM</b> <b>AOLV/PM</b> <b>CLV/PM</b> <b>EZOLV</b></p> <p>Shows the signal level of terminal A3. Unit: 0.1%</p>	0 V = 100% (-10 V to +10 V)	-
U1-16 (0053)	SFS Output Frequency	<p><b>V/f</b> <b>CL-V/f</b> <b>OLV</b> <b>CLV</b> <b>AOLV</b> <b>OLV/PM</b> <b>AOLV/PM</b> <b>CLV/PM</b> <b>EZOLV</b></p> <p>Shows the output frequency after soft start. Shows the frequency with acceleration and deceleration times and S-curves. Parameter <i>o1-03</i> [Frequency Display Unit Selection] selects the units. Unit: 0.01 Hz</p>	10 V = Max. frequency (-10 V to +10 V)	-



No. (Hex.)	Name	Description	MFAO Signal Level	Ref.
U1-17 (0058)	DI-A3 Input Status	<b>V/f</b> <b>CL-V/f</b> <b>OLV</b> <b>CLV</b> <b>AOLV</b> <b>OLV/PM</b> <b>AOLV/PM</b> <b>CLV/PM</b> <b>EZOLV</b> Shows the reference value input from DI-A3 option. Shows the input signal for DI-A3 in hexadecimal as set in F3-01 [Digital Input Function Selection]. 3FFFF: Set (1 bit) + Sign (1 bit) + 16 bit	No signal output available	-
U1-18 (0061)	oPE Fault Parameter	<b>V/f</b> <b>CL-V/f</b> <b>OLV</b> <b>CLV</b> <b>AOLV</b> <b>OLV/PM</b> <b>AOLV/PM</b> <b>CLV/PM</b> <b>EZOLV</b> Shows the parameter number that caused the oPE02 [Parameter Range Setting Error] or oPE08 [Parameter Selection Error].	No signal output available	-
U1-19 (0066)	MEMOBUS/Modbus Error Code	<b>V/f</b> <b>CL-V/f</b> <b>OLV</b> <b>CLV</b> <b>AOLV</b> <b>OLV/PM</b> <b>AOLV/PM</b> <b>CLV/PM</b> <b>EZOLV</b> Shows the contents of the MEMOBUS/Modbus communication error where 1 = (error) and 0 = (no error). For example, U1-19 shows "00000001" when a CRC error occurs. bit 0 : CRC Error bit 1 : Data Length Error bit 2 : Not used (normal value of 0). bit 3 : Parity Error bit 4 : Overrun Error bit 5 : Framing Error bit 6 : Timed Out bit 7 : Not used (normal value of 0).	No signal output available	-
U1-21 (0077)	AI-A3 Term V1 Level	<b>V/f</b> <b>CL-V/f</b> <b>OLV</b> <b>CLV</b> <b>AOLV</b> <b>OLV/PM</b> <b>AOLV/PM</b> <b>CLV/PM</b> <b>EZOLV</b> Shows the analog reference of terminal V1 on analog input option card AI-A3. Unit: 0.1%	10 V = 100% (-10 V to +10 V)	-
U1-22 (072A)	AI-A3 Term V2 Level	<b>V/f</b> <b>CL-V/f</b> <b>OLV</b> <b>CLV</b> <b>AOLV</b> <b>OLV/PM</b> <b>AOLV/PM</b> <b>CLV/PM</b> <b>EZOLV</b> Shows the analog reference of terminal V2 on analog input option card AI-A3. Unit: 0.1%	10 V = 100% (-10 V to +10 V)	-
U1-23 (072B)	AI-A3 Term V3 Level	<b>V/f</b> <b>CL-V/f</b> <b>OLV</b> <b>CLV</b> <b>AOLV</b> <b>OLV/PM</b> <b>AOLV/PM</b> <b>CLV/PM</b> <b>EZOLV</b> Shows the analog reference of terminal V3 on analog input option card AI-A3. Unit: 0.1%	10 V = 100% (-10 V to +10 V)	-
U1-24 (007D)	Input Pulse Monitor	<b>V/f</b> <b>CL-V/f</b> <b>OLV</b> <b>CLV</b> <b>AOLV</b> <b>OLV/PM</b> <b>AOLV/PM</b> <b>CLV/PM</b> <b>EZOLV</b> Shows the frequency to pulse train input terminal RP. Unit: 1 Hz	Determined by H6-02	-
U1-25 (004D)	SoftwareNumber Flash	<b>V/f</b> <b>CL-V/f</b> <b>OLV</b> <b>CLV</b> <b>AOLV</b> <b>OLV/PM</b> <b>AOLV/PM</b> <b>CLV/PM</b> <b>EZOLV</b> Shows the FLASH ID.	No signal output available	-
U1-26 (005B)	SoftwareNumber ROM	<b>V/f</b> <b>CL-V/f</b> <b>OLV</b> <b>CLV</b> <b>AOLV</b> <b>OLV/PM</b> <b>AOLV/PM</b> <b>CLV/PM</b> <b>EZOLV</b> Shows the ROM ID.	No signal output available	-
U1-50 (1199) Expert	Virtual Analog Input	<b>V/f</b> <b>CL-V/f</b> <b>OLV</b> <b>CLV</b> <b>AOLV</b> <b>OLV/PM</b> <b>AOLV/PM</b> <b>CLV/PM</b> <b>EZOLV</b> Shows the virtual analog input value.	Determined by H7-40	-
U1-91 (154E) Expert	Output Voltage	<b>V/f</b> <b>CL-V/f</b> <b>OLV</b> <b>CLV</b> <b>AOLV</b> <b>OLV/PM</b> <b>AOLV/PM</b> <b>CLV/PM</b> <b>EZOLV</b> Shows the drive internal output voltage reference. Unit: 0.1 V	200 V class: 10 V = 200 Vrms 400 V class: 10 V = 400 Vrms	-

## ◆ U2: Fault Trace

No. (Hex.)	Name	Description	MFAO Signal Level	Ref.
U2-01 (0080)	Current Fault	<b>V/f</b> <b>CL-V/f</b> <b>OLV</b> <b>CLV</b> <b>AOLV</b> <b>OLV/PM</b> <b>AOLV/PM</b> <b>CLV/PM</b> <b>EZOLV</b> Shows the fault that the drive has when viewing the monitor.	No signal output available	-
U2-02 (0081)	Previous Fault	<b>V/f</b> <b>CL-V/f</b> <b>OLV</b> <b>CLV</b> <b>AOLV</b> <b>OLV/PM</b> <b>AOLV/PM</b> <b>CLV/PM</b> <b>EZOLV</b> Shows the fault that occurred most recently.	No signal output available	-

No. (Hex.)	Name	Description	MFAO Signal Level	Ref.
U2-03 (0082)	Freq Reference@Fault	<p><b>V/f</b> <b>CL-V/f</b> <b>OLV</b> <b>CLV</b> <b>AOLV</b> <b>OLV/PM</b> <b>AOLV/PM</b> <b>CLV/PM</b> <b>EZOLV</b></p> <p>Shows the frequency reference at the fault that occurred most recently. Use <i>UI-01 [Frequency Reference]</i> to monitor the actual frequency reference value. Unit: 0.01 Hz</p>	No signal output available	-
U2-04 (0083)	Output Freq @ Fault	<p><b>V/f</b> <b>CL-V/f</b> <b>OLV</b> <b>CLV</b> <b>AOLV</b> <b>OLV/PM</b> <b>AOLV/PM</b> <b>CLV/PM</b> <b>EZOLV</b></p> <p>Shows the output frequency at the fault that occurred most recently. Use <i>UI-02 [Output Frequency]</i> to monitor the actual output frequency. Unit: 0.01 Hz</p>	No signal output available	-
U2-05 (0084)	Output Current@Fault	<p><b>V/f</b> <b>CL-V/f</b> <b>OLV</b> <b>CLV</b> <b>AOLV</b> <b>OLV/PM</b> <b>AOLV/PM</b> <b>CLV/PM</b> <b>EZOLV</b></p> <p>Shows the output current at the fault that occurred most recently. Use <i>UI-03 [Output Current]</i> to monitor the actual output current. The keypad shows the value of <i>UI-03</i> in amperes (A). When looking at the monitor through MEMOBUS/Modbus communications, the current is "8192 = drive rated current (A)". Calculate the current from the monitor value that is in at MEMOBUS/Modbus communications using "Numerals being displayed / 8192 × drive rated current (A)". Unit: Determined by the drive model. • 0.01 A: 2004 to 2042, 4002 to 4023 • 0.1 A: 2056 to 2415, 4031 to 4675</p>	No signal output available	-
U2-06 (0085)	Motor Speed @ Fault	<p><b>V/f</b> <b>CL-V/f</b> <b>OLV</b> <b>CLV</b> <b>AOLV</b> <b>OLV/PM</b> <b>AOLV/PM</b> <b>CLV/PM</b> <b>EZOLV</b></p> <p>Shows the motor speed at the fault that occurred most recently. Use <i>UI-05 [Motor Speed]</i> to monitor the actual motor speed. Unit: 0.01 Hz</p>	No signal output available	-
U2-07 (0086)	Output Voltage@Fault	<p><b>V/f</b> <b>CL-V/f</b> <b>OLV</b> <b>CLV</b> <b>AOLV</b> <b>OLV/PM</b> <b>AOLV/PM</b> <b>CLV/PM</b> <b>EZOLV</b></p> <p>Shows the output voltage reference at the fault that occurred most recently. Use <i>UI-06 [Output Voltage Ref]</i> to monitor the actual output voltage reference. Unit: 0.1 V</p>	No signal output available	-
U2-08 (0087)	DC Bus Voltage@Fault	<p><b>V/f</b> <b>CL-V/f</b> <b>OLV</b> <b>CLV</b> <b>AOLV</b> <b>OLV/PM</b> <b>AOLV/PM</b> <b>CLV/PM</b> <b>EZOLV</b></p> <p>Shows the DC bus voltage at the fault that occurred most recently. Use <i>UI-07 [DC Bus Voltage]</i> to monitor the actual DC bus voltage. Unit: 1 V</p>	No signal output available	-
U2-09 (0088)	Output Power @ Fault	<p><b>V/f</b> <b>CL-V/f</b> <b>OLV</b> <b>CLV</b> <b>AOLV</b> <b>OLV/PM</b> <b>AOLV/PM</b> <b>CLV/PM</b> <b>EZOLV</b></p> <p>Shows the output power at the fault that occurred most recently. Use <i>UI-08 [Output Power]</i> to monitor the actual output power. Unit: 0.1 kW</p>	No signal output available	-
U2-10 (0089)	Torque Ref @ Fault	<p><b>V/f</b> <b>CL-V/f</b> <b>OLV</b> <b>CLV</b> <b>AOLV</b> <b>OLV/PM</b> <b>AOLV/PM</b> <b>CLV/PM</b> <b>EZOLV</b></p> <p>Shows the torque reference at the fault that occurred most recently as a percentage of the motor rated torque. Use <i>UI-09 [Torque Reference]</i> to monitor the actual torque reference. Unit: 0.1%</p>	No signal output available	-

No. (Hex.)	Name	Description	MFAO Signal Level	Ref.
U2-11 (008A)	Input Terminal Status @ Fault	<p><b>V/f</b> <b>CL-V/f</b> <b>OLV</b> <b>CLV</b> <b>AOLV</b> <b>OLV/PM</b> <b>AOLV/PM</b> <b>CLV/PM</b> <b>EZOLV</b></p> <p>Shows the status of the MFDI terminals at the most recent fault where 1 = (ON) and 0 = (OFF). For example, U2-11 shows "00000011" when terminals S1 and S2 are ON. Use U1-10 [Input Terminal Status] to monitor the actual MFDI terminal status. bit 0 : Terminal S1 bit 1 : Terminal S2 bit 2 : Terminal S3 bit 3 : Terminal S4 bit 4 : Terminal S5 bit 5 : Terminal S6 bit 6 : Terminal S7 bit 7 : Terminal S8</p>	No signal output available	-
U2-12 (008B)	Output Terminal Status @ Fault	<p><b>V/f</b> <b>CL-V/f</b> <b>OLV</b> <b>CLV</b> <b>AOLV</b> <b>OLV/PM</b> <b>AOLV/PM</b> <b>CLV/PM</b> <b>EZOLV</b></p> <p>Shows the status of the MFDO terminals at the most recent fault where 1 = (ON) and 0 = (OFF). For example, U2-12 shows "00000011" when terminals M1 and M3 are ON. Use U1-11 [Output Terminal Status] to monitor the actual MFDO terminal status. bit 0 : Terminals M1-M2 bit 1 : Terminals M3-M4 bit 2 : Terminals M5-M6 bit 3 : Not used (normal value of 0). bit 4 : Not used (normal value of 0). bit 5 : Not used (normal value of 0). bit 6 : Not used (normal value of 0). bit 7 : Fault relay MA/MB-MC</p>	No signal output available	-
U2-13 (008C)	Operation Status @ Fault	<p><b>V/f</b> <b>CL-V/f</b> <b>OLV</b> <b>CLV</b> <b>AOLV</b> <b>OLV/PM</b> <b>AOLV/PM</b> <b>CLV/PM</b> <b>EZOLV</b></p> <p>Shows the operation status of the drive at the most recent fault where 1 = (ON) and 0 = (OFF). For example, U2-13 shows "00000001" during run. Use U1-12 [Drive Status] to monitor the actual drive status. bit 0 : During run bit 1 : During zero-speed bit 2 : During reverse bit 3 : During fault reset signal input bit 4 : During speed agreement bit 5 : Drive ready bit 6 : During minor fault detection bit 7 : During fault detection</p>	No signal output available	-
U2-14 (008D)	Elapsed Time @ Fault	<p><b>V/f</b> <b>CL-V/f</b> <b>OLV</b> <b>CLV</b> <b>AOLV</b> <b>OLV/PM</b> <b>AOLV/PM</b> <b>CLV/PM</b> <b>EZOLV</b></p> <p>Shows the cumulative operation time of the drive at the fault that occurred most recently. Use U4-01 [Cumulative Ope Time] to monitor the actual cumulative operation time. Unit: 1 h</p>	No signal output available	-
U2-15 (07E0)	SFS Output @ Fault	<p><b>V/f</b> <b>CL-V/f</b> <b>OLV</b> <b>CLV</b> <b>AOLV</b> <b>OLV/PM</b> <b>AOLV/PM</b> <b>CLV/PM</b> <b>EZOLV</b></p> <p>Shows the output frequency after soft start at the fault that occurred most recently. Use U1-16 [SFS Output Frequency] to monitor the actual output frequency after soft start. Unit: 0.01 Hz</p>	No signal output available	-


No. (Hex.)	Name	Description	MFAO Signal Level	Ref.
U2-16 (07E1)	q-Axis Current@Fault	<p><input type="checkbox"/> V/f <input type="checkbox"/> CL-V/f <input type="checkbox"/> OLV <input type="checkbox"/> CLV <input type="checkbox"/> AOLV <input type="checkbox"/> OLV/PM <input type="checkbox"/> AOLV/PM <input type="checkbox"/> CLV/PM <input type="checkbox"/> EZOLV</p> <p>Shows the q-axis current of the motor at the fault that occurred most recently. Use <i>U6-01 [Iq Secondary Current]</i> to monitor the actual q-Axis current of the motor. Unit: 0.1 %</p>	No signal output available	-
U2-17 (07E2)	d-Axis Current@Fault	<p><input type="checkbox"/> V/f <input type="checkbox"/> CL-V/f <input type="checkbox"/> OLV <input type="checkbox"/> CLV <input type="checkbox"/> AOLV <input type="checkbox"/> OLV/PM <input type="checkbox"/> AOLV/PM <input type="checkbox"/> CLV/PM <input type="checkbox"/> EZOLV</p> <p>Shows the d-axis current of the motor at the fault that occurred most recently. Use <i>U6-02 [Id ExcitationCurrent]</i> to monitor the actual d-Axis current of the motor. Unit: 0.1 %</p>	No signal output available	-
U2-19 (07EC)	ControlDeviation@Flt	<p><input type="checkbox"/> V/f <input type="checkbox"/> CL-V/f <input type="checkbox"/> OLV <input type="checkbox"/> CLV <input type="checkbox"/> AOLV <input type="checkbox"/> OLV/PM <input type="checkbox"/> AOLV/PM <input type="checkbox"/> CLV/PM <input type="checkbox"/> EZOLV</p> <p>Shows the amount of control axis deviation (<math>\Delta\theta</math>) at the fault that occurred most recently. Use <i>U6-10 [ContAxisDeviation <math>\Delta\theta</math>]</i> to monitor the actual amount of control axis deviation (<math>\Delta\theta</math>). Unit: 0.1 °</p>	No signal output available	-
U2-20 (008E)	Heatsink Temp @Fault	<p><input type="checkbox"/> V/f <input type="checkbox"/> CL-V/f <input type="checkbox"/> OLV <input type="checkbox"/> CLV <input type="checkbox"/> AOLV <input type="checkbox"/> OLV/PM <input type="checkbox"/> AOLV/PM <input type="checkbox"/> CLV/PM <input type="checkbox"/> EZOLV</p> <p>Shows the heatsink temperature at the fault that occurred most recently. Use <i>U4-08 [Heatsink Temperature]</i> to monitor the actual temperature of the heatsink. Unit: 1 °C</p>	No signal output available	-
U2-21 (1166) Expert	STPo Detect @ Fault	<p><input type="checkbox"/> V/f <input type="checkbox"/> CL-V/f <input type="checkbox"/> OLV <input type="checkbox"/> CLV <input type="checkbox"/> AOLV <input type="checkbox"/> OLV/PM <input type="checkbox"/> AOLV/PM <input type="checkbox"/> CLV/PM <input type="checkbox"/> EZOLV</p> <p>Monitors conditions to detect <i>STPo [Motor Step-Out Detected]</i> faults. The bit for each condition is displayed as ON or OFF. bit 0 : Excessive current bit 1 : Induced voltage deviation bit 2 : d-axis current deviation bit 3 : Motor lock at startup bit 4 : Acceleration stall continue bit 5 : Acceleration stall repeat bit 6 : Not used (normal value of 0). bit 7 : Not used (normal value of 0).</p>	No signal output available	-

◆ U3: Fault History

No. (Hex.)	Name	Description	MFAO Signal Level	Ref.
U3-01 to U3-10 (0090 - 0093) (0804 - 0809)	1st to 10th MostRecent Fault	<p><input type="checkbox"/> V/f <input type="checkbox"/> CL-V/f <input type="checkbox"/> OLV <input type="checkbox"/> CLV <input type="checkbox"/> AOLV <input type="checkbox"/> OLV/PM <input type="checkbox"/> AOLV/PM <input type="checkbox"/> CLV/PM <input type="checkbox"/> EZOLV</p> <p>Shows the fault history of the first to tenth most recent faults. <b>Note:</b> The drive saves the <i>U3-01 to U3-04 [1st to 4th MostRecent Fault]</i> fault histories to two types of registers at the same time for the MEMOBUS/Modbus communications.</p>	No signal output available	-
U3-11 to U3-20 (0094 - 0097, 080E - 0813)	ElapsedTime@1st to 10 Fault	<p><input type="checkbox"/> V/f <input type="checkbox"/> CL-V/f <input type="checkbox"/> OLV <input type="checkbox"/> CLV <input type="checkbox"/> AOLV <input type="checkbox"/> OLV/PM <input type="checkbox"/> AOLV/PM <input type="checkbox"/> CLV/PM <input type="checkbox"/> EZOLV</p> <p>Shows the cumulative operation time when the first to tenth most recent faults occurred. Unit: 1 h <b>Note:</b> The drive saves the <i>U3-11 to U3-14 [ElapsedTime@1st to 4thFault]</i> the cumulative operation time to two types of registers at the same time for the MEMOBUS/Modbus communications.</p>	No signal output available	-

## ◆ U4: Maintenance Monitors

No. (Hex.)	Name	Description	MFAO Signal Level	Ref.
U4-01 (004C)	Cumulative Ope Time	<p><b>V/f</b> <b>CL-V/f</b> <b>OLV</b> <b>CLV</b> <b>AOLV</b> <b>OLV/PM</b> <b>AOLV/PM</b> <b>CLV/PM</b> <b>EZOLV</b></p> <p>Shows the cumulative operation time of the drive.</p> <p>Use parameter <i>o4-01 [Elapsed Operating Time Setting]</i> to reset this monitor. Use parameter <i>o4-02 [Elapsed Operating Time Selection]</i> to select the cumulative operation times from:</p> <ul style="list-style-type: none"> <li>The time from when the drive is energized until it is de-energized.</li> <li>The time at which the Run command is turned ON.</li> </ul> <p>The maximum value that the monitor will show is 99999. The value then resets and starts counting again from 0.</p> <p>Unit: 1 h</p> <p><b>Note:</b> The MEMOBUS/Modbus communication data is shown in 10 h units. Use register 0099H for data in 1 h units.</p>	No signal output available	-
U4-02 (0075)	Num of Run Commands	<p><b>V/f</b> <b>CL-V/f</b> <b>OLV</b> <b>CLV</b> <b>AOLV</b> <b>OLV/PM</b> <b>AOLV/PM</b> <b>CLV/PM</b> <b>EZOLV</b></p> <p>Shows how many times that the drive has received a Run command.</p> <p>Use parameter <i>o4-13 [RUN Command Counter @ Initialize]</i> to reset this monitor. The maximum value that the monitor will show is 65535. The value then resets and starts counting again from 0.</p> <p>Unit: 1</p>	No signal output available	-
U4-03 (0067)	Cooling Fan Ope Time	<p><b>V/f</b> <b>CL-V/f</b> <b>OLV</b> <b>CLV</b> <b>AOLV</b> <b>OLV/PM</b> <b>AOLV/PM</b> <b>CLV/PM</b> <b>EZOLV</b></p> <p>Shows the cumulative operation time of the cooling fans.</p> <p>Use parameter <i>o4-03 [Fan Operation Time Setting]</i> to reset this monitor. The maximum value that the monitor will show is 99999. The value then resets and starts counting again from 0.</p> <p>Unit: 1 h</p> <p><b>Note:</b> The MEMOBUS/Modbus communication data is shown in 10 h units. Use register 009BH for data in 1 h units.</p>	No signal output available	-
U4-04 (007E)	Cool Fan Maintenance	<p><b>V/f</b> <b>CL-V/f</b> <b>OLV</b> <b>CLV</b> <b>AOLV</b> <b>OLV/PM</b> <b>AOLV/PM</b> <b>CLV/PM</b> <b>EZOLV</b></p> <p>Shows the cumulative operation time of the cooling fans as a percentage of the replacement life of the cooling fans.</p> <p>Use parameter <i>o4-03 [Fan Operation Time Setting]</i> to reset this monitor.</p> <p>Unit: 1%</p> <p><b>Note:</b> Replace the cooling fans when this monitor is 90%.</p>	No signal output available	-
U4-05 (007C)	CapacitorMaintenance	<p><b>V/f</b> <b>CL-V/f</b> <b>OLV</b> <b>CLV</b> <b>AOLV</b> <b>OLV/PM</b> <b>AOLV/PM</b> <b>CLV/PM</b> <b>EZOLV</b></p> <p>Shows the operation time of the electrolytic capacitors for the main circuit and control circuit as a percentage of the replacement life of the electrolytic capacitors.</p> <p>Use parameter <i>o4-05 [Capacitor Maintenance Setting]</i> to reset this monitor.</p> <p>Unit: 1%</p> <p><b>Note:</b> Replace the electrolytic capacitor when this monitor is 90%.</p>	No signal output available	-
U4-06 (07D6)	PreChargeRelay Mainte	<p><b>V/f</b> <b>CL-V/f</b> <b>OLV</b> <b>CLV</b> <b>AOLV</b> <b>OLV/PM</b> <b>AOLV/PM</b> <b>CLV/PM</b> <b>EZOLV</b></p> <p>Shows the operation time of the soft charge bypass relay as a percentage of the replacement life of the soft charge bypass relay.</p> <p>Use parameter <i>o4-07 [Softcharge Relay Maintenance Set]</i> to reset this monitor.</p> <p>Unit: 1%</p> <p><b>Note:</b> Replace the drive when this monitor is 90%.</p>	No signal output available	-

No. (Hex.)	Name	Description	MFAO Signal Level	Ref.
U4-07 (07D7)	IGBT Maintenance	<p><b>V/f</b> <b>CL-V/f</b> <b>OLV</b> <b>CLV</b> <b>AOLV</b> <b>OLV/PM</b> <b>AOLV/PM</b> <b>CLV/PM</b> <b>EZOLV</b></p> <p>Shows the operation time of the IGBTs as a percentage of the replacement life of the IGBTs. Set parameter <i>o4-09 [IGBT Maintenance Setting]</i> to reset this monitor. Unit: 1% <b>Note:</b> Replace the drive when this monitor is 90%.</p>	No signal output available	-
U4-08 (0068)	Heatsink Temperature	<p><b>V/f</b> <b>CL-V/f</b> <b>OLV</b> <b>CLV</b> <b>AOLV</b> <b>OLV/PM</b> <b>AOLV/PM</b> <b>CLV/PM</b> <b>EZOLV</b></p> <p>Shows the heatsink temperature of the drive. Unit: 1 °C</p>	10 V: 100 °C	-
U4-09 (005E)	LED Check	<p><b>V/f</b> <b>CL-V/f</b> <b>OLV</b> <b>CLV</b> <b>AOLV</b> <b>OLV/PM</b> <b>AOLV/PM</b> <b>CLV/PM</b> <b>EZOLV</b></p> <p>Turns on the LED Status Ring and all of the keypad LEDs to make sure that the LEDs operate correctly. <b>Note:</b> A damaged LED Status Ring board will prevent an accurate estimate of the internal status of the drive. Do not use only the LED Status Ring to estimate the status of the drive and motors. 1. Set <i>o2-24 = 0 [LED Light Function Selection = Enable Status Ring &amp; Keypad LED]</i>. 2. Push  with <i>U4-09</i> shown on the keypad. All LEDs on the keypad and LED Status Ring will turn on. <b>Note:</b> When Safety input 2 CH is open (STo), READY will flash.</p>	No signal output available	-
U4-10 (005C)	kWh, Lower 4 Digits	<p><b>V/f</b> <b>CL-V/f</b> <b>OLV</b> <b>CLV</b> <b>AOLV</b> <b>OLV/PM</b> <b>AOLV/PM</b> <b>CLV/PM</b> <b>EZOLV</b></p> <p>Displays the lower 4 digits of the watt hour value for the drive. Unit: 1 kWh <b>Note:</b> The watt hour is displayed in 9 digits. Parameter <i>U4-11 [kWh, Upper 5 Digits]</i> displays the upper 5 digits and <i>U4-10</i> displays the lower 4 digits. Example for 12345678.9 kWh: <i>U4-10</i>: 678.9 kWh <i>U4-11</i>: 12345 MWh</p>	No signal output available	-
U4-11 (005D)	kWh, Upper 5 Digits	<p><b>V/f</b> <b>CL-V/f</b> <b>OLV</b> <b>CLV</b> <b>AOLV</b> <b>OLV/PM</b> <b>AOLV/PM</b> <b>CLV/PM</b> <b>EZOLV</b></p> <p>Shows the upper 5 digits of the watt hour value for the drive. Unit: 1 MWh <b>Note:</b> Monitor <i>U4-11</i> shows the upper 5 digits and <i>U4-10 [kWh, Lower 4 Digits]</i> shows the lower 4 digits. Example for 12345678.9 kWh: <i>U4-10</i>: 678.9 kWh <i>U4-11</i>: 12345 MWh</p>	No signal output available	-
U4-13 (07CF)	Peak Hold Current	<p><b>V/f</b> <b>CL-V/f</b> <b>OLV</b> <b>CLV</b> <b>AOLV</b> <b>OLV/PM</b> <b>AOLV/PM</b> <b>CLV/PM</b> <b>EZOLV</b></p> <p>Shows the hold value of the peak value (rms) for the drive output current. Use <i>U4-14 [PeakHold Output Freq]</i> to show the drive output frequency at the time that the drive holds the output current. The drive will hold the peak hold current at the next start up and restart of the power supply. The drive keeps the held value during baseblock (during stop). The keypad shows the value of <i>U4-13</i> in amperes (A). When looking at the monitor through MEMOBUS/Modbus communications, the current is “8192 = drive rated current (A).” Calculate the current from the monitor value that is in at MEMOBUS/Modbus communications using “Numerals being displayed / 8192 × drive rated current (A).” Unit: Determined by the drive model. • 0.01 A: 2004 to 2042, 4002 to 4023 • 0.1 A: 2056 to 2415, 4031 to 4675</p>	No signal output available	-

No. (Hex.)	Name	Description	MFAO Signal Level	Ref.
U4-14 (07D0)	PeakHold Output Freq	<p><b>V/f</b> <b>CL-V/f</b> <b>OLV</b> <b>CLV</b> <b>AOLV</b> <b>OLV/PM</b> <b>AOLV/PM</b> <b>CLV/PM</b> <b>EZOLV</b></p> <p>Displays the output frequency at which the peak value (rms) of the drive output current is held.</p> <p>The peak hold current can be monitored by <i>U4-13 [Peak Hold Current]</i>.</p> <p>The peak hold output frequency will be cleared at the next startup and restart of the power supply. The drive keeps the value that was under hold during baseblock (during stop).</p> <p>Unit: 0.01 Hz</p>	No signal output available	-
U4-16 (07D8)	Motor oL1 Level	<p><b>V/f</b> <b>CL-V/f</b> <b>OLV</b> <b>CLV</b> <b>AOLV</b> <b>OLV/PM</b> <b>AOLV/PM</b> <b>CLV/PM</b> <b>EZOLV</b></p> <p>Shows the integrated value of <i>oL1 [Motor Overload]</i> as a percentage of <i>oL1</i> detection level.</p> <p>Unit: 0.1%</p>	10 V: 100%	-
U4-18 (07DA)	Reference Source	<p><b>V/f</b> <b>CL-V/f</b> <b>OLV</b> <b>CLV</b> <b>AOLV</b> <b>OLV/PM</b> <b>AOLV/PM</b> <b>CLV/PM</b> <b>EZOLV</b></p> <p>Shows the selected frequency reference source.</p> <p>The keypad shows the frequency reference source as "XY-<i>nn</i>" as specified by these rules:</p> <p>X: <i>External Reference 1/2 Selection [H1-xx = 2]</i> selection status</p> <ul style="list-style-type: none"> <li>• 1: <i>b1-01 [Frequency Reference Selection 1]</i></li> <li>• 2: <i>b1-15 [Frequency Reference Selection 2]</i></li> </ul> <p>Y-<i>nn</i>: Frequency reference source</p> <ul style="list-style-type: none"> <li>• 0-01: Keypad (<i>d1-01 [Reference 1]</i>)</li> <li>• 1-00: Analog input (unassigned)</li> <li>• 1-01: MFAI terminal A1</li> <li>• 1-02: MFAI terminal A2</li> <li>• 1-03: MFAI terminal A3</li> <li>• 2-02 to 2-17: Multi-step speed reference (<i>d1-02 to d1-17 [Reference 2 to 16, Jog Reference]</i>)</li> <li>• 3-01: MEMOBUS/Modbus communications</li> <li>• 4-01: Communication option card</li> <li>• 5-01: Pulse train input</li> <li>• 7-01: DriveWorksEZ</li> <li>• 9-01: Up/Down command</li> </ul>	No signal output available	-
U4-19 (07DB)	Modbus FreqRef (dec)	<p><b>V/f</b> <b>CL-V/f</b> <b>OLV</b> <b>CLV</b> <b>AOLV</b> <b>OLV/PM</b> <b>AOLV/PM</b> <b>CLV/PM</b> <b>EZOLV</b></p> <p>Shows the frequency reference sent to the drive from the MEMOBUS/Modbus communications as a decimal.</p> <p>Unit: 0.01%</p>	No signal output available	-
U4-20 (07DC)	Option Freq Ref (dec)	<p><b>V/f</b> <b>CL-V/f</b> <b>OLV</b> <b>CLV</b> <b>AOLV</b> <b>OLV/PM</b> <b>AOLV/PM</b> <b>CLV/PM</b> <b>EZOLV</b></p> <p>Shows the frequency reference sent to the drive from the communication option as a decimal.</p>	No signal output available	-

No. (Hex.)	Name	Description	MFAO Signal Level	Ref.
U4-21 (07DD)	Run Command Source	<p><b>V/f</b> <b>CL-V/f</b> <b>OLV</b> <b>CLV</b> <b>AOLV</b> <b>OLV/PM</b> <b>AOLV/PM</b> <b>CLV/PM</b> <b>EZOLV</b></p> <p>Shows the selected Run command source.                      The keypad shows the Run command source as "XY-nn" as specified by these rules:                      X: <i>External Reference 1/2 Selection [HI-xx = 2]</i> selection status                      • 1: <i>b1-02 [Run Command Selection 1]</i>                      • 2: <i>b1-16 [Run Command Selection 2]</i>                      Y: Run command source                      • 0: Keypad                      • 1: Control circuit terminal                      • 3: MEMOBUS/Modbus communications                      • 4: Communication option card                      • 7: DriveWorksEZ                      nn: Run command limit status data                      • 00: No limit status.                      • 01: The Run command was left ON when the drive stopped in the Programming Mode.                      • 02: The Run command was left ON when switching from LOCAL Mode to REMOTE Mode.                      • 03: The Run command is in standby after the drive was energized until the soft charge bypass contactor turns ON.  <b>Note:</b>                      The drive will detect <i>Uv1 [DC Bus Undervoltage]</i> or <i>Uv [Undervoltage]</i> if the soft charge bypass contactor does not turn ON after 10 s.                      • 04: Restart after run stop is prohibited.                      • 05: Fast stop has been executed using the MFDI terminal. Or, the motor has ramped to stop by pressing the STOP key on the keypad.                      • 06: <i>b1-17 = 0 [Run Command at Power Up = Disregard Existing RUN Command]</i> is set.                      • 07: During baseblock while coast to stop with timer.                      • 08: Frequency reference is below <i>E1-09 [Minimum Output Frequency]</i> during baseblock.                      • 09: Waiting for the Enter command from PLC.</p>	No signal output The keypad shows the Run command source as "XY-nn" as specified by these rules: available	-
U4-22 (07DE)	Modbus CmdData (hex)	<p><b>V/f</b> <b>CL-V/f</b> <b>OLV</b> <b>CLV</b> <b>AOLV</b> <b>OLV/PM</b> <b>AOLV/PM</b> <b>CLV/PM</b> <b>EZOLV</b></p> <p>Shows the operation signal (register 0001H) sent to the drive from MEMOBUS/Modbus communications as a 4-digit hexadecimal number (zero suppress). The keypad shows the operation signal as specified by these rules:                      bit 0 : Forward run/Stop                      bit 1 : Reverse run/Stop                      bit 2 : External fault                      bit 3 : Fault Reset                      bit 4 : Multi-function input 1                      bit 5 : Multi-function input 2                      bit 6 : Multi-function input 3                      bit 7 : Multi-function input 4                      bit 8 : Multi-function input 5                      bit 9 : Multi-function input 6                      bit A : Multi-function input 7                      bit B : Multi-function input 8                      bit C : Not used (normal value of 0).                      bit D : Not used (normal value of 0).                      bit E : Not used (normal value of 0).                      bit F : Not used (normal value of 0).</p>	No signal output available	-



No. (Hex.)	Name	Description	MFAO Signal Level	Ref.
U4-23 (07DF)	Option CmdData (hex)	<p><b>V/f</b> <b>CL-V/f</b> <b>OLV</b> <b>CLV</b> <b>AOLV</b> <b>OLV/PM</b> <b>AOLV/PM</b> <b>CLV/PM</b> <b>EZOLV</b></p> <p>Shows the operation signal (register 0001H) sent to the drive from MEMOBUS/Modbus communications as a 4-digit hexadecimal number. The keypad shows the operation signal as specified by these rules:</p> <p>bit 0 : Forward run/Stop  bit 1 : Reverse run/Stop  bit 2 : External fault  bit 3 : Fault Reset  bit 4 : Multi-function input 1  bit 5 : Multi-function input 2  bit 6 : Multi-function input 3  bit 7 : Multi-function input 4  bit 8 : Multi-function input 5  bit 9 : Multi-function input 6  bit A : Multi-function input 7  bit B : Multi-function input 8  bit C : Not used (normal value of 0).  bit D : Not used (normal value of 0).  bit E : Not used (normal value of 0).  bit F : Not used (normal value of 0).</p>	No signal output available	-
U4-24 (07E6)	Number of Runs (Low)	<p><b>V/f</b> <b>CL-V/f</b> <b>OLV</b> <b>CLV</b> <b>AOLV</b> <b>OLV/PM</b> <b>AOLV/PM</b> <b>CLV/PM</b> <b>EZOLV</b></p> <p>Shows the lower 4 digits of the drive run count.</p> <p><b>Note:</b>  The drive run count appears as an 8-digit number. The upper 4 digits of U4-25 [Number of Runs(High)] and the lower 4 digits of U4-24 appears.</p>	No signal output available	-
U4-25 (07E7)	Number of Runs (High)	<p><b>V/f</b> <b>CL-V/f</b> <b>OLV</b> <b>CLV</b> <b>AOLV</b> <b>OLV/PM</b> <b>AOLV/PM</b> <b>CLV/PM</b> <b>EZOLV</b></p> <p>Shows the lower 4 digits of the drive run count.</p> <p><b>Note:</b>  The keypad shows the drive run count in 8 digits. Monitor U4-25 shows the upper 4 digits and U4-24 [Number of Runs (Low)] shows the lower 4 digits.</p>	No signal output available	-
U4-52 (1592)	Torque Ref from Comm	<p><b>V/f</b> <b>CL-V/f</b> <b>OLV</b> <b>CLV</b> <b>AOLV</b> <b>OLV/PM</b> <b>AOLV/PM</b> <b>CLV/PM</b> <b>EZOLV</b></p> <p>Displays the torque reference given to the drive via a serial communication option card or via MEMOBUS/Modbus communications as a decimal number.</p> <p>Unit: 0.1%</p>	No signal output available	-

## ◆ U5: PID Monitors

No. (Hex.)	Name	Description	MFAO Signal Level	Ref.
U5-01 (0057)	PID Feedback	<p><b>V/f</b> <b>CL-V/f</b> <b>OLV</b> <b>CLV</b> <b>AOLV</b> <b>OLV/PM</b> <b>AOLV/PM</b> <b>CLV/PM</b> <b>EZOLV</b></p> <p>Shows the PID control feedback value. Parameter b5-20 [PID Unit Selection] sets the display units.</p> <p>Unit: 0.01%</p>	10 V: Maximum frequency (-10 V to +10 V)	-
U5-02 (0063)	PID Input	<p><b>V/f</b> <b>CL-V/f</b> <b>OLV</b> <b>CLV</b> <b>AOLV</b> <b>OLV/PM</b> <b>AOLV/PM</b> <b>CLV/PM</b> <b>EZOLV</b></p> <p>Shows the change between the PID setpoint and PID feedback (the quantity of PID input) as a percentage of the maximum output frequency.</p> <p>Unit: 0.01%</p>	10 V: Maximum frequency (-10 V to +10 V)	-
U5-03 (0064)	PID Output	<p><b>V/f</b> <b>CL-V/f</b> <b>OLV</b> <b>CLV</b> <b>AOLV</b> <b>OLV/PM</b> <b>AOLV/PM</b> <b>CLV/PM</b> <b>EZOLV</b></p> <p>Shows the PID control output as a percentage of the maximum output frequency.</p> <p>Unit: 0.01%</p>	10 V: Maximum frequency (-10 V to +10 V)	-
U5-04 (0065)	PID Setpoint	<p><b>V/f</b> <b>CL-V/f</b> <b>OLV</b> <b>CLV</b> <b>AOLV</b> <b>OLV/PM</b> <b>AOLV/PM</b> <b>CLV/PM</b> <b>EZOLV</b></p> <p>Shows the PID setpoint. Parameter b5-20 [PID Unit Selection] sets the display units.</p> <p>Unit: 0.01%</p>	10 V: Maximum frequency (-10 V to +10 V)	-

No. (Hex.)	Name	Description	MFAO Signal Level	Ref.
U5-05 (07D2)	PID DifferentialFdbk	<p><b>V/f</b> <b>CL-V/f</b> <b>OLV</b> <b>CLV</b> <b>AOLV</b> <b>OLV/PM</b> <b>AOLV/PM</b> <b>CLV/PM</b> <b>EZOLV</b></p> <p>Shows the PID differential feedback value as a percentage of the maximum output frequency. This monitor is available after setting H3-02, H3-10, or H3-06 = 16 [MFAI Function Select = Differential PID Feedback]. Unit: 0.01%</p>	10 V: Maximum frequency (-10 V to +10 V)	-
U5-06 (07D3)	PID Fdbk-Diff PID Fdbk	<p><b>V/f</b> <b>CL-V/f</b> <b>OLV</b> <b>CLV</b> <b>AOLV</b> <b>OLV/PM</b> <b>AOLV/PM</b> <b>CLV/PM</b> <b>EZOLV</b></p> <p>Shows the difference from calculating U5-05 - U5-01 [PID DifferentialFdbk] - [PID Feedback]. Unit: 0.01%</p> <p><b>Note:</b> U5-01 = U5-06 when H3-02, H3-10, or H3-06 ≠ 16 [MFAI Function Select ≠ Differential PID Feedback].</p>	10 V: Maximum frequency (-10 V to +10 V)	-
U5-21 (0872) Expert	Energy Save Coeff Ki	<p><b>V/f</b> <b>CL-V/f</b> <b>OLV</b> <b>CLV</b> <b>AOLV</b> <b>OLV/PM</b> <b>AOLV/PM</b> <b>CLV/PM</b> <b>EZOLV</b></p> <p>Shows the energy-saving coefficient Ki value for PM. Unit: 0.01</p>	No signal output available	-
U5-22 (0873) Expert	Energy Save Coeff Kt	<p><b>V/f</b> <b>CL-V/f</b> <b>OLV</b> <b>CLV</b> <b>AOLV</b> <b>OLV/PM</b> <b>AOLV/PM</b> <b>CLV/PM</b> <b>EZOLV</b></p> <p>Shows the energy-saving coefficient Kt value for PM. Unit: 0.01</p>	No signal output available	-
U5-99 (1599)	PID Setpoint Command	<p><b>V/f</b> <b>CL-V/f</b> <b>OLV</b> <b>CLV</b> <b>AOLV</b> <b>OLV/PM</b> <b>AOLV/PM</b> <b>CLV/PM</b> <b>EZOLV</b></p> <p>Shows the PID setpoint command. Parameter b5-20 [PID Unit Selection] sets display units. Unit: 0.01%</p>	10 V: Maximum frequency (-10 V to +10 V)	-

◆ U6: Operation Status Monitors

No. (Hex.)	Name	Description	MFAO Signal Level	Ref.
U6-01 (0051)	Iq Secondary Current	<p><b>V/f</b> <b>CL-V/f</b> <b>OLV</b> <b>CLV</b> <b>AOLV</b> <b>OLV/PM</b> <b>AOLV/PM</b> <b>CLV/PM</b> <b>EZOLV</b></p> <p>Shows the value calculated for the motor secondary current as a percentage of the motor rated secondary current. (q axis) Unit: 0.1%</p>	10 V: Motor secondary rated current (-10 V to +10 V)	-
U6-02 (0052)	Id ExcitationCurrent	<p><b>V/f</b> <b>CL-V/f</b> <b>OLV</b> <b>CLV</b> <b>AOLV</b> <b>OLV/PM</b> <b>AOLV/PM</b> <b>CLV/PM</b> <b>EZOLV</b></p> <p>Shows the value calculated for the motor excitation current as a percentage of the motor rated secondary current. (d axis) Unit: 0.1%</p>	10 V: Motor secondary rated current (-10 V to +10 V)	-
U6-03 (0054)	ASR Input	<p><b>V/f</b> <b>CL-V/f</b> <b>OLV</b> <b>CLV</b> <b>AOLV</b> <b>OLV/PM</b> <b>AOLV/PM</b> <b>CLV/PM</b> <b>EZOLV</b></p> <p>Shows the ASR input value as a percentage of the maximum frequency. Unit: 0.01%</p>	10 V: Maximum frequency (-10 V to +10 V)	-
U6-04 (0055)	ASR Output	<p><b>V/f</b> <b>CL-V/f</b> <b>OLV</b> <b>CLV</b> <b>AOLV</b> <b>OLV/PM</b> <b>AOLV/PM</b> <b>CLV/PM</b> <b>EZOLV</b></p> <p>Shows the ASR output value as a percentage of the motor rated secondary current. Unit: 0.01%</p>	10 V: Motor secondary rated current (-10 V to +10 V)	-
U6-05 (0059)	OutputVoltageRef: Vq	<p><b>V/f</b> <b>CL-V/f</b> <b>OLV</b> <b>CLV</b> <b>AOLV</b> <b>OLV/PM</b> <b>AOLV/PM</b> <b>CLV/PM</b> <b>EZOLV</b></p> <p>Shows the drive internal voltage reference for motor secondary current control. (q axis) Unit: 0.1 V</p>	200 V class: 10 V = 200 Vrms 400 V class: 10 V = 400 Vrms (-10 V to +10 V)	-
U6-06 (005A)	OutputVoltageRef: Vd	<p><b>V/f</b> <b>CL-V/f</b> <b>OLV</b> <b>CLV</b> <b>AOLV</b> <b>OLV/PM</b> <b>AOLV/PM</b> <b>CLV/PM</b> <b>EZOLV</b></p> <p>Shows the drive internal voltage reference for motor excitation current control. (d axis) Unit: 0.1 V</p>	200 V class: 10 V = 200 Vrms 400 V class: 10 V = 400 Vrms (-10 V to +10 V)	-

No. (Hex.)	Name	Description	MFAO Signal Level	Ref.
U6-07 (005F) Expert	q-Axis ACR Output	<input type="checkbox"/> V/f <input type="checkbox"/> CL-V/f <input checked="" type="checkbox"/> OLV <input checked="" type="checkbox"/> CLV <input type="checkbox"/> AOLV <input type="checkbox"/> OLV/PM <input type="checkbox"/> AOLV/PM <input type="checkbox"/> CLV/PM <input type="checkbox"/> EZOLV Shows the output value for current control related to motor secondary current. (q axis) Unit: 0.1%	200 V class: 10 V = 200 Vrms 400 V class: 10 V = 400 Vrms (-10 V to +10 V)	-
U6-08 (0060) Expert	d-Axis ACR Output	<input type="checkbox"/> V/f <input type="checkbox"/> CL-V/f <input checked="" type="checkbox"/> OLV <input checked="" type="checkbox"/> CLV <input type="checkbox"/> AOLV <input type="checkbox"/> OLV/PM <input type="checkbox"/> AOLV/PM <input type="checkbox"/> CLV/PM <input type="checkbox"/> EZOLV Shows the output value for current control related to motor excitation current. (d axis) Unit: 0.1%	200 V class: 10 V = 200 Vrms 400 V class: 10 V = 400 Vrms (-10 V to +10 V)	-
U6-09 (07C0) Expert	AdvPhase Compen $\Delta\theta$	<input type="checkbox"/> V/f <input type="checkbox"/> CL-V/f <input type="checkbox"/> OLV <input type="checkbox"/> CLV <input type="checkbox"/> AOLV <input type="checkbox"/> OLV/PM <input checked="" type="checkbox"/> AOLV/PM <input type="checkbox"/> CLV/PM <input type="checkbox"/> EZOLV Displays the data on forward phase compensation for the calculation results of the amount of control axis deviation. Unit: 1 °	10 V: 180° (-10 V to +10 V)	-
U6-10 (07C1) Expert	ContAxisDeviation $\Delta\theta$	<input type="checkbox"/> V/f <input type="checkbox"/> CL-V/f <input type="checkbox"/> OLV <input type="checkbox"/> CLV <input type="checkbox"/> AOLV <input type="checkbox"/> OLV/PM <input checked="" type="checkbox"/> AOLV/PM <input type="checkbox"/> CLV/PM <input type="checkbox"/> EZOLV Shows the deviation between the $\gamma\delta$ -Axis used for motor control and the dq-Axis. Unit: 0.1 °	10 V: 180° (-10 V to +10 V)	-
U6-13 (07CA) Expert	MagPolePosition (Enc)	<input type="checkbox"/> V/f <input type="checkbox"/> CL-V/f <input type="checkbox"/> OLV <input type="checkbox"/> CLV <input type="checkbox"/> AOLV <input type="checkbox"/> OLV/PM <input type="checkbox"/> AOLV/PM <input checked="" type="checkbox"/> CLV/PM <input type="checkbox"/> EZOLV Shows the value of the flux position detection. Unit: 0.1 °	10 V: 180° (-10 V to +10 V)	-
U6-14 (07CB) Expert	MagPolePosition (Obs)	<input type="checkbox"/> V/f <input type="checkbox"/> CL-V/f <input type="checkbox"/> OLV <input type="checkbox"/> CLV <input type="checkbox"/> AOLV <input checked="" type="checkbox"/> OLV/PM <input checked="" type="checkbox"/> AOLV/PM <input type="checkbox"/> CLV/PM <input type="checkbox"/> EZOLV Shows the value of the flux position estimation. Unit: 0.1 °	10 V: 180° (-10 V to +10 V)	-
U6-17 (07D1) Expert	Energy Save Coeff	<input checked="" type="checkbox"/> V/f <input type="checkbox"/> CL-V/f <input type="checkbox"/> OLV <input type="checkbox"/> CLV <input type="checkbox"/> AOLV <input type="checkbox"/> OLV/PM <input type="checkbox"/> AOLV/PM <input type="checkbox"/> CLV/PM <input type="checkbox"/> EZOLV Shows the total time of direction of motor rotation detections for Speed Estimation Speed Searches. This value adjusts <i>b3-26 [Direction Determination Level]</i> . <b>Note:</b> Upper limit is +32767 and lower limit is -32767.	No signal output available	-
U6-18 (07CD)	Enc 1 Pulse Counter	<input type="checkbox"/> V/f <input type="checkbox"/> CL-V/f <input type="checkbox"/> OLV <input type="checkbox"/> CLV <input type="checkbox"/> AOLV <input type="checkbox"/> OLV/PM <input type="checkbox"/> AOLV/PM <input type="checkbox"/> CLV/PM <input type="checkbox"/> EZOLV Shows the number of pulses for speed detection (PG1). Unit: 1 pulse	10 V: 65536	-
U6-19 (07E5)	Enc 2 Pulse Counter	<input type="checkbox"/> V/f <input type="checkbox"/> CL-V/f <input type="checkbox"/> OLV <input type="checkbox"/> CLV <input type="checkbox"/> AOLV <input type="checkbox"/> OLV/PM <input type="checkbox"/> AOLV/PM <input type="checkbox"/> CLV/PM <input type="checkbox"/> EZOLV Shows the number of pulses for speed detection (PG2). Unit: 1 pulse	10 V: 65536	-
U6-20 (07D4)	UP/DOWN 2 Bias Value	<input type="checkbox"/> V/f <input type="checkbox"/> CL-V/f <input type="checkbox"/> OLV <input type="checkbox"/> CLV <input type="checkbox"/> AOLV <input type="checkbox"/> OLV/PM <input type="checkbox"/> AOLV/PM <input type="checkbox"/> CLV/PM <input type="checkbox"/> EZOLV Shows the bias value used to adjust the frequency reference. Unit: 0.1%	10 V: Maximum Frequency	-
U6-21 (07D5)	Offset Frequency	<input type="checkbox"/> V/f <input type="checkbox"/> CL-V/f <input type="checkbox"/> OLV <input type="checkbox"/> CLV <input type="checkbox"/> AOLV <input type="checkbox"/> OLV/PM <input type="checkbox"/> AOLV/PM <input type="checkbox"/> CLV/PM <input type="checkbox"/> EZOLV Shows the total value of <i>d7-01 to d7-03 [Offset Frequency 1 to 3]</i> selected with <i>Add Offset Frequency 1 to 3 [H1-xx = 44 to 46]</i> . Unit: 0.1%	10 V: Maximum Frequency	-
U6-22 (0062)	ZeroServo Pulse Move	<input type="checkbox"/> V/f <input type="checkbox"/> CL-V/f <input type="checkbox"/> OLV <input checked="" type="checkbox"/> CLV <input type="checkbox"/> AOLV <input type="checkbox"/> OLV/PM <input type="checkbox"/> AOLV/PM <input type="checkbox"/> CLV/PM <input type="checkbox"/> EZOLV Shows the distance that the rotor moved from its last position when Zero Servo is available. The value shown in this monitor = 4 X [No. of PG pulses]. Unit: 1 pulse	10 V: Number of pulses per revolution (-10 V to +10 V)	-
U6-25 (006B) Expert	ASR Output Level	<input type="checkbox"/> V/f <input type="checkbox"/> CL-V/f <input type="checkbox"/> OLV <input checked="" type="checkbox"/> CLV <input type="checkbox"/> AOLV <input type="checkbox"/> OLV/PM <input type="checkbox"/> AOLV/PM <input type="checkbox"/> CLV/PM <input type="checkbox"/> EZOLV Shows the primary delay filter input value of the ASR (speed control loop). Unit: 0.01%	10 V: Motor secondary rated current (-10 V to +10 V)	-
U6-26 (006C) Expert	Feed Fwd Cont Output	<input type="checkbox"/> V/f <input type="checkbox"/> CL-V/f <input type="checkbox"/> OLV <input checked="" type="checkbox"/> CLV <input type="checkbox"/> AOLV <input type="checkbox"/> OLV/PM <input type="checkbox"/> AOLV/PM <input type="checkbox"/> CLV/PM <input type="checkbox"/> EZOLV Shows the Feed Forward control output. Unit: 0.01%	10 V: Motor secondary rated current (-10 V to +10 V)	-

No. (Hex.)	Name	Description	MFAO Signal Level	Ref.
U6-27 (006D) Expert	FeedFwd Estimate Spd	 Shows the feed forward estimated speed. Unit: 0.01%	10 V = Maximum frequency (-10 V to +10 V)	-
U6-31 (007B)	TorqueDetect Monitor	 Monitors the torque reference or the output current after applying the filter set to L6-07 [Torque Detection Filter Time]. Unit: 0.1%	10 V:100%	-
U6-36 (0720) Expert	Comm Errors-Host	 Shows the number of inter-CPU communication errors. De-energizing the drive sets this number to 0.	No signal output available	-
U6-37 (0721) Expert	Comm Errors-Sensor	 Shows the number of inter-CPU communication errors. De-energizing the drive sets this number to 0.	No signal output available	-
U6-48 (072E) Expert	ASIC Comm Errors	 Counts the number of inter-ASIC communication errors detected by the ASIC. This count is reset to 0 when the power to the drive is turned off.	No signal output available	-
U6-57 (07C4)	PolePolarityDeterVal	 Shows the change from the integrated current when finding the polarity. Unit: 1 <b>Note:</b> If the change from the integrated current is less than 819, increase n8-84 [Polarity Detection Current]. U6-57 = 8192 is equivalent to the motor rated current.	No signal output available	-
U6-80 to U6-83 (07B0 to 07B3)	Option IP Address 1 to 4	 Shows the currently available local IP Address. • U6-80: 1st octet • U6-81: 2nd octet • U6-82: 3rd octet • U6-83: 4th octet	No signal output available	-
U6-84 to U6-87 (07B4 to 07B7)	Online Subnets 1 to 4	 Shows the currently available subnet mask. • U6-84: 1st octet • U6-85: 2nd octet • U6-86: 3rd octet • U6-87: 4th octet	No signal output available	-
U6-88 to U6-91 (07B8, 07B9, 07F0, 07F1)	Online Gateways 1 to 4	 Shows the currently available gateway address. • U6-88: 1st octet • U6-89: 2nd octet • U6-90: 3rd octet • U6-91: 4th octet	No signal output available	-
U6-92 (07F2)	Online Speed	 Shows the currently available communications speed. 10: 10 Mbps 100: 100 Mbps	No signal output available	-
U6-93 (07F3)	Online Duplex	 Shows the currently available Duplex setting.	No signal output available	-
U6-98 (07F8)	First Fault	 Shows the contents of the most recent communication options fault (DeviceNet, Modbus TCP/IP, EtherNet/IP).	No signal output available	-
U6-99 (07F9)	Current Fault	 Shows the contents of current fault from communication options (DeviceNet, Modbus TCP/IP, EtherNet/IP).	No signal output available	-

## ◆ U8: DriveWorksEZ Monitors

No. (Hex.)	Name	Description	MFAO Signal Level	Ref.
U8-01 to U8-10 (1950 - 1959)	DWEZ Monitors 1 to 10	<div style="display: flex; justify-content: space-between; gap: 5px;"> <span>V/f</span> <span>CL-V/f</span> <span>OLV</span> <span>CLV</span> <span>AOLV</span> <span>OLV/PM</span> <span>AOLV/PM</span> <span>CLV/PM</span> <span>EZOLV</span> </div> Shows DriveWorks EZ Monitors 1 to 10. Unit: 0.01%	10 V = 100%	-
U8-11 to U8-13 (195A - 195C)	DWEZ Versions 1 to 3	<div style="display: flex; justify-content: space-between; gap: 5px;"> <span>V/f</span> <span>CL-V/f</span> <span>OLV</span> <span>CLV</span> <span>AOLV</span> <span>OLV/PM</span> <span>AOLV/PM</span> <span>CLV/PM</span> <span>EZOLV</span> </div> Shows DriveWorks EZ Versions 1 to 3.	No signal output available	-
U8-18 (1961)	DWEZ Platform Ver	<div style="display: flex; justify-content: space-between; gap: 5px;"> <span>V/f</span> <span>CL-V/f</span> <span>OLV</span> <span>CLV</span> <span>AOLV</span> <span>OLV/PM</span> <span>AOLV/PM</span> <span>CLV/PM</span> <span>EZOLV</span> </div> Shows the DriveWorksEZ platform version.	No signal output available	-
U8-21 to U8-25 (1964 - 1968)	DWEZ Monitors 21 to 25	<div style="display: flex; justify-content: space-between; gap: 5px;"> <span>V/f</span> <span>CL-V/f</span> <span>OLV</span> <span>CLV</span> <span>AOLV</span> <span>OLV/PM</span> <span>AOLV/PM</span> <span>CLV/PM</span> <span>EZOLV</span> </div> Shows DriveWorksEZ User Monitors 21 to 25. 0.01%	10 V = 100%	-
U8-31 to U8-40 (196E - 1977)	DWEZ Monitors 31 to 40	<div style="display: flex; justify-content: space-between; gap: 5px;"> <span>V/f</span> <span>CL-V/f</span> <span>OLV</span> <span>CLV</span> <span>AOLV</span> <span>OLV/PM</span> <span>AOLV/PM</span> <span>CLV/PM</span> <span>EZOLV</span> </div> Shows DriveWorksEZ User Monitors 31 to 40. 0.01%	10 V = 100%	-
U8-51 to U8-55 (1982 - 1986)	DWEZ Monitors 51 to 55	<div style="display: flex; justify-content: space-between; gap: 5px;"> <span>V/f</span> <span>CL-V/f</span> <span>OLV</span> <span>CLV</span> <span>AOLV</span> <span>OLV/PM</span> <span>AOLV/PM</span> <span>CLV/PM</span> <span>EZOLV</span> </div> Shows DriveWorksEZ User Monitors 51 to 55. 0.01%	10 V = 100%	-

## 10.18 Parameters that Change from the Default Settings with A1-02 [Control Method Selection]

The values for the parameters in these tables depend on the values for parameter *A1-02*. Changing the setting for *A1-02* will change the default settings.

### ◆ A1-02 = 0 to 4 [Induction Motor Control Methods]

No.	Name	Setting Range	Unit	Control Method (A1-02 Setting)				
				V/f (0)	CL-V/f (1)	OLV (2)	CLV (3)	AOLV (4)
b2-01	DC Injection/Zero SpeedThresh hold	0.0 - 10.0	0.1 Hz	0.5	0.5	0.5	0.5	0.5
b2-04	DC Inject Braking Time at Stop	0.00 - 10.00	0.01 s	0.50	0.50	0.50	0.50	0.50
b3-01	Speed Search at Start Selection	0 - 1	1	0	1	0	1	0
b3-14	Bi-directional Speed Search	0 - 1	1	1	0	1	1	1
b5-15	PID Sleep Function Start Level	0.0 - 400.0	0.1 Hz	0.0	0.0	0.0	0.0	0.0
b6-01	Dwell Reference at Start	0.0 - 400.0	0.1 Hz	0.0	0.0	0.0	0.0	0.0
b6-03	Dwell Reference at Stop	0.0 - 400.0	0.1 Hz	0.0	0.0	0.0	0.0	0.0
b8-02	Energy Saving Gain	0.0 - 10.0	0.1	-	-	0.7	1.0	1.0
b8-03	Energy Saving Filter Time	0.00 - 10.00	0.01 s	-	-	0.50 *1	0.01 *1	0.01 *1
C1-11	Accel/Decel Time Switchover Freq	0.0 - 400.0	0.1 Hz	0.0	0.0	0.0	0.0	0.0
C2-01	S-Curve Time @ Start of Accel	0.00 - 10.00	0.01 s	0.20	0.20	0.20	0.20	0.20
C3-01	Slip Compensation Gain	0.0 - 2.5	0.1	0.0	-	1.0	1.0	0.1
C3-02	Slip Compensation Delay Time	0 - 10000	1 ms	2000	-	200	-	-
C4-01	Torque Compensation Gain	0.00 - 2.50	0.01	1.00	1.00	1.00	-	-
C4-02	Torque Compensation Delay Time	0 - 10000	1 ms	200 *2	200 *2	20	-	-
C5-01	ASR Proportional Gain 1	0.00 - 300.00	0.01	-	0.20	-	20.00	10.00

10.18 Parameters that Change from the Default Settings with A1-02 [Control Method Selection]

No.	Name	Setting Range	Unit	Control Method (A1-02 Setting)				
				V/f (0)	CL-V/f (1)	OLV (2)	CLV (3)	AOLV (4)
C5-02	ASR Integral Time 1	0.000 - 60.000	0.001 s	-	0.200	-	0.500	0.500
C5-03	ASR Proportional Gain 2	0.00 - 300.00	0.01	-	0.02	-	20.00	10.00
C5-04	ASR Integral Time 2	0.000 - 10.000	0.001 s	-	0.050	-	0.500	0.500
C5-06	ASR Delay Time	0.000 - 0.500	0.001 s	-	-	-	0.004	0.004
C5-07	ASR Gain Switchover Frequency	0.0 - 400.0	0.1 Hz	0.0	0.0	0.0	0.0	0.0
C6-02	Carrier Frequency Selection	1 - F	1	1 *3	1 *3	1 *3	1	1
d3-01	Jump Frequency 1	0.0 - 400.0	0.1 Hz	0.0	0.0	0.0	0.0	0.0
d3-02	Jump Frequency 2	0.0 - 400.0	0.1 Hz	0.0	0.0	0.0	0.0	0.0
d3-03	Jump Frequency 3	0.0 - 400.0	0.1 Hz	0.0	0.0	0.0	0.0	0.0
d3-04	Jump Frequency Width	0.0 - 20.0	0.1 Hz	1.0	1.0	1.0	1.0	1.0
d5-02	Torque Reference Delay Time	0 - 1000	1 ms	-	-	-	0	0
E1-04	Maximum Output Frequency	40.0 - 400.0 *3 *4	0.1 Hz	60.0 *5	60.0 *5	60.0	60.0	60.0
E1-05	Maximum Output Voltage	0.0 - 255.0 *6	0.1 V	200.0 *5	200.0 *5	200.0	200.0	200.0
E1-06	Base Frequency	0.0 - 400.0 *4	0.1 Hz	60.0 *5	60.0 *5	60.0	60.0	60.0
E1-07	Mid Point A Frequency	0.0 - 400.0 *4	0.1 Hz	3.0 *5	3.0 *5	3.0	0.0	3.0
E1-08	Mid Point A Voltage	0.0 - 255.0 *6	0.1 V	15.0 *5	15.0 *5	11.0	0.0	10.0
E1-09	Minimum Output Frequency	0.0 - 400.0 *4	0.1 Hz	1.5 *5	1.5 *5	0.5	0.0	0.6
E1-10	Minimum Output Voltage	0.0 - 255.0 *6	0.1 V	9.0 *5	9.0 *5	2.0	0.0	2.0
F1-01	Encoder 1 Pulse Count (PPR)	0 - 60000	1 ppr	600	600	600	600	600
F1-05	Encoder 1 Rotation Selection	0 - 1	1	0	0	0	0	0
F1-09	Overspeed Detection Delay Time	0.0 - 2.0	0.1 s	-	1.0	-	0.0	0.1
H4-20	Analog Power Monitor 100% Level	0.00 - 650.00	0.01	Default value of E2-11	Default value of E2-11	Determined by E2-11	Determined by E2-11	Determined by E2-11

## 10.18 Parameters that Change from the Default Settings with A1-02 [Control Method Selection]

No.	Name	Setting Range	Unit	Control Method (A1-02 Setting)				
				V/f (0)	CL-V/f (1)	OLV (2)	CLV (3)	AOLV (4)
L1-01	Motor Overload (oL1) Protection	0 - 4	1	1	1	1	1	1
L3-05	Stall Prevention during RUN	0 - 3	1	1	1	-	-	-
L3-20	DC Bus Voltage Adjustment Gain	0.00 - 5.00	0.01	1.00	1.00	0.30	0.30	0.30
L3-21	OVSUPPRESSION Accel/Decel P Gain	0.10 - 10.00	0.01	1.00	1.00	1.00	1.00	1.00
L3-36	Current Suppression Gain@Accel	0.0 - 100.0	0.1	10.0	10.0	20.0	-	-
L4-01	Speed Agree Detection Level	0.0 - 400.0 *7	0.1	0.0 Hz	0.0 Hz	0.0 Hz	0.0 Hz	0.0 Hz
L4-02	Speed Agree Detection Width	0.0 - 20.0	0.1	2.0 Hz	2.0 Hz	2.0 Hz	2.0 Hz	2.0 Hz
L4-03	Speed Agree Detection Level(+/-)	-400.0 - +400.0 *8	0.1	0.0 Hz	0.0 Hz	0.0 Hz	0.0 Hz	0.0 Hz
L4-04	Speed Agree Detection Width(+/-)	0.0 - 20.0	0.1	2.0 Hz	2.0 Hz	2.0 Hz	2.0 Hz	2.0 Hz
L8-38	Carrier Frequency Reduction	0 - 2	1	*3	*3	*3	*3	*3
L8-40	Carrier Freq Reduction Off-Delay	0.00 - 2.00	0.01 s	0.50	0.50	0.50	0.50	0.50
n1-15	PWM Voltage Offset Calibration	0 - 2	1	1	1	1	1	2
o1-03	Frequency Display Unit Selection	0 - 3	1	0	0	0	0	0
o1-04	V/f Pattern Display Unit	0 - 1	1	-	-	-	0	0

\*1 Drive models 2211 to 2415 and 4103 to 4675 use these default settings when C6-01 = 1 [Normal / Heavy Duty Selection = Normal Duty Rating]. Drive models 2257 to 2415, 4140 to 4675 use these default settings when C6-01 = 0 [Heavy Duty Rating].

- A1-02 = 2 [Open Loop Vector] : 2.00
- A1-02 = 3, 4 [Closed Loop Vector, Advanced Open Loop Vector] : 0.05

\*2 The default setting is 1000 ms for drive models 2110 to 2415 and 4103 to 4675.

\*3 The default setting varies depending on the setting of C6-01 [Normal / Heavy Duty Selection].

\*4 The setting range varies depending on the setting of E5-01 [PM Motor Code Selection] when A1-02 = 5 [Control Method Selection = PM Open Loop Vector].

\*5 The default setting varies depending on drive model and E1-03 [V/f Pattern Selection] settings.

\*6 This is the value for 200 V class drives. Double the value for 400 V class drives.

\*7 The maximum value within the setting range is 100.0 when A1-02 = 5 or 7 [Control Method Selection = PM Open Loop Vector or PM Closed Loop Vector].

\*8 The setting range is -100.0 to 100.0 when A1-02 = 5 or 7 [Control Method Selection = PM Open Loop Vector or PM Closed Loop Vector].



## ◆ A1-02 = 5 to 8 [Control Method for PM Motors and EZ Vector Control]

No.	Name	Setting Range	Unit	Control Method (A1-02 Setting)			
				OLV/PM (5)	AOLV/PM (6)	CLV/PM (7)	EZOLV (8)
b2-01	DC Injection/Zero SpeedThreshold	0.0 - 10.0	0.1	0.5 Hz	1.0%	0.5%	1.0%
b2-04	DC Inject Braking Time at Stop	0.00 - 10.00	0.01 s	0.00	0.00	0.00	0.00
b3-01	Speed Search at Start Selection	0 - 1	1	0	0	1	0
b3-14	Bi-directional Speed Search	0 - 1	1	1	1	1	1
b5-15	PID Sleep Function Start Level	0.0 - 400.0 *1	0.1	0.0 Hz	0.0 %	0.0 %	0.0 %
b6-01	Dwell Reference at Start	0.0 - 400.0 *1	0.1	0.0 Hz	0.0 %	0.0 %	0.0 %
b6-03	Dwell Reference at Stop	0.0 - 400.0 *1	0.1	0.0 Hz	0.0 %	0.0 %	0.0 %
b8-02	Energy Saving Gain	0.0 - 10.0	0.1	-	-	-	-
b8-03	Energy Saving Filter Time	0.00 - 10.00	0.01 s	-	-	-	-
C1-11	Accel/Decel Time Switchover Freq	0.0 - 400.0 *1	0.1	0.0 Hz	0.0 %	0.0 %	0.0 %
C2-01	S-Curve Time @ Start of Accel	0.00 - 10.00	0.01 s	1.00	0.20	0.20	1.00
C3-01	Slip Compensation Gain	0.0 - 2.5	0.1	-	-	-	Determined by E9-01
C3-02	Slip Compensation Delay Time	0 - 10000	1 ms	-	-	-	200
C4-01	Torque Compensation Gain	0.00 - 2.50	0.01	0.00	-	-	0.00
C4-02	Torque Compensation Delay Time	0 - 10000	1 ms	100	-	-	100
C5-01	ASR Proportional Gain 1	0.00 - 300.00	0.01	10.00	10.00	20.00	10.00
C5-02	ASR Integral Time 1	0.000 - 60.000	0.001 s	0.500	0.500	0.500	0.500
C5-03	ASR Proportional Gain 2	0.00 - 300.00	0.01	-	10.00	20.00	10.00
C5-04	ASR Integral Time 2	0.000 - 10.000	0.001 s	-	0.500	0.500	0.500
C5-06	ASR Delay Time	0.000 - 0.500	0.001 s	-	0.016	0.004	0.004
C5-07	ASR Gain Switchover Frequency	0.0 - 400.0 *1	0.1	0.0 Hz	0.0 %	0.0 %	0.0 %
C6-02	Carrier Frequency Selection	1 - F	1	2	2	2	2
d3-01	Jump Frequency 1	0.0 - 400.0 *1	0.1	0.0 Hz	0.0 %	0.0 %	0.0 %
d3-02	Jump Frequency 2	0.0 - 400.0 *1	0.1	0.0 Hz	0.0 %	0.0 %	0.0 %
d3-03	Jump Frequency 3	0.0 - 400.0 *1	0.1	0.0 Hz	0.0 %	0.0 %	0.0 %

## 10.18 Parameters that Change from the Default Settings with A1-02 [Control Method Selection]

No.	Name	Setting Range	Unit	Control Method (A1-02 Setting)			
				OLV/PM (5)	AOLV/PM (6)	CLV/PM (7)	EZOLV (8)
d3-04	Jump Frequency Width	0.0 - 20.0 *2	0.1	1.0 Hz	1.0 %	1.0 %	1.0 %
d5-02	Torque Reference Delay Time	0 - 1000	1 ms	-	-	0	-
E1-04	Maximum Output Frequency	40.0 - 400.0 *3	0.1 Hz	Determined by E5-01	Determined by E5-01	Determined by E5-01	-
E1-05	Maximum Output Voltage	0.0 - 255.0 *4	0.1 V	Determined by E5-01	Determined by E5-01	Determined by E5-01	-
E1-06	Base Frequency	0.0 - 400.0	0.1 Hz	Determined by E5-01	Determined by E5-01	Determined by E5-01	-
E1-07	Mid Point A Frequency	0.0 - 400.0	0.1 Hz	-	-	-	-
E1-08	Mid Point A Voltage	0.0 - 255.0 *4	0.1 V	-	-	-	-
E1-09	Minimum Output Frequency	0.0 - 400.0	0.1 Hz	Determined by E5-01	Determined by E5-01	0.0	-
E1-10	Minimum Output Voltage	0.0 - 255.0 *4	0.1 V	-	-	-	-
F1-01	Encoder 1 Pulse Count (PPR)	0 - 60000	1 ppr	1024	1024	1024	600
F1-05	Encoder 1 Rotation Selection	0 - 1	1	1	1	1	0
F1-09	Overspeed Detection Delay Time	0.0 - 2.0	0.1 s	-	-	0.0	-
H4-20	Analog Power Monitor 100% Level	0.00 - 650.00	0.01	Determined by E5-01	Determined by E5-01	Determined by E5-01	Determined by E9-07
L1-01	Motor Overload (oL1) Protection	0 - 4	1	4	4	5	Determined by E9-01
L3-05	Stall Prevention during RUN	0 - 3	1	1	-	-	3
L3-20	DC Bus Voltage Adjustment Gain	0.00 - 5.00	0.01	0.65	0.65	0.65	0.65
L3-21	OVSUPPRESSION Accel/Decel P Gain	0.10 - 10.00	0.01	1.00	1.00	1.00	1.00
L3-36	Current Suppression Gain@Accel	0.0 - 100.0	0.1	-	-	-	-
L4-01	Speed Agree Detection Level	0.0 - 400.0 *1	0.1	0.0 Hz	0.0 %	0.0 %	0.0 %
L4-02	Speed Agree Detection Width	0.0 - 20.0 *2	0.1	2.0 Hz	4.0%	4.0%	4.0%
L4-03	Speed Agree Detection Level (+/-)	-400.0 - +400.0 *5	0.1	0.0 Hz	0.0 %	0.0 %	0.0 %
L4-04	Speed Agree Detection Width (+/-)	0.0 - 20.0 *2	0.1	2.0 Hz	4.0%	4.0%	4.0%
L8-38	Carrier Frequency Reduction	0 - 2	1	0	0	0	0
L8-40	Carrier Freq Reduction Off-Delay	0.00 - 2.00	0.01 s	0.00	0.00	0.00	0.00

## 10.18 Parameters that Change from the Default Settings with A1-02 [Control Method Selection]

No.	Name	Setting Range	Unit	Control Method (A1-02 Setting)			
				OLV/PM (5)	AOLV/PM (6)	CLV/PM (7)	EZOLV (8)
n1-15	PWM Voltage Offset Calibration	0 - 2	1	1	1	1	1
o1-03	Frequency Display Unit Selection	0 - 3	1	0	1	1	1
o1-04	V/f Pattern Display Unit	0 - 1	1	-	1	1	-

- \*1 The setting range is 0.0 to 100.0 when A1-02 = 6 or 7 [PM Advanced Open Loop Vector or PM Closed Loop Vector].
- \*2 The setting range is 0.0 to 40.0 when A1-02 = 6 or 7 [PM Advanced Open Loop Vector or PM Closed Loop Vector].
- \*3 The default setting varies depending on the setting of C6-01 [Normal / Heavy Duty Selection].
- \*4 This is the value for 200 V class drives. Double the value for 400 V class drives.
- \*5 The setting range is -100.0 to +100.0 when A1-02 = 6 or 7 [PM Advanced Open Loop Vector or PM Closed Loop Vector].

## 10.19 E3-01 [Motor 2 Control Mode] Dependent Parameters

The values for the parameters in these tables depend on the values for parameter *E3-01*. Changing the setting for *E3-01* will change the default settings.

No.	Name	Setting Range	Unit	Motor 2 Control Method (setting value of E3-01)			
				V/f (0)	CL-V/f (1)	OLV (2)	CLV (3)
C3-21	Motor 2 Slip Compensation Gain	0.0 to 2.50	0.1	0.0	-	1.0	1.0
C3-22	Motor 2 Slip Comp DelayTime	0 to 10000	1 ms	2000	-	200	-
C5-21	Motor 2 ASR Proportional Gain 1 (P)	0.00 to 300.00	0.01	-	0.20	-	20.00
C5-22	Motor 2 ASR Integral Time 1 (I)	0.000 to 10.000	0.001 s	-	0.200	-	0.500
C5-23	Motor 2 ASR Proportional Gain 2 (P)	0.00 to 300.00	0.01	-	0.02	-	20.00
C5-24	Motor 2 ASR Integral Time 2 (I)	0.000 to 10.000	0.001 s	-	0.050	-	0.500
C5-26	Motor 2 ASR Delay Time	0.000 to 0.500	0.001 s	-	-	-	0.004
E3-04	Motor 2 Maximum Output Frequency	40.0 to 590.0	0.1 Hz	60.0	60.0	60.0	60.0
E3-05	Motor 2 Maximum Output Voltage	0.0 to 255.0 */	0.1 V	200.0	200.0	200.0	200.0
E3-06	Motor 2 Base Frequency	0.0 to 590.0	0.1 Hz	60.0	60.0	60.0	60.0
E3-07	Motor 2 Mid Point A Frequency	0.0 to 590.0	0.1 Hz	3.0	3.0	3.0	0.0
E3-08	Motor 2 Mid Point A Voltage	0.0 to 255.0 */	0.1 V	15.0	15.0	11.0	0.0
E3-09	Motor 2 Minimum Output Frequency	0.0 to 590.0	0.1 Hz	1.5	1.5	0.5	0.0
E3-10	Motor 2 Minimum Output Voltage	0.0 to 255.0 */	0.1 V	9.0	9.0	2.0	0.0
E3-11	Motor 2 Mid Point B Frequency	0.0 to 590.0	Determined by o1-04	0.0	0.0	0.0	0.0
E3-12	Motor 2 Mid Point B Voltage	0.0 to 255.0 */	0.1 V	0.0	0.0	0.0	0.0
E3-13	Motor 2 Base Voltage	0.0 to 255.0 */	0.1 V	0.0	0.0	0.0	0.0

\*1 This is the value for 200 V class drives. Double the value for 400 V class drives.

## 10.20 Parameters Changed by E1-03 [V/f Pattern Selection]

The values for the parameters in these tables depend on the values for parameter *A1-02* and *E1-03*. Changing the settings for *A1-02* and *E1-03* will change the default settings.

**Table 10.1 Parameters Changed by E1-03 (2004 to 2021 and 4002 to 4012)**

No.	Unit	Setting																Control Method (Value set in A1-02)				
		0	1	2	3	4	5	6	7	8	9	A	B	C	D	E	F	OL V (2)	CLV (3)	OL V/ PM (5)	AO LV/ PM (6)	CL V/ PM (7)
E1-04	Hz	50.0	60.0	60.0	72.0	50.0	50.0	60.0	60.0	50.0	50.0	60.0	60.0	90.0	120.0	180.0	50.0 <sup>*1</sup>	50.0	50.0	*2	*2	*2
E1-05 <sup>*3</sup>	V	200.0	200.0	200.0	200.0	200.0	200.0	200.0	200.0	200.0	200.0	200.0	200.0	200.0	200.0	200.0	200.0 <sup>*1</sup>	200.0	200.0	*2	*2	*2
E1-06	Hz	50.0	60.0	50.0	60.0	50.0	50.0	60.0	60.0	50.0	50.0	60.0	60.0	60.0	60.0	60.0	50.0 <sup>*1</sup>	50.0	50.0	*2	*2	*2
E1-07	Hz	2.5	3.0	3.0	3.0	25.0	25.0	30.0	30.0	2.5	2.5	3.0	3.0	3.0	3.0	3.0	2.5 <sup>*1</sup>	3.0	0.0	-	-	-
E1-08 <sup>*3</sup>	V	15.0	15.0	15.0	15.0	35.0	50.0	35.0	50.0	19.0	24.0	19.0	24.0	15.0	15.0	15.0	15.0 <sup>*1</sup>	14.4	0.0	-	-	-
E1-09	Hz	1.3	1.5	1.5	1.5	1.3	1.3	1.5	1.5	1.3	1.3	1.5	1.5	1.5	1.5	1.5	1.3 <sup>*1</sup>	0.5	0.0	*2	*2	0.0
E1-10 <sup>*3</sup>	V	9.0	9.0	9.0	9.0	8.0	9.0	8.0	9.0	11.0	13.0	11.0	15.0	9.0	9.0	9.0	9.0 <sup>*1</sup>	3.0	0.0	-	-	-

\*1 These values are the default settings for *E1-04* through *E1-10* and *E3-04* through *E3-10* [V/f Pattern for Motor 2]. These settings are the same as those for the V/f pattern when *E1-03* = 1 [Constant Trq\_60Hz base\_60Hz max].

\*2 The default setting varies depending on the setting of *E5-01* [Motor Code Selection].

\*3 This is the value for 200 V class drives. Double the value for 400 V class drives.

**Table 10.2 Parameters Changed by E1-03 (2030 to 2211 and 4018 to 4103)**

No.	Unit	Setting																Control Method (Value set in A1-02)				
		0	1	2	3	4	5	6	7	8	9	A	B	C	D	E	F	OL V (2)	CLV (3)	OL V/ PM (5)	AO LV/ PM (6)	CL V/ PM (7)
E1-04	Hz	50.0	60.0	60.0	72.0	50.0	50.0	60.0	60.0	50.0	50.0	60.0	60.0	90.0	120.0	180.0	50.0 <sup>*1</sup>	50.0	50.0	*2	*2	*2
E1-05 <sup>*3</sup>	V	200.0	200.0	200.0	200.0	200.0	200.0	200.0	200.0	200.0	200.0	200.0	200.0	200.0	200.0	200.0	200.0 <sup>*1</sup>	200.0	200.0	*2	*2	*2
E1-06	Hz	50.0	60.0	50.0	60.0	50.0	50.0	60.0	60.0	50.0	50.0	60.0	60.0	60.0	60.0	60.0	50.0 <sup>*1</sup>	50.0	50.0	*2	*2	*2
E1-07	Hz	2.5	3.0	3.0	3.0	25.0	25.0	30.0	30.0	2.5	2.5	3.0	3.0	3.0	3.0	3.0	2.5 <sup>*1</sup>	3.0	0.0	-	-	-
E1-08 <sup>*3</sup>	V	14.0	14.0	14.0	14.0	35.0	50.0	35.0	50.0	18.0	23.0	18.0	23.0	14.0	14.0	14.0	14.0 <sup>*1</sup>	13.2	0.0	-	-	-
E1-09	Hz	1.3	1.5	1.5	1.5	1.3	1.3	1.5	1.5	1.3	1.3	1.5	1.5	1.5	1.5	1.5	1.3 <sup>*1</sup>	0.5	0.0	*2	*2	0.0
E1-10 <sup>*3</sup>	V	7.0	7.0	7.0	7.0	6.0	7.0	6.0	7.0	9.0	11.0	9.0	13.0	7.0	7.0	7.0	7.0 <sup>*1</sup>	2.4	0.0	-	-	-

\*1 These values are the default settings for *E1-04* through *E1-10* and *E3-04* through *E3-10* [V/f Pattern for Motor 2]. These settings are the same as those for the V/f pattern when *E1-03* = 1 [Constant Trq\_60Hz base\_60Hz max].

## 10.20 Parameters Changed by E1-03 [V/f Pattern Selection]

\*2 The default setting varies depending on the setting of E5-01 [Motor Code Selection].

\*3 This is the value for 200 V class drives. Double the value for 400 V class drives.

**Table 10.3 Parameters Changed by E1-03 (2257 to 2415 and 4140 to 4675)**

No.	Unit	Setting																Control Method (Value set in A1-02)				
		0	1	2	3	4	5	6	7	8	9	A	B	C	D	E	F	OL V (2)	CLV (3)	OL V/PM (5)	AO LV/PM (6)	CL V/PM (7)
E1-04	Hz	50.0	60.0	60.0	72.0	50.0	50.0	60.0	60.0	50.0	50.0	60.0	60.0	90.0	120.0	180.0	50.0 <sup>*1</sup>	50.0	50.0	*2	*2	*2
E1-05 <sup>*3</sup>	V	200.0	200.0	200.0	200.0	200.0	200.0	200.0	200.0	200.0	200.0	200.0	200.0	200.0	200.0	200.0	200.0 <sup>*1</sup>	200.0	200.0	*2	*2	*2
E1-06	Hz	50.0	60.0	50.0	60.0	50.0	50.0	60.0	60.0	50.0	50.0	60.0	60.0	60.0	60.0	60.0	50.0 <sup>*1</sup>	50.0	50.0	*2	*2	*2
E1-07	Hz	2.5	3.0	3.0	3.0	25.0	25.0	30.0	30.0	2.5	2.5	3.0	3.0	3.0	3.0	3.0	2.5 <sup>*1</sup>	3.0	0.0	-	-	-
E1-08 <sup>*3</sup>	V	12.0	12.0	12.0	12.0	35.0	50.0	35.0	50.0	15.0	20.0	15.0	20.0	12.0	12.0	12.0	12.0 <sup>*1</sup>	13.2	0.0	-	-	-
E1-09	Hz	1.3	1.5	1.5	1.5	1.3	1.3	1.5	1.5	1.3	1.3	1.5	1.5	1.5	1.5	1.5	1.3 <sup>*1</sup>	0.5	0.0	*2	*2	0.0
E1-10 <sup>*3</sup>	V	6.0	6.0	6.0	6.0	5.0	6.0	5.0	6.0	7.0	9.0	7.0	11.0	6.0	6.0	6.0	6.0 <sup>*1</sup>	2.4	0.0	-	-	-

\*1 These values are the default settings for E1-04 through E1-10 and E3-04 through E3-10 [V/f Pattern for Motor 2]. These settings are the same as those for the V/f pattern when E1-03 = 1 [Constant Trq\_60Hz base\_60Hz max].

\*2 The default setting varies depending on the setting of E5-01 [Motor Code Selection].

\*3 This is the value for 200 V class drives. Double the value for 400 V class drives.

## 10.21 Defaults by Drive Model and Duty Rating ND/HD

The values for the parameters in these tables depend on the values for parameters *o2-04* and *C6-01*. Changing the settings for *o2-04* and *C6-01* will change the default settings.

### ◆ 200 V class

No. */	Name	Unit	Default					
			2004		2006		2010	
-	Drive Model	-	HD	(ND)	HD	(ND)	HD	(ND)
C6-01	Normal / Heavy Duty Selection	-	0	1	0	1	0	1
o2-04	Drive Model (KVA) Selection	Hex.	62		63		65	
E2-11 (E4-11)	Motor Rated Power (kW)	kW	0.55	0.75	0.75	1.1	1.5	2.2
b3-04	V/f Gain during Speed Search	%	100	100	100	100	100	100
b3-06	Speed Estimation Current Level 1	-	1	1	0.5	0.5	0.5	0.5
b3-08	Speed Estimation ACR P Gain	-	0.5	0.5	0.5	0.5	0.5	0.5
b3-26	Direction Determination Level	-	1000	1000	1000	1000	1000	1000
b8-03	Energy Saving Filter Time	s	0.50	0.50	0.50	0.50	0.50	0.50
b8-04	Energy Saving Coefficient Value	-	288.2	223.7	223.7	196.6	169.4	156.8
C5-17 (C5-37)	Motor Inertia	kgm <sup>2</sup>	0.0015	0.0028	0.0028	0.0068	0.0068	0.0088
C6-02	Carrier Frequency Selection	-	1	7	1	7	1	7
E2-01 (E4-01)	Motor Rated Current (FLA)	A	1.9	3.3	3.3	4.9	6.2	8.5
E2-02 (E4-02)	Motor Rated Slip	Hz	2.9	2.5	2.5	2.6	2.6	2.9
E2-03 (E4-03)	Motor No-Load Current	A	1.2	1.8	1.8	2.3	2.8	3
E2-05 (E4-05)	Motor Line-to-Line Resistance	Ω	9.842	5.156	5.156	3.577	1.997	1.601
E2-06 (E4-06)	Motor Leakage Inductance	%	18.2	13.8	13.8	18.5	18.5	18.4
E2-10 (E4-10)	Motor Iron Loss	W	14	26	26	38	53	77
E5-01	PM Motor Code Selection	-	1202	1202	1203	1203	1205	1205

## 10.21 Defaults by Drive Model and Duty Rating ND/HD

No. */	Name	Unit	Default					
			2004		2006		2010	
-	Drive Model	-	HD	(ND)	HD	(ND)	HD	(ND)
C6-01	Normal / Heavy Duty Selection	-	0	1	0	1	0	1
o2-04	Drive Model (KVA) Selection	Hex.	62		63		65	
E2-11 (E4-11)	Motor Rated Power (kW)	kW	0.55	0.75	0.75	1.1	1.5	2.2
L2-02	Power Loss Ride Through Time	s	0.1	0.1	0.2	0.2	0.3	0.3
L2-03	Minimum Baseblock Time	s	0.2	0.3	0.3	0.4	0.4	0.5
L2-04	Powerloss V/f Recovery Ramp Time	s	0.3	0.3	0.3	0.3	0.3	0.3
L2-05	Undervoltage Detection Lvl (Uv1)	-	190	190	190	190	190	190
L3-24	Motor Accel Time @ Rated Torque	s	0.178	0.142	0.142	0.142	0.166	0.145
L8-02	Overheat Alarm Level	°C	115	115	115	115	115	115
L8-09	Output Ground Fault Detection	-	1	1	1	1	1	1
L8-38	Carrier Frequency Reduction	-	2	2	2	2	2	2
n1-01	Hunting Prevention Selection	-	1	1	1	1	1	1
n1-03	Hunting Prevention Time Constant	ms	10	10	10	10	10	10
n1-16	Hunting Prevention High Fc Gain	-	0.50	0.50	0.50	0.50	0.50	0.50
n5-02	Motor Inertia Acceleration Time	s	0.178	0.142	0.142	0.142	0.166	0.145
n8-11	Observer Calculation Gain 2	-	30.0	30.0	30.0	30.0	30.0	30.0

\*1 Parameters within parentheses are for motor 2.



No. */	Name	Unit	Default							
			2012		2018		2021		2030	
-	Drive Model	-	HD	(ND)	HD1	ND1	HD1	ND1	HD	(ND)
C6-01	Normal / Heavy Duty Selection	-	0	1	0	1	0	1	0	1
o2-04	Drive Model (KVA) Selection	Hex.	66		67		68		6A	
E2-11 (E4-11)	Motor Rated Power (kW)	kW	2.2	3.0	3.0	3.7	3.7	5.5	5.5	7.5
b3-04	V/f Gain during Speed Search	%	100	100	100	100	100	100	100	100
b3-06	Speed Estimation Current Level 1	-	0.5	0.5	0.5	0.5	0.5	0.5	0.5	0.5
b3-08	Speed Estimation ACR P Gain	-	0.5	0.5	0.5	0.5	0.5	0.5	0.5	0.5
b3-26	Direction Determination Level	-	1000	1000	1000	1000	1000	1000	1000	1000
b8-03	Energy Saving Filter Time	s	0.50	0.50	0.50	0.50	0.50	0.50	0.50	0.50
b8-04	Energy Saving Coefficient Value	-	156.8	136.4	136.4	122.9	122.9	94.75	94.75	72.69
C5-17 (C5-37)	Motor Inertia	kgm <sup>2</sup>	0.0088	0.0158	0.0158	0.0158	0.0158	0.0255	0.026	0.037
C6-02	Carrier Frequency Selection	-	1	7	1	7	1	7	1	7
E2-01 (E4-01)	Motor Rated Current (FLA)	A	8.5	11.4	11.4	14	14	19.6	19.6	26.6
E2-02 (E4-02)	Motor Rated Slip	Hz	2.9	2.7	2.7	2.73	2.73	1.5	1.5	1.3
E2-03 (E4-03)	Motor No-Load Current	A	3	3.7	3.7	4.5	4.5	5.1	5.1	8
E2-05 (E4-05)	Motor Line-to-Line Resistance	Ω	1.601	1.034	1.034	0.771	0.771	0.399	0.399	0.288
E2-06 (E4-06)	Motor Leakage Inductance	%	18.4	19	19	19.6	19.6	18.2	18.2	15.5
E2-10 (E4-10)	Motor Iron Loss	W	77	91	91	112	112	172	172	262
E5-01	PM Motor Code Selection	-	1206	1206	FFFF	FFFF	1208	1208	120A	120A

## 10.21 Defaults by Drive Model and Duty Rating ND/HD

No. *1	Name	Unit	Default							
			2012		2018		2021		2030	
-	Drive Model	-	HD	(ND)	HD1	ND1	HD1	ND1	HD	(ND)
C6-01	Normal / Heavy Duty Selection	-	0	1	0	1	0	1	0	1
o2-04	Drive Model (KVA) Selection	Hex.	66		67		68		6A	
E2-11 (E4-11)	Motor Rated Power (kW)	kW	2.2	3.0	3.0	3.7	3.7	5.5	5.5	7.5
L2-02	Power Loss Ride Through Time	s	0.5	0.5	1	1	1	1	1	1
L2-03	Minimum Baseblock Time	s	0.5	0.5	0.5	0.6	0.6	0.7	0.7	0.8
L2-04	Powerloss V/f Recovery Ramp Time	s	0.3	0.3	0.3	0.3	0.3	0.3	0.3	0.3
L2-05	Undervoltage Detection Lvl (Uv1)	-	190	190	190	190	190	190	190	190
L3-24	Motor Accel Time @ Rated Torque	s	0.145	0.145	0.145	0.154	0.154	0.168	0.168	0.175
L8-02	Overheat Alarm Level	°C	124	124	110	110	110	110	110	110
L8-09	Output Ground Fault Detection	-	1	1	1	1	1	1	1	1
L8-38	Carrier Frequency Reduction	-	2	2	2	2	2	2	2	2
n1-01	Hunting Prevention Selection	-	1	1	1	1	1	1	1	1
n1-03	Hunting Prevention Time Constant	ms	10	10	10	10	10	10	10	10
n1-16	Hunting Prevention High Fc Gain	-	0.50	0.50	0.50	0.50	0.50	0.50	0.50	0.50
n5-02	Motor Inertia Acceleration Time	s	0.145	0.145	0.145	0.154	0.154	0.168	0.168	0.175
n8-11	Observer Calculation Gain 2	-	30.0	30.0	30.0	30.0	30.0	30.0	30.0	30.0

\*1 Parameters within parentheses are for motor 2.

No. */	Name	Unit	Default							
			2042		2056		2070		2082	
-	Drive Model	-	HD	(ND)	HD	(ND)	HD	(ND)	HD	(ND)
C6-01	Normal / Heavy Duty Selection	-	0	1	0	1	0	1	0	1
o2-04	Drive Model (KVA) Selection	Hex.	6B		6D		6E		6F	
E2-11 (E4-11)	Motor Rated Power (kW)	kW	7.5	11	11	15	15	18.5	18.5	22
b3-04	V/f Gain during Speed Search	%	100	100	100	100	100	100	100	100
b3-06	Speed Estimation Current Level 1	-	0.5	0.5	0.5	0.5	0.5	0.5	0.5	0.5
b3-08	Speed Estimation ACR P Gain	-	0.5	0.5	0.5	0.5	0.5	0.5	0.5	0.5
b3-26	Direction Determination Level	-	1000	1000	1000	1000	1000	1000	1000	1000
b8-03	Energy Saving Filter Time	s	0.50	0.50	0.50	0.50	0.50	0.50	0.50	0.50
b8-04	Energy Saving Coefficient Value	-	72.69	70.44	70.44	63.13	63.13	57.87	57.87	51.79
C5-17 (C5-37)	Motor Inertia	kgm <sup>2</sup>	0.037	0.053	0.053	0.076	0.076	0.138	0.138	0.165
C6-02	Carrier Frequency Selection	-	1	7	1	7	1	7	1	7
E2-01 (E4-01)	Motor Rated Current (FLA)	A	26.6	39.7	39.7	53	53	65.8	65.8	77.2
E2-02 (E4-02)	Motor Rated Slip	Hz	1.3	1.7	1.7	1.6	1.6	1.67	1.67	1.7
E2-03 (E4-03)	Motor No-Load Current	A	8	11.2	11.2	15.2	15.2	15.7	15.7	18.5
E2-05 (E4-05)	Motor Line-to-Line Resistance	Ω	0.288	0.23	0.23	0.138	0.138	0.101	0.101	0.079
E2-06 (E4-06)	Motor Leakage Inductance	%	15.5	19.5	19.5	17.2	17.2	15.7	20.1	19.5
E2-10 (E4-10)	Motor Iron Loss	W	262	245	245	272	272	505	505	538
E5-01	PM Motor Code Selection	-	120B	120B	120D	120D	120E	120E	120F	120F

## 10.21 Defaults by Drive Model and Duty Rating ND/HD

No. *1	Name	Unit	Default							
			2042		2056		2070		2082	
-	Drive Model	-	HD	(ND)	HD	(ND)	HD	(ND)	HD	(ND)
C6-01	Normal / Heavy Duty Selection	-	0	1	0	1	0	1	0	1
o2-04	Drive Model (KVA) Selection	Hex.	6B		6D		6E		6F	
E2-11 (E4-11)	Motor Rated Power (kW)	kW	7.5	11	11	15	15	18.5	18.5	22
L2-02	Power Loss Ride Through Time	s	1	1	2	2	2	2	2	2
L2-03	Minimum Baseblock Time	s	0.8	0.9	0.9	1	1	1	1	1
L2-04	Powerloss V/f Recovery Ramp Time	s	0.3	0.3	0.3	0.6	0.6	0.6	0.6	0.6
L2-05	Undervoltage Detection Lvl (Uv1)	-	190	190	190	190	190	190	190	190
L3-24	Motor Accel Time @ Rated Torque	s	0.175	0.265	0.265	0.244	0.244	0.317	0.317	0.355
L8-02	Overheat Alarm Level	°C	110	110	115	115	120	120	133	130
L8-09	Output Ground Fault Detection	-	1	1	1	1	1	1	1	1
L8-38	Carrier Frequency Reduction	-	2	2	2	2	2	2	2	2
n1-01	Hunting Prevention Selection	-	1	1	2	2	2	2	2	2
n1-03	Hunting Prevention Time Constant	ms	10	10	10	10	10	10	10	10
n1-16	Hunting Prevention High Fc Gain	-	0.50	0.50	0.50	0.50	0.50	0.50	0.50	0.50
n5-02	Motor Inertia Acceleration Time	s	0.175	0.265	0.265	0.244	0.244	0.317	0.317	0.355
n8-11	Observer Calculation Gain 2	-	30.0	30.0	50.0	50.0	50.0	50.0	50.0	50.0

\*1 Parameters within parentheses are for motor 2.

No. */	Name	Unit	Default							
			2110		2138		2169		2211	
-	Drive Model	-	HD	(ND)	HD	(ND)	HD	(ND)	HD	(ND)
C6-01	Normal / Heavy Duty Selection	-	0	1	0	1	0	1	0	1
o2-04	Drive Model (KVA) Selection	Hex.	70		72		73		74	
E2-11 (E4-11)	Motor Rated Power (kW)	kW	22	30	30	37	37	45	45	55
b3-04	V/f Gain during Speed Search	%	100	80	80	80	80	80	80	80
b3-06	Speed Estimation Current Level 1	-	0.5	0.5	0.5	0.5	0.5	0.5	0.5	0.5
b3-08	Speed Estimation ACR P Gain	-	0.5	0.5	0.5	0.5	0.5	0.5	0.5	0.5
b3-26	Direction Determination Level	-	1000	1000	1000	1000	1000	1000	1000	1000
b8-03	Energy Saving Filter Time	s	0.50	0.50	0.50	0.50	0.50	0.50	0.50	2.00
b8-04	Energy Saving Coefficient Value	-	51.79	46.27	46.27	38.16	38.16	35.78	35.78	31.35
C5-17 (C5-37)	Motor Inertia	kgm <sup>2</sup>	0.165	0.220	0.220	0.273	0.273	0.333	0.333	0.490
C6-02	Carrier Frequency Selection	-	1	7	1	7	1	7	1	7
E2-01 (E4-01)	Motor Rated Current (FLA)	A	77.2	105	105	131	131	160	160	190
E2-02 (E4-02)	Motor Rated Slip	Hz	1.7	1.8	1.8	1.33	1.33	1.6	1.6	1.43
E2-03 (E4-03)	Motor No-Load Current	A	18.5	21.9	21.9	38.2	38.2	44	44	45.6
E2-05 (E4-05)	Motor Line-to-Line Resistance	Ω	0.079	0.064	0.064	0.039	0.039	0.03	0.03	0.022
E2-06 (E4-06)	Motor Leakage Inductance	%	19.5	20.8	20.8	18.8	18.8	20.2	20.2	20.5
E2-10 (E4-10)	Motor Iron Loss	W	538	699	699	823	823	852	852	960
E5-01	PM Motor Code Selection	-	1210	1210	1212	1212	1213	1213	1214	1214

## 10.21 Defaults by Drive Model and Duty Rating ND/HD

No. *1	Name	Unit	Default							
			2110		2138		2169		2211	
-	Drive Model	-	HD	(ND)	HD	(ND)	HD	(ND)	HD	(ND)
C6-01	Normal / Heavy Duty Selection	-	0	1	0	1	0	1	0	1
o2-04	Drive Model (KVA) Selection	Hex.	70		72		73		74	
E2-11 (E4-11)	Motor Rated Power (kW)	kW	22	30	30	37	37	45	45	55
L2-02	Power Loss Ride Through Time	s	2	2	2	2	2	2	2	2
L2-03	Minimum Baseblock Time	s	1	1.1	1.1	1.1	1.1	1.2	1.2	1.3
L2-04	Powerloss V/f Recovery Ramp Time	s	0.6	0.6	0.6	0.6	0.6	1	1	1
L2-05	Undervoltage Detection Lvl (Uv1)	-	190	190	190	190	190	190	190	190
L3-24	Motor Accel Time @ Rated Torque	s	0.355	0.323	0.323	0.32	0.32	0.387	0.387	0.317
L8-02	Overheat Alarm Level	°C	105	105	115	115	105	105	105	105
L8-09	Output Ground Fault Detection	-	1	1	1	1	1	1	1	1
L8-38	Carrier Frequency Reduction	-	2	2	2	2	2	2	2	2
n1-01	Hunting Prevention Selection	-	2	2	2	2	2	2	2	2
n1-03	Hunting Prevention Time Constant	ms	10	10	10	10	10	10	10	10
n1-16	Hunting Prevention High Fc Gain	-	0.50	0.50	0.50	0.50	0.50	0.50	0.50	0.50
n5-02	Motor Inertia Acceleration Time	s	0.355	0.323	0.323	0.32	0.32	0.387	0.387	0.317
n8-11	Observer Calculation Gain 2	-	50.0	50.0	50.0	50.0	50.0	50.0	50.0	50.0

\*1 Parameters within parentheses are for motor 2.

No. */	Name	Unit	Default							
			2257		2313		2360		2415	
-	Drive Model	-	HD	(ND)	HD	(ND)	HD	(ND)	HD	(ND)
C6-01	Normal / Heavy Duty Selection	-	0	1	0	1	0	1	0	1
o2-04	Drive Model (KVA) Selection	Hex.	75		76		77		78	
E2-11 (E4-11)	Motor Rated Power (kW)	kW	55	75	75	90	90	110	110	110
b3-04	V/f Gain during Speed Search	%	80	80	80	80	80	80	80	80
b3-06	Speed Estimation Current Level 1	-	0.5	0.7	0.7	0.7	0.7	0.7	0.7	0.7
b3-08	Speed Estimation ACR P Gain	-	0.5	0.5	0.5	0.5	0.5	0.5	0.5	0.5
b3-26	Direction Determination Level	-	1000	1000	1000	1000	1000	1000	1000	1000
b8-03	Energy Saving Filter Time	s	2.00	2.00	2.00	2.00	2.00	2.00	2.00	2.00
b8-04	Energy Saving Coefficient Value	-	31.35	23.1	23.1	20.65	20.65	18.12	18.12	18.12
C5-17 (C5-37)	Motor Inertia	kgm <sup>2</sup>	0.49	0.90	0.90	1.10	1.10	1.90	1.90	1.90
C6-02	Carrier Frequency Selection	-	1	7	1	7	1	7	1	7
E2-01 (E4-01)	Motor Rated Current (FLA)	A	190	260	260	260	260	260	260	260
E2-02 (E4-02)	Motor Rated Slip	Hz	1.43	1.39	1.39	1.39	1.39	1.39	1.39	1.39
E2-03 (E4-03)	Motor No-Load Current	A	45.6	72	72	72	72	72	72	72
E2-05 (E4-05)	Motor Line-to-Line Resistance	Ω	0.022	0.023	0.023	0.023	0.023	0.023	0.023	0.023
E2-06 (E4-06)	Motor Leakage Inductance	%	20.5	20	20	20	20	20	20	20
E2-10 (E4-10)	Motor Iron Loss	W	960	1200	1200	1200	1200	1200	1200	1200
E5-01	PM Motor Code Selection	-	1215	1215	1216	1216	FFFF	FFFF	FFFF	FFFF

## 10.21 Defaults by Drive Model and Duty Rating ND/HD

No. *1	Name	Unit	Default							
			2257		2313		2360		2415	
-	Drive Model	-	HD	(ND)	HD	(ND)	HD	(ND)	HD	(ND)
C6-01	Normal / Heavy Duty Selection	-	0	1	0	1	0	1	0	1
o2-04	Drive Model (KVA) Selection	Hex.	75		76		77		78	
E2-11 (E4-11)	Motor Rated Power (kW)	kW	55	75	75	90	90	110	110	110
L2-02	Power Loss Ride Through Time	s	2	2	2	2	2	2	2	2
L2-03	Minimum Baseblock Time	s	1.3	1.5	1.5	1.5	1.5	1.7	1.7	1.7
L2-04	Powerloss V/f Recovery Ramp Time	s	1	1	1	1	1	1	1	1
L2-05	Undervoltage Detection Lvl (Uv1)	-	190	190	190	190	190	190	190	190
L3-24	Motor Accel Time @ Rated Torque	s	0.317	0.533	0.533	0.592	0.592	0.646	0.646	0.646
L8-02	Overheat Alarm Level	°C	105	105	105	105	120	120	120	120
L8-09	Output Ground Fault Detection	-	1	1	1	1	1	1	1	1
L8-38	Carrier Frequency Reduction	-	2	2	2	2	2	2	2	2
n1-01	Hunting Prevention Selection	-	2	2	2	2	2	2	2	2
n1-03	Hunting Prevention Time Constant	ms	10	10	10	10	100	100	100	100
n1-16	Hunting Prevention High Fc Gain	-	0.50	0.50	0.50	0.50	1.00	1.00	1.00	1.00
n5-02	Motor Inertia Acceleration Time	s	0.317	0.533	0.533	0.592	0.592	0.646	0.646	0.646
n8-11	Observer Calculation Gain 2	-	50.0	50.0	50.0	50.0	50.0	50.0	50.0	50.0

\*1 Parameters within parentheses are for motor 2.



## ◆ 400 V Class

No. */	Name	Unit	Default							
			4002		4004		4005		4007	
-	Drive Model	-	HD1	ND1	HD1	ND1	HD1	ND1	HD1	ND1
C6-01	Normal / Heavy Duty Selection	-	0	1	0	1	0	1	0	1
o2-04	Drive Model (KVA) Selection	Hex.	92		93		94		95	
E2-11 (E4-11)	Motor Rated Power	kW	0.4	0.75	1.1	1.5	1.5	2.2	2.2	3.0
b3-04	V/f Gain during Speed Search	%	100	100	100	100	100	100	100	100
b3-06	Speed Estimation Current Level 1	-	0.5	0.5	0.5	0.5	0.5	0.5	0.5	0.5
b3-08	Speed Estimation ACR P Gain	-	0.5	0.5	0.5	0.5	0.5	0.5	0.5	0.5
b3-26	Direction Determination Level	-	1000	1000	1000	1000	1000	1000	1000	1000
b8-03	Energy Saving Filter Time	s	0.50	0.50	0.50	0.50	0.50	0.50	0.50	0.50
b8-04	Energy Saving Coefficient Value	-	576.4	447.4	447.4	338.8	338.8	313.6	313.6	265.7
C5-17 (C5-37)	Motor Inertia	kgm <sup>2</sup>	0.0015	0.0028	0.0028	0.0068	0.0068	0.0088	0.0088	0.0158
C6-02	Carrier Frequency Selection	-	1	7	1	7	1	7	1	7
E2-01 (E4-01)	Motor Rated Current	A	1	1.6	1.6	3.1	3.1	4.2	4.2	5.7
E2-02 (E4-02)	Motor Rated Slip	Hz	2.9	2.6	2.6	2.5	2.5	3	3	2.7
E2-03 (E4-03)	Motor No-Load Current	A	0.6	0.8	0.8	1.4	1.4	1.5	1.5	1.9
E2-05 (E4-05)	Motor Line-to-Line Resistance	Ω	38.198	22.459	22.459	10.1	10.1	6.495	6.495	4.360
E2-06 (E4-06)	Motor Leakage Inductance	%	18.2	14.3	14.3	18.3	18.3	18.7	18.7	19
E2-10 (E4-10)	Motor Iron Loss	W	14	26	26	53	53	77	77	105
E5-01	PM Motor Code Selection	-	1232	1232	1233	1233	1235	1235	1236	1236

## 10.21 Defaults by Drive Model and Duty Rating ND/HD

No. *1	Name	Unit	Default							
			4002		4004		4005		4007	
-	Drive Model	-	HD1	ND1	HD1	ND1	HD1	ND1	HD1	ND1
C6-01	Normal / Heavy Duty Selection	-	0	1	0	1	0	1	0	1
o2-04	Drive Model (KVA) Selection	Hex.	92		93		94		95	
E2-11 (E4-11)	Motor Rated Power	kW	0.4	0.75	1.1	1.5	1.5	2.2	2.2	3.0
L2-02	Power Loss Ride Through Time	s	0.1	0.1	0.2	0.2	0.3	0.3	0.5	0.5
L2-03	Minimum Baseblock Time	s	0.2	0.3	0.3	0.4	0.4	0.5	0.5	0.5
L2-04	Powerloss V/f Recovery Ramp Time	s	0.3	0.3	0.3	0.3	0.3	0.3	0.3	0.3
L2-05	Undervoltage Detection Lvl (Uv1)	-	380	380	380	380	380	380	380	380
L3-24	Motor Accel Time @ Rated Torque	s	0.178	0.142	0.142	0.166	0.166	0.145	0.145	0.145
L8-02	Overheat Alarm Level	°C	100	100	105	105	112	112	110	110
L8-09	Output Ground Fault Detection	-	1	1	1	1	1	1	1	1
L8-38	Carrier Frequency Reduction	-	2	2	2	2	2	2	2	2
n1-01	Hunting Prevention Selection	-	1	1	1	1	1	1	1	1
n1-03	Hunting Prevention Time Constant	ms	10	10	10	10	10	10	10	10
n1-16	Hunting Prevention High Fc Gain	-	0.50	0.50	0.50	0.50	0.50	0.50	0.50	0.50
n5-02	Motor Inertia Acceleration Time	s	0.178	0.142	0.142	0.166	0.166	0.145	0.145	0.145
n8-11	Observer Calculation Gain 2	-	30.0	30.0	30.0	30.0	30.0	30.0	30.0	30.0

\*1 Parameters within parentheses are for motor 2.

No. */	Name	Unit	Default							
			4009		4012		4018		4023	
-	Drive Model	-	HD1	ND1	HD1	ND1	HD1	ND1	HD1	ND1
C6-01	Normal / Heavy Duty Selection	-	0	1	0	1	0	1	0	1
o2-04	Drive Model (KVA) Selection	Hex.	96		97		99		9A	
E2-11 (E4-11)	Motor Rated Power	kW	3.0	4.0	4.0	5.5	5.5	7.5	7.5	11
b3-04	V/f Gain during Speed Search	%	100	100	100	100	100	100	100	100
b3-06	Speed Estimation Current Level 1	-	0.5	0.5	0.5	0.5	0.5	0.5	0.5	0.5
b3-08	Speed Estimation ACR P Gain	-	0.5	0.5	0.5	0.5	0.5	0.5	0.5	0.5
b3-26	Direction Determination Level	-	1000	1000	1000	1000	1000	1000	1000	1000
b8-03	Energy Saving Filter Time	s	0.50	0.50	0.50	0.50	0.50	0.50	0.50	0.50
b8-04	Energy Saving Coefficient Value	-	265.7	245.8	245.8	189.5	189.5	145.38	145.38	140.88
C5-17 (C5-37)	Motor Inertia	kgm <sup>2</sup>	0.0158	0.0158	0.0158	0.0255	0.026	0.037	0.037	0.053
C6-02	Carrier Frequency Selection	-	1	7	1	7	1	7	1	7
E2-01 (E4-01)	Motor Rated Current (FLA)	A	5.7	7	7	9.8	9.8	13.3	13.3	19.9
E2-02 (E4-02)	Motor Rated Slip	Hz	2.7	2.7	2.7	1.5	1.5	1.3	1.3	1.7
E2-03 (E4-03)	Motor No-Load Current	A	1.9	2.3	2.3	2.6	2.6	4	4	5.6
E2-05 (E4-05)	Motor Line-to-Line Resistance	Ω	4.360	3.333	3.333	1.595	1.595	1.152	1.152	0.922
E2-06 (E4-06)	Motor Leakage Inductance	%	19	19.3	19.3	18.2	18.2	15.5	15.5	19.6
E2-10 (E4-10)	Motor Iron Loss	W	105	130	130	193	193	263	263	385
E5-01	PM Motor Code Selection	-	FFFF	FFFF	1238	1238	123A	123A	123B	123B

## 10.21 Defaults by Drive Model and Duty Rating ND/HD

No. *1	Name	Unit	Default							
			4009		4012		4018		4023	
-	Drive Model	-	HD1	ND1	HD1	ND1	HD1	ND1	HD1	ND1
C6-01	Normal / Heavy Duty Selection	-	0	1	0	1	0	1	0	1
o2-04	Drive Model (KVA) Selection	Hex.	96		97		99		9A	
E2-11 (E4-11)	Motor Rated Power	kW	3.0	4.0	4.0	5.5	5.5	7.5	7.5	11
L2-02	Power Loss Ride Through Time	s	0.5	0.5	0.5	0.5	0.8	0.8	1	1
L2-03	Minimum Baseblock Time	s	0.5	0.6	0.6	0.7	0.7	0.8	0.8	0.9
L2-04	Powerloss V/f Recovery Ramp Time	s	0.3	0.3	0.3	0.3	0.3	0.3	0.3	0.3
L2-05	Undervoltage Detection Lvl (Uv1)	-	380	380	380	380	380	380	380	380
L3-24	Motor Accel Time @ Rated Torque	s	0.145	0.154	0.154	0.168	0.168	0.175	0.175	0.265
L8-02	Overheat Alarm Level	°C	100	100	100	100	105	105	105	105
L8-09	Output Ground Fault Detection	-	1	1	1	1	1	1	1	1
L8-38	Carrier Frequency Reduction	-	2	2	2	2	2	2	2	2
n1-01	Hunting Prevention Selection	-	1	1	1	1	1	1	1	1
n1-03	Hunting Prevention Time Constant	ms	10	10	10	10	10	10	10	10
n1-16	Hunting Prevention High Fc Gain	-	0.50	0.50	0.50	0.50	0.50	0.50	0.50	0.50
n5-02	Motor Inertia Acceleration Time	s	0.145	0.154	0.154	0.168	0.168	0.175	0.175	0.265
n8-11	Observer Calculation Gain 2	-	30.0	30.0	30.0	30.0	30.0	30.0	30.0	30.0

\*1 Parameters within parentheses are for motor 2.

No. */	Name	Unit	Default							
			4031		4038		4044		4060	
-	Drive Model	-	HD1	ND1	HD1	ND1	HD1	ND1	HD1	ND1
C6-01	Normal / Heavy Duty Selection	-	0	1	0	1	0	1	0	1
o2-04	Drive Model (KVA) Selection	Hex.	9C		9D		9E		9F	
E2-11 (E4-11)	Motor Rated Power (kW)	kW	11	15	15	18.5	18.5	22	22	30
b3-04	V/f Gain during Speed Search	%	100	100	100	100	100	100	100	100
b3-06	Speed Estimation Current Level 1	-	0.5	0.5	0.5	0.5	0.5	0.5	0.5	0.5
b3-08	Speed Estimation ACR P Gain	-	0.5	0.5	0.5	0.5	0.5	0.5	0.5	0.5
b3-26	Direction Determination Level	-	1000	1000	1000	1000	1000	1000	1000	1000
b8-03	Energy Saving Filter Time	s	0.50	0.50	0.50	0.50	0.50	0.50	0.50	0.50
b8-04	Energy Saving Coefficient Value	-	140.88	126.26	126.26	115.74	115.74	103.58	103.58	92.54
C5-17 (C5-37)	Motor Inertia	kgm <sup>2</sup>	0.053	0.076	0.076	0.138	0.138	0.165	0.165	0.220
C6-02	Carrier Frequency Selection	-	1	7	1	7	1	7	1	7
E2-01 (E4-01)	Motor Rated Current (FLA)	A	19.9	26.5	26.5	32.9	32.9	38.6	38.6	52.3
E2-02 (E4-02)	Motor Rated Slip	Hz	1.7	1.6	1.6	1.67	1.67	1.7	1.7	1.8
E2-03 (E4-03)	Motor No-Load Current	A	5.6	7.6	7.6	7.8	7.8	9.2	9.2	10.9
E2-05 (E4-05)	Motor Line-to-Line Resistance	Ω	0.922	0.55	0.55	0.403	0.403	0.316	0.316	0.269
E2-06 (E4-06)	Motor Leakage Inductance	%	19.6	17.2	17.2	20.1	20.1	23.5	23.5	20.7
E2-10 (E4-10)	Motor Iron Loss	W	385	440	440	508	508	586	586	750
E5-01	PM Motor Code Selection	-	123D	123D	123E	123E	123F	123F	1240	1240

## 10.21 Defaults by Drive Model and Duty Rating ND/HD

No. *1	Name	Unit	Default							
			4031		4038		4044		4060	
-	Drive Model	-	HD1	ND1	HD1	ND1	HD1	ND1	HD1	ND1
C6-01	Normal / Heavy Duty Selection	-	0	1	0	1	0	1	0	1
o2-04	Drive Model (KVA) Selection	Hex.	9C		9D		9E		9F	
E2-11 (E4-11)	Motor Rated Power (kW)	kW	11	15	15	18.5	18.5	22	22	30
L2-02	Power Loss Ride Through Time	s	2	2	2	2	2	2	2	2
L2-03	Minimum Baseblock Time	s	0.9	1	1	1	1	1	1	1.1
L2-04	Powerloss V/f Recovery Ramp Time	s	0.3	0.6	0.6	0.6	0.6	0.6	0.6	0.6
L2-05	Undervoltage Detection Lvl (Uv1)	-	380	380	380	380	380	380	380	380
L3-24	Motor Accel Time @ Rated Torque	s	0.265	0.244	0.244	0.317	0.317	0.355	0.355	0.323
L8-02	Overheat Alarm Level	°C	100	100	120	120	120	120	130	137
L8-09	Output Ground Fault Detection	-	1	1	1	1	1	1	1	1
L8-38	Carrier Frequency Reduction	-	2	2	2	2	2	2	2	2
n1-01	Hunting Prevention Selection	-	2	2	2	2	2	2	2	2
n1-03	Hunting Prevention Time Constant	ms	10	10	10	10	10	10	10	10
n1-16	Hunting Prevention High Fc Gain	-	0.50	0.50	0.50	0.50	0.50	0.50	0.50	0.50
n5-02	Motor Inertia Acceleration Time	s	0.265	0.244	0.244	0.317	0.317	0.355	0.355	0.323
n8-11	Observer Calculation Gain 2	-	50.0	50.0	50.0	50.0	50.0	50.0	50.0	50.0

\*1 Parameters within parentheses are for motor 2.

No. */	Name	Unit	Default							
			4075		4089		4103		4140	
-	Drive Model	-	HD1	ND1	HD1	ND1	HD1	ND1	HD1	ND1
C6-01	Normal / Heavy Duty Selection	-	0	1	0	1	0	1	0	1
o2-04	Drive Model (KVA) Selection	Hex.	A1		A2		A3		A4	
E2-11 (E4-11)	Motor Rated Power (kW)	kW	30	37	37	45	45	55	55	75
b3-04	V/f Gain during Speed Search	%	100	100	100	100	100	80	80	80
b3-06	Speed Estimation Current Level 1	-	0.5	0.5	0.5	0.5	0.5	0.5	0.5	0.7
b3-08	Speed Estimation ACR P Gain	-	0.5	0.5	0.5	0.5	0.5	0.5	0.5	0.8
b3-26	Direction Determination Level	-	1000	1000	1000	1000	1000	1000	1000	1000
b8-03	Energy Saving Filter Time	s	0.50	0.50	0.50	0.50	0.50	2.00	2.00	2.00
b8-04	Energy Saving Coefficient Value	-	92.54	76.32	76.32	71.56	71.56	67.2	67.2	46.2
C5-17 (C5-37)	Motor Inertia	kgm <sup>2</sup>	0.220	0.273	0.273	0.333	0.333	0.490	0.49	0.90
C6-02	Carrier Frequency Selection	-	1	7	1	7	1	7	1	7
E2-01 (E4-01)	Motor Rated Current (FLA)	A	52.3	65.6	65.6	79.7	79.7	95	95	130
E2-02 (E4-02)	Motor Rated Slip	Hz	1.8	1.33	1.33	1.6	1.6	1.46	1.46	1.39
E2-03 (E4-03)	Motor No-Load Current	A	10.9	19.1	19.1	22	22	24	24	36
E2-05 (E4-05)	Motor Line-to-Line Resistance	Ω	0.269	0.155	0.155	0.122	0.122	0.088	0.088	0.092
E2-06 (E4-06)	Motor Leakage Inductance	%	20.7	18.8	18.8	19.9	19.9	20	20	20
E2-10 (E4-10)	Motor Iron Loss	W	750	925	925	1125	1125	1260	1260	1600
E5-01	PM Motor Code Selection	-	1242	1242	1243	1243	1244	1244	1245	1245

## 10.21 Defaults by Drive Model and Duty Rating ND/HD

No. *1	Name	Unit	Default							
			4075		4089		4103		4140	
-	Drive Model	-	HD1	ND1	HD1	ND1	HD1	ND1	HD1	ND1
C6-01	Normal / Heavy Duty Selection	-	0	1	0	1	0	1	0	1
o2-04	Drive Model (KVA) Selection	Hex.	A1		A2		A3		A4	
E2-11 (E4-11)	Motor Rated Power (kW)	kW	30	37	37	45	45	55	55	75
L2-02	Power Loss Ride Through Time	s	2	2	2	2	2	2	2	2
L2-03	Minimum Baseblock Time	s	1.1	1.1	1.1	1.2	1.2	1.2	1.2	1.3
L2-04	Powerloss V/f Recovery Ramp Time	s	0.6	0.6	0.6	0.6	0.6	1	1	1
L2-05	Undervoltage Detection Lvl (Uv1)	-	380	380	380	380	380	380	380	380
L3-24	Motor Accel Time @ Rated Torque	s	0.323	0.32	0.32	0.387	0.387	0.317	0.317	0.533
L8-02	Overheat Alarm Level	°C	120	120	115	115	126	131	120	120
L8-09	Output Ground Fault Detection	-	1	1	1	1	1	1	1	1
L8-38	Carrier Frequency Reduction	-	2	2	2	2	2	2	2	2
n1-01	Hunting Prevention Selection	-	2	2	2	2	2	2	2	2
n1-03	Hunting Prevention Time Constant	ms	10	10	10	10	10	10	30	30
n1-16	Hunting Prevention High Fc Gain	-	0.50	0.50	0.50	0.50	0.50	0.50	0.50	0.50
n5-02	Motor Inertia Acceleration Time	s	0.323	0.32	0.32	0.387	0.387	0.317	0.317	0.533
n8-11	Observer Calculation Gain 2	-	50.0	50.0	50.0	50.0	50.0	50.0	50.0	50.0

\*1 Parameters within parentheses are for motor 2.



No. */	Name	Unit	Default							
			4168		4208		4250		4296	
-	Drive Model	-	HD1	ND1	HD1	ND1	HD1	ND1	HD1	ND1
C6-01	Normal / Heavy Duty Selection	-	0	1	0	1	0	1	0	1
o2-04	Drive Model (KVA) Selection	Hex.	A5		A6		A7		A8	
E2-11 (E4-11)	Motor Rated Power (kW)	kW	75	90	90	110	110	132	132	160
b3-04	V/f Gain during Speed Search	%	60	60	60	60	60	60	60	60
b3-06	Speed Estimation Current Level 1	-	0.7	0.7	0.7	0.7	0.7	0.7	0.7	0.7
b3-08	Speed Estimation ACR P Gain	-	0.8	0.8	0.8	0.8	0.8	0.8	0.8	0.8
b3-26	Direction Determination Level	-	1000	1000	1000	1000	1000	1000	1000	1000
b8-03	Energy Saving Filter Time	s	2.00	2.00	2.00	2.00	2.00	2.00	2.00	2.00
b8-04	Energy Saving Coefficient Value	-	46.2	38.91	38.91	36.23	36.23	32.79	32.79	30.13
C5-17 (C5-37)	Motor Inertia	kgm <sup>2</sup>	0.90	1.10	1.10	1.90	1.90	2.10	2.10	3.30
C6-02	Carrier Frequency Selection	-	1	7	1	7	1	7	1	7
E2-01 (E4-01)	Motor Rated Current (FLA)	A	130	156	156	190	190	223	223	270
E2-02 (E4-02)	Motor Rated Slip	Hz	1.39	1.4	1.4	1.4	1.4	1.38	1.38	1.35
E2-03 (E4-03)	Motor No-Load Current	A	36	40	40	49	49	58	58	70
E2-05 (E4-05)	Motor Line-to-Line Resistance	Ω	0.092	0.056	0.056	0.046	0.046	0.035	0.035	0.029
E2-06 (E4-06)	Motor Leakage Inductance	%	20	20	20	20	20	20	20	20
E2-10 (E4-10)	Motor Iron Loss	W	1600	1760	1760	2150	2150	2350	2350	2850
E5-01	PM Motor Code Selection	-	1246	1246	1247	1247	1248	1248	1249	1249

## 10.21 Defaults by Drive Model and Duty Rating ND/HD

No. *1	Name	Unit	Default							
			4168		4208		4250		4296	
-	Drive Model	-	HD1	ND1	HD1	ND1	HD1	ND1	HD1	ND1
C6-01	Normal / Heavy Duty Selection	-	0	1	0	1	0	1	0	1
o2-04	Drive Model (KVA) Selection	Hex.	A5		A6		A7		A8	
E2-11 (E4-11)	Motor Rated Power (kW)	kW	75	90	90	110	110	132	132	160
L2-02	Power Loss Ride Through Time	s	2	2	2	2	2	2	2	2
L2-03	Minimum Baseblock Time	s	1.3	1.5	1.5	1.7	1.7	1.7	1.7	1.8
L2-04	Powerloss V/f Recovery Ramp Time	s	1	1	1	1	1	1	1	1
L2-05	Undervoltage Detection Lvl (Uv1)	-	380	380	380	380	380	380	380	380
L3-24	Motor Accel Time @ Rated Torque	s	0.533	0.592	0.592	0.646	0.646	0.673	0.673	0.777
L8-02	Overheat Alarm Level	°C	110	110	105	105	120	120	120	120
L8-09	Output Ground Fault Detection	-	1	1	1	1	1	1	1	1
L8-38	Carrier Frequency Reduction	-	2	2	2	2	2	2	2	2
n1-01	Hunting Prevention Selection	-	2	2	2	2	2	2	2	2
n1-03	Hunting Prevention Time Constant	ms	30	30	30	30	30	30	30	30
n1-16	Hunting Prevention High Fc Gain	-	0.50	0.50	0.50	0.50	0.50	0.50	0.50	0.50
n5-02	Motor Inertia Acceleration Time	s	0.533	0.592	0.592	0.646	0.646	0.673	0.673	0.777
n8-11	Observer Calculation Gain 2	-	50.0	50.0	50.0	50.0	50.0	50.0	50.0	50.0

\*1 Parameters within parentheses are for motor 2.

No. */	Name	Unit	Default							
			4371		4389		4453		4568	
-	Drive Model	-	HD1	ND1	HD1	ND1	HD1	ND1	HD1	ND1
C6-01	Normal / Heavy Duty Selection	-	0	1	0	1	0	1	0	1
o2-04	Drive Model (KVA) Selection	Hex.	A9		AA		AF		AD	
E2-11 (E4-11)	Motor Rated Power (kW)	kW	160	200	200	220	220	250	250	315
b3-04	V/f Gain during Speed Search	%	60	60	60	60	60	60	60	60
b3-06	Speed Estimation Current Level 1	-	0.7	0.7	0.7	0.7	0.7	0.7	0.7	0.7
b3-08	Speed Estimation ACR P Gain	-	0.8	0.8	0.8	0.8	0.8	0.8	0.8	0.8
b3-26	Direction Determination Level	-	1000	1000	1000	1000	1000	1000	1000	1000
b8-03	Energy Saving Filter Time	s	2.00	2.00	2.00	2.00	2.00	2.00	2.00	2.00
b8-04	Energy Saving Coefficient Value	-	30.13	30.57	30.57	27.13	27.13	21.76	21.76	21.76
C5-17 (C5-37)	Motor Inertia	kgm <sup>2</sup>	3.30	3.60	3.60	4.10	4.10	6.50	6.50	11.00
C6-02	Carrier Frequency Selection	-	1	7	1	7	1	7	1	7
E2-01 (E4-01)	Motor Rated Current (FLA)	A	270	310	310	370	370	500	500	500
E2-02 (E4-02)	Motor Rated Slip	Hz	1.35	1.3	1.3	1.3	1.3	1.25	1.25	1.25
E2-03 (E4-03)	Motor No-Load Current	A	70	81	81	96	96	130	130	130
E2-05 (E4-05)	Motor Line-to-Line Resistance	Ω	0.029	0.025	0.025	0.02	0.02	0.014	0.014	0.014
E2-06 (E4-06)	Motor Leakage Inductance	%	20	20	20	20	20	20	20	20
E2-10 (E4-10)	Motor Iron Loss	W	2850	3200	3200	3700	3700	4700	4700	4700
E5-01	PM Motor Code Selection	-	124A	124A	124A	124A	124A	124A	124A	124A

## 10.21 Defaults by Drive Model and Duty Rating ND/HD

No. *1	Name	Unit	Default							
			4371		4389		4453		4568	
-	Drive Model	-	HD1	ND1	HD1	ND1	HD1	ND1	HD1	ND1
C6-01	Normal / Heavy Duty Selection	-	0	1	0	1	0	1	0	1
o2-04	Drive Model (KVA) Selection	Hex.	A9		AA		AF		AD	
E2-11 (E4-11)	Motor Rated Power (kW)	kW	160	200	200	220	220	250	250	315
L2-02	Power Loss Ride Through Time	s	2	2	2	2	2	2	2	2
L2-03	Minimum Baseblock Time	s	1.8	1.9	1.9	2	2	2.1	2.1	2.1
L2-04	Powerloss V/f Recovery Ramp Time	s	1	1	1.8	1.8	1.8	2	2	2
L2-05	Undervoltage Detection Lvl (Uv1)	-	380	380	380	380	380	380	380	380
L3-24	Motor Accel Time @ Rated Torque	s	0.777	0.864	0.864	0.91	0.91	1.392	1.392	1.392
L8-02	Overheat Alarm Level	°C	130	130	140	140	140	140	140	140
L8-09	Output Ground Fault Detection	-	1	1	1	1	1	1	1	1
L8-38	Carrier Frequency Reduction	-	2	2	2	2	2	2	2	2
n1-01	Hunting Prevention Selection	-	2	2	2	2	2	2	2	2
n1-03	Hunting Prevention Time Constant	ms	30	30	100	100	100	100	100	100
n1-16	Hunting Prevention High Fc Gain	-	0.50	0.50	0.50	0.50	0.50	0.50	0.50	0.50
n5-02	Motor Inertia Acceleration Time	s	0.777	0.864	0.864	0.91	0.91	1.392	1.392	1.392
n8-11	Observer Calculation Gain 2	-	50.0	50.0	50.0	50.0	50.0	50.0	50.0	50.0

\*1 Parameters within parentheses are for motor 2.

No. *1	Name	Unit	Default	
-	Drive Model	-	4675	
C6-01	Normal / Heavy Duty Selection	-	HD1	ND1
			0	1
o2-04	Drive Model (KVA) Selection	Hex.	AE	
E2-11 (E4-11)	Motor Rated Power (kW)	kW	315	355
b3-04	V/f Gain during Speed Search	%	60	60
b3-06	Speed Estimation Current Level 1	-	0.7	0.7
b3-08	Speed Estimation ACR P Gain	-	0.8	0.8
b3-26	Direction Determination Level	-	1000	1000
b8-03	Energy Saving Filter Time	s	2.00	2.00
b8-04	Energy Saving Coefficient Value	-	21.76	23.84
C5-17 (C5-37)	Motor Inertia	kgm <sup>2</sup>	11.00	12.00
C6-02	Carrier Frequency Selection	-	1	7
E2-01 (E4-01)	Motor Rated Current (FLA)	A	500	650
E2-02 (E4-02)	Motor Rated Slip	Hz	1.25	1
E2-03 (E4-03)	Motor No-Load Current	A	130	130
E2-05 (E4-05)	Motor Line-to-Line Resistance	Ω	0.014	0.012
E2-06 (E4-06)	Motor Leakage Inductance	%	20	20
E2-10 (E4-10)	Motor Iron Loss	W	4700	5560
E5-01	PM Motor Code Selection	-	FFFF	FFFF
L2-02	Power Loss Ride Through Time	s	2	2
L2-03	Minimum Baseblock Time	s	2.1	2.3
L2-04	Powerloss V/f Recovery Ramp Time	s	2	2.2
L2-05	Undervoltage Detection Lvl (Uv1)	-	380	380
L3-24	Motor Accel Time @ Rated Torque	s	1.392	1.667
L8-02	Overheat Alarm Level	°C	140	140
L8-09	Output Ground Fault Detection	-	1	1
L8-38	Carrier Frequency Reduction	-	2	2
n1-01	Hunting Prevention Selection	-	2	2

## 10.21 Defaults by Drive Model and Duty Rating ND/HD

No. */	Name	Unit	Default	
-	Drive Model	-	4675	
C6-01	Normal / Heavy Duty Selection	-	HD1	ND1
			0	1
o2-04	Drive Model (KVA) Selection	Hex.	AE	
E2-11 (E4-11)	Motor Rated Power (kW)	kW	315	355
n1-03	Hunting Prevention Time Constant	ms	100	100
n1-16	Hunting Prevention High Fc Gain	-	0.50	0.50
n5-02	Motor Inertia Acceleration Time	s	1.392	1.667
n8-11	Observer Calculation Gain 2	-	50.0	50.0

\*1 Parameters within parentheses are for motor 2.

## 10.22 Parameters Changed by PM Motor Code Selection

**Note:**

The motor codes listed in these tables are the only correct setting values.

### ◆ Yaskawa SMRA Series SPM Motors

**Table 10.4 SMRA Series Motor Code Setting for Specification of 200 V at 1800 min<sup>-1</sup> (r/min)**

No.	Name	Unit	Motor Code (setting value of E5-01)				
E5-01	PM Motor Code Selection	-	0002	0003	0005	0006	0008
	Voltage Class	V	200	200	200	200	200
	Capacity	kW	0.4	0.75	1.5	2.2	3.7
	Motor Rotation Speed	min <sup>-1</sup>	1800	1800	1800	1800	1800
E5-02	PM Motor Rated Power (kW)	kW	0.4	0.75	1.5	2.2	3.7
E5-03	PM Motor Rated Current (FLA)	A	2.1	4.0	6.9	10.8	17.4
E5-04	PM Motor Pole Count	-	8	8	8	8	8
E5-05	PM Motor Resistance (ohms/phase)	Ω	2.47	1.02	0.679	0.291	0.169
E5-06	PM d-axis Inductance (mH/phase)	mH	12.7	4.8	3.9	3.6	2.5
E5-07	PM q-axis Inductance (mH/phase)	mH	12.7	4.8	3.9	3.6	2.5
E5-09	PM Back-EMF Vpeak (mV/(rad/s))	mVs/rad	0	0	0	0	0
E5-24	PM Motor Induced Voltage Constant 2 (Ke)	mV/(r/min)	62.0	64.1	73.4	69.6	72.2
E1-04	Maximum Output Frequency	Hz	120	120	120	120	120
E1-05	Maximum Output Voltage	V	200.0	200.0	200.0	200.0	200.0
E1-06	Base Frequency	Hz	120	120	120	120	120
E1-09	Minimum Output Frequency	Hz	6	6	6	6	6
C5-17	Motor Inertia	kgm <sup>2</sup>	0.0007	0.0014	0.0021	0.0032	0.0046
L3-24	Motor Accel Time for Inertia Cal	s	0.064	0.066	0.049	0.051	0.044
n5-02	Motor Acceleration Time	s	0.064	0.066	0.049	0.051	0.044
n8-49	d-Axis Cur for High Efficiency Cont	%	0	0	0	0	0

**Table 10.5 SMRA Series Motor Code Setting for Specification of 200 V at 3600 min<sup>-1</sup> (r/min)**

No.	Name	Unit	Motor Code (setting value of E5-01)			
E5-01	PM Motor Code Selection	-	0103	0105	0106	0108
	Voltage Class	V	200	200	200	200
	Capacity	kW	0.75	1.5	2.2	3.7
	Motor Rotation Speed	min <sup>-1</sup>	3600	3600	3600	3600
E5-02	PM Motor Rated Power (kW)	kW	0.75	1.5	2.2	3.7

## 10.22 Parameters Changed by PM Motor Code Selection

No.	Name	Unit	Motor Code (setting value of E5-01)			
E5-03	PM Motor Rated Current (FLA)	A	4.1	8.0	10.5	16.5
E5-04	PM Motor Pole Count	-	8	8	8	8
E5-05	PM Motor Resistance (ohms/phase)	$\Omega$	0.538	0.20	0.15	0.097
E5-06	PM d-axis Inductance (mH/phase)	mH	3.2	1.3	1.1	1.1
E5-07	PM q-axis Inductance (mH/phase)	mH	3.2	1.3	1.1	1.1
E5-09	PM Back-EMF Vpeak (mV/(rad/s))	mVs/rad	0	0	0	0
E5-24	PM Motor Induced Voltage Constant 2 (Ke)	mV/(r/min)	32.4	32.7	36.7	39.7
E1-04	Maximum Output Frequency	Hz	240	240	240	240
E1-05	Maximum Output Voltage	V	200.0	200.0	200.0	200.0
E1-06	Base Frequency	Hz	240	240	240	240
E1-09	Minimum Output Frequency	Hz	12	12	12	12
C5-17	Motor Inertia	kgm <sup>2</sup>	0.0007	0.0014	0.0021	0.0032
L3-24	Motor Accel Time for Inertia Cal	s	0.137	0.132	0.132	0.122
n5-02	Motor Acceleration Time	s	0.137	0.132	0.132	0.122
n8-49	d-Axis Cur for High Efficiency Cont	%	0	0	0	0

### ◆ Yaskawa SSR1 Series IPM Motors (Derated Torque)

Table 10.6 SSR1 Series Motor Code Setting for Specification of 200 V at 1750 min<sup>-1</sup> (r/min)

No.	Name	Unit	Motor Code (setting value of E5-01)							
E5-01	PM Motor Code Selection	-	1202	1203	1205	1206	1208	120A	120B	120D
	Voltage Class	V	200	200	200	200	200	200	200	200
	Capacity	kW	0.4	0.75	1.5	2.2	3.7	5.5	7.5	11
	Motor Rotation Speed	min <sup>-1</sup>	1750	1750	1750	1750	1750	1750	1750	1750
E5-02	PM Motor Rated Power (kW)	kW	0.4	0.75	1.5	2.2	3.7	5.5	7.5	11.0
E5-03	PM Motor Rated Current (FLA)	A	1.77	3.13	5.73	8.44	13.96	20.63	28.13	41.4
E5-04	PM Motor Pole Count	-	6	6	6	6	6	6	6	6
E5-05	PM Motor Resistance (ohms/phase)	$\Omega$	8.233	2.284	1.470	0.827	0.455	0.246	0.198	0.094
E5-06	PM d-axis Inductance (mH/phase)	mH	54.84	23.02	17.22	8.61	7.20	4.86	4.15	3.40
E5-07	PM q-axis Inductance (mH/phase)	mH	64.10	29.89	20.41	13.50	10.02	7.43	5.91	3.91



No.	Name	Unit	Motor Code (setting value of E5-01)							
E5-09	PM Back-EMF V <sub>peak</sub> (mV/(rad/s))	mVs/rad	223.7	220.3	240.8	238.0	238.7	239.6	258.2	239.3
E5-24	PM Motor Induced Voltage Constant 2 (Ke)	mV/(r/min)	0.0	0.0	0.0	0.0	0.0	0.0	0.0	0.0
E1-04	Maximum Output Frequency	Hz	87.5	87.5	87.5	87.5	87.5	87.5	87.5	87.5
E1-05	Maximum Output Voltage	V	190.0	190.0	190.0	190.0	190.0	190.0	190.0	190.0
E1-06	Base Frequency	Hz	87.5	87.5	87.5	87.5	87.5	87.5	87.5	87.5
E1-09	Minimum Output Frequency	Hz	4.4	4.4	4.4	4.4	4.4	4.4	4.4	4.4
C5-17	Motor Inertia	kgm <sup>2</sup>	0.0011	0.0017	0.0023	0.0043	0.0083	0.014	0.017	0.027
L3-24 *1	Motor Accel Time for Inertia Cal	s	0.092	0.076	0.051	0.066	0.075	0.083	0.077	0.084
n5-02	Motor Acceleration Time	s	0.092	0.076	0.051	0.066	0.075	0.083	0.077	0.084
n8-49	d-Axis Cur for High Efficiency Cont	%	-7.6	-11.5	-9.1	-19.0	-18.7	-23.4	-18.5	-10.9

\*1 Default settings vary depending on the setting of o2-04 (Drive Model Selection).

**Table 10.7 SSR1 Series Motor Code Setting for Specification of 200 V at 1750 min<sup>-1</sup> (r/min)**

No.	Name	Unit	Motor Code (setting value of E5-01)							
E5-01	PM Motor Code Selection	-	120E	120F	1210	1212	1213	1214	1215	1216
	Voltage Class	V	200	200	200	200	200	200	200	200
	Capacity	kW	15	18	22	30	37	45	55	75
	Motor Rotation Speed	min <sup>-1</sup>	1750	1750	1750	1750	1750	1750	1750	1750
E5-02	PM Motor Rated Power (kW)	kW	15.00	18.50	22.00	30.00	37.00	45.00	55.00	75.00
E5-03	PM Motor Rated Current (FLA)	A	55.4	68.2	80.6	105.2	131.3	153.1	185.4	257.3
E5-04	PM Motor Pole Count	-	6	6	6	6	6	6	6	6
E5-05	PM Motor Resistance (ohms/phase)	Ω	0.066	0.051	0.037	0.030	0.020	0.014	0.012	0.006
E5-06	PM d-axis Inductance (mH/phase)	mH	2.45	2.18	1.71	1.35	0.99	0.83	0.79	0.44
E5-07	PM q-axis Inductance (mH/phase)	mH	3.11	2.55	2.05	1.82	1.28	1.01	0.97	0.56
E5-09	PM Back-EMF V <sub>peak</sub> (mV/(rad/s))	mVs/rad	248.1	253.6	250.0	280.9	264.2	280.4	311.9	268.0
E5-24	PM Motor Induced Voltage Constant 2 (Ke)	mV/(r/min)	0.0	0.0	0.0	0.0	0.0	0.0	0.0	0.0
E1-04	Maximum Output Frequency	Hz	87.5	87.5	87.5	87.5	87.5	87.5	87.5	87.5
E1-05	Maximum Output Voltage	V	190.0	190.0	190.0	190.0	190.0	190.0	190.0	190.0
E1-06	Base Frequency	Hz	87.5	87.5	87.5	87.5	87.5	87.5	87.5	87.5

## 10.22 Parameters Changed by PM Motor Code Selection

No.	Name	Unit	Motor Code (setting value of E5-01)							
E1-09	Minimum Output Frequency	Hz	4.4	4.4	4.4	4.4	4.4	4.4	4.4	4.4
C5-17	Motor Inertia	kgm <sup>2</sup>	0.046	0.055	0.064	0.116	0.140	0.259	0.31	0.42
L3-24 */	Motor Accel Time for Inertia Cal	s	0.102	0.101	0.098	0.130	0.127	0.193	0.191	0.187
n5-02	Motor Acceleration Time	s	0.102	0.101	0.098	0.130	0.127	0.193	0.191	0.187
n8-49	d-Axis Cur forHighEfficiency Cont	%	-16.5	-11.3	-12.8	-16.8	-15.6	-10.7	-9.6	-13.3

\*1 Default settings vary depending on the setting of o2-04 (Drive Model Selection).

**Table 10.8 SSR1 Series Motor Code Setting for Specification of 400 V at 1750 min<sup>-1</sup> (r/min)**

No.	Name	Unit	Motor Code (setting value of E5-01)							
E5-01	PM Motor Code Selection	-	1232	1233	1235	1236	1238	123A	123B	123D
	Voltage Class	V	400	400	400	400	400	400	400	400
	Capacity	kW	0.4	0.75	1.5	2.2	3.7	5.5	7.5	11
	Motor Rotation Speed	min <sup>-1</sup>	1750	1750	1750	1750	1750	1750	1750	1750
E5-02	PM Motor Rated Power (kW)	kW	0.4	0.75	1.5	2.2	3.7	5.5	7.5	11.0
E5-03	PM Motor Rated Current (FLA)	A	0.89	1.56	2.81	4.27	7.08	10.31	13.65	20.7
E5-04	PM Motor Pole Count	-	6	6	6	6	6	6	6	6
E5-05	PM Motor Resistance (ohms/phase)	Ω	25.370	9.136	6.010	3.297	1.798	0.982	0.786	0.349
E5-06	PM d-axis Inductance (mH/phase)	mH	169.00	92.08	67.71	34.40	32.93	22.7	16.49	13.17
E5-07	PM q-axis Inductance (mH/phase)	mH	197.50	119.56	81.71	54.00	37.70	26.80	23.46	15.60
E5-09	PM Back-EMF V <sub>peak</sub> (mV/(rad/s))	mVs/rad	392.6	440.6	478.3	466.3	478.8	478.1	520.0	481.5
E5-24	PM Motor Induced Voltage Constant 2 (Ke)	mV/(r/min)	0.0	0.0	0.0	0.0	0.0	0.0	0.0	0.0
E1-04	Maximum Output Frequency	Hz	87.5	87.5	87.5	87.5	87.5	87.5	87.5	87.5
E1-05	Maximum Output Voltage	V	380.0	380.0	380.0	380.0	380.0	380.0	380.0	380.0
E1-06	Base Frequency	Hz	87.5	87.5	87.5	87.5	87.5	87.5	87.5	87.5
E1-09	Minimum Output Frequency	Hz	4.4	4.4	4.4	4.4	4.4	4.4	4.4	4.4
C5-17	Motor Inertia	kgm <sup>2</sup>	0.0011	0.0017	0.0023	0.0043	0.0083	0.014	0.017	0.027
L3-24 */	Motor Accel Time for Inertia Cal	s	0.092	0.076	0.051	0.066	0.075	0.083	0.077	0.084
n5-02	Motor Acceleration Time	s	0.092	0.076	0.051	0.066	0.075	0.083	0.077	0.084
n8-49	d-Axis Cur forHighEfficiency Cont	%	-8.6	-11.5	-10.3	-19.8	-8.5	-11.0	-18.6	-12.5

\*1 Default settings vary depending on the setting of o2-04 (Drive Model Selection).

**Table 10.9 SSR1 Series Motor Code Setting for Specification of 400 V at 1750 min<sup>-1</sup> (r/min)**

No.	Name	Unit	Motor Code (setting value of E5-01)							
E5-01	PM Motor Code Selection	-	123E	123F	1240	1242	1243	1244	1245	1246
	Voltage Class	V	400	400	400	400	400	400	400	400
	Capacity	kW	15	18	22	30	37	45	55	75
	Motor Rotation Speed	min <sup>-1</sup>	1750	1750	1750	1750	1750	1750	1750	1750
E5-02	PM Motor Rated Power (kW)	kW	15	18.50	22.00	30.00	37.00	45.00	55.00	75.00
E5-03	PM Motor Rated Current (FLA)	A	27.5	33.4	39.8	52.0	65.8	77.5	92.7	126.6
E5-04	PM Motor Pole Count	-	6	6	6	6	6	6	6	6
E5-05	PM Motor Resistance (ohms/phase)	Ω	0.272	0.207	0.148	0.235	0.079	0.054	0.049	0.029
E5-06	PM d-axis Inductance (mH/phase)	mH	10.30	8.72	6.81	5.4	4.08	3.36	3.16	2.12
E5-07	PM q-axis Inductance (mH/phase)	mH	12.77	11.22	8.47	7.26	5.12	3.94	3.88	2.61
E5-09	PM Back-EMF V <sub>peak</sub> (mV/(rad/s))	mVs/rad	498.8	509.5	503.9	561.7	528.5	558.1	623.8	594.5
E5-24	PM Motor Induced Voltage Constant 2 (Ke)	mV/(r/min)	0.0	0.0	0.0	0.0	0.0	0.0	0.0	0.0
E1-04	Maximum Output Frequency	Hz	87.5	87.5	87.5	87.5	87.5	87.5	87.5	87.5
E1-05	Maximum Output Voltage	V	380.0	380.0	380.0	380.0	380.0	380.0	380.0	380.0
E1-06	Base Frequency	Hz	87.5	87.5	87.5	87.5	87.5	87.5	87.5	87.5
E1-09	Minimum Output Frequency	Hz	4.4	4.4	4.4	4.4	4.4	4.4	4.4	4.4
C5-17	Motor Inertia	kgm <sup>2</sup>	0.046	0.055	0.064	0.116	0.140	0.259	0.31	0.42
L3-24 */	Motor Accel Time for Inertia Cal	s	0.102	0.101	0.098	0.130	0.127	0.193	0.191	0.187
n5-02	Motor Acceleration Time	s	0.102	0.101	0.098	0.130	0.127	0.193	0.191	0.187
n8-49	d-Axis Cur for High Efficiency Cont	%	-15.5	-17.9	-15.1	-16.8	-14.1	-8.8	-9.6	-10.3

\*1 Default settings vary depending on the setting of o2-04 (Drive Model Selection).

**Table 10.10 SSR1 Series Motor Code Setting for Specification of 400 V at 1750 min<sup>-1</sup> (r/min)**

No.	Name	Unit	Motor Code (setting value of E5-01)			
E5-01	PM Motor Code Selection	-	1247	1248	1249	124A
	Voltage Class	V	400	400	400	400
	Capacity	kW	90	110	132	160
	Motor Rotation Speed	min <sup>-1</sup>	1750	1750	1750	1750
E5-02	PM Motor Rated Power (kW)	kW	90.00	110.00	132.00	160.00
E5-03	PM Motor Rated Current (FLA)	A	160.4	183.3	222.9	267.7

## 10.22 Parameters Changed by PM Motor Code Selection

No.	Name	Unit	Motor Code (setting value of E5-01)			
E5-04	PM Motor Pole Count	-	6	6	6	6
E5-05	PM Motor Resistance (ohms/phase)	$\Omega$	0.019	0.017	0.012	0.008
E5-06	PM d-axis Inductance (mH/phase)	mH	1.54	1.44	1.21	0.97
E5-07	PM q-axis Inductance (mH/phase)	mH	2.06	2.21	1.46	1.28
E5-09	PM Back-EMF Vpeak (mV/(rad/s))	mVs/rad	524.1	583.7	563.6	601.2
E5-24	PM Motor Induced Voltage Constant 2 (Ke)	mV/(r/min)	0.0	0.0	0.0	0.0
E1-04	Maximum Output Frequency	Hz	87.5	87.5	87.5	87.5
E1-05	Maximum Output Voltage	V	380.0	380.0	380.0	380.0
E1-06	Base Frequency	Hz	87.5	87.5	87.5	87.5
E1-09	Minimum Output Frequency	Hz	4.4	4.4	4.4	4.4
C5-17	Motor Inertia	kgm <sup>2</sup>	0.56	0.83	0.96	1.61
L3-24 *1	Motor Accel Time for Inertia Cal	s	0.208	0.254	0.243	0.338
n5-02	Motor Acceleration Time	s	0.208	0.254	0.243	0.338
n8-49	d-Axis Cur forHighEfficiencyCont	%	-17.0	-21.7	-10.9	-13.2

\*1 Default settings vary depending on the setting of o2-04 (Drive Model Selection).

**Table 10.11 SSR1 Series Motor Code Setting for Specification of 200 V at 1450 min<sup>-1</sup> (r/min)**

No.	Name	Unit	Motor Code (setting value of E5-01)							
E5-01	PM Motor Code Selection	-	1302	1303	1305	1306	1308	130A	130B	130D
	Voltage Class	V	200	200	200	200	200	200	200	200
	Capacity	kW	0.4	0.75	1.5	2.2	3.7	5.5	7.5	11
	Motor Rotation Speed	min <sup>-1</sup>	1450	1450	1450	1450	1450	1450	1450	1450
E5-02	PM Motor Rated Power (kW)	kW	0.4	0.75	1.5	2.2	3.7	5.5	7.5	11.0
E5-03	PM Motor Rated Current (FLA)	A	1.88	3.13	5.63	8.33	14.17	20.63	27.71	39.6
E5-04	PM Motor Pole Count	-	6	6	6	6	6	6	6	6
E5-05	PM Motor Resistance (ohms/phase)	$\Omega$	3.190	1.940	1.206	0.665	0.341	0.252	0.184	0.099
E5-06	PM d-axis Inductance (mH/phase)	mH	32.15	26.12	14.72	12.27	8.27	6.49	6.91	4.07
E5-07	PM q-axis Inductance (mH/phase)	mH	41.74	34.30	20.15	14.77	9.81	7.74	7.66	4.65
E5-09	PM Back-EMF Vpeak (mV/(rad/s))	mVs/rad	264.3	269.6	284.3	287.1	284.5	298.0	335.0	303.9
E5-24	PM Motor Induced Voltage Constant 2 (Ke)	mV/(r/min)	0.0	0.0	0.0	0.0	0.0	0.0	0.0	0.0
E1-04	Maximum Output Frequency	Hz	72.5	72.5	72.5	72.5	72.5	72.5	72.5	72.5

No.	Name	Unit	Motor Code (setting value of E5-01)							
E1-05	Maximum Output Voltage	V	190.0	190.0	190.0	190.0	190.0	190.0	190.0	190.0
E1-06	Base Frequency	Hz	72.5	72.5	72.5	72.5	72.5	72.5	72.5	72.5
E1-09	Minimum Output Frequency	Hz	3.6	3.6	3.6	3.6	3.6	3.6	3.6	3.6
C5-17	Motor Inertia	kgm <sup>2</sup>	0.0017	0.0023	0.0043	0.0083	0.0136	0.017	0.027	0.046
L3-24 */	Motor Accel Time for Inertia Cal	s	0.098	0.071	0.066	0.087	0.085	0.072	0.084	0.096
n5-02	Motor Acceleration Time	s	0.098	0.071	0.066	0.087	0.085	0.072	0.084	0.096
n8-49	d-Axis Cur for High Efficiency Cont	%	-6.6	-10.9	-13.5	-9.0	-9.5	-10.1	-6.0	-9.3

\*1 Default settings vary depending on the setting of o2-04 (Drive Model Selection).

**Table 10.12 SSR1 Series Motor Code Setting for Specification of 200 V at 1450 min<sup>-1</sup> (r/min)**

No.	Name	Unit	Motor Code (setting value of E5-01)							
E5-01	PM Motor Code Selection	-	130E	130F	1310	1312	1313	1314	1315	
	Voltage Class	V	200	200	200	200	200	200	200	
	Capacity	kW	15	18	22	30	37	45	55	
	Motor Rotation Speed	min <sup>-1</sup>	1450	1450	1450	1450	1450	1450	1450	
E5-02	PM Motor Rated Power (kW)	kW	15.00	18.50	22.00	30.00	37.00	45.00	55.00	
E5-03	PM Motor Rated Current (FLA)	A	55.5	65.6	75.1	105.2	126.0	153.1	186.5	
E5-04	PM Motor Pole Count	-	6	6	6	6	6	6	6	
E5-05	PM Motor Resistance (ohms/phase)	Ω	0.075	0.057	0.041	0.034	0.023	0.015	0.012	
E5-06	PM d-axis Inductance (mH/phase)	mH	3.29	2.53	1.98	1.75	1.48	1.04	0.87	
E5-07	PM q-axis Inductance (mH/phase)	mH	3.84	3.01	2.60	2.17	1.70	1.31	1.10	
E5-09	PM Back-EMF V <sub>peak</sub> (mV/(rad/s))	mVs/rad	311.2	300.9	327.7	354.2	369.6	351.6	374.7	
E5-24	PM Motor Induced Voltage Constant 2 (Ke)	mV/(r/min)	0.0	0.0	0.0	0.0	0.0	0.0	0.0	
E1-04	Maximum Output Frequency	Hz	72.5	72.5	72.5	72.5	72.5	72.5	72.5	
E1-05	Maximum Output Voltage	V	190.0	190.0	190.0	190.0	190.0	190.0	190.0	
E1-06	Base Frequency	Hz	72.5	72.5	72.5	72.5	72.5	72.5	72.5	
E1-09	Minimum Output Frequency	Hz	3.6	3.6	3.6	3.6	3.6	3.6	3.6	
C5-17	Motor Inertia	kgm <sup>2</sup>	0.055	0.064	0.116	0.140	0.259	0.312	0.42	
L3-24 */	Motor Accel Time for Inertia Cal	s	0.085	0.080	0.122	0.108	0.161	0.160	0.175	

## 10.22 Parameters Changed by PM Motor Code Selection

No.	Name	Unit	Motor Code (setting value of E5-01)						
n5-02	Motor Acceleration Time	s	0.085	0.080	0.122	0.108	0.161	0.160	0.175
n8-49	d-Axis Cur forHighEfficiency Cont	%	-10.7	-13.2	-15.7	-11.5	-7.0	-11.8	-10.2

\*1 Default settings vary depending on the setting of o2-04 (Drive Model Selection).

**Table 10.13 SSR1 Series Motor Code Setting for Specification of 400 V at 1450 min<sup>-1</sup> (r/min)**

No.	Name	Unit	Motor Code (setting value of E5-01)							
E5-01	PM Motor Code Selection	-	1332	1333	1335	1336	1338	133A	133B	133D
	Voltage Class	V	400	400	400	400	400	400	400	400
	Capacity	kW	0.4	0.75	1.5	2.2	3.7	5.5	7.5	11
	Motor Rotation Speed	min <sup>-1</sup>	1450	1450	1450	1450	1450	1450	1450	1450
E5-02	PM Motor Rated Power (kW)	kW	0.4	0.75	1.5	2.2	3.7	5.5	7.5	11.0
E5-03	PM Motor Rated Current (FLA)	A	0.94	1.56	2.81	4.27	6.98	10.21	13.85	19.5
E5-04	PM Motor Pole Count	-	6	6	6	6	6	6	6	6
E5-05	PM Motor Resistance (ohms/phase)	Ω	12.760	7.421	4.825	2.656	1.353	0.999	0.713	0.393
E5-06	PM d-axis Inductance (mH/phase)	mH	128.60	85.11	58.87	46.42	31.73	26.20	27.06	15.51
E5-07	PM q-axis Inductance (mH/phase)	mH	166.96	113.19	80.59	60.32	40.45	30.94	33.45	19.63
E5-09	PM Back-EMF V <sub>peak</sub> (mV/(rad/s))	mVs/rad	528.6	544.2	568.5	572.8	562.9	587.6	670.1	612.7
E5-24	PM Motor Induced Voltage Constant 2 (Ke)	mV/(r/min)	0.0	0.0	0.0	0.0	0.0	0.0	0.0	0.0
E1-04	Maximum Output Frequency	Hz	72.5	72.5	72.5	72.5	72.5	72.5	72.5	72.5
E1-05	Maximum Output Voltage	V	380.0	380.0	380.0	380.0	380.0	380.0	380.0	380.0
E1-06	Base Frequency	Hz	72.5	72.5	72.5	72.5	72.5	72.5	72.5	72.5
E1-09	Minimum Output Frequency	Hz	3.6	3.6	3.6	3.6	3.6	3.6	3.6	3.6
C5-17	Motor Inertia	kgm <sup>2</sup>	0.0017	0.0023	0.0043	0.0083	0.0136	0.017	0.027	0.046
L3-24 *1	Motor Accel Time for Inertia Cal	s	0.098	0.071	0.066	0.087	0.085	0.072	0.084	0.096
n5-02	Motor Acceleration Time	s	0.098	0.071	0.066	0.087	0.085	0.072	0.084	0.096
n8-49	d-Axis Cur forHighEfficiency Cont	%	-6.6	-9.2	-13.5	-12.1	-13.7	-10.1	-12.2	-15.5

\*1 Default settings vary depending on the setting of o2-04 (Drive Model Selection).

Table 10.14 SSR1 Series Motor Code Setting for Specification of 400 V at 1450 min<sup>-1</sup> (r/min)

No.	Name	Unit	Motor Code (setting value of E5-01)						
			133E	133F	1340	1342	1343	1344	1345
E5-01	PM Motor Code Selection	-	133E	133F	1340	1342	1343	1344	1345
	Voltage Class	V	400	400	400	400	400	400	400
	Capacity	kW	15	18	22	30	37	45	55
	Motor Rotation Speed	min <sup>-1</sup>	1450	1450	1450	1450	1450	1450	1450
E5-02	PM Motor Rated Power (kW)	kW	15	18.50	22.00	30.00	37.00	45.00	55.00
E5-03	PM Motor Rated Current (FLA)	A	27.4	32.9	37.6	52.5	63.2	76.4	96.1
E5-04	PM Motor Pole Count	-	6	6	6	6	6	6	6
E5-05	PM Motor Resistance (ohms/phase)	Ω	0.295	0.223	0.164	0.137	0.093	0.059	0.048
E5-06	PM d-axis Inductance (mH/phase)	mH	12.65	9.87	7.90	7.01	5.93	4.17	3.11
E5-07	PM q-axis Inductance (mH/phase)	mH	15.87	12.40	10.38	8.68	6.79	5.22	4.55
E5-09	PM Back-EMF V <sub>peak</sub> (mV/(rad/s))	mVs/rad	624.6	610.4	655.4	708.4	739.2	703.0	747.1
E5-24	PM Motor Induced Voltage Constant 2 (K <sub>e</sub> )	mV/(r/min)	0.0	0.0	0.0	0.0	0.0	0.0	0.0
E1-04	Maximum Output Frequency	Hz	72.5	72.5	72.5	72.5	72.5	72.5	72.5
E1-05	Maximum Output Voltage	V	380.0	380.0	380.0	380.0	380.0	380.0	380.0
E1-06	Base Frequency	Hz	72.5	72.5	72.5	72.5	72.5	72.5	72.5
E1-09	Minimum Output Frequency	Hz	3.6	3.6	3.6	3.6	3.6	3.6	3.6
C5-17	Motor Inertia	kgm <sup>2</sup>	0.055	0.064	0.116	0.140	0.259	0.312	0.42
L3-24 */	Motor Accel Time for Inertia Cal	s	0.085	0.080	0.122	0.108	0.161	0.160	0.175
n5-02	Motor Acceleration Time	s	0.085	0.080	0.122	0.108	0.161	0.160	0.175
n8-49	d-Axis Cur for High Efficiency Cont	%	-15.1	-16.0	-15.7	-11.5	-6.8	-11.5	-14.8

\*1 Default settings vary depending on the setting of o2-04 (Drive Model Selection).

Table 10.15 SSR1 Series Motor Code Setting for Specification of 400 V at 1450 min<sup>-1</sup> (r/min)

No.	Name	Unit	Motor Code (setting value of E5-01)			
			1346	1347	1348	1349
E5-01	PM Motor Code Selection	-	1346	1347	1348	1349
	Voltage Class	V	400	400	400	400
	Capacity	kW	75	90	110	132
	Motor Rotation Speed	min <sup>-1</sup>	1450	1450	1450	1450
E5-02	PM Motor Rated Power (kW)	kW	75.00	90.00	110.00	132.00
E5-03	PM Motor Rated Current (FLA)	A	124.0	153.1	186.5	226.0
E5-04	PM Motor Pole Count	-	6	6	6	6

## 10.22 Parameters Changed by PM Motor Code Selection

No.	Name	Unit	Motor Code (setting value of E5-01)			
E5-05	PM Motor Resistance (ohms/phase)	Ω	0.028	0.024	0.015	0.011
E5-06	PM d-axis Inductance (mH/phase)	mH	2.32	2.20	1.45	1.23
E5-07	PM q-axis Inductance (mH/phase)	mH	2.97	3.23	1.88	1.67
E5-09	PM Back-EMF V <sub>peak</sub> (mV/(rad/s))	mVs/rad	639.3	708.0	640.7	677.0
E5-24	PM Motor Induced Voltage Constant 2 (Ke)	mV/(r/min)	0.0	0.0	0.0	0.0
E1-04	Maximum Output Frequency	Hz	72.5	72.5	72.5	72.5
E1-05	Maximum Output Voltage	V	380.0	380.0	380.0	380.0
E1-06	Base Frequency	Hz	72.5	72.5	72.5	72.5
E1-09	Minimum Output Frequency	Hz	3.6	3.6	3.6	3.6
C5-17	Motor Inertia	kgm <sup>2</sup>	0.56	0.83	0.96	1.61
L3-24 *1	Motor Accel Time for Inertia Cal	s	0.171	0.213	0.201	0.281
n5-02	Motor Acceleration Time	s	0.171	0.213	0.201	0.281
n8-49	d-Axis Cur forHighEfficiencyCont	%	-15.8	-19.6	-14.9	-15.1

\*1 Default settings vary depending on the setting of o2-04 (Drive Model Selection).

**Table 10.16 SSR1 Series Motor Code Setting for Specification of 200 V at 1150 min<sup>-1</sup> (r/min)**

No.	Name	Unit	Motor Code (setting value of E5-01)							
E5-01	PM Motor Code Selection	-	1402	1403	1405	1406	1408	140A	140B	140D
	Voltage Class	V	200	200	200	200	200	200	200	200
	Capacity	kW	0.4	0.75	1.5	2.2	3.7	5.5	7.5	11
	Motor Rotation Speed	min <sup>-1</sup>	1150	1150	1150	1150	1150	1150	1150	1150
E5-02	PM Motor Rated Power (kW)	kW	0.4	0.75	1.5	2.2	3.7	5.5	7.5	11.0
E5-03	PM Motor Rated Current (FLA)	A	1.88	3.02	6.00	8.85	14.27	20.21	26.67	39.9
E5-04	PM Motor Pole Count	-	6	6	6	6	6	6	6	6
E5-05	PM Motor Resistance (ohms/phase)	Ω	4.832	2.704	1.114	0.511	0.412	0.303	0.165	0.113
E5-06	PM d-axis Inductance (mH/phase)	mH	48.68	32.31	19.22	12.15	7.94	11.13	6.59	4.96
E5-07	PM q-axis Inductance (mH/phase)	mH	63.21	40.24	24.38	15.35	11.86	14.06	8.55	6.12
E5-09	PM Back-EMF V <sub>peak</sub> (mV/(rad/s))	mVs/rad	320.4	327.1	364.4	344.4	357.5	430.8	391.5	384.4
E5-24	PM Motor Induced Voltage Constant 2 (Ke)	mV/(r/min)	0.0	0.0	0.0	0.0	0.0	0.0	0.0	0.0
E1-04	Maximum Output Frequency	Hz	57.5	57.5	57.5	57.5	57.5	57.5	57.5	57.5
E1-05	Maximum Output Voltage	V	190.0	190.0	190.0	190.0	190.0	190.0	190.0	190.0



No.	Name	Unit	Motor Code (setting value of E5-01)							
E1-06	Base Frequency	Hz	57.5	57.5	57.5	57.5	57.5	57.5	57.5	57.5
E1-09	Minimum Output Frequency	Hz	2.9	2.9	2.9	2.9	2.9	2.9	2.9	2.9
C5-17	Motor Inertia	kgm <sup>2</sup>	0.0017	0.0023	0.0083	0.0136	0.0171	0.027	0.046	0.055
L3-24 *1	Motor Accel Time for Inertia Cal	s	0.062	0.044	0.080	0.090	0.067	0.072	0.088	0.073
n5-02	Motor Acceleration Time	s	0.062	0.044	0.080	0.090	0.067	0.072	0.088	0.073
n8-49	d-Axis Cur for High Efficiency Cont	%	-8.8	-9.9	-9.3	-10.0	-17.7	-12.3	-15.3	-13.9

\*1 Default settings vary depending on the setting of o2-04 (Drive Model Selection).

**Table 10.17 SSR1 Series Motor Code Setting for Specification of 200 V at 1150 min<sup>-1</sup> (r/min)**

No.	Name	Unit	Motor Code (setting value of E5-01)							
E5-01	PM Motor Code Selection	-	140E	140F	1410	1412	1413	1414		
	Voltage Class	V	200	200	200	200	200	200	200	
	Capacity	kW	15	18	22	30	37	45		
	Motor Rotation Speed	min <sup>-1</sup>	1150	1150	1150	1150	1150	1150	1150	
E5-02	PM Motor Rated Power (kW)	kW	15	18.50	22.00	30.00	37.00	45.00		
E5-03	PM Motor Rated Current (FLA)	A	55.6	63.5	74.4	104.2	129.6	154.2		
E5-04	PM Motor Pole Count	-	6	6	6	6	6	6		
E5-05	PM Motor Resistance (ohms/phase)	Ω	0.084	0.066	0.048	0.035	0.023	0.016		
E5-06	PM d-axis Inductance (mH/phase)	mH	3.83	3.33	2.38	2.04	1.53	1.16		
E5-07	PM q-axis Inductance (mH/phase)	mH	4.65	4.50	3.15	2.86	2.27	1.54		
E5-09	PM Back-EMF V <sub>peak</sub> (mV/(rad/s))	mVs/rad	372.1	421.3	410.9	436.1	428.8	433.3		
E5-24	PM Motor Induced Voltage Constant 2 (Ke)	mV/(r/min)	0.0	0.0	0.0	0.0	0.0	0.0		
E1-04	Maximum Output Frequency	Hz	57.5	57.5	57.5	57.5	57.5	57.5	57.5	
E1-05	Maximum Output Voltage	V	190.0	190.0	190.0	190.0	190.0	190.0	190.0	
E1-06	Base Frequency	Hz	57.5	57.5	57.5	57.5	57.5	57.5	57.5	
E1-09	Minimum Output Frequency	Hz	2.9	2.9	2.9	2.9	2.9	2.9	2.9	
C5-17	Motor Inertia	kgm <sup>2</sup>	0.064	0.116	0.140	0.259	0.312	0.418		
L3-24 *1	Motor Accel Time for Inertia Cal	s	0.062	0.091	0.092	0.125	0.122	0.135		
n5-02	Motor Acceleration Time	s	0.062	0.091	0.092	0.125	0.122	0.135		
n8-49	d-Axis Cur for High Efficiency Cont	%	-14.4	-17.9	-15.9	-17.9	-20.1	-13.7		

\*1 Default settings vary depending on the setting of o2-04 (Drive Model Selection).

## 10.22 Parameters Changed by PM Motor Code Selection

**Table 10.18 SSR1 Series Motor Code Setting for Specification of 400 V at 1150 min<sup>-1</sup> (r/min)**

No.	Name	Unit	Motor Code (setting value of E5-01)							
			1432	1433	1435	1436	1438	143A	143B	143D
E5-01	PM Motor Code Selection	-	1432	1433	1435	1436	1438	143A	143B	143D
	Voltage Class	V	400	400	400	400	400	400	400	400
	Capacity	kW	0.4	0.75	1.5	2.2	3.7	5.5	7.5	11
	Motor Rotation Speed	min <sup>-1</sup>	1150	1150	1150	1150	1150	1150	1150	1150
E5-02	PM Motor Rated Power (kW)	kW	0.4	0.75	1.5	2.2	3.7	5.5	7.5	11.0
E5-03	PM Motor Rated Current (FLA)	A	0.94	1.51	3.00	4.43	7.08	10.10	13.33	19.9
E5-04	PM Motor Pole Count	-	6	6	6	6	6	6	6	6
E5-05	PM Motor Resistance (ohms/phase)	Ω	19.320	10.800	4.456	2.044	1.483	1.215	0.660	0.443
E5-06	PM d-axis Inductance (mH/phase)	mH	194.70	129.20	76.88	48.60	37.58	44.54	26.36	19.10
E5-07	PM q-axis Inductance (mH/phase)	mH	252.84	160.90	97.52	61.40	47.65	56.26	34.20	24.67
E5-09	PM Back-EMF V <sub>peak</sub> (mV/(rad/s))	mVs/rad	640.9	654.1	728.8	688.9	702.0	861.5	783.0	762.2
E5-24	PM Motor Induced Voltage Constant 2 (Ke)	mV/(r/min)	0.0	0.0	0.0	0.0	0.0	0.0	0.0	0.0
E1-04	Maximum Output Frequency	Hz	57.5	57.5	57.5	57.5	57.5	57.5	57.5	57.5
E1-05	Maximum Output Voltage	V	380.0	380.0	380.0	380.0	380.0	380.0	380.0	380.0
E1-06	Base Frequency	Hz	57.5	57.5	57.5	57.5	57.5	57.5	57.5	57.5
E1-09	Minimum Output Frequency	Hz	2.9	2.9	2.9	2.9	2.9	2.9	2.9	2.9
C5-17	Motor Inertia	kgm <sup>2</sup>	0.0017	0.0023	0.0083	0.0136	0.0171	0.027	0.046	0.055
L3-24 *1	Motor Accel Time for Inertia Cal	s	0.062	0.044	0.080	0.090	0.067	0.072	0.088	0.073
n5-02	Motor Acceleration Time	s	0.062	0.044	0.080	0.090	0.067	0.072	0.088	0.073
n8-49	d-Axis Cur for High Efficiency Cont	%	-8.8	-9.9	-9.3	-10.0	-12.8	-12.3	-15.3	-16.7

\*1 Default settings vary depending on the setting of o2-04 (Drive Model Selection).

**Table 10.19 SSR1 Series Motor Code Setting for Specification of 400 V at 1150 min<sup>-1</sup> (r/min)**

No.	Name	Unit	Motor Code (setting value of E5-01)					
			143E	143F	1440	1442	1443	1444
E5-01	PM Motor Code Selection	-	143E	143F	1440	1442	1443	1444
	Voltage Class	V	400	400	400	400	400	400
	Capacity	kW	15	18	22	30	37	45
	Motor Rotation Speed	min <sup>-1</sup>	1150	1150	1150	1150	1150	1150
E5-02	PM Motor Rated Power (kW)	kW	15	18.50	22.00	30.00	37.00	45.00
E5-03	PM Motor Rated Current (FLA)	A	27.8	31.8	37.2	52.1	64.8	76.6

No.	Name	Unit	Motor Code (setting value of E5-01)					
E5-04	PM Motor Pole Count	-	6	6	6	6	6	6
E5-05	PM Motor Resistance (ohms/phase)	$\Omega$	0.331	0.264	0.192	0.140	0.093	0.063
E5-06	PM d-axis Inductance (mH/phase)	mH	15.09	13.32	9.52	8.16	6.13	4.63
E5-07	PM q-axis Inductance (mH/phase)	mH	18.56	18.00	12.60	11.40	9.10	6.15
E5-09	PM Back-EMF Vpeak (mV/(rad/s))	mVs/rad	749.6	842.7	821.8	872.3	857.7	866.6
E5-24	PM Motor Induced Voltage Constant 2 (Ke)	mV/(r/min)	0.0	0.0	0.0	0.0	0.0	0.0
E1-04	Maximum Output Frequency	Hz	57.5	57.5	57.5	57.5	57.5	57.5
E1-05	Maximum Output Voltage	V	380.0	380.0	380.0	380.0	380.0	380.0
E1-06	Base Frequency	Hz	57.5	57.5	57.5	57.5	57.5	57.5
E1-09	Minimum Output Frequency	Hz	2.9	2.9	2.9	2.9	2.9	2.9
C5-17	Motor Inertia	kgm <sup>2</sup>	0.064	0.116	0.140	0.259	0.312	0.418
L3-24 */	Motor Accel Time for Inertia Cal	s	0.062	0.091	0.092	0.125	0.122	0.135
n5-02	Motor Acceleration Time	s	0.062	0.091	0.092	0.125	0.122	0.135
n8-49	d-Axis Cur forHighEfficiencyCont	%	-14.9	-17.9	-15.9	-17.7	-20.1	-13.8

\*1 Default settings vary depending on the setting of o2-04 (Drive Model Selection).

**Table 10.20 SSR1 Series Motor Code Setting for Specification of 400 V at 1150 min<sup>-1</sup> (r/min)**

No.	Name	Unit	Motor Code (setting value of E5-01)			
E5-01	PM Motor Code Selection	-	1445	1446	1447	1448
	Voltage Class	V	400	400	400	400
	Capacity	kW	55	75	90	110
	Motor Rotation Speed	min <sup>-1</sup>	1150	1150	1150	1150
E5-02	PM Motor Rated Power (kW)	kW	55.00	75.00	90.00	110.00
E5-03	PM Motor Rated Current (FLA)	A	92.0	127.1	150.5	185.4
E5-04	PM Motor Pole Count	-	6	6	6	6
E5-05	PM Motor Resistance (ohms/phase)	$\Omega$	0.051	0.033	0.027	0.015
E5-06	PM d-axis Inductance (mH/phase)	mH	3.96	3.03	2.60	1.89
E5-07	PM q-axis Inductance (mH/phase)	mH	5.00	5.14	3.28	2.33
E5-09	PM Back-EMF Vpeak (mV/(rad/s))	mVs/rad	854.0	823.1	853.4	829.2
E5-24	PM Motor Induced Voltage Constant 2 (Ke)	mV/(r/min)	0.0	0.0	0.0	0.0
E1-04	Maximum Output Frequency	Hz	57.5	57.5	57.5	57.5
E1-05	Maximum Output Voltage	V	380.0	380.0	380.0	380.0

## 10.22 Parameters Changed by PM Motor Code Selection

No.	Name	Unit	Motor Code (setting value of E5-01)			
E1-06	Base Frequency	Hz	57.5	57.5	57.5	57.5
E1-09	Minimum Output Frequency	Hz	2.9	2.9	2.9	2.9
C5-17	Motor Inertia	kgm <sup>2</sup>	0.56	0.83	0.96	1.61
L3-24 *1	Motor Accel Time for Inertia Cal	s	0.147	0.161	0.154	0.212
n5-02	Motor Acceleration Time	s	0.147	0.161	0.154	0.212
n8-49	d-Axis Cur forHighEfficiencyCont	%	-12.5	-28.8	-13.3	-11.6

\*1 Default settings vary depending on the setting of o2-04 [Drive Model Selection].

### ◆ Yaskawa SST4 Series IPM Motors (Constant Torque)

Table 10.21 SST4 Series Motor Code Setting for Specification of 200 V at 1750 min<sup>-1</sup> (r/min)

No.	Name	Unit	Motor Code (setting value of E5-01)							
E5-01	PM Motor Code Selection	-	2202	2203	2205	2206	2208	220A	220B	220D
	Voltage Class	V	200	200	200	200	200	200	200	200
	Capacity	kW	0.4	0.75	1.5	2.2	3.7	5.5	7.5	11
	Motor Rotation Speed	min <sup>-1</sup>	1750	1750	1750	1750	1750	1750	1750	1750
E5-02	PM Motor Rated Power (kW)	kW	0.4	0.75	1.5	2.2	3.7	5.5	7.5	11.0
E5-03	PM Motor Rated Current (FLA)	A	1.77	3.54	6.56	8.96	14.79	20.94	29.58	41.1
E5-04	PM Motor Pole Count	-	6	6	6	6	6	6	6	6
E5-05	PM Motor Resistance (ohms/phase)	Ω	2.247	1.132	0.774	0.479	0.242	0.275	0.161	0.111
E5-06	PM d-axis Inductance (mH/phase)	mH	22.32	12.38	8.90	7.39	5.06	5.82	3.86	3.59
E5-07	PM q-axis Inductance (mH/phase)	mH	32.50	15.72	11.96	9.63	6.42	6.74	4.66	4.32
E5-09	PM Back-EMF V <sub>peak</sub> (mV/(rad/s))	mVs/rad	215.2	203.9	219.3	230.6	235.1	251.7	235.7	252.0
E5-24	PM Motor Induced Voltage Constant 2 (Ke)	mV/(r/min)	0.0	0.0	0.0	0.0	0.0	0.0	0.0	0.0
E1-04	Maximum Output Frequency	Hz	87.5	87.5	87.5	87.5	87.5	87.5	87.5	87.5
E1-05	Maximum Output Voltage	V	190.0	190.0	190.0	190.0	190.0	190.0	190.0	190.0
E1-06	Base Frequency	Hz	87.5	87.5	87.5	87.5	87.5	87.5	87.5	87.5
E1-09	Minimum Output Frequency	Hz	4.4	4.4	4.4	4.4	4.4	4.4	4.4	4.4
C5-17	Motor Inertia	kgm <sup>2</sup>	0.0016	0.0022	0.0042	0.0081	0.0133	0.013	0.017	0.027
L3-24 *1	Motor Accel Time for Inertia Cal	s	0.134	0.099	0.094	0.124	0.121	0.081	0.075	0.082

No.	Name	Unit	Motor Code (setting value of E5-01)							
n5-02	Motor Acceleration Time	s	0.134	0.099	0.094	0.124	0.121	0.081	0.075	0.082
n8-49	d-Axis Cur for High Efficiency Cont	%	-9.3	-6.4	-10.0	-9.9	-9.7	-8.4	-11.5	-13.1

\*1 Default settings vary depending on the setting of o2-04 (Drive Model Selection).

**Table 10.22 SST4 Series Motor Code Setting for Specification of 200 V at 1750 min<sup>-1</sup> (r/min)**

No.	Name	Unit	Motor Code (setting value of E5-01)							
E5-01	PM Motor Code Selection	-	220E	220F	2210	2212	2213	2214	2215	2216
	Voltage Class	V	200	200	200	200	200	200	200	200
	Capacity	kW	15	18	22	30	37	45	55	75
	Motor Rotation Speed	min <sup>-1</sup>	1750	1750	1750	1750	1750	1750	1750	1750
E5-02	PM Motor Rated Power (kW)	kW	15	18.50	22.00	30.00	37.00	45.00	55.00	75.00
E5-03	PM Motor Rated Current (FLA)	A	54.2	68.2	78.6	104.2	129.2	153.1	205.2	260.4
E5-04	PM Motor Pole Count	-	6	6	6	6	6	6	6	6
E5-05	PM Motor Resistance (ohms/phase)	Ω	0.071	0.049	0.040	0.030	0.020	0.013	0.009	0.006
E5-06	PM d-axis Inductance (mH/phase)	mH	2.67	1.98	1.69	1.31	0.88	0.77	0.55	0.40
E5-07	PM q-axis Inductance (mH/phase)	mH	3.10	2.41	2.12	1.61	1.14	1.04	0.69	0.50
E5-09	PM Back-EMF V <sub>peak</sub> (mV/(rad/s))	mVs/rad	253.7	244.6	256.3	283.1	266.3	260.0	261.5	259.3
E5-24	PM Motor Induced Voltage Constant 2 (Ke)	mV/(r/min)	0.0	0.0	0.0	0.0	0.0	0.0	0.0	0.0
E1-04	Maximum Output Frequency	Hz	87.5	87.5	87.5	87.5	87.5	87.5	87.5	87.5
E1-05	Maximum Output Voltage	V	190.0	190.0	190.0	190.0	190.0	190.0	190.0	190.0
E1-06	Base Frequency	Hz	87.5	87.5	87.5	87.5	87.5	87.5	87.5	87.5
E1-09	Minimum Output Frequency	Hz	4.4	4.4	4.4	4.4	4.4	4.4	4.4	4.4
C5-17	Motor Inertia	kgm <sup>2</sup>	0.044	0.054	0.063	0.113	0.137	0.252	0.30	0.41
L3-24 *1	Motor Accel Time for Inertia Cal	s	0.099	0.098	0.096	0.126	0.124	0.188	0.186	0.184
n5-02	Motor Acceleration Time	s	0.099	0.098	0.096	0.126	0.124	0.188	0.186	0.184
n8-49	d-Axis Cur for High Efficiency Cont	%	-10.9	-14.3	-15.1	-11.3	-14.1	-18.8	-11.4	-12.2

\*1 Default settings vary depending on the setting of o2-04 (Drive Model Selection).

## 10.22 Parameters Changed by PM Motor Code Selection

**Table 10.23 SST4 Series Motor Code Setting for Specification of 400 V at 1750 min<sup>-1</sup> (r/min)**

No.	Name	Unit	Motor Code (setting value of E5-01)							
			2232	2233	2235	2236	2238	223A	223B	223D
E5-01	PM Motor Code Selection	-	2232	2233	2235	2236	2238	223A	223B	223D
	Voltage Class	V	400	400	400	400	400	400	400	400
	Capacity	kW	0.4	0.75	1.5	2.2	3.7	5.5	7.5	11
	Motor Rotation Speed	min <sup>-1</sup>	1750	1750	1750	1750	1750	1750	1750	1750
E5-02	PM Motor Rated Power (kW)	kW	0.4	0.75	1.5	2.2	3.7	5.5	7.5	11.0
E5-03	PM Motor Rated Current (FLA)	A	0.92	1.77	3.33	4.48	7.50	10.42	14.27	20.5
E5-04	PM Motor Pole Count	-	6	6	6	6	6	6	6	6
E5-05	PM Motor Resistance (ohms/phase)	Ω	8.935	4.570	3.096	1.906	0.972	1.103	0.630	0.429
E5-06	PM d-axis Inductance (mH/phase)	mH	80.14	48.04	35.60	30.31	20.03	23.41	14.86	14.34
E5-07	PM q-axis Inductance (mH/phase)	mH	110.76	64.88	47.84	38.36	24.97	28.70	17.25	17.25
E5-09	PM Back-EMF V <sub>peak</sub> (mV/(rad/s))	mVs/rad	416.5	399.4	438.5	475.5	463.7	485.8	470.4	513.4
E5-24	PM Motor Induced Voltage Constant 2 (Ke)	mV/(r/min)	0.0	0.0	0.0	0.0	0.0	0.0	0.0	0.0
E1-04	Maximum Output Frequency	Hz	87.5	87.5	87.5	87.5	87.5	87.5	87.5	87.5
E1-05	Maximum Output Voltage	V	380.0	380.0	380.0	380.0	380.0	380.0	380.0	380.0
E1-06	Base Frequency	Hz	87.5	87.5	87.5	87.5	87.5	87.5	87.5	87.5
E1-09	Minimum Output Frequency	Hz	4.4	4.4	4.4	4.4	4.4	4.4	4.4	4.4
C5-17	Motor Inertia	kgm <sup>2</sup>	0.0016	0.0022	0.0042	0.0081	0.0133	0.013	0.017	0.027
L3-24 *1	Motor Accel Time for Inertia Cal	s	0.134	0.099	0.094	0.124	0.121	0.081	0.075	0.082
n5-02	Motor Acceleration Time	s	0.134	0.099	0.094	0.124	0.121	0.081	0.075	0.082
n8-49	d-Axis Cur for High Efficiency Cont	%	-7.5	-8.5	-9.8	-8.2	-9.1	-13.1	-9.2	-12.4

\*1 Default settings vary depending on the setting of o2-04 (Drive Model Selection).

**Table 10.24 SST4 Series Motor Code Setting for Specification of 400 V at 1750 min<sup>-1</sup> (r/min)**

No.	Name	Unit	Motor Code (setting value of E5-01)							
			223E	223F	2240	2242	2243	2244	2245	2246
E5-01	PM Motor Code Selection	-	223E	223F	2240	2242	2243	2244	2245	2246
	Voltage Class	V	400	400	400	400	400	400	400	400
	Capacity	kW	15	18	22	30	37	45	55	75
	Motor Rotation Speed	min <sup>-1</sup>	1750	1750	1750	1750	1750	1750	1750	1750
E5-02	PM Motor Rated Power (kW)	kW	15	18.50	22.00	30.00	37.00	45.00	55.00	75.00

No.	Name	Unit	Motor Code (setting value of E5-01)							
E5-03	PM Motor Rated Current (FLA)	A	26.4	34.2	38.8	52.2	65.4	77.6	99.3	130.2
E5-04	PM Motor Pole Count	-	6	6	6	6	6	6	6	6
E5-05	PM Motor Resistance (ohms/phase)	Ω	0.275	0.196	0.160	0.120	0.077	0.052	0.036	0.023
E5-06	PM d-axis Inductance (mH/phase)	mH	9.99	7.92	6.82	5.24	3.57	2.98	1.59	1.59
E5-07	PM q-axis Inductance (mH/phase)	mH	12.37	9.64	8.51	6.44	4.65	3.75	2.78	1.97
E5-09	PM Back-EMF Vpeak (mV/(rad/s))	mVs/rad	505.3	489.2	509.5	566.2	531.6	530.6	515.2	515.2
E5-24	PM Motor Induced Voltage Constant 2 (Ke)	mV/(r/min)	0.0	0.0	0.0	0.0	0.0	0.0	0.0	0.0
E1-04	Maximum Output Frequency	Hz	87.5	87.5	87.5	87.5	87.5	87.5	87.5	87.5
E1-05	Maximum Output Voltage	V	380.0	380.0	380.0	380.0	380.0	380.0	380.0	380.0
E1-06	Base Frequency	Hz	87.5	87.5	87.5	87.5	87.5	87.5	87.5	87.5
E1-09	Minimum Output Frequency	Hz	4.4	4.4	4.4	4.4	4.4	4.4	4.4	4.4
C5-17	Motor Inertia	kgm <sup>2</sup>	0.044	0.054	0.063	0.113	0.137	0.252	0.30	0.41
L3-24 */	Motor Accel Time for Inertia Cal	s	0.099	0.098	0.096	0.126	0.124	0.188	0.186	0.184
n5-02	Motor Acceleration Time	s	0.099	0.098	0.096	0.126	0.124	0.188	0.186	0.184
n8-49	d-Axis Cur for High Efficiency Cont	%	-15.1	-14.3	-15.3	-11.3	-14.5	-13.2	-22.6	-11.9

\*1 Default settings vary depending on the setting of o2-04 (Drive Model Selection).

**Table 10.25 SST4 Series Motor Code Setting for Specification of 400 V at 1750 min<sup>-1</sup> (r/min)**

No.	Name	Unit	Motor Code (setting value of E5-01)							
E5-01	PM Motor Code Selection	-	2247	2248	2249	224A	224C	224D	224E	
	Voltage Class	V	400	400	400	400	400	400	400	
	Capacity	kW	90	110	132	160	200	220	300	
	Motor Rotation Speed	min <sup>-1</sup>	1750	1750	1750	1750	1750	1750	1750	
E5-02	PM Motor Rated Power (kW)	kW	90.00	110.00	132.00	160.00	200.00	250.00	300.00	
E5-03	PM Motor Rated Current (FLA)	A	153.1	184.4	229.2	269.8	346.9	421.9	520.8	
E5-04	PM Motor Pole Count	-	6	6	6	6	6	6	6	
E5-05	PM Motor Resistance (ohms/phase)	Ω	0.019	0.017	0.012	0.008	0.005	0.004	0.002	
E5-06	PM d-axis Inductance (mH/phase)	mH	1.51	1.43	1.13	0.96	0.65	0.67	0.40	

## 10.22 Parameters Changed by PM Motor Code Selection

No.	Name	Unit	Motor Code (setting value of E5-01)						
E5-07	PM q-axis Inductance (mH/phase)	mH	1.76	1.92	1.54	1.26	0.88	0.74	0.52
E5-09	PM Back-EMF Vpeak (mV/(rad/s))	mVs/rad	538.3	590.9	548.2	603.9	556.8	593.1	495.4
E5-24	PM Motor Induced Voltage Constant 2 (Ke)	mV/(r/min)	0.0	0.0	0.0	0.0	0.0	0.0	0.0
E1-04	Maximum Output Frequency	Hz	87.5	87.5	87.5	87.5	87.5	87.5	87.5
E1-05	Maximum Output Voltage	V	380.0	380.0	380.0	380.0	380.0	380.0	380.0
E1-06	Base Frequency	Hz	87.5	87.5	87.5	87.5	87.5	87.5	87.5
E1-09	Minimum Output Frequency	Hz	4.4	4.4	4.4	4.4	4.4	4.4	4.4
C5-17	Motor Inertia	kgm <sup>2</sup>	0.55	0.82	0.96	1.60	1.95	2.82	3.70
L3-24 *1	Motor Accel Time for Inertia Cal	s	0.205	0.250	0.244	0.336	0.327	0.379	0.414
n5-02	Motor Acceleration Time	s	0.205	0.250	0.244	0.336	0.327	0.379	0.414
n8-49	d-Axis Cur forHighEfficiency Cont	%	-8.6	-14.8	-17.5	-12.5	-14.7	-5.1	-16.3

\*1 Default settings vary depending on the setting of o2-04 (Drive Model Selection).

**Table 10.26 SST4 Series Motor Code Setting for Specification of 200 V at 1450 min<sup>-1</sup> (r/min)**

No.	Name	Unit	Motor Code (setting value of E5-01)							
E5-01	PM Motor Code Selection	-	2302	2303	2305	2306	2308	230A	230B	230D
	Voltage Class	V	200	200	200	200	200	200	200	200
	Capacity	kW	0.4	0.75	1.5	2.2	3.7	5.5	7.5	11
	Motor Rotation Speed	min <sup>-1</sup>	1450	1450	1450	1450	1450	1450	1450	1450
E5-02	PM Motor Rated Power (kW)	kW	0.4	0.75	1.5	2.2	3.7	5.5	7.5	11.0
E5-03	PM Motor Rated Current (FLA)	A	1.77	3.33	5.94	9.48	14.17	20.42	27.92	39.6
E5-04	PM Motor Pole Count	-	6	6	6	6	6	6	6	6
E5-05	PM Motor Resistance (ohms/phase)	Ω	3.154	1.835	0.681	0.308	0.405	0.278	0.180	0.098
E5-06	PM d-axis Inductance (mH/phase)	mH	28.46	19.46	10.00	6.88	8.15	5.77	6.32	3.34
E5-07	PM q-axis Inductance (mH/phase)	mH	39.29	25.89	15.20	9.25	10.76	8.60	8.80	4.61
E5-09	PM Back-EMF Vpeak (mV/(rad/s))	mVs/rad	268.8	256.9	271.9	260.2	286.8	314.9	300.8	292.3
E5-24	PM Motor Induced Voltage Constant 2 (Ke)	mV/(r/min)	0.0	0.0	0.0	0.0	0.0	0.0	0.0	0.0
E1-04	Maximum Output Frequency	Hz	72.5	72.5	72.5	72.5	72.5	72.5	72.5	72.5



No.	Name	Unit	Motor Code (setting value of E5-01)							
E1-05	Maximum Output Voltage	V	190.0	190.0	190.0	190.0	190.0	190.0	190.0	190.0
E1-06	Base Frequency	Hz	72.5	72.5	72.5	72.5	72.5	72.5	72.5	72.5
E1-09	Minimum Output Frequency	Hz	3.6	3.6	3.6	3.6	3.6	3.6	3.6	3.6
C5-17	Motor Inertia	kgm <sup>2</sup>	0.0016	0.0022	0.0081	0.0133	0.0133	0.017	0.027	0.044
L3-24 */	Motor Accel Time for Inertia Cal	s	0.092	0.068	0.125	0.139	0.083	0.070	0.082	0.092
n5-02	Motor Acceleration Time	s	0.092	0.068	0.125	0.139	0.083	0.070	0.082	0.092
n8-49	d-Axis Cur for High Efficiency Cont	%	-7.5	-9.4	-13.9	-10.0	-15.0	-17.9	-22.7	-20.5

\*1 Default settings vary depending on the setting of o2-04 (Drive Model Selection).

**Table 10.27 SST4 Series Motor Code Setting for Specification of 200 V at 1450 min<sup>-1</sup> (r/min)**

No.	Name	Unit	Motor Code (setting value of E5-01)							
E5-01	PM Motor Code Selection	-	230E	230F	2310	2312	2313	2314	2315	2316
	Voltage Class	V	200	200	200	200	200	200	200	200
	Capacity	kW	15	18	22	30	37	45	55	75
	Motor Rotation Speed	min <sup>-1</sup>	1450	1450	1450	1450	1450	1450	1450	1450
E5-02	PM Motor Rated Power (kW)	kW	15.0	18.50	22.00	30.00	37.00	45.00	55.00	75.00
E5-03	PM Motor Rated Current (FLA)	A	54.2	68.3	75.2	102.0	131.3	160.4	191.7	257.3
E5-04	PM Motor Pole Count	-	6	6	6	6	6	6	6	6
E5-05	PM Motor Resistance (ohms/phase)	Ω	0.073	0.055	0.048	0.034	0.023	0.016	0.012	0.007
E5-06	PM d-axis Inductance (mH/phase)	mH	2.94	2.23	2.08	1.67	1.39	0.94	0.82	0.56
E5-07	PM q-axis Inductance (mH/phase)	mH	3.65	2.85	2.66	2.04	1.73	1.22	1.06	0.76
E5-09	PM Back-EMF V <sub>peak</sub> (mV/(rad/s))	mVs/rad	305.1	297.6	355.8	355.4	324.0	302.4	337.2	323.4
E5-24	PM Motor Induced Voltage Constant 2 (Ke)	mV/(r/min)	0.0	0.0	0.0	0.0	0.0	0.0	0.0	0.0
E1-04	Maximum Output Frequency	Hz	72.5	72.5	72.5	72.5	72.5	72.5	72.5	72.5
E1-05	Maximum Output Voltage	V	190.0	190.0	190.0	190.0	190.0	190.0	190.0	190.0
E1-06	Base Frequency	Hz	72.5	72.5	72.5	72.5	72.5	72.5	72.5	72.5
E1-09	Minimum Output Frequency	Hz	3.6	3.6	3.6	3.6	3.6	3.6	3.6	3.6
C5-17	Motor Inertia	kgm <sup>2</sup>	0.054	0.063	0.113	0.137	0.252	0.304	0.41	0.55
L3-24 */	Motor Accel Time for Inertia Cal	s	0.083	0.079	0.118	0.105	0.157	0.156	0.172	0.169

## 10.22 Parameters Changed by PM Motor Code Selection

No.	Name	Unit	Motor Code (setting value of E5-01)							
n5-02	Motor Acceleration Time	s	0.083	0.079	0.118	0.105	0.157	0.156	0.172	0.169
n8-49	d-Axis Cur forHighEfficiency Cont	%	-14.6	-16.4	-11.8	-10.5	-14.5	-17.4	-13.8	-17.5

\*1 Default settings vary depending on the setting of o2-04 (Drive Model Selection).

**Table 10.28 SST4 Series Motor Code Setting for Specification of 400 V at 1450 min<sup>-1</sup> (r/min)**

No.	Name	Unit	Motor Code (setting value of E5-01)							
E5-01	PM Motor Code Selection	-	2332	2333	2335	2336	2338	233A	233B	233D
	Voltage Class	V	400	400	400	400	400	400	400	400
	Capacity	kW	0.4	0.75	1.5	2.2	3.7	5.5	7.5	11
	Motor Rotation Speed	min <sup>-1</sup>	1450	1450	1450	1450	1450	1450	1450	1450
E5-02	PM Motor Rated Power (kW)	kW	0.4	0.75	1.5	2.2	3.7	5.5	7.5	11.0
E5-03	PM Motor Rated Current (FLA)	A	0.91	1.67	3.02	4.74	7.08	10.21	13.96	20.5
E5-04	PM Motor Pole Count	-	6	6	6	6	6	6	6	6
E5-05	PM Motor Resistance (ohms/phase)	Ω	12.616	7.340	2.724	1.232	1.509	1.112	0.720	0.393
E5-06	PM d-axis Inductance (mH/phase)	mH	113.84	77.84	40.00	27.52	31.73	23.09	25.28	13.36
E5-07	PM q-axis Inductance (mH/phase)	mH	157.16	103.56	60.80	37.00	40.88	34.39	35.20	18.44
E5-09	PM Back-EMF V <sub>peak</sub> (mV/(rad/s))	mVs/rad	490.8	513.8	543.7	520.3	580.8	602.7	601.5	584.6
E5-24	PM Motor Induced Voltage Constant 2 (Ke)	mV/(r/min)	0.0	0.0	0.0	0.0	0.0	0.0	0.0	0.0
E1-04	Maximum Output Frequency	Hz	72.5	72.5	72.5	72.5	72.5	72.5	72.5	72.5
E1-05	Maximum Output Voltage	V	380.0	380.0	380.0	380.0	380.0	380.0	380.0	380.0
E1-06	Base Frequency	Hz	72.5	72.5	72.5	72.5	72.5	72.5	72.5	72.5
E1-09	Minimum Output Frequency	Hz	3.6	3.6	3.6	3.6	3.6	3.6	3.6	3.6
C5-17	Motor Inertia	kgm <sup>2</sup>	0.0016	0.0022	0.0081	0.0133	0.0133	0.017	0.027	0.044
L3-24 */	Motor Accel Time for Inertia Cal	s	0.092	0.068	0.125	0.139	0.083	0.070	0.082	0.092
n5-02	Motor Acceleration Time	s	0.092	0.068	0.125	0.139	0.083	0.070	0.082	0.092
n8-49	d-Axis Cur forHighEfficiency Cont	%	-9.5	-9.4	-13.7	-10.0	-12.9	-19.9	-22.8	-19.8

\*1 Default settings vary depending on the setting of o2-04 (Drive Model Selection).

**Table 10.29 SST4 Series Motor Code Setting for Specification of 400 V at 1450 min<sup>-1</sup> (r/min)**

No.	Name	Unit	Motor Code (setting value of E5-01)							
			233E	233F	2340	2342	2343	2344	2345	2346
E5-01	PM Motor Code Selection	-	233E	233F	2340	2342	2343	2344	2345	2346
	Voltage Class	V	400	400	400	400	400	400	400	400
	Capacity	kW	15	18	22	30	37	45	55	75
	Motor Rotation Speed	min <sup>-1</sup>	1450	1450	1450	1450	1450	1450	1450	1450
E5-02	PM Motor Rated Power (kW)	kW	15	18.50	22.00	30.00	37.00	45.00	55.00	75.00
E5-03	PM Motor Rated Current (FLA)	A	27.1	34.2	37.6	50.9	65.4	80.2	96.1	129.2
E5-04	PM Motor Pole Count	-	6	6	6	6	6	6	6	6
E5-05	PM Motor Resistance (ohms/phase)	Ω	0.291	0.220	0.192	0.136	0.091	0.064	0.048	0.028
E5-06	PM d-axis Inductance (mH/phase)	mH	11.77	8.94	8.32	6.68	5.30	3.76	3.09	2.24
E5-07	PM q-axis Inductance (mH/phase)	mH	14.60	11.40	10.64	8.16	6.80	4.88	4.75	3.03
E5-09	PM Back-EMF V <sub>peak</sub> (mV/(rad/s))	mVs/rad/s)	610.3	595.2	711.6	710.8	652.7	604.8	669.1	646.8
E5-24	PM Motor Induced Voltage Constant 2 (Ke)	mV/(r/min)	0.0	0.0	0.0	0.0	0.0	0.0	0.0	0.0
E1-04	Maximum Output Frequency	Hz	72.5	72.5	72.5	72.5	72.5	72.5	72.5	72.5
E1-05	Maximum Output Voltage	V	380.0	380.0	380.0	380.0	380.0	380.0	380.0	380.0
E1-06	Base Frequency	Hz	72.5	72.5	72.5	72.5	72.5	72.5	72.5	72.5
E1-09	Minimum Output Frequency	Hz	3.6	3.6	3.6	3.6	3.6	3.6	3.6	3.6
C5-17	Motor Inertia	kgm <sup>2</sup>	0.054	0.063	0.113	0.137	0.252	0.304	0.41	0.55
L3-24 *1	Motor Accel Time for Inertia Cal	s	0.083	0.079	0.118	0.105	0.157	0.156	0.172	0.169
n5-02	Motor Acceleration Time	s	0.083	0.079	0.118	0.105	0.157	0.156	0.172	0.169
n8-49	d-Axis Cur for High Efficiency Cont	%	-14.5	-16.1	-11.8	-10.5	-15.6	-17.4	-21.7	-17.3

\*1 Default settings vary depending on the setting of o2-04 (Drive Model Selection).

**Table 10.30 SST4 Series Motor Code Setting for Specification of 400 V at 1450 min<sup>-1</sup> (r/min)**

No.	Name	Unit	Motor Code (setting value of E5-01)					
			2347	2348	2349	234A	234C	234D
E5-01	PM Motor Code Selection	-	2347	2348	2349	234A	234C	234D
	Voltage Class	V	400	400	400	400	400	400
	Capacity	kW	90	110	132	160	200	250
	Motor Rotation Speed	min <sup>-1</sup>	1450	1450	1450	1450	1450	1450
E5-02	PM Motor Rated Power (kW)	kW	90.00	110.00	132.00	160.00	200.00	250.00

## 10.22 Parameters Changed by PM Motor Code Selection

No.	Name	Unit	Motor Code (setting value of E5-01)					
E5-03	PM Motor Rated Current (FLA)	A	153.1	191.7	226.0	268.8	331.3	422.9
E5-04	PM Motor Pole Count	-	6	6	6	6	6	6
E5-05	PM Motor Resistance (ohms/phase)	Ω	0.024	0.015	0.011	0.007	0.006	0.003
E5-06	PM d-axis Inductance (mH/phase)	mH	2.20	1.34	1.23	0.92	0.84	0.61
E5-07	PM q-axis Inductance (mH/phase)	mH	3.23	2.16	1.67	1.30	1.25	0.89
E5-09	PM Back-EMF V <sub>peak</sub> (mV/(rad/s))	mVs/rad/s)	708.0	637.8	677.0	661.7	687.1	655.9
E5-24	PM Motor Induced Voltage Constant 2 (K <sub>e</sub> )	mV/(r/min)	0.0	0.0	0.0	0.0	0	0.0
E1-04	Maximum Output Frequency	Hz	72.5	72.5	72.5	72.5	72.5	72.5
E1-05	Maximum Output Voltage	V	380.0	380.0	380.0	380.0	380.0	380.0
E1-06	Base Frequency	Hz	72.5	72.5	72.5	72.5	72.5	72.5
E1-09	Minimum Output Frequency	Hz	3.6	3.6	3.6	3.6	3.6	3.6
C5-17	Motor Inertia	kgm <sup>2</sup>	0.82	0.96	1.60	1.95	2.82	3.70
L3-24 *1	Motor Accel Time for Inertia Cal	s	0.210	0.201	0.279	0.281	0.325	0.341
n5-02	Motor Acceleration Time	s	0.210	0.201	0.279	0.281	0.325	0.341
n8-49	d-Axis Cur for High Efficiency Cont	%	-19.6	-24.1	-15.1	-17.0	-19.8	-19.3

\*1 Default settings vary depending on the setting of o2-04 (Drive Model Selection).

**Table 10.31 SST4 Series Motor Code Setting for Specification of 200 V at 1150 min<sup>-1</sup> (r/min)**

No.	Name	Unit	Motor Code (setting value of E5-01)							
E5-01	PM Motor Code Selection	-	2402	2403	2405	2406	2408	240A	240B	240D
	Voltage Class	V	200	200	200	200	200	200	200	200
	Capacity	kW	0.4	0.75	1.5	2.2	3.7	5.5	7.5	11
	Motor Rotation Speed	min <sup>-1</sup>	1150	1150	1150	1150	1150	1150	1150	1150
E5-02	PM Motor Rated Power (kW)	kW	0.4	0.75	1.5	2.2	3.7	5.5	7.5	11.0
E5-03	PM Motor Rated Current (FLA)	A	1.77	3.44	5.94	9.17	14.79	20.21	27.40	39.0
E5-04	PM Motor Pole Count	-	6	6	6	6	6	6	6	6
E5-05	PM Motor Resistance (ohms/phase)	Ω	2.680	1.520	1.071	0.542	0.362	0.295	0.162	0.115
E5-06	PM d-axis Inductance (mH/phase)	mH	30.55	15.29	17.48	11.98	8.60	9.54	5.31	4.44

No.	Name	Unit	Motor Code (setting value of E5-01)							
E5-07	PM q-axis Inductance (mH/phase)	mH	42.71	24.28	22.51	15.51	10.69	13.84	8.26	5.68
E5-09	PM Back-EMF V <sub>peak</sub> (mV/(rad/s))	mVs/rad	313.1	313.1	345.3	342.9	363.8	384.3	379.9	370.2
E5-24	PM Motor Induced Voltage Constant 2 (Ke)	mV/(r/min)	0.0	0.0	0.0	0.0	0.0	0.0	0.0	0.0
E1-04	Maximum Output Frequency	Hz	57.5	57.5	57.5	57.5	57.5	57.5	57.5	57.5
E1-05	Maximum Output Voltage	V	190.0	190.0	190.0	190.0	190.0	190.0	190.0	190.0
E1-06	Base Frequency	Hz	57.5	57.5	57.5	57.5	57.5	57.5	57.5	57.5
E1-09	Minimum Output Frequency	Hz	2.9	2.9	2.9	2.9	2.9	2.9	2.9	2.9
C5-17	Motor Inertia	kgm <sup>2</sup>	0.0022	0.0042	0.0081	0.0133	0.0168	0.027	0.044	0.054
L3-24 */	Motor Accel Time for Inertia Cal	s	0.080	0.081	0.078	0.088	0.066	0.070	0.085	0.071
n5-02	Motor Acceleration Time	s	0.080	0.081	0.078	0.088	0.066	0.070	0.085	0.071
n8-49	d-Axis Cur for High Efficiency Cont	%	-8.4	-11.0	-10.7	-10.7	-9.4	-22.5	-22.2	-16.7

\*1 Default settings vary depending on the setting of o2-04 (Drive Model Selection).

**Table 10.32 SST4 Series Motor Code Setting for Specification of 200 V at 1150 min<sup>-1</sup> (r/min)**

No.	Name	Unit	Motor Code (setting value of E5-01)							
E5-01	PM Motor Code Selection	-	240E	240F	2410	2412	2413	2414	2415	2416
	Voltage Class	V	200	200	200	200	200	200	200	200
	Capacity	kW	15	18	22	30	37	45	55	75
	Motor Rotation Speed	min <sup>-1</sup>	1150	1150	1150	1150	1150	1150	1150	1150
E5-02	PM Motor Rated Power (kW)	kW	15	18.50	22.00	30.00	37.00	45.00	55.00	75.00
E5-03	PM Motor Rated Current (FLA)	A	55.9	65.4	77.0	103.5	126.0	153.1	188.5	260.4
E5-04	PM Motor Pole Count	-	6	6	6	6	6	6	6	6
E5-05	PM Motor Resistance (ohms/phase)	Ω	0.083	0.065	0.052	0.035	0.026	0.019	0.013	0.009
E5-06	PM d-axis Inductance (mH/phase)	mH	3.50	2.92	2.55	2.03	1.59	1.24	0.98	0.70
E5-07	PM q-axis Inductance (mH/phase)	mH	4.23	3.79	3.22	2.46	1.92	1.64	1.37	0.97
E5-09	PM Back-EMF V <sub>peak</sub> (mV/(rad/s))	mVs/rad	364.5	404.5	445.1	444.4	447.3	470.8	422.4	418.3
E5-24	PM Motor Induced Voltage Constant 2 (Ke)	mV/(r/min)	0.0	0.0	0.0	0.0	0.0	0.0	0.0	0.0
E1-04	Maximum Output Frequency	Hz	57.5	57.5	57.5	57.5	57.5	57.5	57.5	57.5

## 10.22 Parameters Changed by PM Motor Code Selection

No.	Name	Unit	Motor Code (setting value of E5-01)							
E1-05	Maximum Output Voltage	V	190.0	190.0	190.0	190.0	190.0	190.0	190.0	190.0
E1-06	Base Frequency	Hz	57.5	57.5	57.5	57.5	57.5	57.5	57.5	57.5
E1-09	Minimum Output Frequency	Hz	2.9	2.9	2.9	2.9	2.9	2.9	2.9	2.9
C5-17	Motor Inertia	kgm <sup>2</sup>	0.063	0.113	0.137	0.252	0.304	0.410	0.55	0.82
L3-24 */	Motor Accel Time for Inertia Cal	s	0.061	0.089	0.090	0.122	0.119	0.132	0.145	0.159
n5-02	Motor Acceleration Time	s	0.061	0.089	0.090	0.122	0.119	0.132	0.145	0.159
n8-49	d-Axis Cur for High Efficiency Cont	%	-13.7	-15.2	-10.9	-9.8	-9.3	-11.5	-17.7	-17.1

\*1 Default settings vary depending on the setting of o2-04 (Drive Model Selection).

**Table 10.33 SST4 Series Motor Code Setting for Specification of 400 V at 1150 min<sup>-1</sup> (r/min)**

No.	Name	Unit	Motor Code (setting value of E5-01)							
E5-01	PM Motor Code Selection	-	2432	2433	2435	2436	2438	243A	243B	
	Voltage Class	V	400	400	400	400	400	400	400	
	Capacity	kW	0.4	0.75	1.5	2.2	3.7	5.5	7.5	
	Motor Rotation Speed	min <sup>-1</sup>	1150	1150	1150	1150	1150	1150	1150	
E5-02	PM Motor Rated Power (kW)	kW	0.4	0.75	1.5	2.2	3.7	5.5	7.5	
E5-03	PM Motor Rated Current (FLA)	A	0.89	1.72	3.02	4.58	7.40	10.21	13.75	
E5-04	PM Motor Pole Count	-	6	6	6	6	6	6	6	
E5-05	PM Motor Resistance (ohms/phase)	Ω	10.720	6.080	4.336	2.143	1.428	1.199	0.648	
E5-06	PM d-axis Inductance (mH/phase)	mH	122.20	61.16	70.24	46.20	33.87	41.67	21.24	
E5-07	PM q-axis Inductance (mH/phase)	mH	170.80	97.12	90.04	60.28	42.98	69.15	33.04	
E5-09	PM Back-EMF V <sub>peak</sub> (mV/(rad/s))	mVs/rad	626.1	626.1	703.1	727.6	699.0	861.5	759.7	
E5-24	PM Motor Induced Voltage Constant 2 (K <sub>e</sub> )	mV/(r/min)	0.0	0.0	0.0	0.0	0.0	0.0	0.0	
E1-04	Maximum Output Frequency	Hz	57.5	57.5	57.5	57.5	57.5	57.5	57.5	
E1-05	Maximum Output Voltage	V	380.0	380.0	380.0	380.0	380.0	380.0	380.0	
E1-06	Base Frequency	Hz	57.5	57.5	57.5	57.5	57.5	57.5	57.5	
E1-09	Minimum Output Frequency	Hz	2.9	2.9	2.9	2.9	2.9	2.9	2.9	
C5-17	Motor Inertia	kgm <sup>2</sup>	0.0022	0.0042	0.0081	0.0133	0.0168	0.027	0.044	
L3-24 */	Motor Accel Time for Inertia Cal	s	0.080	0.081	0.078	0.088	0.066	0.070	0.085	

No.	Name	Unit	Motor Code (setting value of E5-01)						
n5-02	Motor Acceleration Time	s	0.080	0.081	0.078	0.088	0.066	0.070	0.085
n8-49	d-Axis Cur for High Efficiency Cont	%	-8.4	-11.0	-9.9	-9.0	-11.4	-23.2	-22.1

\*1 Default settings vary depending on the setting of o2-04 (Drive Model Selection).

**Table 10.34 SST4 Series Motor Code Setting for Specification of 400 V at 1150 min<sup>-1</sup> (r/min)**

No.	Name	Unit	Motor Code (setting value of E5-01)						
E5-01	PM Motor Code Selection	-	243D	243E	243F	2440	2442	2443	2444
	Voltage Class	V	400	400	400	400	400	400	400
	Capacity	kW	11	15	18	22	30	37	45
	Motor Rotation Speed	min <sup>-1</sup>	1150	1150	1150	1150	1150	1150	1150
E5-02	PM Motor Rated Power (kW)	kW	11.0	15	18.50	22.00	30.00	37.00	45.00
E5-03	PM Motor Rated Current (FLA)	A	19.5	27.7	32.7	39.2	51.8	63.0	76.6
E5-04	PM Motor Pole Count	-	6	6	6	6	6	6	6
E5-05	PM Motor Resistance (ohms/phase)	Ω	0.460	0.325	0.260	0.209	0.140	0.106	0.076
E5-06	PM d-axis Inductance (mH/phase)	mH	17.76	12.83	11.68	10.09	8.12	6.43	4.96
E5-07	PM q-axis Inductance (mH/phase)	mH	22.72	17.19	15.16	16.25	9.84	7.71	6.56
E5-09	PM Back-EMF V <sub>peak</sub> (mV/(rad/s))	mVs/rad	740.4	716.6	809.1	786.2	888.8	857.7	941.6
E5-24	PM Motor Induced Voltage Constant 2 (Ke)	mV/(r/min)	0.0	0.0	0.0	0.0	0.0	0.0	0.0
E1-04	Maximum Output Frequency	Hz	57.5	57.5	57.5	57.5	57.5	57.5	57.5
E1-05	Maximum Output Voltage	V	380.0	380.0	380.0	380.0	380.0	380.0	380.0
E1-06	Base Frequency	Hz	57.5	57.5	57.5	57.5	57.5	57.5	57.5
E1-09	Minimum Output Frequency	Hz	2.9	2.9	2.9	2.9	2.9	2.9	2.9
C5-17	Motor Inertia	kgm <sup>2</sup>	0.054	0.063	0.113	0.137	0.252	0.304	0.410
L3-24 *1	Motor Accel Time for Inertia Cal	s	0.071	0.061	0.089	0.090	0.122	0.119	0.132
n5-02	Motor Acceleration Time	s	0.071	0.061	0.089	0.090	0.122	0.119	0.132
n8-49	d-Axis Cur for High Efficiency Cont	%	-16.7	-20.2	-15.2	-27.7	-9.8	-10.2	-11.5

\*1 Default settings vary depending on the setting of o2-04 (Drive Model Selection).

## 10.22 Parameters Changed by PM Motor Code Selection

**Table 10.35 SST4 Series Motor Code Setting for Specification of 400 V at 1150 min<sup>-1</sup> (r/min)**

No.	Name	Unit	Motor Code (setting value of E5-01)						
			2445	2446	2447	2448	2449	244A	244C
E5-01	PM Motor Code Selection	-	2445	2446	2447	2448	2449	244A	244C
	Voltage Class	V	400	400	400	400	400	400	400
	Capacity	kW	55	75	90	110	132	160	200
	Motor Rotation Speed	min <sup>-1</sup>	1150	1150	1150	1150	1150	1150	1150
E5-02	PM Motor Rated Power (kW)	kW	55.00	75.00	90.00	110.00	132.00	160.00	200.00
E5-03	PM Motor Rated Current (FLA)	A	93.1	128.1	153.1	186.5	221.9	269.8	336.5
E5-04	PM Motor Pole Count	-	6	6	6	6	6	6	6
E5-05	PM Motor Resistance (ohms/phase)	Ω	0.051	0.032	0.026	0.015	0.012	0.009	0.007
E5-06	PM d-axis Inductance (mH/phase)	mH	3.99	2.97	2.44	1.87	1.49	1.41	1.22
E5-07	PM q-axis Inductance (mH/phase)	mH	5.39	3.90	3.23	2.46	2.08	1.88	1.51
E5-09	PM Back-EMF V <sub>peak</sub> (mV/(rad/s))	mVs/rad	853.8	829.6	835.6	833.4	848.6	889.1	915.0
E5-24	PM Motor Induced Voltage Constant 2 (K <sub>e</sub> )	mV/(r/min)	0.0	0.0	0.0	0.0	0.0	0.0	0.0
E1-04	Maximum Output Frequency	Hz	57.5	57.5	57.5	57.5	57.5	57.5	57.5
E1-05	Maximum Output Voltage	V	380.0	380.0	380.0	380.0	380.0	380.0	380.0
E1-06	Base Frequency	Hz	57.5	57.5	57.5	57.5	57.5	57.5	57.5
E1-09	Minimum Output Frequency	Hz	2.9	2.9	2.9	2.9	2.9	2.9	2.9
C5-17	Motor Inertia	kgm <sup>2</sup>	0.55	0.82	0.96	1.60	1.95	2.82	3.70
L3-24 *1	Motor Accel Time for Inertia Cal	s	0.145	0.159	0.155	0.211	0.214	0.256	0.268
n5-02	Motor Acceleration Time	s	0.145	0.159	0.155	0.211	0.214	0.256	0.268
n8-49	d-Axis Cur for High Efficiency Cont	%	-15.9	-15.7	-15.7	-14.7	-16.5	-14.1	-10.3

\*1 Default settings vary depending on the setting of o2-04 [Drive Model Selection].



## Parameter Details

---

11.1	Safety Precautions .....	674
11.2	A: Initialization Parameters.....	675
11.3	b: Application .....	697
11.4	C: Tuning .....	749
11.5	d: References .....	775
11.6	E: Motor Parameters .....	798
11.7	F: Options .....	820
11.8	H: Terminal Functions .....	862
11.9	L: Protection Functions .....	939
11.10	n: Special Adjustment.....	987
11.11	o: Keypad-Related Settings.....	1010
11.12	T: Auto-Tuning.....	1032

## 11.1 Safety Precautions

### DANGER

**Do not ignore the safety messages in this manual. The operating company is responsible for injuries or equipment damage caused from ignoring the messages in this manual.**

Failure to obey the safety messages will cause death or serious injury.

## 11.2 A: Initialization Parameters

*A* parameters [Initialization Parameters] set the operating environment and operating conditions for the drive.

### ◆ A1: Initialization

*A1* parameters set the operating environment and operating conditions for the drive. For example, these parameters set the keypad language, the control method, and the parameter access level for the drive.

#### ■ A1-00: Language Selection

No. (Hex.)	Name	Description	Default (Range)
A1-00 (0100) RUN	Language Selection	<b>V/f</b> <b>CL-V/f</b> <b>OLV</b> <b>CLV</b> <b>AOLV</b> <b>OLV/PM</b> <b>AOLV/PM</b> <b>CLV/PM</b> <b>EZOLV</b> Sets the language for the LCD keypad.	0 (0 - 12)

**Note:**

When you initialize the drive with parameter *A1-03* [Initialize Parameters], the drive will not reset this parameter.

#### 0 : English

#### 1 : Japanese

#### 2 : German

#### 3 : French

#### 4 : Italian

#### 5 : Spanish

#### 6 : Portuguese

#### 7 : Chinese

#### 8 : Czech

#### 9 : Russian

#### 10 : Turkish

#### 11 : Polish

#### 12 : Greek

#### ■ A1-01: Access Level Selection

No. (Hex.)	Name	Description	Default (Range)
A1-01 (0101) RUN	Access Level Selection	<b>V/f</b> <b>CL-V/f</b> <b>OLV</b> <b>CLV</b> <b>AOLV</b> <b>OLV/PM</b> <b>AOLV/PM</b> <b>CLV/PM</b> <b>EZOLV</b> Sets user access to parameters. The access level controls which parameters the keypad will display, and which parameters the user can set.	2 (0 - 3)

#### 0 : Operation Only

Access to *A1-00*, *A1-01*, *A1-04* [Password], and the *U* Monitors.

#### 1 : User Parameters

Access to *A1-00*, *A1-01*, *A1-04*, and *A2-01* to *A2-32* [User Parameters 1 to 32].

#### 2 : Advanced Level

Access to all parameters, but not Expert Mode parameters.

#### 3 : Expert Level

Access to all parameters including Expert Mode parameters.

Table 11.1 shows which keypad screens are available for each *A1-01* settings.


**Table 11.1 Access Level and Available Keypad Screens**

Mode	Keypad Screen	A1-01 [Access Level Selection] Setting			
		0	1	2	3
Drive Mode	Monitors	Yes	Yes	Yes	Yes
Programming Mode	Parameters	Yes	Yes	Yes	Yes
	User Custom Parameters	No	Yes	Yes	Yes
	Parameter Backup/Restore	No	No	Yes	Yes
	Modified Parameters/Fault Log	No	No	Yes	Yes
	Auto-Tuning	No	No	Yes	Yes
	Initial Setup Screen	No	No	Yes	Yes
	Diagnostic Tools	No	No	Yes	Yes

**Note:**

- When you use A1-04 and A1-05 [Password Setting] to set a password, you cannot change the values set in A1-01 to A1-03, A1-06, A1-07, or A2-01 to A2-32.
- When H1-xx = 1B [MFDI Function Select = Program Lockout], you must activate the terminal to change parameter settings.
- When you use MEMOBUS/Modbus communications, you must send the Enter command from the controller to the drive and complete the serial communication write process before you can use the keypad to change parameter settings.

**■ A1-02: Control Method Selection**

No. (Hex.)	Name	Description	Default (Range)
A1-02 (0102)	Control Method Selection	 Sets the control method for the drive application and the motor.	0 (0 - 8)

**Note:**

- When you change the A1-02 setting, the parameter values specified by A1-02 are changed to their default values.
- To use the 2 motor switchover function, first turn OFF the terminal to which H1-xx = 16 [MFDI Function Select = Motor 2 Selection] is set, then change the A1-02 setting. An incorrect procedure will trigger oPE08 [Parameter Selection Error].

Selects the control method for the drive application and the motor.

**0 : V/f Control**

Use this control method in these applications and conditions:

- For general variable-speed control applications in which a high level of responsiveness or high-precision speed control is not necessary.
- To connect more than one motor to one drive
- When there is not sufficient data to set the motor parameters
- When it is not possible to do Auto-Tuning. The speed control range is 1:40.

**1 : V/f Control with Encoder**

Use this control method in these applications and conditions:

- For general applications in which a high level of responsiveness is not necessary, but high-precision speed control is necessary.
- When there is not sufficient data to set the motor parameters
- When it is not possible to do Auto-Tuning. The speed control range is 1:40.

**2 : Open Loop Vector**

Use this control method for general variable-speed control applications in which high-precision speed control is necessary. In this control method, a feedback signal from the motor is not necessary to have high torque response and high torque when operating at low speeds. The speed control range is 1:120.

**3 : Closed Loop Vector**

Use this control method for general variable-speed control applications in which these qualities are necessary:

- A high level of responsiveness
- High-precision speed control up to zero speed

- High-precision torque control. A speed feedback signal from the motor is necessary for this control method. The speed control range is 1:1500.

#### 4 : Advanced Open Loop Vector

This is a control method for induction motors. Use this control method for applications in which high-precision speed control is necessary.

This control method has high speed and torque response and high torque when operating at low speeds. The speed control range is 1:200.

#### 5 : PM Open Loop Vector

The drive controls an IPM motor or SPM motor in this control method. Use this control method for general variable-speed control applications in which a high level of responsiveness or high-precision speed control are not necessary. The speed control range is 1:20.

#### 6 : PM Advanced Open Loop Vector

The drive can control an IPM motor in this control method. Use this control method for general variable-speed control applications in which high-precision speed control and torque limit are necessary. The speed control range is 1:20. The speed control range is 1:100 when  $n8-57 = 1$  [*HFI Overlap Selection = Enabled*].

#### 7 : PM Closed Loop Vector

The drive controls a PM motor in this control method. Use this control method for constant torque applications in which high-precision control with a PM motor is necessary. Also use this control method for general variable-speed control applications in which high torque response and high-precision torque control are necessary. A speed feedback signal from the motor is necessary for this control method. The speed control range is 1:1500.

#### 8 : EZ Vector Control

The drive controls induction motors and PM motors in this control method. This control method uses an easier procedure to operate motors with more efficiency. Use this control method for derating torque applications. For example, fans and pumps.

### ■ A1-03: Initialize Parameters

No. (Hex.)	Name	Description	Default (Range)
A1-03 (0103)	Initialize Parameters	<input type="checkbox"/> V/f <input type="checkbox"/> CL-V/f <input type="checkbox"/> OLV <input type="checkbox"/> CLV <input type="checkbox"/> AOLV <input type="checkbox"/> OLV/IPM <input type="checkbox"/> AOLV/IPM <input type="checkbox"/> CLV/IPM <input type="checkbox"/> EZOLV Sets parameters to default values.	0 (0 - 3330)

#### Note:

- After you initialize the drive, the drive automatically sets  $A1-03 = 0$ .
- User Parameters can save the parameter values for your application and use these values as default values for drive initialization.
- To use the 2 motor switchover function, first turn OFF the terminal to which  $H1-xx = 16$  [*MFDI Function Select = Motor 2 Selection*] is set, then change the  $A1-02$  setting. An incorrect procedure will trigger  $oPE08$  [*Parameter Selection Error*].

#### 0 : No Initialization

##### 1110 : User Initialization

Sets parameters to the values set by the user as user settings. Set  $o2-03 = 1$  [*User Parameter Default Value = Set defaults*] to save the user settings.

You can save the parameter settings that were adjusted for the test run as user-set default values to the drive. Set  $A1-03 = 1110$  to reset to the saved parameter settings.

Follow this procedure to save User Parameter setting values, and to do a User Initialization.

1. Set parameters correctly for the application.
2. Set  $o2-03 = 1$  [*User Parameter Default Value = Set defaults*].  
This saves parameter settings for a User Initialization.  
The drive will then automatically set  $o2-03 = 0$ .
3. When you make changes to the parameter values after you save the settings as User Parameter Settings, the drive will set the parameters to the User Parameter Setting value when you initialize with  $A1-03 = 1110$ .  
When you initialize the drive, the drive sets the parameter values to the User Parameter setting values.

##### 2220 : 2-Wire Initialization

Sets MFDI terminal S1 to Forward Run and terminal S2 to Reverse Run, and resets all parameters to default settings.

##### 3330 : 3-Wire Initialization

## 11.2 A: Initialization Parameters

Sets MFDI terminal S1 to Run, terminal S2 to Stop, and terminal S5 to FWD/REV, and resets all parameters to default settings.

The drive will not initialize the parameters in [Table 11.2](#) when  $A1-03 = 2220, 3330$ .

**Table 11.2 Parameters that are not Initialized Using a 2-Wire Sequence or a 3-Wire Sequence**

No.	Name
A1-00	Language Selection
A1-02	Control Method Selection
A1-07	DriveWorksEZ Function Selection
E1-03	V/f Pattern Selection
E5-01	PM Motor Code Selection
E5-02	PM Motor Rated Power (kW)
E5-03	PM Motor Rated Current (FLA)
E5-04	PM Motor Pole Count
E5-05	PM Motor Resistance (ohms/phase)
E5-06	PM d-axis Inductance (mH/phase)
E5-07	PM q-axis Inductance (mH/phase)
E5-09	PM Back-EMF V <sub>peak</sub> (mV/(rad/s))
E5-11	Encoder Z-Pulse Offset
E5-24	PM Back-EMF L-L V <sub>rms</sub> (mV/rpm)
E5-25	Polarity Estimation Timeout
F6-08	Comm Parameter Reset @Initialize
F6-xx/F7-xx	Communication Option Parameters Set $F6-08 = 1$ [ <i>Comm Parameter Reset @Initialize = Reset Back to Factory Default</i> ] to initialize communication option card parameters.
L8-35	Installation Method Selection
o2-04	Drive Model (KVA) Selection
q1-xx - q8-xx	DriveWorksEZ Parameters
r1-xx	DWEZ Connection 1-20

**Note:**


- Set  $A1-06$  [*Application Preset*] to let the drive automatically set the best parameter settings for the selected application. The drive does not initialize  $A1-02$  when  $A1-03 = 2220, 3330$ .
- When  $A1-03 = 2220, 3330$ , the drive automatically set  $A1-05$  [*Password Setting*] = 0000. Make sure that you set the password again for applications where a password is necessary.

### ■ A1-04: Password

No. (Hex.)	Name	Description	Default (Range)
A1-04 (0104)	Password	<div style="display: flex; gap: 5px;"> <span>V/f</span> <span>CL-V/f</span> <span>QLV</span> <span>CLV</span> <span>AOLV</span> <span>OLV/PM</span> <span>AOLV/PM</span> <span>CLV/PM</span> <span>EZOLV</span> </div> Entry point for the password set in $A1-05$ [ <i>Password Setting</i> ]. The user can view the settings of parameters that are locked without entering the password. Enter the correct password in this parameter to change parameter settings.	0000 (0000 - 9999)

If the password entered in  $A1-04$  does not agree with the password setting in  $A1-05$ , you cannot change these parameters:

- $A1-01$  [*Access Level Selection*]
- $A1-02$  [*Control Method Selection*]
- $A1-03$  [*Initialize Parameters*]
- $A1-06$  [*Application Preset*]
- $A1-07$  [*DriveWorksEZ Function Selection*]
- $A2-01$  to  $A2-32$  [*User Parameter 1 to 32*]















To lock parameter settings after making changes without changing the password, enter the incorrect password in *A1-04* and push .


### Enter the Password to Unlock Parameters

Use this procedure to unlock parameter settings.










Set the password in *A1-05 [Password Setting]*, and show the Parameter Setting Mode screen on the keypad.

This procedure verifies the password, and makes sure that the parameter settings are unlocked.

1. Push  or  to select "A: Initialization Parameters", then push .
2. Push  or  to select [*A1-04*], then push .  
You can now change parameter settings.
3. Push  or  to move the digit and enter the password.
4. Push  to confirm the password.  
The drive unlocks the parameters and automatically shows the Parameters Screen.
5. Push  or  to show [*A1-02*], then push .
6. Push  or  to make sure that you can change the setting value.

Push  (Back) until the keypad shows the Parameter Setup Mode screen.



### ■ A1-05: Password Setting

No. (Hex.)	Name	Description	Default (Range)
A1-05 (0105)	Password Setting	         Set the password to lock parameters and prevent changes to parameter settings. Enter the correct password in <i>A1-04 [Password]</i> to unlock parameters and accept changes.	0000 (0000 - 9999)

This parameter can lock these parameter settings:










- *A1-01 [Access Level Selection]*
- *A1-02 [Control Method Selection]*
- *A1-03 [Initialize Parameters]*
- *A1-06 [Application Preset]*
- *A1-07 [DriveWorksEZ Function Selection]*
- *A2-01 to A2-32 [User Parameter 1 to 32]*

#### Note:

- Usually, the keypad will not show *A1-05*. To show and set *A1-05*, show *A1-04 [Password]* and then push  and  on the keypad at the same time.
- After you set *A1-05*, the keypad will not show it again until you enter the correct password in *A1-04*. Make sure that you remember the *A1-05* setting value. If you do not know the *A1-05* setting value, contact Yaskawa or your nearest sales representative.
- When *A1-03* = 2220, 3330 [*2-Wire Initialization, 3-Wire Initialization*], the drive is initialized to *A1-05* = 0000. Be sure to set the password again when a password is necessary for the application.
- Change the setting value in *A1-05* to change the password. The new setting value becomes the new password.
- When you use the password to unlock and change a parameter, enter a value other than the password in *A1-04* to lock the parameter again with the same password.
- If *A1-04* ≠ *A1-05*, MEMOBUS Communication cannot read or write *A1-05*.

### ■ A1-06: Application Preset

**WARNING!** Sudden Movement Hazard. If you set parameter *A1-06 [Application Preset]*, the drive can automatically change the I/O terminal function from the default setting. Make sure that the drive I/O signals and external sequence are correct before a test run. Failure to obey can cause death or serious injury.

No. (Hex.)	Name	Description	Default (Range)
A1-06 (0127)	Application Preset	         Sets the drive to operate in selected application conditions.	0 (0 - 7)

## 11.2 A: Initialization Parameters

The drive software contains the application presets shown below. Set *A1-06* to align with the application to let the drive automatically set the best parameter settings for the selected application. The drive saves parameters frequently used for the application in parameters *A2-01* to *A2-16* [*User Parameters 1 to 16*] for easy configuration and reference in [*User Custom Parameters*] in the main menu.

- Water supply pump
- Conveyor
- Exhaust fan
- HVAC fan
- Air compressor
- Crane (hoist)
- Crane (traveling)

**Note:**

- Before you set *A1-06*, make sure that you set *A1-03* = 2220, 3330 [*Initialize Parameters = 2-Wire Initialization, 3-Wire Initialization*] to initialize parameters.
  - After you set *A1-06* for a hoist application (*A1-06* = 6 or 7), make sure that you do Auto-Tuning.
  - It is not possible to change the *A1-06* value. To set an application preset, first set *A1-03* = 2220 to initialize parameters, then make a selection to *A1-06*. If initializing all parameters will cause a problem, do not change the settings.
- If you set *A2-33* = 1 [*User Parameter Auto Selection = Enabled: Auto Save Recent Parm*s] to set parameters to *A2-17* to *A2-32* [*User Parameters 17 to 32*] automatically, the drive will reset these parameters when you change the *A1-06* setting.

### 0 : General-purpose

The drive saves the parameters in [Table 11.3](#) as user parameters.

**Table 11.3 Parameters Saved as User Parameters with the General-purpose Preset**

User Parameter No.	Parameter No. Saved	Name
A2-01	A1-02	Control Method Selection
A2-02	b1-01	Frequency Reference Selection 1
A2-03	b1-02	Run Command Selection 1
A2-04	b1-03	Stopping Method Selection
A2-05	C1-01	Acceleration Time 1
A2-06	C1-02	Deceleration Time 1
A2-07	C6-01	Normal / Heavy Duty Selection
A2-08	C6-02	Carrier Frequency Selection
A2-09	d1-01	Reference 1
A2-10	d1-02	Reference 2
A2-11	d1-03	Reference 3
A2-12	d1-04	Reference 4
A2-13	d1-17	Jog Reference
A2-14	E1-01	Input AC Supply Voltage
A2-15	E1-03	V/f Pattern Selection
A2-16	E1-04	Maximum Output Frequency
A2-17	E1-05	Maximum Output Voltage
A2-18	E1-06	Base Frequency
A2-19	E1-09	Minimum Output Frequency
A2-20	E1-13	Base Voltage
A2-21	E2-01	Motor Rated Current (FLA)
A2-22	E2-04	Motor Pole Count
A2-23	E2-11	Motor Rated Power (kW)
A2-24	H4-02	Terminal FM Analog Output Gain
A2-25	L1-01	Motor Overload (oL1) Protection
A2-26	L3-04	Stall Prevention during Decel



## 1 : Water Supply Pump 2

The drive automatically sets the parameters in [Table 11.4](#) for a water supply pump application.

**Table 11.4 Best Parameter Settings for Water Supply Pump Applications**

No.	Name	Optimal Value
A1-02	Control Method Selection	0: V/f Control
b1-04	Reverse Operation Selection	1: Reverse Disabled
C1-01	Acceleration Time 1	1.0 s
C1-02	Deceleration Time 1	1.0 s
C6-01	Normal / Heavy Duty Selection	1: Normal Duty Rating
E1-03	V/f Pattern Selection	F: Custom
E1-07	Mid Point A Frequency	30.0 Hz
E1-08	Mid Point A Voltage	50.0 V
L2-01	Power Loss Ride Through Select	1: Enabled for L2-02 Time
L3-04	Stall Prevention during Decel	1: General Purpose

Parameters in [Table 11.5](#) as user parameters.

**Table 11.5 Parameters Saved as User Parameters with the Water Supply Pump Preset**

User Parameter No.	Parameter No. Saved	Name
A2-01	b1-01	Frequency Reference Selection 1
A2-02	b1-02	Run Command Selection 1
A2-03	b1-04	Reverse Operation Selection
A2-04	C1-01	Acceleration Time 1
A2-05	C1-02	Deceleration Time 1
A2-06	E1-03	V/f Pattern Selection
A2-07	E1-07	Mid Point A Frequency
A2-08	E1-08	Mid Point A Voltage
A2-09	E2-01	Motor Rated Current (FLA)
A2-10	H1-05	Terminal S5 Function Selection
A2-11	H1-06	Terminal S6 Function Selection
A2-12	H1-07	Terminal S7 Function Selection
A2-13	L5-01	Number of Auto-Restart Attempts

## 2 : Conveyor

The drive automatically sets the parameters in [Table 11.6](#) for a conveyor application.

**Table 11.6 Best Parameter Settings for Conveyor Applications**

No.	Name	Optimal Value
A1-02	Control Method Selection	0: V/f Control
C1-01	Acceleration Time 1	3.0 s
C1-02	Deceleration Time 1	3.0 s
C6-01	Normal / Heavy Duty Selection	0: Heavy Duty Rating
L3-04	Stall Prevention during Decel	1: General Purpose

Parameters in [Table 11.7](#) as user parameters.

**Table 11.7 Parameters Saved as User Parameters with the Conveyor Preset**

User Parameter No.	Parameter No. Saved	Name
A2-01	A1-02	Control Method Selection
A2-02	b1-01	Frequency Reference Selection 1

## 11.2 A: Initialization Parameters

User Parameter No.	Parameter No. Saved	Name
A2-03	b1-02	Run Command Selection 1
A2-04	C1-01	Acceleration Time 1
A2-05	C1-02	Deceleration Time 1
A2-06	E2-01	Motor Rated Current (FLA)
A2-07	L3-04	Stall Prevention during Decel

### 3 : Exhaust Fan

The drive automatically sets the parameters in [Table 11.8](#) for an exhaust fan application.

**Table 11.8 Best Parameter Settings for Exhaust Fan Applications**

No.	Name	Optimal Value
A1-02	Control Method Selection	0: V/f Control
b1-04	Reverse Operation Selection	1: Reverse Disabled
C6-01	Normal / Heavy Duty Selection	1: Normal Duty Rating
E1-03	V/f Pattern Selection	F: Custom
E1-07	Mid Point A Frequency	30.0 Hz
E1-08	Mid Point A Voltage	50.0 V
L2-01	Power Loss Ride Through Select	1: Enabled for L2-02 Time
L3-04	Stall Prevention during Decel	1: General Purpose

Parameters in [Table 11.9](#) as user parameters.

**Table 11.9 Parameters Saved as User Parameters with the Exhaust Fan Preset**

User Parameter No.	Parameter No. Saved	Name
A2-01	b1-01	Frequency Reference Selection 1
A2-02	b1-02	Run Command Selection 1
A2-03	b1-04	Reverse Operation Selection
A2-04	b3-01	Speed Search at Start Selection
A2-05	C1-01	Acceleration Time 1
A2-06	C1-02	Deceleration Time 1
A2-07	E1-03	V/f Pattern Selection
A2-08	E1-07	Mid Point A Frequency
A2-09	E1-08	Mid Point A Voltage
A2-10	E2-01	Motor Rated Current (FLA)
A2-11	H1-05	Terminal S5 Function Selection
A2-12	H1-06	Terminal S6 Function Selection
A2-13	H1-07	Terminal S7 Function Selection
A2-14	L5-01	Number of Auto-Restart Attempts

### 4 : HVAC Fan

The drive automatically sets the parameters in [Table 11.10](#) for an HVAC fan application.

**Table 11.10 Best Parameter Settings for HVAC Applications**

No.	Name	Optimal Value
A1-02	Control Method Selection	0: V/f Control
b1-04	Reverse Operation Selection	1: Reverse Disabled
b1-17	Run Command at Power Up	1: Accept Existing RUN Command
C6-01	Normal / Heavy Duty Selection	1: Normal Duty Rating

No.	Name	Optimal Value
C6-02	Carrier Frequency Selection	3: 8.0 kHz
H2-03	Term M5-M6 Function Selection	39: Watt Hour Pulse Output
L2-01	Power Loss Ride Through Select	2: Enabled while CPU Power Active
L8-03	Overheat Pre-Alarm Selection	4: Operate at Reduced Speed (L8-19)
L8-38	Carrier Frequency Reduction	2: Enabled for All Speeds

parameters in [Table 11.11](#) as user parameters.

**Table 11.11 Parameters Saved as User Parameters with the HVAC Preset**

User Parameter No.	Parameter No. Saved	Name
A2-01	b1-01	Frequency Reference Selection 1
A2-02	b1-02	Run Command Selection 1
A2-03	b1-03	Stopping Method Selection
A2-04	b1-04	Reverse Operation Selection
A2-05	C1-01	Acceleration Time 1
A2-06	C1-02	Deceleration Time 1
A2-07	C6-02	Carrier Frequency Selection
A2-08	d2-01	Frequency Reference Upper Limit
A2-09	d2-02	Frequency Reference Lower Limit
A2-10	E1-03	V/f Pattern Selection
A2-11	E1-04	Maximum Output Frequency
A2-12	E2-01	Motor Rated Current (FLA)
A2-13	H3-11	Terminal A2 Gain Setting
A2-14	H3-12	Terminal A2 Bias Setting
A2-15	L2-01	Power Loss Ride Through Select
A2-16	o4-12	kWh Monitor Initialization

## 5 : Air Compressor

The drive automatically sets the parameters in [Table 11.12](#) for an air compressor application.

**Table 11.12 Best Parameter Settings for Air Compressor Applications**

No.	Name	Optimal Value
A1-02	Control Method Selection	0: V/f Control
b1-04	Reverse Operation Selection	1: Reverse Disabled
C1-01	Acceleration Time 1	5.0 s
C1-02	Deceleration Time 1	5.0 s
C6-01	Normal / Heavy Duty Selection	0: Heavy Duty Rating
E1-03	V/f Pattern Selection	F: Custom
L2-01	Power Loss Ride Through Select	1: Enabled for L2-02 Time
L3-04	Stall Prevention during Decel	1: General Purpose

Parameters in [Table 11.13](#) as user parameters.

**Table 11.13 Parameters Saved as User Parameters with the Air Compressor Preset**

User Parameter No.	Parameter No. Saved	Name
A2-01	b1-01	Frequency Reference Selection 1
A2-02	b1-02	Run Command Selection 1
A2-03	b1-04	Reverse Operation Selection
A2-04	C1-01	Acceleration Time 1

## 11.2 A: Initialization Parameters

User Parameter No.	Parameter No. Saved	Name
A2-05	C1-02	Deceleration Time 1
A2-06	E1-03	V/f Pattern Selection
A2-07	E1-07	Mid Point A Frequency
A2-08	E1-08	Mid Point A Voltage
A2-09	E2-01	Motor Rated Current (FLA)

### 6 : Crane (Hoist)

The drive automatically sets the parameters in [Table 11.14](#) for a hoist application.

**Note:**

Make sure that you do Auto-Tuning after you set *A1-06* for a hoist application. Refer to *Notes for Elevator Applications on page 686* for hoist (elevator) instructions.

**Table 11.14 Best Parameter Settings for Hoist Applications**

No.	Name	Optimal Value
A1-02	Control Method Selection	2: Open Loop Vector
b1-01	Frequency Reference Selection 1	0: Keypad
b6-01	Dwell Reference at Start	3.0 Hz
b6-02	Dwell Time at Start	0.3 s
C1-01	Acceleration Time 1	3.0 s
C1-02	Deceleration Time 1	3.0 s
C6-01	Normal / Heavy Duty Selection	0: Heavy Duty Rating
C6-02	Carrier Frequency Selection	2: 5.0 kHz (4.0 kHz for AOLV/PM)
d1-01	Reference 1	6.00 Hz
d1-02	Reference 2	30.00 Hz
d1-03	Reference 3	50.00 Hz
E1-03	V/f Pattern Selection	F: Custom
H2-01	Term M1-M2 Function Selection	5: Frequency Detection 2
H2-02	Term M3-M4 Function Selection	37: During Frequency Output
H3-06	Terminal A3 Function Selection	F: Not Used
L2-03	Minimum Baseblock Time	0.3 s
L3-04	Stall Prevention during Decel	0: Disabled
L4-01	Speed Agree Detection Level	2.0 Hz
L4-02	Speed Agree Detection Width	0.0 Hz
L6-01	Torque Detection Selection 1	8: UL @ RUN - Fault
L6-02	Torque Detection Level 1	2%
L6-03	Torque Detection Time 1	0.5 s
L8-05	Input Phase Loss Protection Sel	1: Enabled
L8-07	Output Phase Loss Protection Sel	1: Enabled
L8-38	Carrier Frequency Reduction	1: Enabled below 6 Hz
L8-41	High Current Alarm Selection	1: Enabled

parameters in [Table 11.15](#) as user parameters.

**Table 11.15 Parameters Saved as User Parameters with the Hoist Preset**

User Parameter No.	Parameter No. Saved	Name
A2-01	A1-02	Control Method Selection
A2-02	b1-01	Frequency Reference Selection 1

User Parameter No.	Parameter No. Saved	Name
A2-03	b6-01	Dwell Reference at Start
A2-04	b6-02	Dwell Time at Start
A2-05	C1-01	Acceleration Time 1
A2-06	C1-02	Deceleration Time 1
A2-07	C6-02	Carrier Frequency Selection
A2-08	d1-01	Reference 1
A2-09	d1-02	Reference 2
A2-10	d1-03	Reference 3
A2-11	E1-08	Mid Point A Voltage
A2-12	H2-01	Term M1-M2 Function Selection
A2-13	L1-01	Motor Overload (oL1) Protection
A2-14	L4-01	Speed Agree Detection Level
A2-15	L6-02	Torque Detection Level 1
A2-16	L6-03	Torque Detection Time 1

## 7 : Crane (Traveling)

The drive automatically sets the parameters in [Table 11.16](#) for a traveling application.

**Table 11.16 Optimal Settings for Traveling Applications**

No.	Name	Optimal Value
A1-02	Control method selection	0: V/f Control
b1-01	Frequency Reference Selection 1	0: Keypad
C1-01	Acceleration Time 1	3.0 s
C1-02	Deceleration Time 1	3.0 s
C6-01	Normal / Heavy Duty Selection	0: Heavy Duty Rating
C6-02	Carrier Frequency Selection	2: 5.0 kHz (4.0 kHz for AOLV/PM)
d1-01	Reference 1	6.00 Hz
d1-02	Reference 2	30.00 Hz
d1-03	Reference 3	50.00 Hz
H1-05	Terminal S5 Function Selection	3: Multi-Step Speed Reference 1
H1-06	Terminal S6 Function Selection	4: Multi-Step Speed Reference 2
H2-01	Term M1-M2 Function Selection	37: During Frequency Output
H2-02	Term M3-M4 Function Selection	37: During Frequency Output
H3-06	Terminal A3 Function Selection	1F: Not Used
L3-04	Stall Prevention during Decel	0: Disabled
L8-05	Input Phase Loss Protection Sel	1: Enabled
L8-07	Output Phase Loss Protection Sel	1: Fault when one phase is lost
L8-38	Carrier Frequency Reduction	1: Enabled below 6 Hz
L8-41	High Current Alarm Selection	1: Enabled

Parameters in [Table 11.17](#) as user parameters.

**Table 11.17 Parameters Saved as User Parameters with the Traveling Preset**

User Parameter No.	Parameter No. Saved	Name
A2-01	b1-01	Frequency Reference Selection 1
A2-02	C1-01	Acceleration Time 1
A2-03	C1-02	Deceleration Time 1

User Parameter No.	Parameter No. Saved	Name
A2-04	C6-02	Carrier Frequency Selection
A2-05	d1-01	Reference 1
A2-06	d1-02	Reference 2
A2-07	d1-03	Reference 3
A2-08	E2-01	Motor Rated Current (FLA)
A2-09	H1-05	Terminal S5 Function Selection
A2-10	H1-06	Terminal S6 Function Selection
A2-11	H2-01	Term M1-M2 Function Selection
A2-12	L1-01	Motor Overload (oL1) Protection

■ Notes for Elevator Applications

When using the drive for elevator applications, read the safety descriptions and precautions, and safely and correctly use the device.

Conditions to Open and Close the Brake

Set  $L4-07 = 0$  [Speed Agree Detection Selection = No Detection during Baseblock] to open and close the holding brake.

When  $L4-07 = 1$  [Detection Always Enabled], the output frequency increases when you input the Run command although the external baseblock command is input. Because of this, speed detection operates and will open the brake signal.

- Set Related Parameters

Table 11.18 shows examples of parameter settings to use the MFDO terminal (M1-M2) as the holding brake open and close signal.

Table 11.18 Holding Brake Open and Close Signal Setting Example

Brake Open and Close Signal		Brake Open and Close Level Adjust		Applicable Control Methods (A1-02 Setting Value)			
Signal Name	Parameter Settings	Signal Name	Parameter Settings	V/f (0)	OLV (2)	CLV (3)	CLV/PM (7) *1
Frequency (FOUT) Detection 2	$L4-07 = 0$	Speed Agree Detection Level	$L4-01 = 1.0 \text{ Hz to } 3.0 \text{ Hz}^*2$	x	x	-	-
	$H2-01 = 5$	Speed Agree Detection Width	$L4-02 = 0.0 \text{ Hz to } 0.5 \text{ Hz}^*3$				
During Frequency Output	$H2-01 = 37$	DC Injection/Zero Speed Threshold	$b2-01 = 0.1 \text{ Hz to } 0.5 \text{ Hz}$	-	-	x	x

- \*1 When  $A1-02 = 7$  [PM Closed Loop Vector], make sure that the motor can rotate before you do Auto-Tuning or switch the encoder. Refer to Closed Loop Vector Control for induction motors for information about the signal to use and the adjustment method.
- \*2 When  $A1-02 = 2$  [Open Loop Vector], it is the usual setting range. When  $A1-02 = 0$  [V/f Control], set  $L4-01$  to the rated slip frequency of the motor + approximately 0.5 Hz. If you set the value too low, motor torque will not be sufficient and it will cause motor rollback. Set the parameter to agree with these conditions: If you set the value too high, there will be overshoot during start up:
  - $L4-01 > E1-09$  [Minimum Output Frequency]
  - $L4-01 > L4-02$  [Speed Agree Detection Width]
- \*3 Use  $L4-02$  to adjust the detection width of Frequency Detection 2. If rollback occurs when the motor is stopped, change the frequency to approximately 0.1 Hz.

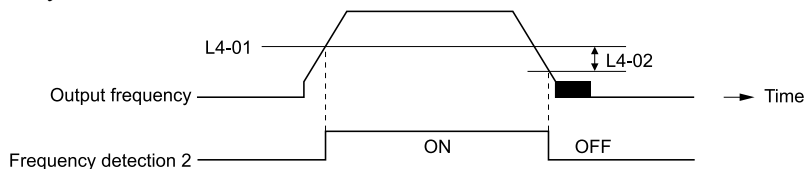


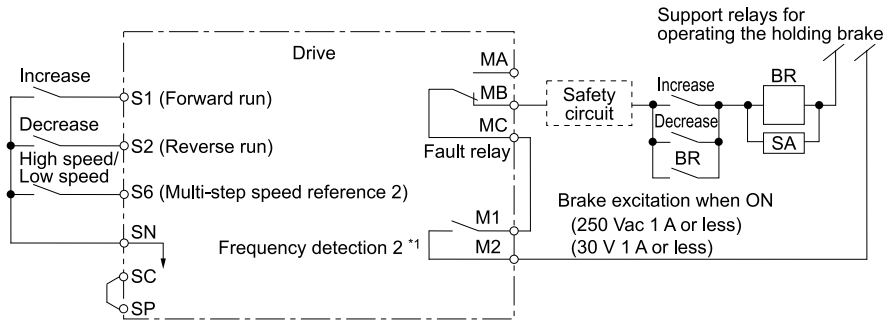
Figure 11.1 Frequency Detection 2

Sequence Circuit Configuration

Use these conditions to set the circuit for the open/close sequence of the holding brake:

- Set the sequence-side operation conditions to activate terminal M1-M2 and open the holding brake.
- Set the sequence to close the holding brake in an emergency if the drive detects a fault.

- Set the sequence to open the holding brake when you enter an increase or decrease command.

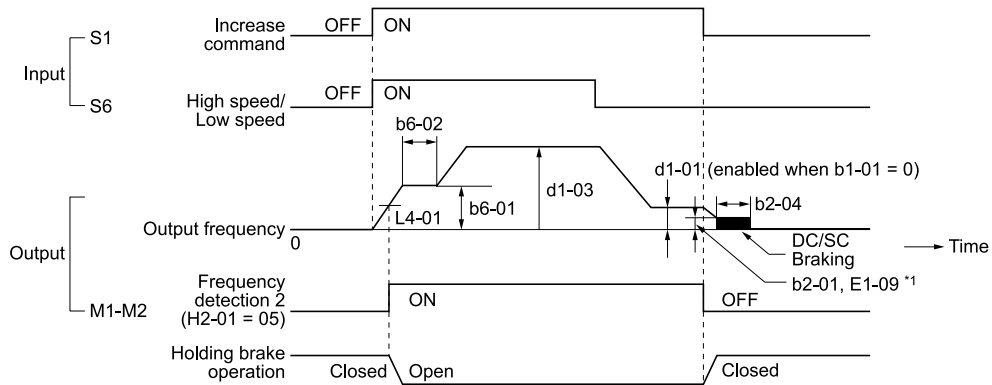


**Figure 11.2 Sequence Circuit Configuration Diagram**

- \*1  $L4-07 = 0$  [Speed Agree Detection Selection = No Detection during Baseblock] or During Frequency Output

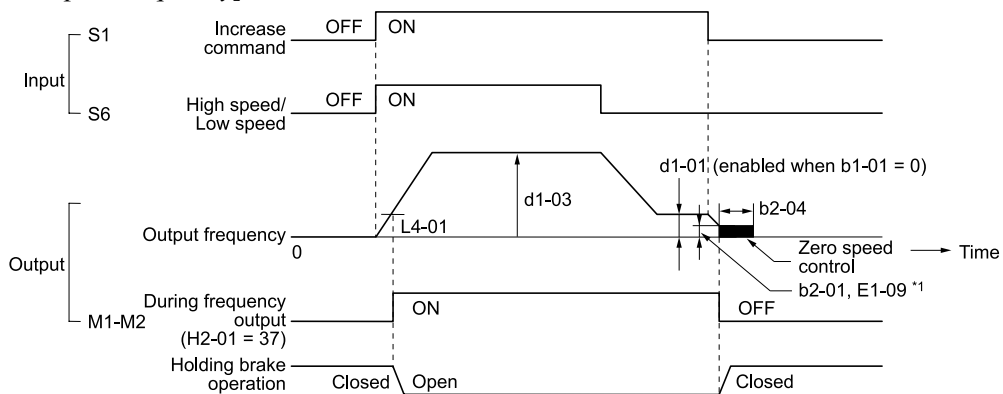
**Time Chart**

Figure 11.3 shows the open/close sequence of the holding brake.



**Figure 11.3 Holding Brake Open and Close Sequence Time Chart (V/f, CL-V/f, OLV)**

- \*1 Start braking from the higher set frequency between  $b2-01$  [DC Injection/Zero SpeedThreshold] or  $E1-09$  [Minimum Output Frequency].



**Figure 11.4 Holding Brake Open and Close Sequence Time Chart (CLV, CLV/PM)**

- \*1 Start braking from the higher set frequency between  $b2-01$  [DC Injection/Zero SpeedThreshold] or  $E1-09$  [Minimum Output Frequency].

## Notes on when Using Other Functions

Function	Notes
Decel stall prevention function	<p>When you connect a braking resistor to discharge the regenerative power to the drive, set <math>L3-04 = 0</math> [<i>Stall Prevention during Decel = Disabled</i>].</p> <p><b>Note:</b></p> <p>If <math>L3-04 = 1</math> [<i>General Purpose</i>], it is possible that the drive will not stop in the set deceleration time. Do not change the default settings of these related parameters:</p> <ul style="list-style-type: none"> <li>• <math>L3-01 = 1</math> [<i>Stall Prevention during Accel = Enabled</i>]</li> <li>• <math>L3-05 = 1</math> [<i>Stall Prevention during RUN = Deceleration Time 1 (C1-02)</i>]</li> </ul>
Auto-Tuning for Induction Motors	<ul style="list-style-type: none"> <li>• When <math>A1-02 = 2</math> or <math>3</math> [<i>Control Method Selection = Open Loop Vector or Closed Loop Vector</i>], Auto-Tune the motor before you operate the drive.</li> <li>• Disconnect the drive from the motor to do Rotational Auto-Tuning.</li> <li>• Auto-Tuning runs automatically for approximately 1 minute. Do not do Auto-Tuning with the motor engaged in the elevator system.</li> </ul> <p><b>Note:</b></p> <ul style="list-style-type: none"> <li>• If you cannot disconnect the motor from the machine, do Stationary Auto-Tuning. When you do Stationary Auto-Tuning, the drive energizes the motor and the motor stays stopped. During this time, the drive automatically measures the necessary motor data. If the motor test report or the motor nameplate is not available, use Stationary Auto-Tuning.</li> <li>• Do Stationary Auto-Tuning for Line-to-Line Resistance for better torque characteristics at low speeds in the V/f Control mode.</li> <li>• To Auto-Tune a specialized motor, for example a wound motor, prepare a motor test report before Auto-Tuning and make sure that the motor parameter <math>E2-xx</math> is not too different than the value in the test report.</li> </ul>
Auto-Tuning for PM Motors	<p>You must set the motor data in the drive to run a PM motor.</p> <ul style="list-style-type: none"> <li>• When you use a PM motor recommended by Yaskawa Input the motor code in <math>E5-01</math>. The drive will automatically set <math>E5</math> and other related motor parameters to the best values.</li> <li>• When you use a non-Yaskawa PM motor Do Auto-Tuning. <ul style="list-style-type: none"> <li>– When the motor nameplate or motor test report is available, enter the PM motor parameters directly with PM Motor Parameter Settings.</li> <li>– If the motor nameplate or motor test report is not available, and the motor cannot rotate, do PM Stationary Auto-Tuning.</li> <li>– If the motor nameplate or motor test report is not available, and the motor can rotate, do PM Rotational Auto-Tuning.</li> <li>– When you replace an encoder, make sure that the motor can rotate and do Z Pulse Offset Tuning or PM Rotational Auto-Tuning.</li> </ul> </li> </ul> <p><b>Note:</b></p> <ul style="list-style-type: none"> <li>• Use in Closed Loop Vector Control for PM mode.</li> <li>• When you do Auto-Tuning or replace the encoder, make sure that the motor can rotate.</li> <li>• Set the Encoder Z-Pulse Offset.</li> <li>• Refer to Closed Loop Vector Control for induction motors for information about the signal to use and the adjustment method.</li> </ul>
Braking Resistor Overheat Protection	<p>When you use a braking resistor other than the optional Yaskawa braking resistor unit (LKEB-series), this function uses the thermal overload relay to detect braking resistor overheat Load a sequence program that cuts the drive input power supply when the braking resistor overheats.</p> <p><b>Note:</b></p> <p>Refer to <a href="#">73</a> when you load the sequence circuit.</p>
Continuous operation function	<p>Do not use the momentary power loss continuous operation function and the Auto Restart function. If you use these functions, there is a risk that the motor will coast to a stop if the brake is open when there is a momentary power loss and the drive is operating or if there is a fault.</p> <p>Set the these parameters:</p> <ul style="list-style-type: none"> <li>• <math>L2-01 = 0</math> [<i>Power Loss Ride Through Select = Disabled</i>]</li> <li>• <math>L5-01 = 0</math> [<i>Number of Auto-Restart Attempts = 0</i>]</li> </ul>
Torque limit function	<p>The motor rated torque sets the value for <math>L7-01</math> to <math>L7-04</math> [<i>Torque Limit</i>]. If there will not be sufficient torque during start up, replace the drive with a larger capacity drive and set the torque limit between 200% and 300%. The <math>L7-01</math> to <math>L7-04</math> default setting is 200%.</p>



Function	Notes
I/O phase loss protection, overtorque detection function	<p>To stop a fall because of phase loss, set these parameters.</p> <ul style="list-style-type: none"> <li>• L8-05 = 1 [Input Phase Loss Protection Sel = Enabled]</li> <li>• L8-07 = 1 [Output Phase Loss Protection Sel = Fault when one phase is lost]</li> <li>• L6-01, L6-04 = 1 to 8 [Torque Detection Selection 1/2 = oL @ Speed Agree - Alarm only to UL @ RUN - Fault]</li> <li>• L6-02, L6-05 [Torque Detection Level 1/2]</li> <li>• L6-03, L6-06 [Torque Detection Time 1/2]</li> </ul> <p><b>Note:</b> Use precautions, for example fall detection, on the machine side.</p>
External baseblock command	<ul style="list-style-type: none"> <li>• If you enter the external baseblock signal set in H1-01 to H1-08 = 8 or 9 [Terminal S1 to S8 Function Selection = Baseblock Command] during run, the motor immediately coasts to stop. When you enter a baseblock command while the motor is operating, make sure that it is necessary.</li> <li>• When you use an external baseblock command for the fast stop and operation start up interlocks, load the sequence to lock the holding brake when you enter the external baseblock command.</li> <li>• If you enter the external baseblock command and then immediately remove it, the drive will not output the voltage in the time set in L2-03 [Minimum Baseblock Time]. Do not use an external baseblock command for applications that have frequent Run/Stop commands.</li> </ul>
Accel/Decel Time	<p>If you set the acceleration and deceleration times for the drive side too short and you do not add the mechanical operation delay time of the holding brake, the holding brake could operate late, or there could be overcurrent at start up, the brake could grind, or the motor could roll back when it stops. In these conditions, use Dwell Reference at Start/Time and DC Injection Braking at Stop to adjust the holding brake timing.</p>
Electromagnetic contactor on the drive output side	<p>Usually you must not install the electromagnetic contactor between the drive and motor. When you must install an electromagnetic contactor to use one drive to switchover more than one motor, follow these precautions:</p> <ul style="list-style-type: none"> <li>• Load a sequence that opens and closes the electromagnetic contactor when these two conditions are satisfied at the same time, unless there is an emergency: <ul style="list-style-type: none"> <li>– The holding brake is fully closed</li> <li>– The drive terminals for H2-xx = 8 or 1B [MFDO Function Select = During Baseblock] are activated</li> </ul> </li> <li>• If you open and close the electromagnetic contactor during motor control or during DC Injection Braking (or zero speed control), the surge voltage and the motor direct input current can cause the drive to detect faults.</li> <li>• When you install the electromagnetic contactor between the drive and the motor, set L8-07 = 1 or 2 [Output Phase Loss Protection Sel = Fault when one phase is lost or Fault when two phases are lost].</li> </ul>

### Adjustments Relating to Control

When there is oscillation, rollback, or other control problems, adjust the parameters as specified by the control method.

*V/f Control and Closed Loop V/f Control on page 689* shows only the frequently adjusted parameters.

**Note:**

Torque and speed response for high-resistance and high-slip motors are slow. Adjust the torque and speed response to increase them. Low impedance (low-slip) motors will hunt and oscillate. Adjust the torque and speed response to increase them.

### V/f Control and Closed Loop V/f Control

While in V/f Control, do not use C3-01 [Slip Compensation Gain].

While in Closed Loop V/f Control, continue to use default settings for C5-01 to C5-05 [ASR Parameters]. Significantly altering the default settings will likely cause oscillation.

**Table 11.19 Adjustment of Drive Control (V/f Control and Closed Loop V/f Control Methods)**

Adjustment description	Parameter Number	Solution	Default Setting	Suggested Setting
<ul style="list-style-type: none"> <li>Prevent hunting and oscillation at middle-range speeds (10 Hz to 40 Hz)</li> </ul>	n1-02 [Hunting Prevention Gain Setting]	<ul style="list-style-type: none"> <li>If the torque is not sufficient with heavy loads, decrease the setting.</li> <li>If there is hunting or oscillation with light loads, increase the setting.</li> </ul>	1.00	0.50 - 2.00
<ul style="list-style-type: none"> <li>Increasing motor excitation sound</li> <li>Hunting and oscillation suppression at low speeds and middle-range speeds</li> </ul>	C6-02 [Carrier Frequency Selection]	<ul style="list-style-type: none"> <li>If there is a loud motor excitation sound, increase the setting value.</li> <li>If there is hunting or oscillation at low speeds or middle-range speeds, decrease the setting value.</li> </ul>	*1	1 - F
<ul style="list-style-type: none"> <li>Increase torque at low speeds (10 Hz or lower)</li> <li>Prevent hunting and oscillation</li> </ul>	C4-01 [Torque Compensation Gain]	<ul style="list-style-type: none"> <li>If the torque is not sufficient at low speeds, increase the setting value.</li> <li>If there is hunting or oscillation with light loads, decrease the setting value.</li> </ul>	1.00	0.50 - 1.50
<ul style="list-style-type: none"> <li>Increase torque at low speeds</li> <li>Prevent shock during start up</li> </ul>	E1-08 [Mid Point A Voltage]	<ul style="list-style-type: none"> <li>If the torque is not sufficient at low speeds, increase the setting value.</li> <li>If there is a large shock during start up, decrease the setting value.</li> </ul>	15.0 V *2 *3	13.0 V to 16.0 V *3
	E1-10 [Minimum Output Voltage]		9.0 V *2 *3	7.0 V to 10.0 V *3

\*1 The default setting changes when the settings for C6-01 [Normal / Heavy Duty Selection] and o2-04 [Drive Model (KVA) Selection] change.  
 \*2 The default setting changes when the settings for A1-02 [Control Method Selection] and E1-03 [V/f Pattern Selection] change.  
 \*3 This is the setting for 200 V class drives. Multiply the voltage by 2 for 400 V class drives.

**Open Loop Vector Control Method**

Do not adjust parameter C4-01 [Torque Compensation Gain]. Keep this parameter at its default setting.

If you cannot get speed accuracy during regeneration, set C3-04 = 1 [Slip Compensation at Regen = Enabled Above 6Hz]. If you cannot get speed accuracy at high speeds, set C3-05 = 1 [Output Voltage Limit Selection = Enabled].

**Table 11.20 Adjustment of Drive Control (Open Loop Vector Control Method)**

Adjustment description	Parameter Number	Solution	Default Setting	Suggested Setting
<ul style="list-style-type: none"> <li>Torque, increase speed response</li> <li>Prevent hunting and oscillation at middle-range speeds (10 Hz to 40 Hz)</li> </ul>	n2-01 [Automatic Freq Regulator Gain]	<ul style="list-style-type: none"> <li>If torque and speed response are slow, decrease the setting value.</li> <li>If there is hunting or oscillation, increase the setting value.</li> </ul>	1.00	0.50 - 2.00
<ul style="list-style-type: none"> <li>Torque, increase speed response</li> <li>Prevent hunting and oscillation</li> </ul>	C4-02 [Torque Compensation Delay Time] *1	<ul style="list-style-type: none"> <li>If torque and speed response are slow, decrease the setting value.</li> <li>If there is hunting or oscillation, increase the setting value.</li> </ul>	20 ms	20 - 100 ms

Adjustment description	Parameter Number	Solution	Default Setting	Suggested Setting
<ul style="list-style-type: none"> <li>Increase speed response</li> <li>Increase speed stability</li> </ul>	C3-02 [Slip Compensation Delay Time]	<ul style="list-style-type: none"> <li>When speed response is slow, decrease the setting value.</li> <li>If speed is not stable, increase the setting value.</li> </ul>	200 ms	100 - 500 ms
<ul style="list-style-type: none"> <li>Improve speed accuracy</li> </ul>	C3-01 [Slip Compensation Gain]	<ul style="list-style-type: none"> <li>If speed is too slow, increase the setting value.</li> <li>If speed is too fast, decrease the setting value.</li> </ul>	1.0	0.5 - 1.5
<ul style="list-style-type: none"> <li>Increase motor excitation sound</li> <li>Prevent hunting and oscillation at low-range speeds (10 Hz to or lower)</li> </ul>	C6-02 [Carrier Frequency Selection]	<ul style="list-style-type: none"> <li>If there is a loud motor excitation sound, increase the setting value.</li> <li>If there is hunting or oscillation at low speeds, decrease the setting value.</li> </ul>	*2	1 - F
<ul style="list-style-type: none"> <li>Increase torque and speed response at low speeds</li> <li>Prevent shock during start up</li> </ul>	E1-08 [Mid Point A Voltage]	<ul style="list-style-type: none"> <li>If the torque and speed response are slow, increase the setting value.</li> </ul>	11.0 V *3	12.0 V to 13.0 V *3
	E1-10 [Minimum Output Voltage]	<ul style="list-style-type: none"> <li>If there is a large shock during start up, decrease the setting value.</li> </ul>	2.0 V *3	2.0 V to 3.0 V *3

\*1 If the value for C4-02 [Torque Compensation Delay Time] is high, the current can increase during start up. Adjust and check the current during start up.

\*2 The default setting changes when the settings for C6-01 [Normal / Heavy Duty Selection] and o2-04 [Drive Model Selection] change.

\*3 This is the setting for 200 V class drives. Multiply the voltage by 2 for 400 V class drives.

### Closed Loop Vector Control Method

Table 11.21 Adjustment of Drive Control (Closed Loop Vector Control Method)

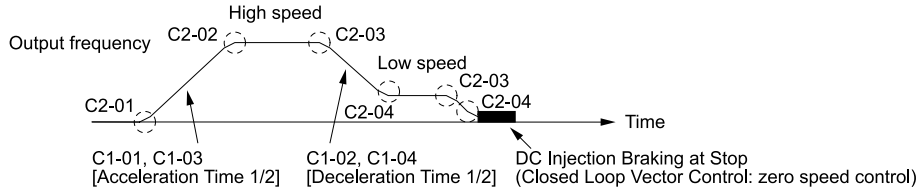
Adjustment Description	Parameter Number	Solution	Default Setting	Suggested Setting
<ul style="list-style-type: none"> <li>Torque, increase speed response</li> <li>Prevent hunting and oscillation</li> </ul>	C5-01 [ASR Proportional Gain 1]	<ul style="list-style-type: none"> <li>If torque and speed response are slow, increase the setting value.</li> <li>If there is hunting or oscillation, decrease the setting value.</li> </ul>	20.00	10.00 to 50.00
	C5-03 [ASR Proportional Gain 2]			
<ul style="list-style-type: none"> <li>Torque, increase speed response</li> <li>Prevent hunting and oscillation</li> </ul>	C5-02 [ASR Integral Time 1]	<ul style="list-style-type: none"> <li>If torque and speed response are slow, decrease the setting value.</li> <li>If there is hunting or oscillation, increase the setting value.</li> </ul>	0.500 s	0.300 to 1.000 seconds
	C5-04 [ASR Integral Time 2]			
Change the ASR proportional gain and ASR integral time in accordance with the output frequency.	C5-07 [ASR Gain Switchover Frequency]	If you cannot establish ASR proportional gain or integral time for low speed or high speed, switch as specified by the output frequency.	0.0 Hz (Do not switch)	0.0 to Maximum frequency
<ul style="list-style-type: none"> <li>Prevent hunting and oscillation</li> </ul>	C5-06 [ASR Delay Time]	<ul style="list-style-type: none"> <li>If there is unsatisfactory machine rigidity and oscillation is possible, increase the setting value.</li> </ul>	0.004 s	0.004 to 0.020 seconds

### Elevator Start/Stop and Accel/Decel Time Shock Reduction

Shock when you start and stop the elevator and when you accelerate and decelerate is an issue for passenger elevator applications. If shock has an effect on the quality of the ride, adjust these parameters:

**S-Curve Characteristics, Accel & Decel Time**

Adjustment Parameter	Name
C1-01, C1-03, C1-05, C1-07	Acceleration Time 1 to 4
C1-02, C1-04, C1-06, C1-08	Deceleration Time 1 to 4
C2-01	S-Curve Time @ Start of Accel
C2-02	S-Curve Time @ End of Accel
C2-03	S-Curve Time @ Start of Decel
C2-04	S-Curve Time @ End of Decel



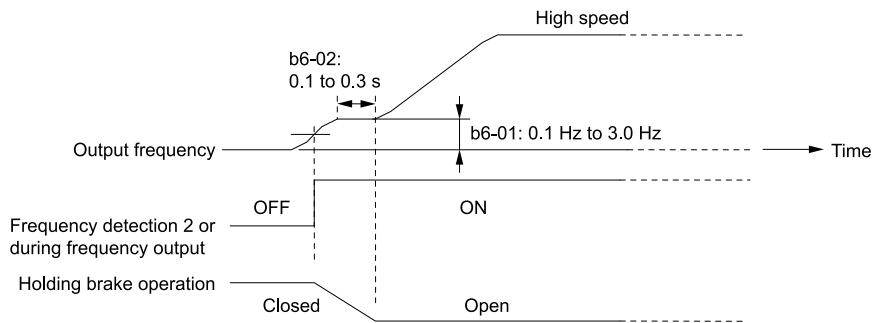
**Figure 11.5 S-curve Characteristics, Accel & Decel Time**

**Note:**

- When decreased operation times are necessary for the application, for example with cranes and hoists, do not use S-curve characteristic times.
- The default setting for C2-04 [S-Curve Time @ End of Decel] will be 0.00 seconds. The default setting for other S-curve characteristics will be 0.20 seconds. Set the acceleration/deceleration times and S-curve characteristic time correctly for acceleration/deceleration start up and end. The recommended setting of the S-curve characteristics time is 0.2 to 1.0 seconds.
- When you use the C1-11 [Accel/Decel Time Switchover Freq], you can switch the acceleration/deceleration rate automatically during acceleration/deceleration. The default setting is disabled.  
When the Output Frequency  $\geq$  C1-11, operate at the acceleration and deceleration times set in C1-01 and C1-02  
When the Output Frequency  $<$  C1-11, operate at the acceleration and deceleration times set in C1-07 and C1-08
- During low speed operation, if the Output Frequency  $<$  E1-09 [Minimum Output Frequency] in the S-Curve Time @ Start of Decel, the drive will cancel the S-curve characteristics and will do DC Inject Braking at Stop (zero speed control).

**Dwell Function at Start**

Adjustment Parameter	Name
b6-01	Dwell Reference at Start
b6-02	Dwell Time at Start
H2-xx = 5	Frequency Detection 2



**Figure 11.6 Dwell Function at Start**

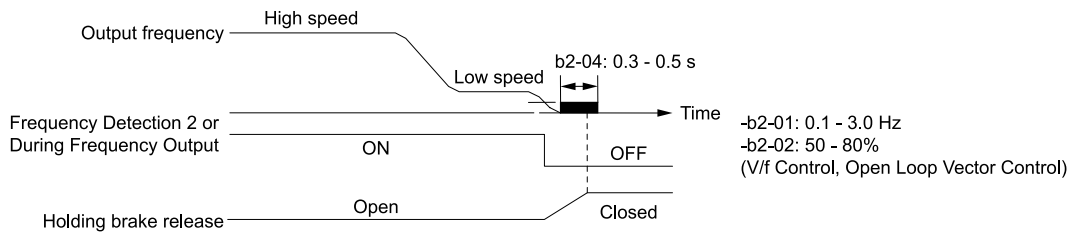
**Note:**

- If the mechanical operation of the holding brake is slow, use the Dwell Function at Start to prevent brake grinding (friction). Accelerate after the brake is fully open.
- When you use V/f Control and Open Loop Vector Control modes, set b6-01 [Dwell Reference at Start]  $>$  Frequency Detection 2 (brake open frequency).
- If the motor torque is not sufficient during start up, use the DC Inject Braking function to secure the motor current (torque) before you start the motor.  
-b2-02 [DC Injection Braking Current] recommended setting: 50% to 80% (V/f Control or Open Loop Vector Control)  
-b2-03 [DC Inject Braking Time at Start] recommended setting: 0.2 s to 0.5 s

### DC Injection Braking at Stop, Zero Speed Control Function

**NOTICE:** If you disconnect a drive when it is controlling the motor or during DC Injection Braking (Zero speed level), a voltage surge can trigger a fault. When you use an electromagnetic contactor between the drive and motor, set L8-07 = 1 or 2 [Output Phase Loss Protection Sel = Fault when one phase is lost, Fault when two phases are lost]. If it necessary to disconnect the motor and drive when you stop the elevator, as in Europe, fully close the holding brake and disconnect the drive during baseblock (i.e., while the baseblock signal is ON). This does not apply for emergency conditions.

Adjustment Parameter	Name
b2-01	DC Injection/Zero SpeedThreshold
b2-02	DC Injection Braking Current
b2-04	DC Inject Braking Time at Stop
H2-xx = 5	Frequency Detection 2



**Figure 11.7 DC Injection Braking at Stop, Zero Speed Control Function**

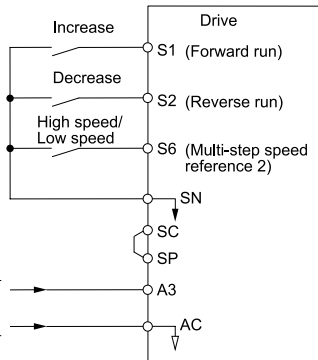
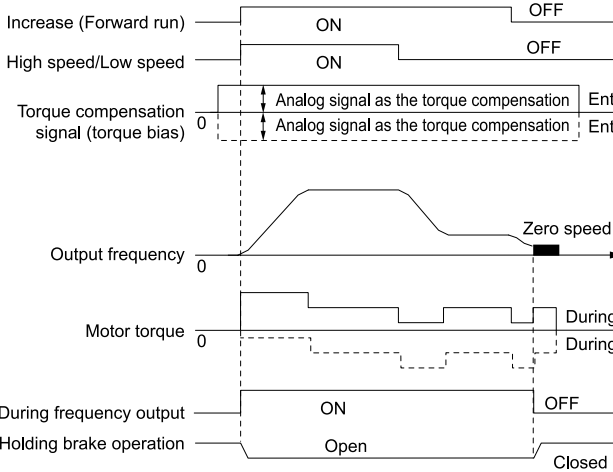
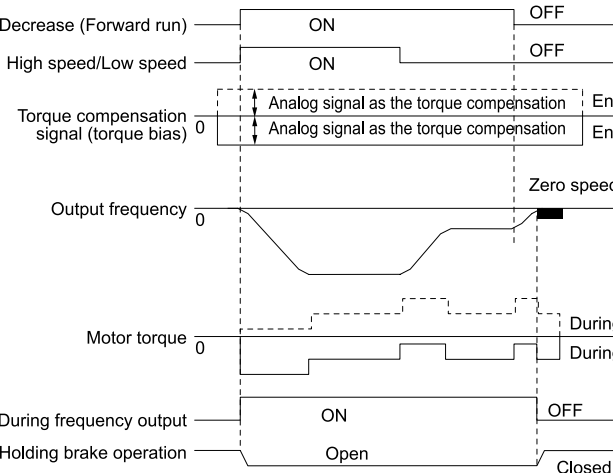
**Note:**

- If the mechanical operation of the holding brake is slow, use DC Injection Braking (zero speed control when set to closed loop vector) until the brake is fully closed to prevent rollback.
- If you cannot hold the load with DC Injection Braking when it is stopped in V/f Control and Open Loop Vector Control modes, use Dwell Function at Stop.
  - b6-03 [Dwell Reference at Stop]: Minimum output frequency to 3.0 Hz
  - When Frequency Detection 2 is OFF, it is less than L4-01 - L4-02 [Speed Agree Detection Level - Speed Agree Detection Width].
  - b6-04 [Dwell Time at Stop] suggested setting: 0.3 s to 0.5 s
  - b2-04 [DC Inject Braking Time at Stop] suggested setting: 0.0 s

### Torque Compensation (Torque Bias)

This function enters the torque compensation (torque bias) signal that matches a set load from the MFAI terminal in Closed Loop Vector Control to decrease the overshoot when you open and close the brake. You must detect the load and motoring/regeneration on the machine side before you use the function. If there is a polarity error, shock can increase.

## 11.2 A: Initialization Parameters

Item	Description
Sequence Circuit Configuration	 <p>H3-05 (Terminal A3 Signal Level Select) = 1 (-10 to +10 V)  H3-06 (Terminal A3 Function Selection) = 14  [Torque Compensation (Torque Bias)]  Fine tune by H3-07 and H3-08</p>
Time chart: Increase	<p>Enter the analog signal as the torque compensation (torque bias) signal as specified by the load quantity before drive operation until drive operation completes. The default setting is 10 V/100% torque.</p> <p>Enter a positive polarity during a motoring load, and enter a negative polarity during a regenerative load.</p> 
Time chart: Decrease	<p>Enter the analog signal as the torque compensation (torque bias) signal as specified by the load quantity before drive operation until drive operation completes. The default setting is 10 V/100% torque.</p> <p>Enter a negative polarity during a motoring load, and enter a positive polarity during a regenerative load.</p> 

### Note:

- Holds through an external source to not change the torque compensation signal during run. If you change the torque compensation signal during run, the motor can oscillate.
- When you set motor reverse to the increase command and set motor forward to the decrease command, the polarity of the torque compensation signal will reverse.

### Analog Input Filter Time Constant

When  $b1-01 = 1$  [Frequency Reference Selection 1 = Analog Input], it adds noise to the analog frequency reference during run.

- Minimize the effects of noise.

- Change H3-13 [*Analog Input Filter Time Constant*] to a range of 0.01 s to 0.10 s.

### Startup Current Check

When you do a test run, set L8-41 = 1 [*High Current Alarm Selection = Enabled*] and use U4-13 [*Peak Hold Current*] and a clamp ammeter with the machine under load and not under load to check the motor current during start up.

If the motor torque is not sufficient during start up or if the timing between the motor and the holding brake is unsatisfactory and causes the motor to lock, a large quantity of current will flow. If the current flow is more than 150% of the drive rated current, the heat stress on the IGBTs will decrease the service life of drive parts. In these conditions, adjust the parameters again and decrease the load to decrease the current to less than 150%.

To decrease the effects of heat stress, decrease the carrier frequency of the drive to 2.0 kHz to 2.5 kHz for applications where low audible noise is necessary.

### Overvoltage Suppression Function

If the overvoltage suppression function is used in elevator type applications, there is a risk of rollback and falls. Set L3-11 = 0 [*Overvoltage Suppression Select = Disabled*].

The overvoltage suppression function is designed to prevent an overvoltage trip in a situation in which a braking resistor is not used with a regenerative load. If the overvoltage suppression function is enabled, the regeneration torque reference within the drive is automatically controlled during regeneration.

#### Note:

When using the drive for applications such as high speed elevators with a speed of 2 ms or more and direct drive elevators, or when you need drives designed for cranes, contact Yaskawa or your Yaskawa sales representative.

## ■ A1-07: DriveWorksEZ Function Selection

No. (Hex.)	Name	Description	Default (Range)
A1-07 (0128)	DriveWorksEZ Function Selection	<input type="checkbox"/> V/f <input type="checkbox"/> CL-V/f <input type="checkbox"/> OLV <input type="checkbox"/> CLV <input type="checkbox"/> AOLV <input type="checkbox"/> OLV/PM <input type="checkbox"/> AOLV/PM <input type="checkbox"/> CLV/PM <input type="checkbox"/> EZOLV Sets the drive to operate with DriveWorksEZ.	0 (0 - 2)

DriveWorksEZ is a simple visual programming tool that lets you connect function blocks to customize the drive and add PLC functions.

#### Note:

- DriveWorksEZ will overwrite drive settings when it uses MFDI/MFDO and MFAI/MFAO. When you use DriveWorksEZ to make changes to the drive, the changes will stay after you disable DriveWorksEZ.
- For more information about DriveWorksEZ, contact Yaskawa or your nearest sales representative.

### 0 : DWEZ Disabled

### 1 : DWEZ Enabled

### 2 : Enabled/Disabled wDigital Input

Set H1-xx = 9F [*MFDI Function Select = DWEZ Disable*]. Deactivate the digital input to enable programs made with DriveWorksEZ and activate the terminal to disable the programs.

## ■ A1-11: Firmware Update Lock

No. (Hex.)	Name	Description	Default (Range)
A1-11 (111D) Expert	Firmware Update Lock	<input type="checkbox"/> V/f <input type="checkbox"/> CL-V/f <input type="checkbox"/> OLV <input type="checkbox"/> CLV <input type="checkbox"/> AOLV <input type="checkbox"/> OLV/PM <input type="checkbox"/> AOLV/PM <input type="checkbox"/> CLV/PM <input type="checkbox"/> EZOLV This function locks the drive firmware. When enabled, users cannot flash new drive firmware.	0 (0, 1)

### 0 : Disabled

Lock is disabled.

### 1 : Enabled

Lock is enabled.

■ **A1-12: Bluetooth ID**

No. (Hex.)	Name	Description	Default (Range)
A1-12 (1564)	Bluetooth ID	<div style="display: flex; justify-content: space-between; font-size: 0.8em; font-weight: bold; margin-bottom: 5px;"> <span>V/f</span> <span>CL-V/f</span> <span>OLV</span> <span>CLV</span> <span>AOLV</span> <span>OLV/PM</span> <span>AOLV/PM</span> <span>CLV/PM</span> <span>EZOLV</span> </div> Sets the password necessary to use Bluetooth to control the drive with a mobile device.	- (0000 - 9999)

◆ **A2: User Parameters**

You can register frequently used parameters and recently changed parameters here to access them quickly. You can show the registered parameters in [User Custom Parameters] in the main menu.

■ **A2-01 to A2-32: User Parameters 1 to 32**

No. (Hex.)	Name	Description	Default (Range)
A2-01 to A2-32 (0106 - 0125)	User Parameters 1 to 32	<div style="display: flex; justify-content: space-between; font-size: 0.8em; font-weight: bold; margin-bottom: 5px;"> <span>V/f</span> <span>CL-V/f</span> <span>OLV</span> <span>CLV</span> <span>AOLV</span> <span>OLV/PM</span> <span>AOLV/PM</span> <span>CLV/PM</span> <span>EZOLV</span> </div> You can select a maximum of 32 parameters for the drive and set them to parameters A2-01 to A2-32. The [User Parameters] section of the keypad main menu shows the set parameters. You can immediately access these set parameters.	Parameters in General-Purpose Setup Mode (Determined by A1-07)

**Note:**

- Settings for A2-01 to A2-32 change when the A1-06 [Application Preset] value changes.
- You must set A1-01 = 1 [Access Level Selection = User Parameters] to access parameters A2-01 to A2-32.
- When A1-07 = 1 or 2 [DriveWorksEZ Function Selection = DWEZ Enabled or Enabled/Disabled wDigital Input], the drive saves qx-xx [DriveWorksEZ Parameters] to A2-01 to A2-32.

The drive saves these parameters to A2-01 to A2-32.

- The drive saves a maximum of 32 parameters.

**Note:**

Set A1-01 = 2 [Advanced Level] or A1-01 = 3 [Expert Level] to register the necessary parameters.

- The drive automatically saves changed parameters to A2-17 to A2-32.

**Note:**

Set A2-33 = 1 [User Parameter Auto Selection = Enabled].

■ **A2-33: User Parameter Auto Selection**

No. (Hex.)	Name	Description	Default (Range)
A2-33 (0126)	User Parameter Auto Selection	<div style="display: flex; justify-content: space-between; font-size: 0.8em; font-weight: bold; margin-bottom: 5px;"> <span>V/f</span> <span>CL-V/f</span> <span>OLV</span> <span>CLV</span> <span>AOLV</span> <span>OLV/PM</span> <span>AOLV/PM</span> <span>CLV/PM</span> <span>EZOLV</span> </div> Sets the automatic save feature for changes to parameters A2-17 to A2-32 [User Parameters 17 to 32].	Determined by A1-06 (0, 1)

**0 : Disabled: Manual Entry Required**

Set User Parameters manually.

**1 : Enabled: Auto Save Recent Parm**

The drive automatically registers changed parameters to A2-17 to A2-32. The drive automatically saves the most recently changed parameter to A2-17, and saves a maximum of 16 parameters. After the drive registers 16 parameters, when you save a new parameter, the drive will remove a parameter from the User Parameter list to make space for the new parameter. The drive removes parameters with First In, First Out.

You can show the registered parameters in [User Custom Parameters] in the main menu.

**Note:**

In General-Purpose Setup Mode, the drive registers parameters starting from A2-27 because parameters A2-26 and lower are already registered by default.



## 11.3 b: Application

*b* parameters set the following functions.

- Frequency reference source/Run command source
- Stopping method settings
- DC Injection Braking
- Speed Search
- Timer Function
- PID control
- Dwell function
- Droop control
- Energy Savings Control
- Zero Servo Control

### ◆ b1: Operation Mode Selection

*b1* parameters set the operation mode for the drive.

#### ■ b1-01: Frequency Reference Selection 1

No. (Hex.)	Name	Description	Default (Range)
b1-01 (0180)	Frequency Reference Selection 1	 Sets the input method for the frequency reference.	1 (0 - 4)

Note:

- Push on the keypad to set the input mode to LOCAL and enter the frequency reference from the keypad.
- When the drive receives a Run command when the frequency reference is 0 Hz or less than the *E1-09* [Minimum Output Frequency] value, on the keypad will flash. Check the setting for the frequency reference input and enter a value more than or equal to the *E1-09* value.

#### 0 : Keypad

Use the keypad to enter the frequency reference.

Use and on the keypad to change the frequency reference.

#### 1 : Analog Input

Use MFAI terminals A1, A2, and A3 to input an analog frequency reference with a voltage or current input signal.

- Voltage Input  
Refer to [Table 11.22](#) to use a voltage signal input to one of the MFAI terminals.

Table 11.22 Frequency Reference Voltage Input

Terminal	Terminal Signal Level	Parameter Settings				Note
		Signal Level Selection	Function Selection	Gain	Bias	
A1	0 - 10 V	H3-01 = 0	H3-02 = 0 [Frequency Reference]	H3-03	H3-04	Set DIP switch S1-1 to "V" for voltage input.
	-10 - 10 V	H3-01 = 1				
A2	0 - 10 V	H3-09 = 0	H3-10 = 0 [Frequency Reference]	H3-11	H3-12	Set DIP switch S1-2 to "V" for voltage input.
	-10 - 10 V	H3-09 = 1				
A3	0 - 10 V	H3-05 = 0	H3-06 = 0 [Frequency Reference]	H3-07	H3-08	Set DIP switch S1-3 to "V" for voltage input. Set DIP switch S4 to "AI" for analog input.
	-10 - 10 V	H3-05 = 1				

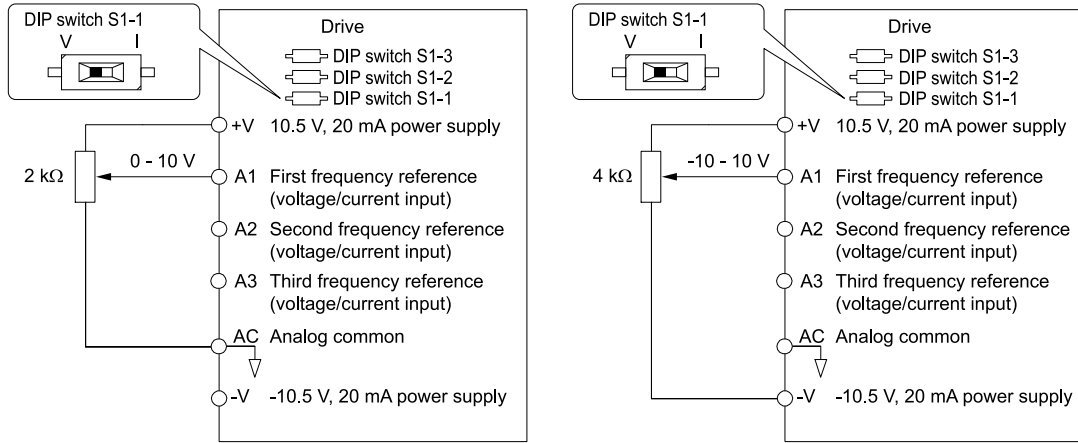


Figure 11.8 Example of Setting the Frequency Reference with a Voltage Signal to Terminal A1

**Note:**

You can also use this diagram to wire terminals A2 and A3.

• **Current Input**

Refer to Table 11.23 to use a current signal input to one of the MFAI terminals.

Table 11.23 Frequency Reference Current Input

Terminal	Signal Level	Parameter Settings				Note
		Signal Level Selection	Function Selection	Gain	Bias	
A1	4 mA to 20 mA	H3-01 = 2	H3-02 = 0	H3-03	H3-04	Set DIP switch S1-1 to "I" for current input.
	0 - 20 mA	H3-01 = 3	[Frequency Reference]			
A2	4 mA to 20 mA	H3-09 = 2	H3-10 = 0	H3-11	H3-12	Set DIP switch S1-2 to "I" for current input.
	0 - 20 mA	H3-09 = 3	[Frequency Reference]			
A3	4 mA to 20 mA	H3-05 = 2	H3-06 = 0	H3-07	H3-08	Set DIP switch S1-3 to "I" for current input. Set DIP switch S4 to "AI" for analog input.
	0 - 20 mA	H3-05 = 3	[Frequency Reference]			

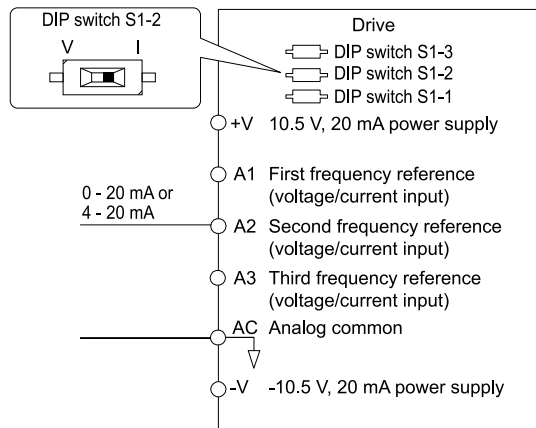


Figure 11.9 Example of Setting the Frequency Reference with a Current Signal to Terminal A2

**Note:**

You can also use this diagram to wire terminals A1 and A3.

Changing between master and auxiliary frequency references

Use the multi-step speed reference function to change the frequency reference input between terminals A1, A2, and A3.

**2 : Memobus/Modbus Communications**

Use MEMOBUS/Modbus communications to enter the frequency reference.

**3 : Option PCB**

Use a communications option card or input option card connected to the drive to enter the frequency reference.

Refer to the instruction manual included with the option card to install and set the option card.

**Note:**

If  $b1-01 = 3$  but no connected option card, then  $oPE05$  [Run Cmd/Freq Ref Source Sel Err] will flash on the keypad.










#### 4 : Pulse Train Input

Use a pulse train signal from the pulse train input terminal RP to enter the frequency reference.

Do this procedure to make sure that the pulse train signal is operating correctly.

1. Set  $b1-01 = 4$ ,  $H6-01 = 0$  [Terminal RP Pulse Train Function = Frequency Reference].
2. Set  $H6-02$  [Terminal RP Frequency Scaling] to the number of pulses that determine 100% of the frequency reference.
3. Enter a pulse train signal on the terminal RP and make sure that the keypad shows a correct frequency reference.

#### ■ b1-02: Run Command Selection 1

No. (Hex.)	Name	Description	Default (Range)
b1-02 (0181)	Run Command Selection 1	         Sets the input method for the Run command.	1 (0 - 3)

#### 0 : Keypad

Use the keypad to enter the Run command.

You can use the JOG operation or the FWD/REV commands from the keypad.

**Note:**



will illuminate when the keypad is the Run command source.

#### 1 : Digital Input

Use the control circuit terminals to enter the Run command. Select the input method for the Run command with an  $H1-xx$  parameter.

Set  $H1-xx = 0, 40$  to  $43$  [3-Wire Sequence, Run Command (2-Wire Sequence)]. The default setting is 2-wire sequence 1.

- 2-wire Sequence 1  
This sequence has two input types: FWD/Stop and REV/Stop. Set  $A1-03 = 2220$  [Initialize Parameters = 2-Wire Initialization] to initialize the drive and set terminals S1 and S2 for a 2-wire sequence.
- 2-wire Sequence 2  
This sequence has two input types: Run/Stop and FWD/REV.
- 3-Wire Sequence  
This sequence has three input types: Run, Stop, and FWD/REV. Set  $A1-03 = 3330$  [Initialize Parameters = 3-Wire Initialization] to initialize the drive and set terminals S1, S2, and S5 for a 3-wire sequence.

#### 2 : Memobus/Modbus Communications

Use MEMOBUS/Modbus communications to enter the Run command.

#### 3 : Option PCB










Use a communications option card or input option card connected to the drive to enter the Run command.

Refer to the instruction manual included with the option card to install and set the option card.

**Note:**

If  $b1-02 = 3$  but no connected option card, then  $oPE05$  [Run Cmd/Freq Ref Source Sel Err] will flash on the keypad.

#### ■ b1-03: Stopping Method Selection

No. (Hex.)	Name	Description	Default (Range)
b1-03 (0182)	Stopping Method Selection	         Sets the method to stop the motor after removing a Run command or entering a Stop command.	0 (0 - 3, 9)

**Note:**

The setting range is 0, 1, and 3 when  $A1-02 = 3, 4, 5, 6, 7$ , or  $8$  [Control Method Selection = Closed Loop Vector, Advanced Open Loop Vector, PM Open Loop Vector, PM Advanced Open Loop Vector, PM Closed Loop Vector, or EZ Vector Control].

Select the applicable stopping method for the application from these four options:

**0 : Ramp to Stop**

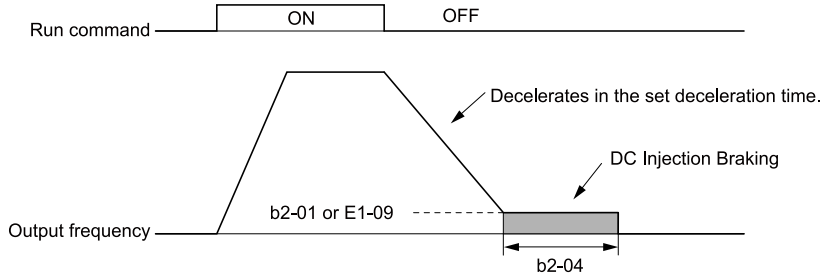
Enter the Stop command or turn OFF the Run command to decelerate the motor to stop.

The drive ramps the motor to stop as specified by the deceleration time. The default setting for the deceleration time is *C1-02 [Deceleration Time 1]*. The actual deceleration time changes as the load conditions change (for example, mechanical loss and inertia).

If the output frequency is less than or equal to the value set in *b2-01 [DC Injection/Zero SpeedThreshold]* during deceleration, the drive will do DC Injection Braking, Zero Speed Control, or Short Circuit Braking, as specified by the control method.

• **Ramp to Stop with V/f, AOLV, CL-V/f, and OLV Control Methods**

Parameter *b2-01* sets the frequency to start DC Injection Braking at stop. If the output frequency is less than or equal to the value set in *b2-01* during deceleration, then the drive will perform DC Injection Braking for the time set in *b2-04 [DC Inject Braking Time at Stop]*.



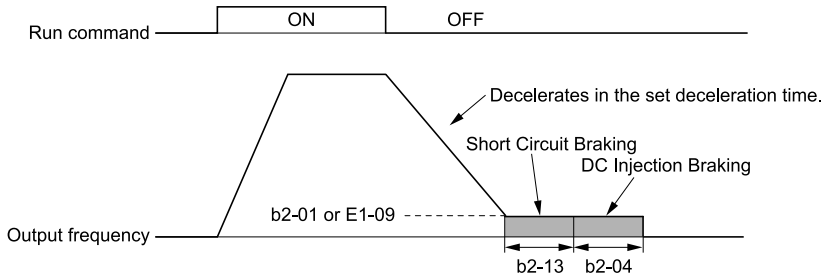
**Figure 11.10 Ramp to Stop with V/f, AOLV, CL-V/f, and OLV Control Methods**

**Note:**

When  $b2-01 \leq E1-09$  [Minimum Output Frequency], the drive will start DC Injection Braking from the frequency set in *E1-09*.

• **Ramp to Stop with CLV/PM, AOLV/PM, and EZOLV Control Methods**

Parameter *b2-01* sets the frequency to start Short Circuit Braking. When the output frequency is less than or equal to the value set in *b2-01* during deceleration, then the drive will do Short Circuit Braking for the time set in *b2-13 [Short Circuit Brake Time @ Stop]*. When  $b2-04 \neq 0$ , the drive will do DC Injection Braking for the time set in *b2-04* when Short Circuit Braking is complete.



**Figure 11.11 Ramp to Stop with CLV/PM, AOLV/PM, and EZOLV Control Methods**

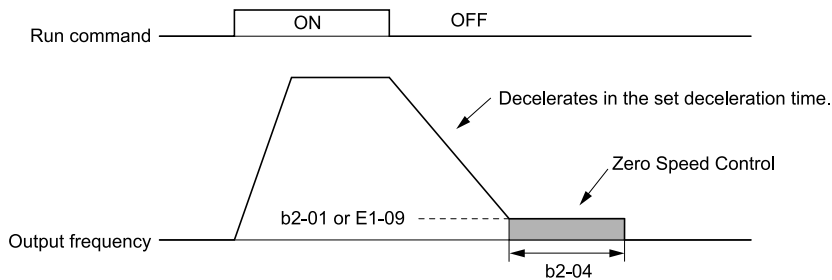
**Note:**

When  $b2-01 \leq E1-09$ , the drive will start Short Circuit Braking from the frequency set in *E1-09*.

If  $b2-01 = 0 \text{ Hz}$  and  $E1-09 = 0 \text{ Hz}$ , the drive will not do Short Circuit Braking.

• **Ramp to Stop in CLV and CLV/PM Control Methods**

Parameter *b2-01* sets the frequency to start Zero Speed Control at stop. When the output frequency is less than or equal to the value set in *b2-01* during deceleration, the drive will do Zero Speed Control for the time set in *b2-04*.



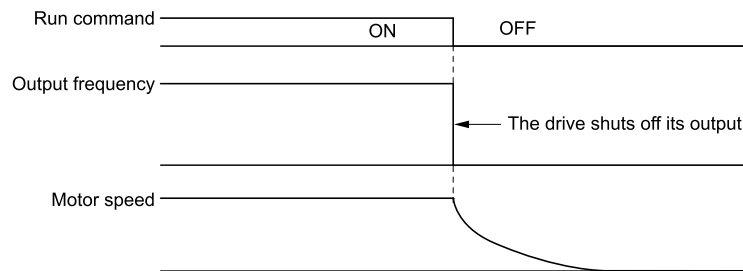
**Figure 11.12 Ramp to Stop in CLV and CLV/PM Control Methods**

**Note:**

When if  $b2-01 \leq E1-09$ , the drive will start Zero Speed Control from the frequency set in  $E1-09$ .

**1 : Coast to Stop**

Enter the Stop command or turn OFF the Run command and turn OFF drive output and coast the motor to stop. Load conditions will have an effect on the deceleration rate as the motor coasts to stop (for example, mechanical loss and inertia).



**Figure 11.13 Coast to Stop**

**Note:**

The drive ignores the Run command for the time set in  $L2-03$  [Minimum Baseblock Time] when the Stop command is entered or when the Run command is switched OFF. Do not enter the Run command until the motor comes to a complete stop. Use DC Injection or Speed Search to restart the motor before it stops.

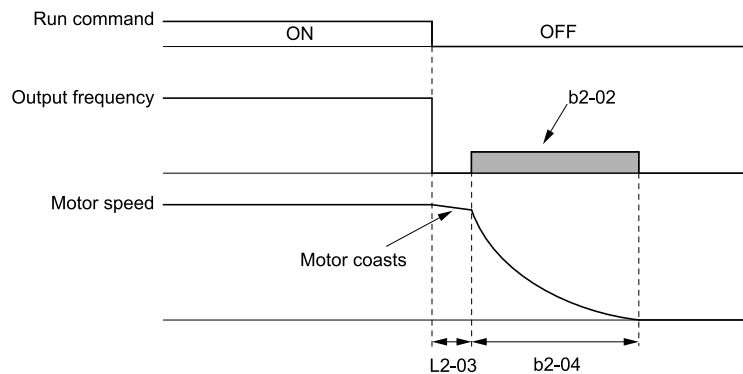
**2 : DC Injection Braking to Stop**

Enter the Stop command or turn OFF the Run command and turn OFF drive output for the time set in  $L2-03$ . The drive waits for the minimum baseblock time and then injects the amount of DC current into the motor set in  $b2-02$  [DC Injection Braking Current] to stop the motor with DC current.

DC Injection Braking stops the motor more quickly than coast to stop.

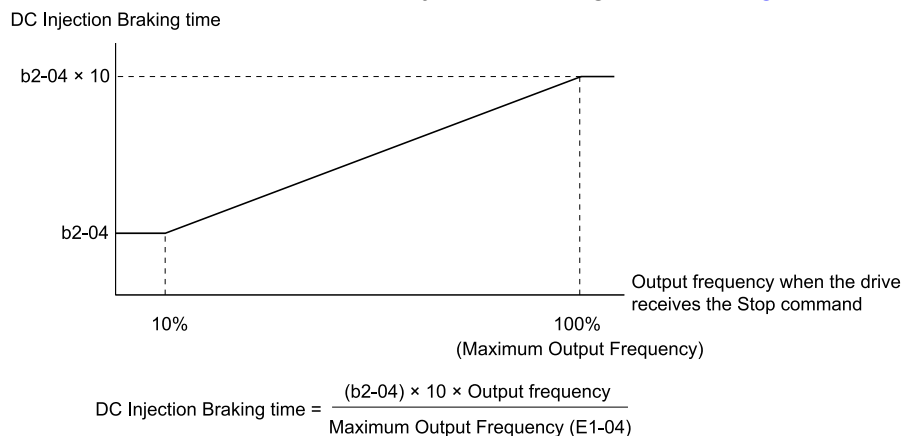
**Note:**

If  $A1-02 = 3, 4, 5, 6, \text{ or } 7$ , DC Injection Braking to Stop is not available.



**Figure 11.14 DC Injection Braking to Stop**

The value set in  $b2-04$  and the output frequency when the drive receives the Stop command determine the DC Injection Braking time. The drive calculates the DC Injection Braking time as in [Figure 11.15](#).



**Figure 11.15 DC Injection Braking Time and Output Frequency**

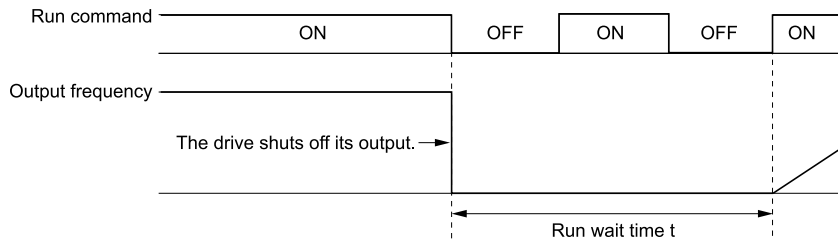
**Note:**

Set L2-03 to a high value that will not trigger *oC* [Overcurrent] when the drive uses DC Injection Braking to stop the motor.

**3 : Coast to Stop with Timer**

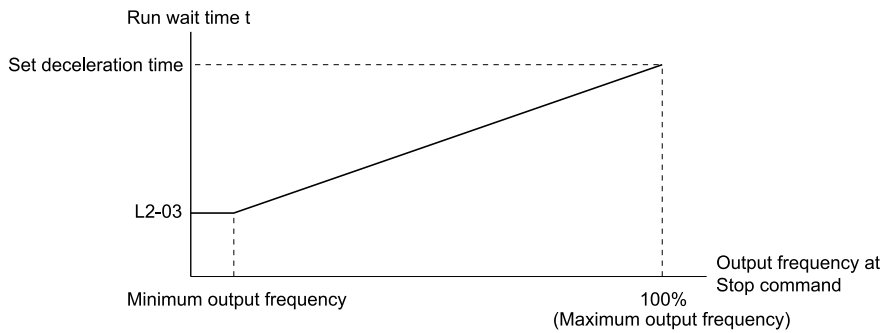
Enter the Stop command or turn OFF the Run command and turn OFF drive output and coast the motor to stop. The drive ignores the Run command until the “Run wait time”  $t$  is expired.

To start the drive again, enter the Run command after the “Run wait time”  $t$  is expired.



**Figure 11.16 Coast to Stop with Timer**

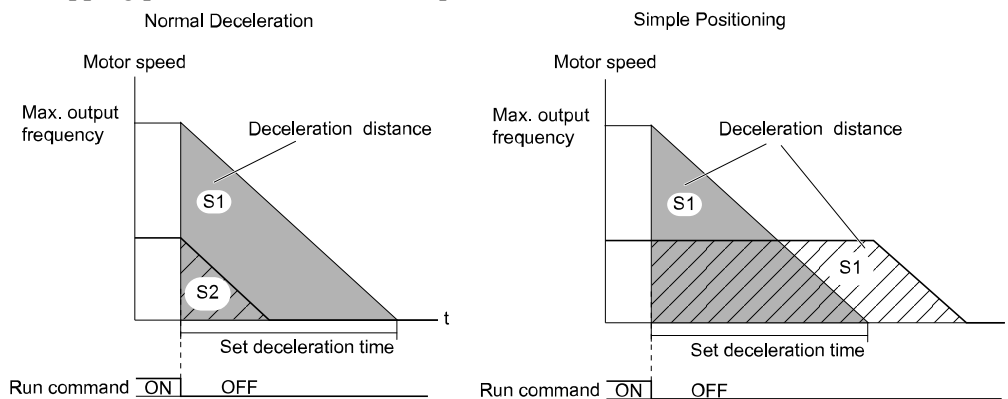
The active deceleration time and the output frequency when drive receives the Stop command determine the length of “Run wait time”  $t$ .



**Figure 11.17 Run Wait Time and Output Frequency**

**9 : Stop with Constant Distance**

Enter the Stop command or turn OFF the Run command for the drive to always decelerate for the same distance. The drive uses the active deceleration time and the value set in E1-04 [Maximum Output Frequency] to calculate stopping distance S1. The drive holds its current speed when stopping from a frequency less than the maximum speed. When the distance covered is equal to S1 minus S2, the drive ramps to stop in the current deceleration time. Adjust the stopping precision with d4-12 [Stop Position Gain].



**Figure 11.18 Deceleration When Set for Stop in Position**

**Note:**

Note these points when setting Stop in Position.

- The drive uses the deceleration time that was active when the drive received the Stop command or when the Run command was turned OFF to calculate the stop time. If you change the deceleration time during deceleration, the positioning will not be accurate.
- Set  $b6-03 = 0.0$  [Dwell Reference at Stop = 0.0],  $b6-04 = 0.0$  [Dwell Time at Stop = 0.0 s].
- The KEB Ride-Thru function is not available. Set  $H1-xx \neq 65, 66, 7A, 7B$  [MFDI Function Select = KEB Ride-Thru 1/2 Activate (N.O./N.C.)].
- Set  $L3-04 = 0$  [Stall Prevention during Decel = Disabled]. A dynamic braking option can be necessary for regenerative loads.
- Set  $L3-11 = 0$  [Overvoltage Suppression Select = Disabled].
- The High Slip Braking function is not available. Set  $H1-xx \neq 68$  [MFDI Function Select  $\neq$  High Slip Braking (HSB) Activate].
- Set  $C2-03, C2-04 = 0.00$  [S-Curve Time @ Start of Decel, S-Curve Time @ End of Decel = 0.00 s].

## ■ b1-04: Reverse Operation Selection

No. (Hex.)	Name	Description	Default (Range)
b1-04 (0183)	Reverse Operation Selection	<div style="display: flex; gap: 5px;"> <span>V/f</span> <span>CL-V/f</span> <span>OLV</span> <span>CLV</span> <span>AOLV</span> <span>OLV/PM</span> <span>AOLV/PM</span> <span>CLV/PM</span> <span>EZOLV</span> </div> Sets the reverse operation function. Disable reverse operation in fan or pump applications where reverse rotation is dangerous.	0 (0, 1)

When reverse operation is prohibited, the drive will not accept a Reverse operation command.

### 0 : Reverse Enabled

The drive will accept a Reverse operation command.

### 1 : Reverse Disabled

The drive will not accept a Reverse operation command.

## ■ b1-05: Operation Below Minimum Freq

No. (Hex.)	Name	Description	Default (Range)
b1-05 (0184)	Operation Below Minimum Freq	<div style="display: flex; gap: 5px;"> <span>V/f</span> <span>CL-V/f</span> <span>OLV</span> <span>CLV</span> <span>AOLV</span> <span>OLV/PM</span> <span>AOLV/PM</span> <span>CLV/PM</span> <span>EZOLV</span> </div> Sets the drive operation when the frequency reference decreases to less than the value set in $E1-09$ [Minimum Output Frequency].	0 (0 - 3)

### 0 : Operate at Frequency Reference

When the frequency reference is less than the value set in  $E1-09$ , the drive will continue to operate the motor as specified by the frequency reference.

If the motor speed is less than or equal to the value set in  $b2-01$  [DC Injection/Zero Speed Threshold] when you enter the Stop command (or deactivate the Run command), the drive will do Zero Speed Control for the time set in  $b2-04$  [DC Inject Braking Time at Stop] and then turn OFF its output.

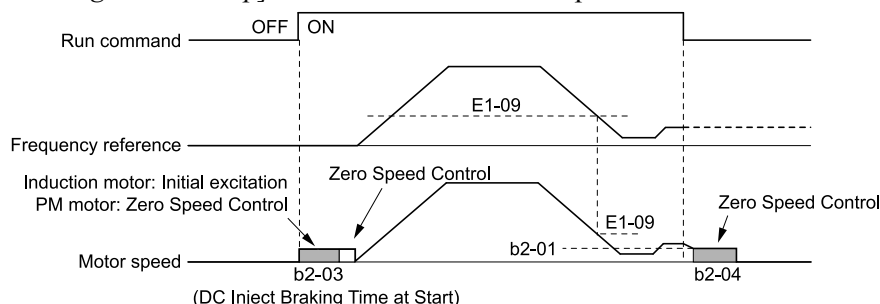


Figure 11.19 Operate at the Frequency Reference

### 1 : Baseblock (Motor Coasts)

If the frequency reference is less than the value set in  $E1-09$ , the drive stops motor voltage output and the motor coasts to stop. If the motor speed is less than or equal to the value set in  $b2-01$ , then the drive will do Zero Speed Control for the time set in  $b2-04$ .

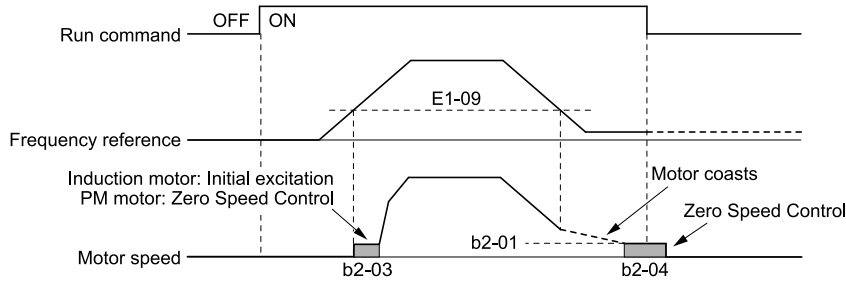


Figure 11.20 Baseblock (Motor Coasts)

**2 : Operate at Minimum Frequency**

The drive operates the motor at the minimum frequency reference set in *E1-09* and the Run command is still enabled.

The drive decelerates the motor when the Stop command is entered (or when the Run command is switched OFF). If the motor speed falls below or is equal to the value set in *b2-01*, then the drive will perform Zero Speed Control for the time set in *b2-04*.

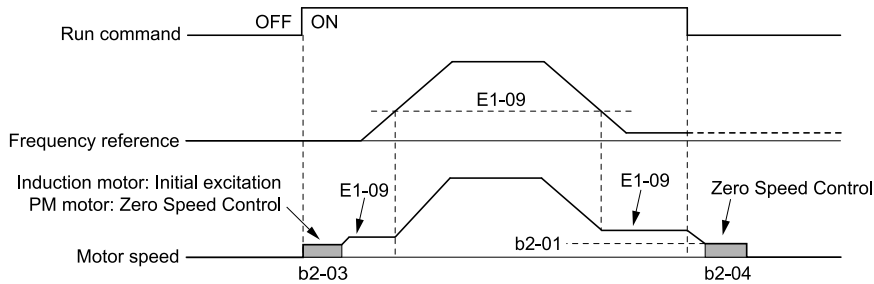


Figure 11.21 Operate at Minimum Frequency

**3 : Operate at Zero Speed**

The drive performs Zero Speed Control when the frequency reference falls below the value set in *E1-09*.

The drive performs Zero Speed Control again for the time set in *b2-04* when the Stop command is entered (or when the Run command is switched OFF).

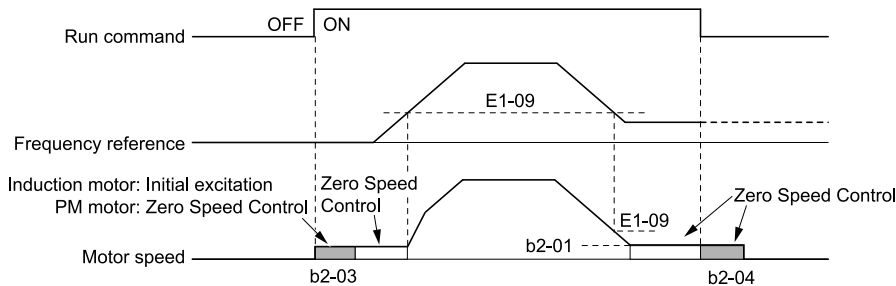


Figure 11.22 Operate at Zero Speed

**■ b1-06: Digital Input Reading**

No. (Hex.)	Name	Description	Default (Range)
b1-06 (0185)	Digital Input Reading	<span style="background-color: black; color: white; padding: 2px;">V/f</span> <span style="background-color: black; color: white; padding: 2px;">CL-V/f</span> <span style="background-color: black; color: white; padding: 2px;">OLV</span> <span style="background-color: black; color: white; padding: 2px;">CLV</span> <span style="background-color: black; color: white; padding: 2px;">AOLV</span> <span style="background-color: black; color: white; padding: 2px;">OLV/PM</span> <span style="background-color: black; color: white; padding: 2px;">AOLV/PM</span> <span style="background-color: black; color: white; padding: 2px;">CLV/PM</span> <span style="background-color: black; color: white; padding: 2px;">EZOLV</span> <p>Sets the number of times that the drive reads the sequence input command to prevent problems from electrical interference.</p>	1 (0, 1)

**0 : Single Scan**

The drive reads the terminal status one time. The drive immediately reads all changes to the terminal status. This setting lets the drive quickly respond to changes in the sequence, but electrical interference can cause problems.

**1 : Double Scan**

The drive reads the terminal status two times. The drive reads all changes to the terminal status two times to make sure that the reading is the same.



The drive responds more slowly than when it reads the sequence one time, but this setting prevents electrical interference problems.

### ■ b1-07: LOCAL/REMOTE Run Selection

No. (Hex.)	Name	Description	Default (Range)
b1-07 (0186)	LOCAL/REMOTE Run Selection	<b>V/f</b> <b>CL-V/f</b> <b>OLV</b> <b>CLV</b> <b>AOLV</b> <b>OLV/PM</b> <b>AOLV/PM</b> <b>CLV/PM</b> <b>EZOLV</b> Sets drive response to an existing Run command when the drive receives a second Run command from a different location.	0 (0, 1)

This parameter interlocks the drive to help prevent accidents that can occur if the motor starts to rotate because the Run command source changed.

To switch the RUN command source, push **LORE** on the keypad or set  $HI-xx = 1, 2$  [*MFDI Function Select = LOCAL/REMOTE Selection, External Reference 1/2 Selection*] and turn the terminal ON/OFF.

#### 0 : Disregard Existing RUN Command

If a Run command is enabled when you switch between Run command sources, the drive will not operate the motor.

When the drive is operating the motor, turn OFF the Run command to stop the motor. Enter the Run command again to start operation.

#### 1 : Accept Existing RUN Command

If a Run command is enabled when you switch between Run command sources, the drive will start to operate the motor or continue to operate the motor.

**WARNING! Sudden Movement Hazard.**

When using a 3-Wire sequence:

- Set the drive for 3-Wire sequence.
- Set  $b1-17 = 0$  [Run Command at Power Up = Disregard Existing RUN Command]
- Wire the drive for 3-Wire sequence.

If these three conditions are correct, the motor can rotate in reverse when energizing the drive:

- The drive is wired for 3-Wire sequence.
- The drive is set for a 2-Wire sequence (default).
- $b1-17 = 1$  [Accept Existing RUN Command]

Failure to obey can cause death or serious injury from moving equipment.

### ■ b1-08: Run Command Select in PRG Mode

No. (Hex.)	Name	Description	Default (Range)
b1-08 (0187)	Run Command Select in PRG Mode	<b>V/f</b> <b>CL-V/f</b> <b>OLV</b> <b>CLV</b> <b>AOLV</b> <b>OLV/PM</b> <b>AOLV/PM</b> <b>CLV/PM</b> <b>EZOLV</b> Sets the conditions for the drive to accept a Run command entered from an external source when using the keypad to set parameters.	0 (0 - 2)

As a safety precaution, when the drive is in Programming Mode, it will not respond to a Run command.

This parameter helps prevent accidents that can occur if the motor starts to rotate because the drive received a Run command from an external source while the user is programming the drive. You can also set the drive to not show the Programming Mode when a Run command is active.

**Note:**

Refer to this table for Drive Mode and Programming Mode functions.

Mode	Keypad Screen	Function
Drive Mode	Monitors	Sets monitor display.
Programming Mode	Parameters	Changes parameter settings.
	User Custom Parameters	Shows the User Parameters.
	Parameter Backup/Restore	Saves parameters to the keypad as backup.
	Modified Parameters/Fault Log	Shows modified parameters and fault history.
	Auto-Tuning	Auto-Tunes the drive.
	Initial Setup	Changes initial settings.
	Diagnostic Tools	Sets data logs and backlight.

#### 0 : Disregard RUN while Programming

The drive rejects the Run command while in Programming Mode.

**1 : Accept RUN while Programming**

The drive accepts a Run command entered from an external source while in Programming Mode.

**2 : Allow Programming Only at Stop**

The drive does not let the user enter Programming Mode when the drive is operating. The drive does not show the Programming Mode when a Run command is active.

■ **b1-14: Phase Order Selection**

No. (Hex.)	Name	Description	Default (Range)
b1-14 (01C3)	Phase Order Selection	<div style="display: flex; justify-content: space-between; font-size: small;"> <span>V/f</span> <span>CL-V/f</span> <span>OLV</span> <span>CLV</span> <span>AOLV</span> <span>OLV/PM</span> <span>AOLV/PM</span> <span>CLV/PM</span> <span>EZOLV</span> </div> <p>Sets the phase order for output terminals U/T1, V/T2, and W/T3. This parameter can align the Forward Run command from the drive and the forward direction of the motor without changing wiring.</p>	0 (0, 1)

**0 : Standard**

**1 : Switch Phase Order**

■ **b1-15: Frequency Reference Selection 2**

No. (Hex.)	Name	Description	Default (Range)
b1-15 (01C4)	Frequency Reference Selection 2	<div style="display: flex; justify-content: space-between; font-size: small;"> <span>V/f</span> <span>CL-V/f</span> <span>OLV</span> <span>CLV</span> <span>AOLV</span> <span>OLV/PM</span> <span>AOLV/PM</span> <span>CLV/PM</span> <span>EZOLV</span> </div> <p>Sets the input method for frequency reference 2.</p>	0 (0 - 4)

This parameter is enabled when  $H1-xx = 2$  [*MFDI Function Select = External Reference 1/2 Selection*] is activated.

**Note:**

- Push **LO/RE** on the keypad to set the input mode to LOCAL and enter the frequency reference from the keypad.
- When the drive receives a Run command when the frequency reference is 0 Hz or less than the  $E1-09$  [*Minimum Output Frequency*] value, the **RUN** on the keypad will flash. Check the setting for the frequency reference input and enter a value more than or equal to the  $E1-09$  value.

**0 : Keypad**

Use the keypad to enter the frequency reference.

Use **▲** and **▼** on the keypad to change the frequency reference.

**1 : Analog Input**

Use MFAI terminals A1, A2, and A3 to input an analog frequency reference with a voltage or current input signal.

- **Voltage Input**  
Refer to [Table 11.24](#) to use a voltage signal input to one of the MFAI terminals.

**Table 11.24 Frequency Reference Voltage Input**

Terminal	Terminal Signal Level	Parameter Settings				Note
		Signal Level Selection	Function Selection	Gain	Bias	
A1	0 - 10 V	H3-01 = 0	H3-02 = 0	H3-03	H3-04	Set DIP switch S1-1 to "V" for voltage input.
	-10 - +10 V	H3-01 = 1	[Frequency Bias]			
A2	0 - 10 V	H3-09 = 0	H3-10 = 0	H3-11	H3-12	Set DIP switch S1-2 to "V" for voltage input.
	-10 - +10 V	H3-09 = 1	[Frequency Bias]			
A3	0 - 10 V	H3-05 = 0	H3-06 = 0	H3-07	H3-08	Set DIP switch S1-3 to "V" for voltage input. Set DIP switch S4 to "AI" for analog input.
	-10 - +10 V	H3-05 = 1	[Frequency Bias]			

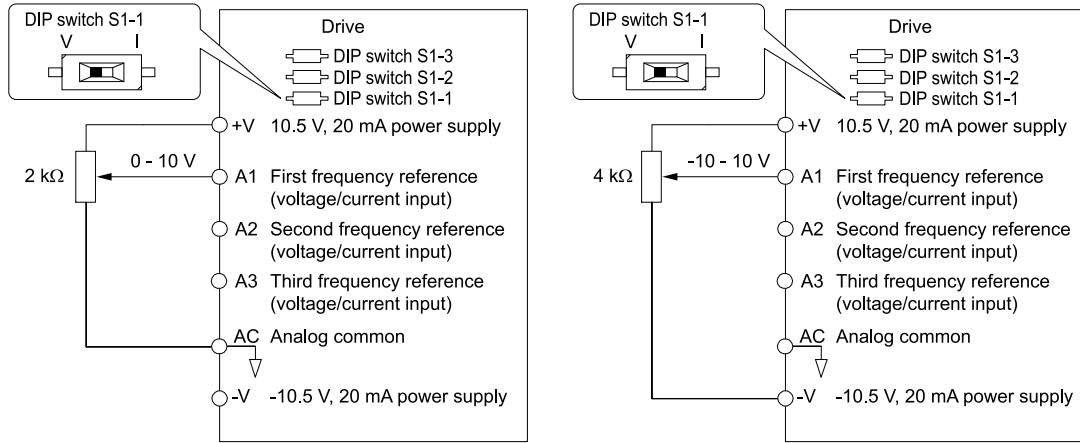


Figure 11.23 Example of Setting the Frequency Reference with a Voltage Signal to Terminal A1

**Note:**

You can also use this diagram to wire terminals A2 and A3.

• **Current Input**

Refer to Table 11.25 to use a current signal input to one of the MFAI terminals.

Table 11.25 Frequency Reference Current Input

Terminal	Signal Level	Parameter Settings				Note
		Signal Level Selection	Function Selection	Gain	Bias	
A1	4 - 20 mA	H3-01 = 2	H3-02 = 0 [Frequency Bias]	H3-03	H3-04	Set DIP switch S1-1 to "I" for current input.
	0 - 20 mA	H3-01 = 3				
A2	4 - 20 mA	H3-09 = 2	H3-10 = 0 [Frequency Bias]	H3-11	H3-12	Set DIP switch S1-2 to "I" for current input.
	0 - 20 mA	H3-09 = 3				
A3	4 - 20 mA	H3-05 = 2	H3-06 = 0 [Frequency Bias]	H3-07	H3-08	Set DIP switch S1-3 to "I" for current input. Set DIP switch S4 to "AI" for analog input.
	0 - 20 mA	H3-05 = 3				

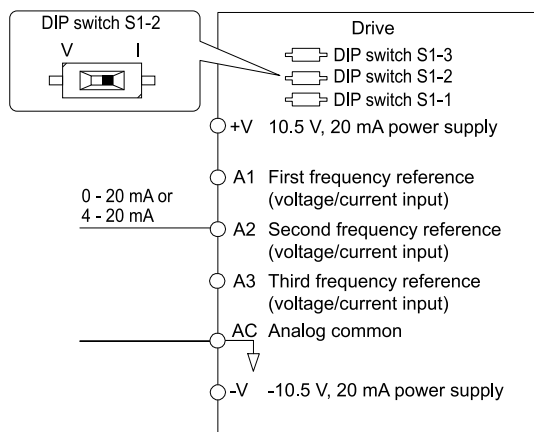


Figure 11.24 Example of Setting the Frequency Reference with a Current Signal to Terminal A2

**Note:**

You can also use this diagram to wire terminals A1 and A3.

Changing between Master and Auxiliary Frequency References

Use the multi-step speed reference function to change the frequency reference input between terminals A1, A2, and A3.

**2 : Memobus/Modbus Communications**

Use MEMOBUS/Modbus communications to enter the frequency reference.

**3 : Option PCB**

## 11.3 b: Application

Use a communications option card or input option card connected to the drive to enter the frequency reference. Refer to the instruction manual included with the option card to install and set the option card.

**Note:**

If  $b1-01 = 3$  but no connected option card, then  $oPE05$  [Run Cmd/Freq Ref Source Sel Err] will flash on the keypad.


### 4 : Pulse Train Input

Use a pulse train signal from the pulse train input terminal RP to enter the frequency reference.

Do this procedure to make sure that the pulse train signal is operating correctly.

1. Set  $b1-01 = 4$ ,  $H6-01 = 0$  [Terminal RP Pulse Train Function = Frequency Reference].
2. Set  $H6-02$  [Terminal RP Frequency Scaling] to the number of pulses that determine 100% of the frequency reference.
3. Enter a pulse train signal on the terminal RP and make sure that the keypad shows a correct frequency reference.

### ■ b1-16: Run Command Selection 2

No. (Hex.)	Name	Description	Default (Range)
b1-16 (01C5)	Run Command Selection 2	 Sets the input method for Run Command 2 when the user switches the control circuit terminals ON/OFF to change the Run command source.	0 (0 - 3)

This parameter is enabled when  $H1-xx = 2$  [MFDI Function Select = External Reference 1/2 Selection] is activated.

### 0 : Keypad

Use the keypad to enter the Run command.

You can use the JOG operation or the FWD/REV commands from the keypad.

**Note:**



will illuminate when the keypad is the Run command source.

### 1 : Digital Input

Use the control circuit terminals to enter the Run command. Select the input method for the Run command with an  $H1-xx$  parameter

Set  $H1-xx = 0, 40$  to  $43$  [3-Wire Sequence, Run Command (2-Wire Sequence)]. The default setting is 2-wire sequence 1.

- 2-wire Sequence 1  
This sequence has two input types: FWD/Stop and REV/Stop. Set  $A1-03 = 2220$  [Initialize Parameters = 2-Wire Initialization] to initialize the drive and set terminals S1 and S2 for a 2-wire sequence.
- 2-wire Sequence 2  
This sequence has two input types: Run/Stop and FWD/REV.
- 3-Wire Sequence  
This sequence has three input types: Run, Stop, and FWD/REV. Set  $A1-03 = 3330$  [Initialize Parameters = 3-Wire Initialization] to initialize the drive and set terminals S1, S2, and S5 for a 3-wire sequence.

### 2 : Memobus/Modbus Communications

Use MEMOBUS/Modbus communications to enter the Run command.

### 3 : Option PCB

Use a communications option card or input option card connected to the drive to enter the Run command.

Refer to the instruction manual included with the option card to install and set the option card.

**Note:**

If  $b1-02 = 3$  but no connected option card, then  $oPE05$  [Run Cmd/Freq Ref Source Sel Err] will flash on the keypad.

## ■ b1-17: Run Command at Power Up


No. (Hex.)	Name	Description	Default (Range)
b1-17 (01C6)	Run Command at Power Up	<div style="display: flex; justify-content: space-between; font-size: small;"> <span>V/f</span> <span>CL-V/f</span> <span>OLV</span> <span>CLV</span> <span>AOLV</span> <span>OLV/PM</span> <span>AOLV/PM</span> <span>CLV/PM</span> <span>EZOLV</span> </div> <p>Sets drive response when energizing a drive that has an external Run command. Set this parameter in applications where energizing or de-energizing the drive enables the Run command.</p>	0 (0, 1)

### 0 : Disregard Existing RUN Command

The drive does not start to operate the application when the power is switched ON, even when there is an existing Run command.

Enter the Run command again to operate the application.

Note:

When you energize the drive, the  light on the keypad will flash quickly if the Run command is already enabled from an external source.

### 1 : Accept Existing RUN Command

When there is an existing Run command, the drive starts to operate the application when the power is switched ON.

**WARNING! Sudden Movement Hazard.**

When using a 3-Wire sequence:

- Set the drive for 3-Wire sequence.
- Set b1-17 = 0 [Run Command at Power Up = Disregard Existing RUN Command]
- Wire the drive for 3-Wire sequence.

If these three conditions are correct, the motor can rotate in reverse when energizing the drive:

- The drive is wired for 3-Wire sequence.
- The drive is set for a 2-Wire sequence (default).
- b1-17 = 1 [Accept Existing RUN Command]

Failure to obey can cause death or serious injury from moving equipment.

## ■ b1-21: CLV Start Selection

No. (Hex.)	Name	Description	Default (Range)
b1-21 (0748) Expert	CLV Start Selection	<div style="display: flex; justify-content: space-between; font-size: small;"> <span>V/f</span> <span>CL-V/f</span> <span>OLV</span> <span>CLV</span> <span>AOLV</span> <span>OLV/PM</span> <span>AOLV/PM</span> <span>CLV/PM</span> <span>EZOLV</span> </div> <p>Sets drive response to a Run command when <math>A1-02 = 3</math> or <math>7</math> [Control Method Selection = Closed Loop Vector or PM Closed Loop Vector]. Usually it is not necessary to change this setting.</p>	0 (0, 1)

### 0 : Reject RUN if $b2-01 < U1-05 < E1-09$

When motor speed  $\geq b2-01$  or motor speed  $< E1-09$ , the drive will not accept a Run command.

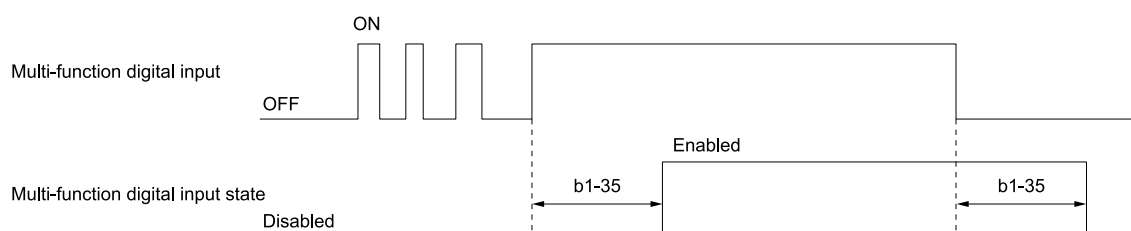
### 1 : Accept RUN Command at Any Speed

When motor speed  $\geq b2-01$  or motor speed  $< E1-09$ , the drive will accept a Run command.

## ■ b1-35: Digital Input Deadband Time

No. (Hex.)	Name	Description	Default (Range)
b1-35 (1117) Expert	Digital Input Deadband Time	<div style="display: flex; justify-content: space-between; font-size: small;"> <span>V/f</span> <span>CL-V/f</span> <span>OLV</span> <span>CLV</span> <span>AOLV</span> <span>OLV/PM</span> <span>AOLV/PM</span> <span>CLV/PM</span> <span>EZOLV</span> </div> <p>Sets the deadband time for MFDIs.</p>	0.0 ms (0.0 to 100.0 ms)

When the on/off time for MFDIs is longer than the time set in b1-35, the drive activates the MFDI. Set this parameter to prevent malfunctions caused by relay chattering for applications in which relays send input to MFDI terminals.



## ◆ b2: DC Injection Braking and Short Circuit Braking

b2 parameters set the DC Injection Braking and Short Circuit Braking functions.

- DC Injection Braking: A braking method that injects DC current into the motor windings. This function should not be used too frequently, because it generates a fair amount of heat in the motor.
- Short Circuit Braking: A braking method for PM motors.

### ■ b2-01: DC Injection/Zero SpeedThreshold

No. (Hex.)	Name	Description	Default (Range)
b2-01 (0189)	DC Injection/Zero SpeedThreshold	<span>V/f</span> <span>CL-V/f</span> <span>OLV</span> <span>CLV</span> <span>AOLV</span> <span>OLV/PM</span> <span>AOLV/PM</span> <span>CLV/PM</span> <span>EZOLV</span> Sets the frequency to start DC Injection Braking, Short Circuit Braking, and Zero Servo.	Determined by A1-02 (0.0 - 10.0 Hz)

**Note:**

This parameter is available when  $b1-03 = 0$  [Stopping Method Selection = Ramp to Stop].

When the control method selected in A1-02 [Control Method Selection] changes, the b2-01 function changes.

- A1-02 = 0, 1, 2, or 4 [V/f, CL-V/f, OLV, or AOLV] and n4-72 = 0 [Speed Feedback Mode = Without Encoder]  
 In these control methods, b2-01 sets the starting frequency for DC Injection Braking at Stop. When the output frequency is less than or equal to the value set in b2-01, the drive will inject the quantity of DC current set in b2-02 [DC Injection Braking Current] into the motor for the time set in b2-04 [DC Inject Braking Time at Stop].

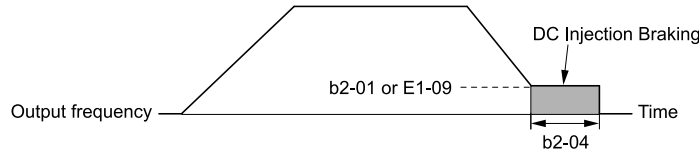


Figure 11.25 DC Injection Braking at Stop

**Note:**

When  $b2-01 \leq E1-09$  [Minimum Output Frequency], the drive will start DC Injection Braking from the frequency set in E1-09.

- A1-02 = 5, 6, or 8 [OLV/PM, AOLV/PM, or EZOLV]  
 In these control methods, b2-01 sets the starting frequency for Short Circuit Braking at Stop. When the output frequency is less than or equal to the value set in b2-01, the drive will do Short Circuit Braking for the time set in b2-13 [Short Circuit Brake Time @ Stop]. When  $b2-04 > 0.00\text{ s}$ , the drive will complete Short Circuit Braking, then do DC Injection Braking for the time set in b2-04.

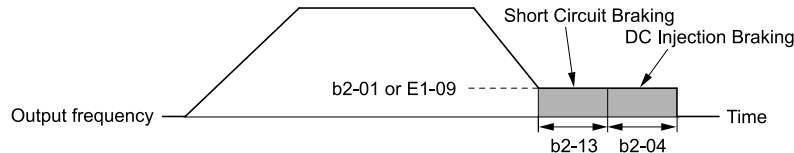


Figure 11.26 Short Circuit Braking at Stop

**Note:**

When  $b2-01 \leq E1-09$  [Minimum Output Frequency], the drive will start Short Circuit Braking from the frequency set in E1-09. If  $b2-01$  and  $E1-09 = 0\text{ Hz}$ , the drive will not do Short Circuit Braking.

- A1-02 = 3 or 7 [CLV or CLV/PM] or A1-02 = 4 [AOLV] and n4-72 = 1 [With Encoder]  
 In these control methods, b2-01 sets the starting frequency for Zero Speed Control at Stop. When the output frequency is less than or equal to the value set in b2-01, the drive will do Zero Speed Control for the time set in b2-04.

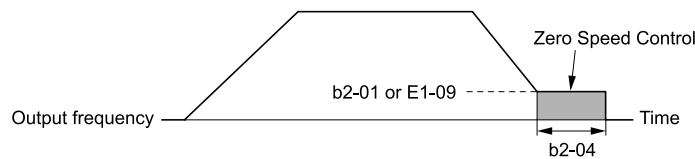


Figure 11.27 Zero Speed Control at Stop

**Note:**

When  $b2-01 \leq E1-09$  [Minimum Output Frequency], the drive will start Short Circuit Braking from the frequency set in E1-09.

## ■ b2-02: DC Injection Braking Current

No. (Hex.)	Name	Description	Default (Range)
b2-02 (018A)	DC Injection Braking Current	<b>V/f</b> <b>CL-V/f</b> <b>OLV</b> <b>CLV</b> <b>AOLV</b> <b>OLV/PM</b> <b>AOLV/PM</b> <b>CLV/PM</b> <b>EZOLV</b> Sets the DC Injection Braking current as a percentage of the drive rated current.	50% (0 - 100%)

When the DC Injection Braking current is more than 50%, the drive decreases the carrier frequency to 1 kHz. The motor rated current determines how much DC Injection Braking current that the drive can use.

The DC Injection Braking current level has an effect on the strength of the magnetic field that locks the motor shaft. As the current level increases, the motor windings will supply more heat. Do not set this parameter higher than the level that is necessary to hold the motor shaft.

### Note:

When  $A1-02 = 4$  [Control Method Selection = AOLV] and  $n4-72 = 1$  [Speed Feedback Mode = With Encoder], the drive ignores the b2-02 setting and does initial excitation.

## ■ b2-03: DC Inject Braking Time at Start

No. (Hex.)	Name	Description	Default (Range)
b2-03 (018B)	DC Inject Braking Time at Start	<b>V/f</b> <b>CL-V/f</b> <b>OLV</b> <b>CLV</b> <b>AOLV</b> <b>OLV/PM</b> <b>AOLV/PM</b> <b>CLV/PM</b> <b>EZOLV</b> Sets the DC Injection Braking Time at stop. Sets the zero speed control at stop in CLV, AOLV, or CLV/PM.	A1-02 = 4: 0.03 s Other than A1-02 = 4: 0.00 s (0.00 - 10.00 s)

This function stops then restarts a coasting motor and increases motor flux to make high starting torque (a process called initial excitation). Set this parameter to 0.00 to disable the function.

### Note:

To restart a coasting motor, use DC Injection Braking to stop and then restart the motor, or enable Speed Search. DC Injection Braking can trigger *ov* [Overvoltage] or *oC* [Overcurrent].

## ■ b2-04: DC Inject Braking Time at Stop

No. (Hex.)	Name	Description	Default (Range)
b2-04 (018C)	DC Inject Braking Time at Stop	<b>V/f</b> <b>CL-V/f</b> <b>OLV</b> <b>CLV</b> <b>AOLV</b> <b>OLV/PM</b> <b>AOLV/PM</b> <b>CLV/PM</b> <b>EZOLV</b> Sets the DC Injection Braking Time at stop. Sets the zero speed control at stop in CLV, AOLV, or CLV/PM.	Determined by A1-02 (0.00 - 10.00 s)

This function fully stops a motor with a large inertia during deceleration and will not let the inertia continue to rotate the motor.

Set this parameter to 0.00 to disable the function.

When a longer time is required to stop the motor, increase the value.

## ■ b2-08: Magnetic Flux Compensation Value

No. (Hex.)	Name	Description	Default (Range)
b2-08 (0190)	Magnetic Flux Compensation Value	<b>V/f</b> <b>CL-V/f</b> <b>OLV</b> <b>CLV</b> <b>AOLV</b> <b>OLV/PM</b> <b>AOLV/PM</b> <b>CLV/PM</b> <b>EZOLV</b> Sets how much current the drive injects when DC Injection Braking at Start starts (Initial Excitation) as a percentage of E2-03 [Motor No-Load Current].	0% (0 - 1000%)

This parameter starts a high-capacity motor (motors with a large secondary circuit time constant). This function can quickly increase motor flux to make high starting torque (a process called initial excitation).

The DC Injection Braking at start current level changes linearly from the value set in b2-08 to the value set in E2-03, as shown in Figure 11.28.

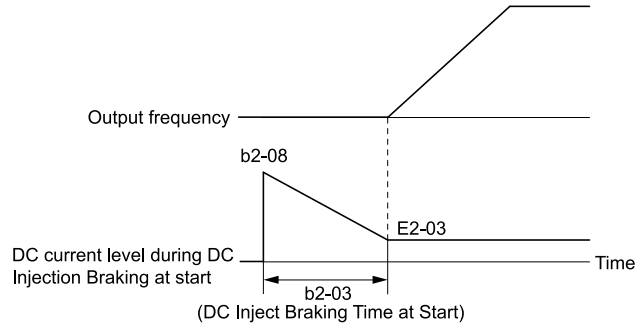


Figure 11.28 DC Current Level during DC Injection Braking at Start

**Note:**

- If  $b2-08 < 100\%$ , flux will develop very slowly.
- When  $b2-08 = 0\%$  the DC current level will be the DC Injection current set in  $b2-02$  [DC Injection Braking Current].
- If  $b2-08$  is set too high, DC Injection Braking at start will make a loud audible noise. Adjust  $b2-08$  to decrease the volume to the permitted level.

■ **b2-12: Short Circuit Brake Time @ Start**

No. (Hex.)	Name	Description	Default (Range)
b2-12 (01BA)	Short Circuit Brake Time @ Start	V/f CL-V/f OLV CLV AOLV <b>OLV/PM</b> AOLV/PM CLV/PM <b>EZOLV</b> Sets the Short Circuit Braking time at start.	0.00 s (0.00 - 25.50 s)

This function restarts a stopped PM motor. The drive short circuits all three motor phases to make braking torque in the motor.

Set this parameter to 0.00 to disable the function.

**Note:**

- Short circuit Braking will let external forces rotate the PM motor. Use DC Injection Braking to prevent motor rotation from external forces.
- Motor speed and load conditions can make it necessary to install a dynamic braking option on the drive.

■ **b2-13: Short Circuit Brake Time @ Stop**

No. (Hex.)	Name	Description	Default (Range)
b2-13 (01BB)	Short Circuit Brake Time @ Stop	V/f CL-V/f OLV CLV AOLV <b>OLV/PM</b> AOLV/PM CLV/PM <b>EZOLV</b> Sets the Short Circuit Braking time at stop.	A1-02 = 8: 0.00 s Other than A1-02 = 8: 0.50 s (0.00 - 25.50 s)

This function fully stops a PM motor with a large inertia during deceleration and will not let the inertia continue to rotate the motor.

Short Circuit Braking operates for the time set in  $b2-13$  when output frequency is less than the value set in  $b2-01$  [DC Injection/Zero SpeedThreshold] or  $E1-09$  [Minimum Output Frequency].

Set this parameter to 0.00 to disable the function.

**Note:**

Motor speed and load conditions can make it necessary to install a dynamic braking option on the drive.

■ **b2-18: Short Circuit Braking Current**

No. (Hex.)	Name	Description	Default (Range)
b2-18 (0177)	Short Circuit Braking Current	V/f CL-V/f OLV CLV AOLV <b>OLV/PM</b> AOLV/PM CLV/PM <b>EZOLV</b> Sets the Short Circuit Braking Current as a percentage of the motor rated current.	100.0% (0.0 - 200.0%)

The Short Circuit Braking current cannot be higher than the drive rated current, although a higher current level can be set using  $b2-18$ . The maximum rated current is 120% when the drive is set for Normal Duty ( $C6-01 = 1$  [Normal Duty Rating]). The maximum rated current is 150% when the drive is set for Heavy Duty ( $C6-01 = 0$  [Heavy Duty Rating]).



## ◆ b3: Speed Search

The Speed Search function detects the actual speed of a coasting motor, then restarts the motor before the motor stops. Use Speed Search in these conditions:

- To continue operation after momentary power loss
- To switch from commercial power supply to drive power
- To restart a coasting fan

For example, the drive output turns off and the motor coasts when there is a momentary loss of power. After you return power, the drive does Speed Search on the coasting motor, and restarts the motor from the detected speed.

When you use a PM motor, enable *b3-01 [Speed Search at Start Selection]*.

There are two types of Speed Search for induction motors: Current Detection and Speed Estimation. Use parameter *b3-24 [Speed Search Method Selection]* to select the type of Speed Search.

Parameter settings are different for different types of Speed Search. Refer to [Table 11.26](#) for more information.

**Table 11.26 Speed Search and Related Parameters**

Parameter	Current Detection 2	Speed Estimation
b3-01 [Speed Search at Start Selection]	x	x
b3-03 [Speed Search Deceleration Time]	x	-
b3-05 [Speed Search Delay Time]	x	x
b3-06 [Speed Estimation Current Level 1]	-	x
b3-07 [Speed Estimation Current Level 2]	-	x
b3-08 [Speed Estimation ACR P Gain]	-	x
b3-09 [Speed Estimation ACR I Time]	-	x
b3-10 [Speed Estimation Detection Gain]	-	x
b3-14 [Bi-directional Speed Search]	-	x
b3-17 [Speed Est Retry Current Level]	x	x
b3-18 [Speed Est Retry Detection Time]	x	x
b3-19 [Speed Search Restart Attempts]	x	x
b3-24 [Speed Search Method Selection]	x (2)	x (1)
b3-25 [Speed Search Wait Time]	x	x
b3-26 [Direction Determination Level]	-	x
b3-27 [Speed Search RUN/BB Priority]	x	x
b3-29 [Speed Search Back-EMF Threshold]	-	-
b3-31 [Spd Search Current Reference Lvl]	x	-
b3-32 [Spd Search Current Complete Lvl]	x	-
b3-33 [Speed Search during Uv Selection]	x	x
b3-35 [Low Back EMF Detection Level]	x	x
b3-36 [High Back EMF Detection Level]	x	x
b3-54 [Search Time]	-	-
b3-55 [Current Increment Time]	-	-

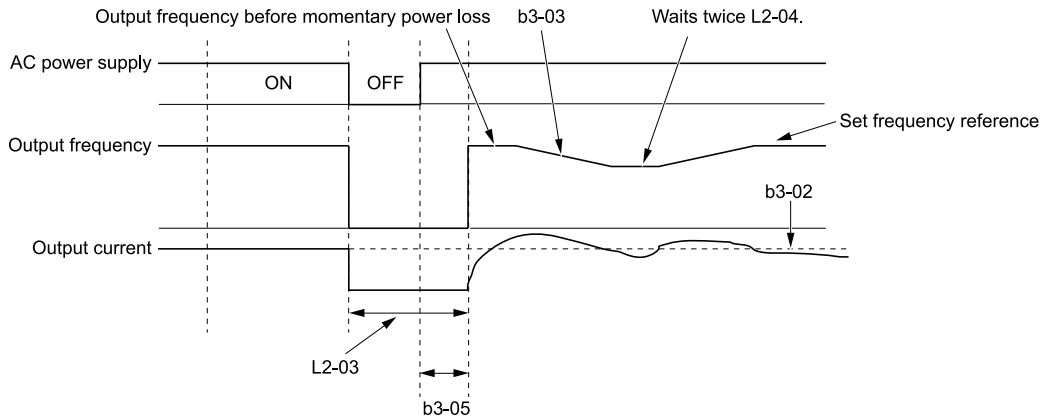
### Note:

- To use Speed Estimation Speed Search with V/f Control, do Rotational Auto-Tuning before you set the Speed Search function. If the wire length between the drive and motor changed since the last time you did Auto-Tuning, do Stationary Auto-Tuning for Line-to-Line Resistance process again.
- If *A1-02 = 5, 6 [PM Open Loop Vector; PM Advanced Open Loop Vector]* and the wiring distance between the motor and drive is long or if the motor is coasting at more than or equal to 200 Hz, do not use Speed Search to restart the motor. Use Short Circuit Braking.

## ■ Current Detection 2

Use this Speed Search function with induction motors. Set *b3-24 = 2 [Speed Search Method Selection = Current Detection 2]*. Current Detection Speed Search injects current into the motor to detect the speed of an induction

motor. Speed Search increases the output voltage for the time set in L2-04 [Powerloss V/f Recovery Ramp Time], starting from the maximum output frequency or the frequency reference.

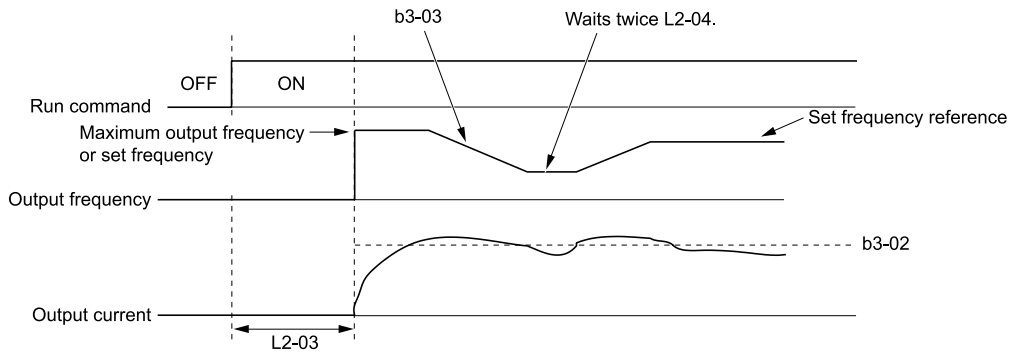


**Figure 11.29 Current Detection Speed Search after Momentary Power Loss**

**Note:**

After you return power, the drive will not do Speed Search until the time set in b3-05 [Speed Search Delay Time] is expired. Thus, the drive will not always start Speed Search although the time set in L2-03 [Minimum Baseblock Time] is expired.

If you enter the Run command at the same time as Speed Search, the drive will not do Speed Search until the time set in L2-03 is expired. If the value set in L2-03 < b3-05, the drive will use the wait time set in b3-05.



**Figure 11.30 Speed Search Selection at Start (Current Detection Type)**

**WARNING! Sudden Movement Hazard.** If you do Current Detection Speed Search with light loads or a stopped motor, the motor can suddenly accelerate and cause serious injury or death.

**Note:**

- You cannot use Current Detection Speed Search with PM motors.
- If the motor is rotating in reverse, you cannot do Speed Search.
- If the drive detects oL1 [Motor Overload] during Current Detection Speed Search, decrease the value set in b3-03.
- If the drive detects oC [Overcurrent] or ov [Overvoltage] during Current Detection Speed Search after the drive recovers from a momentary power loss, increase the value set in L2-03.

**■ Speed Estimation**

Use this Speed Search function with induction motors. Set b3-24 = 1 [Speed Search Method Selection = Speed Estimation]. This function uses less current and has a shorter search time than other functions. This function lets you do Speed Search when the motor is rotating in reverse. When you return power after a power loss, the motor will not suddenly accelerate.

**Note:**

You cannot do Speed Estimation Speed Search in these conditions:

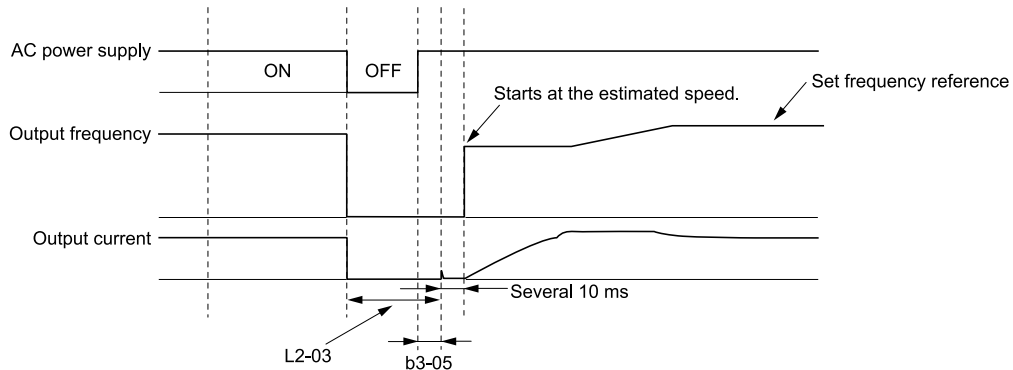
- When you operate more than one motor with one drive
- When you use a high-speed motor (200 Hz or higher)
- When you use a 1.5 kW or smaller motor.
- When the motor output is more than 1 frame size smaller than the drive capacity
- When there is a long wiring distance between the drive and motor

For these conditions, use Current Detection Speed Search.

Speed Estimation Speed Search uses these two steps to estimate the motor speed:

1. Residual Voltage Search

When there is a short baseblock time, the drive searches for residual voltage. The drive uses the residual voltage in the motor to estimate the motor speed and direction of rotation. The drive outputs the estimated motor speed as frequency, then uses the deceleration rate set in *L2-04* to increase the voltage. When the output voltage aligns with the V/f pattern, the drive accelerates or decelerates the motor to the frequency reference. If the drive cannot estimate the motor speed because of low residual voltage, it will automatically do Current Injection.



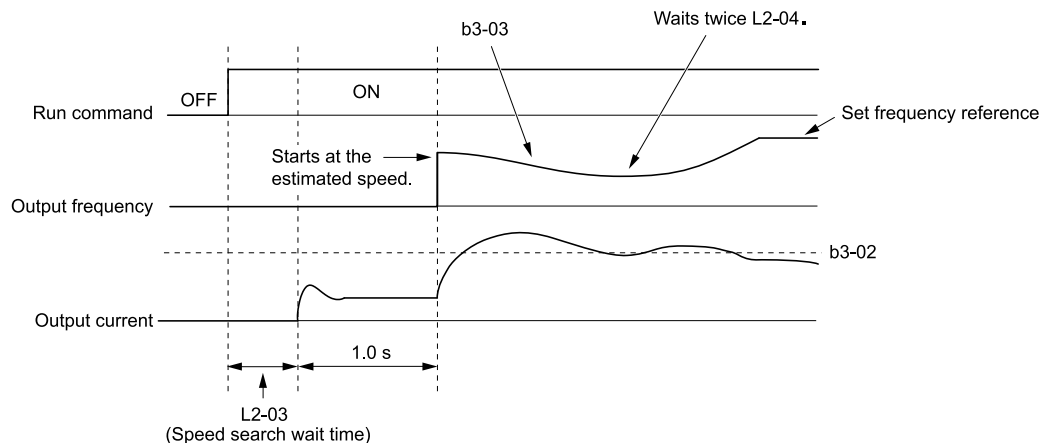
**Figure 11.31 Speed Search after Baseblock**

**Note:**

After you return power, the drive waits for the time set in *b3-05*. If power loss is longer than the time set in *L2-03*, the drive will start Speed Search when the time set in *b3-05* is expired after the power recovery.

**2. Current Injection**

If there is not sufficient residual voltage in the motor, the drive does Current Injection. The drive injects the quantity of DC current set in *b3-06* [Speed Estimation Current Level 1] into the motor windings to estimate the motor speed and direction of rotation. The drive outputs the estimated motor speed as frequency, then uses the deceleration rate set in *L2-04* to increase the voltage. When the output voltage aligns with the V/f pattern, the drive accelerates or decelerates the motor to the frequency reference.



**Figure 11.32 Speed Search Selection at Start**

**Note:**

Set the lower limit of the delay time to *b3-05* for when Speed Search starts.

**■ Speed Search and Operation Conditions**

These conditions apply to Speed Search operation. When *A1-02* = 0, 1, 2 [Control Method Selection = V/f Control, V/f Control with Encoder, Open Loop Vector], set *b3-24* [Speed Search Method Selection] before you do Speed Search.

- Do Speed Search with each Run Command  
The drive ignores a Speed Search command from the external terminals.
- Use an MFDI to do an External Speed Search Command  
To use an MFDI to do Speed Search, input the Run command at the same time that terminal Sx set for Speed Search activates, or after Speed Search activates.  
Set Speed Search to *H1-xx* to do the function externally. You cannot set external Speed Search 1 and 2 at the same time.

**Table 11.27 Execute Speed Search via the Digital Input Terminals**

H1-xx Setting	Name	Current Detection 2	Speed Estimation
61	Speed Search from Fmax	ON: Speed Search starts from <i>E1-04 [Maximum Output Frequency]</i> .	External Speed Search commands 1 and 2 work the same.
62	Speed Search from Fref	ON: Speed Search starts from the frequency reference immediately before you input the Speed Search command.	The drive estimates the motor speed, then starts Speed Search from the estimated speed.

- Do Speed Search with Each Auto Restart  
Set *L5-01 [Number of Auto-Restart Attempts]* = 1 or more. After there is an Auto Restart fault, the drive automatically does Speed Search.
- Do Speed Search after Momentary Power Loss  
Set *L2-01 = 1, 2 [Power Loss Ride Through Select = Enabled for L2-02 Time, Enabled while CPU Power Active]*.
- Do Speed Search after You Clear the External Baseblock Command  
After you clear the external baseblock command, enable the Run command, and when the output frequency is higher than the minimum frequency, the drive does Speed Search.

■ **b3-01: Speed Search at Start Selection**

No. (Hex.)	Name	Description	Default (Range)
b3-01 (0191)	Speed Search at Start Selection	<input checked="" type="checkbox"/> V/f <input checked="" type="checkbox"/> CL-V/f <input checked="" type="checkbox"/> OLV <input type="checkbox"/> CLV <input type="checkbox"/> AOLV <input type="checkbox"/> OLV/PM <input type="checkbox"/> AOLV/PM <input type="checkbox"/> CLV/PM <input type="checkbox"/> EZOLV Sets the Speed Search at Start function where the drive will perform Speed Search with each Run command.	Determined by A1-02 (0, 1)

**0 : Disabled**

Enter a Run command to start to operate the drive at the minimum output frequency.

When the Run command is enabled and the *Speed Search from Fmax or Fref [H1-xx = 61, 62]* is input from a multi-function input terminal, the drive will do Speed Search and start to operate the motor.

**1 : Enabled**

Enter the Run command to do Speed Search. The drive completes Speed Search then starts to operate the motor.

■ **b3-02: SpeedSearch Deactivation Current**

No. (Hex.)	Name	Description	Default (Range)
b3-02 (0192)	SpeedSearch Deactivation Current	<input checked="" type="checkbox"/> V/f <input checked="" type="checkbox"/> CL-V/f <input checked="" type="checkbox"/> OLV <input type="checkbox"/> CLV <input type="checkbox"/> AOLV <input type="checkbox"/> OLV/PM <input type="checkbox"/> AOLV/PM <input type="checkbox"/> CLV/PM <input type="checkbox"/> EZOLV Sets the current level that stops Speed Search as a percentage of the drive rated output current. Usually it is not necessary to change this setting.	Determined by A1-02 (0 - 200%)

If the drive cannot restart the motor, decrease this setting.

■ **b3-03: Speed Search Deceleration Time**

No. (Hex.)	Name	Description	Default (Range)
b3-03 (0193)	Speed Search Deceleration Time	<input checked="" type="checkbox"/> V/f <input checked="" type="checkbox"/> CL-V/f <input checked="" type="checkbox"/> OLV <input type="checkbox"/> CLV <input type="checkbox"/> AOLV <input type="checkbox"/> OLV/PM <input type="checkbox"/> AOLV/PM <input type="checkbox"/> CLV/PM <input type="checkbox"/> EZOLV Sets the deceleration time during Speed Search operation. Set the length of time to decelerate from the maximum output frequency to the minimum output frequency.	2.0 s (0.1 - 10.0 s)

This is the output frequency deceleration time used by Current Detection Speed Search and by the Current Injection Method of Speed Estimation Speed Search.

**Note:**

If the drive detects *oL1 [Motor Overload]* during Current Detection Speed Search, decrease the value set in *b3-03*.

### ■ b3-04: V/f Gain during Speed Search

No. (Hex.)	Name	Description	Default (Range)
b3-04 (0194)	V/f Gain during Speed Search	<b>V/f</b> <b>CL-V/f</b> <b>OLV</b> <b>CLV</b> <b>AOLV</b> <b>OLV/PM</b> <b>AOLV/PM</b> <b>CLV/PM</b> <b>EZOLV</b> Sets the ratio used to reduce the V/f during searches to reduce the output current during speed searches.	Determined by o2-04 (10 - 100)

Use the this formula to calculate the output voltage during Speed Search:

Output voltage during Speed Search = Configured V/f × b3-04

When the current detection search operates correctly, this configuration is not necessary.

### ■ b3-05: Speed Search Delay Time

No. (Hex.)	Name	Description	Default (Range)
b3-05 (0195)	Speed Search Delay Time	<b>V/f</b> <b>CL-V/f</b> <b>OLV</b> <b>CLV</b> <b>AOLV</b> <b>OLV/PM</b> <b>AOLV/PM</b> <b>CLV/PM</b> <b>EZOLV</b> Sets the Speed Search delay time to activate a magnetic contactor installed between the drive and motor.	0.2 s (0.0 - 100.0 s)

When you use a magnetic contactor between the drive and motor, you must close the contactor before the drive will do Speed Search. This parameter sets a delay time to activate the magnetic contactor.

### ■ b3-06: Speed Estimation Current Level 1

No. (Hex.)	Name	Description	Default (Range)
b3-06 (0196) Expert	Speed Estimation Current Level 1	<b>V/f</b> <b>CL-V/f</b> <b>OLV</b> <b>CLV</b> <b>AOLV</b> <b>OLV/PM</b> <b>AOLV/PM</b> <b>CLV/PM</b> <b>EZOLV</b> Sets the level of current that flows to the motor during Speed Estimation Speed Search as a coefficient of the motor rated current. Usually it is not necessary to change this setting.	Determined by o2-04 (0.0 - 2.0)

When the speed estimation value is the minimum output frequency, increase this setting. You can do this when the motor coasts at a high speed while the drive estimates the speed during Speed Estimation Speed Search. The limit of the output current during speed search is automatically the drive rated current.

**Note:**

When the drive cannot accurately estimate the speed after you adjust this parameter, use Current Detection Speed Search.

### ■ b3-07: Speed Estimation Current Level 2

No. (Hex.)	Name	Description	Default (Range)
b3-07 (0197) Expert	Speed Estimation Current Level 2	<b>V/f</b> <b>CL-V/f</b> <b>OLV</b> <b>CLV</b> <b>AOLV</b> <b>OLV/PM</b> <b>AOLV/PM</b> <b>CLV/PM</b> <b>EZOLV</b> Sets the level of current that flows to the motor during Speed Estimation Speed Search as a coefficient of E2-03 [Motor No-Load Current] or E4-03 [Motor 2 Rated No-Load Current]. Usually it is not necessary to change this setting.	1.0 (0.0 - 3.0)

During Speed Estimation Speed Searches, when the speed estimation value aligns with the minimum output frequency, increase the setting value in 0.1-unit increments. The limit of the output current during speed search is automatically the drive rated current.

### ■ b3-08: Speed Estimation ACR P Gain

No. (Hex.)	Name	Description	Default (Range)
b3-08 (0198) Expert	Speed Estimation ACR P Gain	<b>V/f</b> <b>CL-V/f</b> <b>OLV</b> <b>CLV</b> <b>AOLV</b> <b>OLV/PM</b> <b>AOLV/PM</b> <b>CLV/PM</b> <b>EZOLV</b> Sets the proportional gain for the automatic current regulator during Speed Estimation Speed Search. Also adjusts speed search responsiveness. Usually it is not necessary to change this setting.	A1-02 = 0 through 4: Determined by o2-04 , A1-02 = 5, 6, or 8: Determined by A1-02 (0.00 - 6.00)

■ **b3-09: Speed Estimation ACR I Time**

No. (Hex.)	Name	Description	Default (Range)
b3-09 (0199) Expert	Speed Estimation ACR I Time	<input type="checkbox"/> V/f <input type="checkbox"/> CL-V/f <input type="checkbox"/> OLV <input type="checkbox"/> CLV <input type="checkbox"/> AOLV <input type="checkbox"/> OLV/PM <input type="checkbox"/> AOLV/PM <input type="checkbox"/> CLV/PM <input type="checkbox"/> EZOLV Sets the integral time for the automatic current regulator during Speed Estimation Speed Search. Also adjusts speed search responsiveness. Usually it is not necessary to change this setting.	Determined by A1-02 (0.0 - 1000.0 ms)

■ **b3-10: Speed Estimation Detection Gain**

No. (Hex.)	Name	Description	Default (Range)
b3-10 (019A) Expert	Speed Estimation Detection Gain	<input type="checkbox"/> V/f <input type="checkbox"/> CL-V/f <input type="checkbox"/> OLV <input type="checkbox"/> CLV <input type="checkbox"/> AOLV <input type="checkbox"/> OLV/PM <input type="checkbox"/> AOLV/PM <input type="checkbox"/> CLV/PM <input type="checkbox"/> EZOLV Sets the gain to correct estimated frequencies from Speed Estimation Speed Search.	1.05 (1.00 - 1.20)

If the drive detects *ov* [DC Bus Overvoltage] when you restart the motor, increase the setting value.

■ **b3-14: Bi-directional Speed Search**

No. (Hex.)	Name	Description	Default (Range)
b3-14 (019E)	Bi-directional Speed Search	<input type="checkbox"/> V/f <input type="checkbox"/> CL-V/f <input type="checkbox"/> OLV <input type="checkbox"/> CLV <input type="checkbox"/> AOLV <input type="checkbox"/> OLV/PM <input type="checkbox"/> AOLV/PM <input type="checkbox"/> CLV/PM <input type="checkbox"/> EZOLV Sets the direction of Speed Search to the direction of the frequency reference or in the motor rotation direction as detected by the drive.	Determined by A1-02 (0, 1)

**0 : Disabled**

The drive uses the frequency reference to detect the direction of motor rotation.

**1 : Enabled**

The drive detects the direction of motor rotation during Speed Search.

■ **b3-17: Speed Est Retry Current Level**

No. (Hex.)	Name	Description	Default (Range)
b3-17 (01F0) Expert	Speed Est Retry Current Level	<input type="checkbox"/> V/f <input type="checkbox"/> CL-V/f <input type="checkbox"/> OLV <input type="checkbox"/> CLV <input type="checkbox"/> AOLV <input type="checkbox"/> OLV/PM <input type="checkbox"/> AOLV/PM <input type="checkbox"/> CLV/PM <input type="checkbox"/> EZOLV Sets the current level for the search retry function in Speed Estimation Speed Search as a percentage where drive rated current is a setting value of 100%.	150% (0 - 200%)

When a large quantity of current flows during Speed Estimation Speed Search, the drive temporarily stops operation to prevent overvoltage and overcurrent. When the current is at the level set in *b3-17*, the drive tries speed search again.

■ **b3-18: Speed Est Retry Detection Time**

No. (Hex.)	Name	Description	Default (Range)
b3-18 (01F1) Expert	Speed Est Retry Detection Time	<input type="checkbox"/> V/f <input type="checkbox"/> CL-V/f <input type="checkbox"/> OLV <input type="checkbox"/> CLV <input type="checkbox"/> AOLV <input type="checkbox"/> OLV/PM <input type="checkbox"/> AOLV/PM <input type="checkbox"/> CLV/PM <input type="checkbox"/> EZOLV Sets the length of time that the drive will wait to retry Speed Estimation Speed Search when too much current flow stopped the Speed Search.	0.10 s (0.00 - 1.00 s)

When the current is more than the level set in *b3-17* [Speed Est Retry Current Level] during the time set in *b3-18*, the drive tries speed search again.

■ **b3-19: Speed Search Restart Attempts**

No. (Hex.)	Name	Description	Default (Range)
b3-19 (01F2)	Speed Search Restart Attempts	<input type="checkbox"/> V/f <input type="checkbox"/> CL-V/f <input type="checkbox"/> OLV <input type="checkbox"/> CLV <input type="checkbox"/> AOLV <input type="checkbox"/> OLV/PM <input type="checkbox"/> AOLV/PM <input type="checkbox"/> CLV/PM <input type="checkbox"/> EZOLV Sets the number of times to restart Speed Search if Speed Search does not complete.	3 times (0 - 10 times)

If the drive does the number of Speed Search restarts set in this parameter, it will trigger an *SEr* [Speed Search Retries Exceeded] error.

### ■ b3-24: Speed Search Method Selection

No. (Hex.)	Name	Description	Default (Range)
b3-24 (01C0)	Speed Search Method Selection	<input checked="" type="checkbox"/> V/f <input type="checkbox"/> CL-V/f <input type="checkbox"/> OLV <input type="checkbox"/> CLV <input type="checkbox"/> AOLV <input type="checkbox"/> OLV/PM <input type="checkbox"/> AOLV/PM <input type="checkbox"/> CLV/PM <input type="checkbox"/> EZOLV Sets the Speed Search method when starting the motor or when restoring power after a momentary power loss.	2 (1, 2)

Set *b3-01* = 1 [Speed Search at Start Selection = Enabled] to do Speed Search at start. Set *L2-01* = 1 [Power Loss Ride Through Select = Enabled for L2-02 Time] to do Speed Search after you restore power after a momentary power loss.

#### 1 : Speed Estimation

The drive uses the residual voltage from a short baseblock time to estimate the motor speed.

If there is not sufficient residual voltage, then the drive will inject DC current into the motor to estimate the motor speed.

#### 2 : Current Detection 2

The drive will inject DC current into the motor to estimate motor speed.

### ■ b3-25: Speed Search Wait Time

No. (Hex.)	Name	Description	Default (Range)
b3-25 (01C8) Expert	Speed Search Wait Time	<input checked="" type="checkbox"/> V/f <input type="checkbox"/> CL-V/f <input type="checkbox"/> OLV <input type="checkbox"/> CLV <input type="checkbox"/> AOLV <input type="checkbox"/> OLV/PM <input type="checkbox"/> AOLV/PM <input type="checkbox"/> CLV/PM <input type="checkbox"/> EZOLV Sets the length of time the drive will wait to start the Speed Search Retry function.	0.5 s (0.0 - 30.0 s)

If the drive detects these faults during speed search, increase the setting value:

- *oC* [Overcurrent]
- *ov* [Overvoltage]
- *SEr* [Speed Search Retries Exceeded]

### ■ b3-26: Direction Determination Level

No. (Hex.)	Name	Description	Default (Range)
b3-26 (01C7) Expert	Direction Determination Level	<input checked="" type="checkbox"/> V/f <input type="checkbox"/> CL-V/f <input type="checkbox"/> OLV <input type="checkbox"/> CLV <input type="checkbox"/> AOLV <input type="checkbox"/> OLV/PM <input type="checkbox"/> AOLV/PM <input type="checkbox"/> CLV/PM <input type="checkbox"/> EZOLV Sets the level to find the motor rotation direction. Increase the value if the drive cannot find the direction.	1000 (40 - 60000)

### ■ b3-27: Speed Search RUN/BB Priority

No. (Hex.)	Name	Description	Default (Range)
b3-27 (01C9) Expert	Speed Search RUN/BB Priority	<input checked="" type="checkbox"/> V/f <input type="checkbox"/> CL-V/f <input type="checkbox"/> OLV <input type="checkbox"/> CLV <input type="checkbox"/> AOLV <input type="checkbox"/> OLV/PM <input type="checkbox"/> AOLV/PM <input type="checkbox"/> CLV/PM <input type="checkbox"/> EZOLV Sets the conditions necessary to start Speed Search.	0 (0, 1)

Executes *Speed Search from Fmax or Fref* [*H1-xx* = 61/62] for initial speed searches or from the MFDI terminal.

**0 : SS Only if RUN Applied Before BB**

**1 : SS Regardless of RUN/BB Sequence**

### ■ b3-29: Speed Search Back-EMF Threshold

No. (Hex.)	Name	Description	Default (Range)
b3-29 (077C) Expert	Speed Search Back-EMF Threshold	<div style="display: flex; justify-content: space-between; font-size: 0.8em; margin-bottom: 5px;"> <span>V/f</span> <span>CL-V/f</span> <span>OLV</span> <span>CLV</span> <span>AOLV</span> <span><b>OLV/PM</b></span> <span>AOLV/PM</span> <span>CLV/PM</span> <span>EZOLV</span> </div> Sets the induced voltage for motors that use Speed Search. The drive will start Speed Search when the motor induced voltage level is the same as the setting value. Usually it is not necessary to change this setting.	10% (0 - 10%)

To make adjustments, gradually decrease the setting value. If you decrease the setting value too much, speed search will not operate correctly.

### ■ b3-31: Spd Search Current Reference Lvl

No. (Hex.)	Name	Description	Default (Range)
b3-31 (0BC0) Expert	Spd Search Current Reference Lvl	<div style="display: flex; justify-content: space-between; font-size: 0.8em; margin-bottom: 5px;"> <span>V/f</span> <span>CL-V/f</span> <span><b>OLV</b></span> <span>CLV</span> <span>AOLV</span> <span>OLV/PM</span> <span>AOLV/PM</span> <span>CLV/PM</span> <span>EZOLV</span> </div> Sets the current level that decreases the output current during Current Detection Speed Search.	1.50 (1.50 - 3.50)

Set this parameter as a ratio of  $E2-03$  [Motor No-Load Current]. Sets a current level given that  $E2-03$  is 30% of the motor rated current when  $E2-03 \leq \text{Motor Rated Current} \times 0.3$ .

### ■ b3-32: Spd Search Current Complete Lvl

No. (Hex.)	Name	Description	Default (Range)
b3-32 (0BC1) Expert	Spd Search Current Complete Lvl	<div style="display: flex; justify-content: space-between; font-size: 0.8em; margin-bottom: 5px;"> <span>V/f</span> <span>CL-V/f</span> <span><b>OLV</b></span> <span>CLV</span> <span>AOLV</span> <span>OLV/PM</span> <span>AOLV/PM</span> <span>CLV/PM</span> <span>EZOLV</span> </div> Sets the current level that completes Speed Search.	1.20 (0.00 - 1.49)

The Current Detection Speed Search gradually decreases the output frequency to search for the motor speed when the output current is equal to or less than Speed Search Current Complete Level.

Set this parameter as a ratio of  $E2-03$  [Motor No-Load Current]. Sets a current level given that  $E2-03$  is 30% of the motor rated current when  $E2-03 \leq \text{Motor Rated Current} \times 0.3$ .

### ■ b3-33: Speed Search during Uv Selection

No. (Hex.)	Name	Description	Default (Range)
b3-33 (0B3F) Expert	Speed Search during Uv Selection	<div style="display: flex; justify-content: space-between; font-size: 0.8em; margin-bottom: 5px;"> <span>V/f</span> <span>CL-V/f</span> <span>OLV</span> <span>CLV</span> <span>AOLV</span> <span><b>OLV/PM</b></span> <span>AOLV/PM</span> <span>CLV/PM</span> <span>EZOLV</span> </div> Sets the function that starts Speed Search at start-up if the drive detects a $U_v$ [Undervoltage] when it receives a Run command.	1 (0, 1)

Set these three parameters as shown to enable b3-33:

- $L2-01 = 1, 2$  [Power Loss Ride Through Select = Enabled for L2-02 Time, Enabled while CPU Power Active]
- $b3-01 = 1$  [Speed Search at Start Selection = Enabled]
- $b1-03 = 1$  [Stopping Method Selection = Coast to Stop]

**0** : Disabled

**1** : Enabled

### ■ b3-35: Low Back EMF Detection Level

No. (Hex.)	Name	Description	Default (Range)
b3-35 (0BC3) Expert	Low Back EMF Detection Level	<div style="display: flex; justify-content: space-between; font-size: 0.8em; margin-bottom: 5px;"> <span>V/f</span> <span>CL-V/f</span> <span>OLV</span> <span>CLV</span> <span>AOLV</span> <span><b>OLV/PM</b></span> <span>AOLV/PM</span> <span>CLV/PM</span> <span>EZOLV</span> </div> Sets the level of induced voltage that the drive must detect to start Speed Search.	10% (5 - 50%)

For example, when the induced voltage at 10% of the setting is a minimum of 20 V for 200 V class drives, the drive will do restarts.



### ■ b3-36: High Back EMF Detection Level

No. (Hex.)	Name	Description	Default (Range)
b3-36 (0BC4) Expert	High Back EMF Detection Level	<div style="display: flex; justify-content: space-between; font-size: 0.8em; font-weight: bold; margin-bottom: 5px;"> <span>V/f</span> <span>CL-V/f</span> <span>OLV</span> <span>CLV</span> <span>AOLV</span> <span>OLV/PM</span> <span>AOLV/PM</span> <span>CLV/PM</span> <span>EZOLV</span> </div> Sets one of the factors in the formula to prevent drive restarts and cause the drive to enter standby. The drive will enter standby and will not restart when the detected induced voltage of the motor $\geq$ power supply voltage $\times$ b3-36. Usually it is not necessary to change this setting.	0.970 (0.500 - 1.000)

For example, if the setting value is 0.83% and the voltage does not decrease to the induced voltage at approximately 183 V when the power supply voltage is 220 V, the drive will not do restarts.

### ■ b3-54: Search Time

No. (Hex.)	Name	Description	Default (Range)
b3-54 (3123)	Search Time	<div style="display: flex; justify-content: space-between; font-size: 0.8em; font-weight: bold; margin-bottom: 5px;"> <span>V/f</span> <span>CL-V/f</span> <span>OLV</span> <span>CLV</span> <span>AOLV</span> <span>OLV/PM</span> <span>AOLV/PM</span> <span>CLV/PM</span> <span>EZOLV</span> </div> Sets the length of time that the drive will run Speed Search.	400 ms (10 - 2000 ms)

If you set this parameter too low, Speed Search will not operate correctly.

If the drive detects *oC* [Overcurrent] immediately after Speed Search Starts:

- Increase the value of L2-03 [Minimum Baseblock Time] and decrease the motor speed you use to start Speed Search.
- Increases the setting value of b3-08 [Speed Estimation ACR P Gain].
- Increase the value of b3-54.

If the drive detects *oC* or *ov* [DC Bus Overvoltage] during Speed Search, increase the value of b3-08.

### ■ b3-55: Current Increment Time

No. (Hex.)	Name	Description	Default (Range)
b3-55 (3124) Expert	Current Increment Time	<div style="display: flex; justify-content: space-between; font-size: 0.8em; font-weight: bold; margin-bottom: 5px;"> <span>V/f</span> <span>CL-V/f</span> <span>OLV</span> <span>CLV</span> <span>AOLV</span> <span>OLV/PM</span> <span>AOLV/PM</span> <span>CLV/PM</span> <span>EZOLV</span> </div> Sets the length of time that the drive will increase the current from zero current to the setting value of b3-06 [Speed Estimation Current Level 1].	10 ms (10 - 2000 ms)

Gradually increase the setting value when a large quantity of current flows after speed search starts. If you set this value too high, speed search will not operate correctly.

## ◆ b4: Timer Function

The drive uses timers to delay activating and deactivating MFDO terminals.

Timers prevent sensors and switches from making chattering noise.

There are two types of timers:

- Timers that set a delay for timer inputs and timer outputs.  
These timers delay activating and deactivating of the MFDIs and MFDOs.  
To enable this function, set H1-xx = 18 [MFDI Function Select = Timer Function], and set H2-01 to H2-03 = 12 [MFDO Function Select = Timer Output].
- Timers that set a delay to activate and deactivate MFDO terminals.  
These timers delay activating and deactivating MFDO terminals.  
To enable this function, set delay times in parameters b4-03 to b4-08.

### ■ Timer Function Operation

- Timers that set a delay for timer inputs and timer outputs  
Triggers timer output if the timer input is active for longer than the time set in b4-01 [Timer Function ON-Delay Time]. Triggers timer output late for the time set in b4-02 [Timer Function OFF-Delay Time]. [Figure 11.33](#) shows an example of how the timer function works.

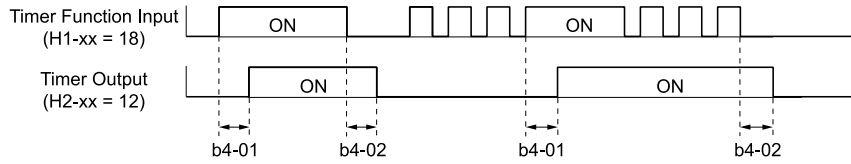


Figure 11.33 Example of Timer Function Operation

- Setting on/off-delay time for MFDO

Figure 11.34 uses H2-01 terminals to show an example of how the timer function works. Use *b4-03* [Terminal M1-M2 ON-Delay Time] and *b4-04* [Terminal M1-M2 OFF-Delay Time] to set this function.

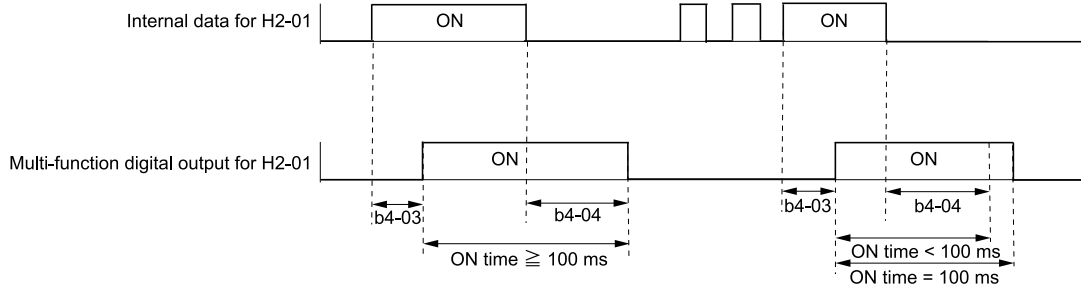


Figure 11.34 Example of How the Timer Function Works with H2-01 Terminals

**Note:**

When the terminal is triggered, it continues for a minimum of 100 ms. The on/off-delay time of MFDO terminal does not have an effect.

■ **b4-01: Timer Function ON-Delay Time**

No. (Hex.)	Name	Description	Default (Range)
b4-01 (01A3)	Timer Function ON-Delay Time	<b>V/f</b> <b>CL-V/f</b> <b>OLV</b> <b>CLV</b> <b>AOLV</b> <b>OLV/PM</b> <b>AOLV/PM</b> <b>CLV/PM</b> <b>EZOLV</b> Sets the ON-delay time for the timer input.	0.0 s (0.0 - 3000.0 s)

■ **b4-02: Timer Function OFF-Delay Time**

No. (Hex.)	Name	Description	Default (Range)
b4-02 (01A4)	Timer Function OFF-Delay Time	<b>V/f</b> <b>CL-V/f</b> <b>OLV</b> <b>CLV</b> <b>AOLV</b> <b>OLV/PM</b> <b>AOLV/PM</b> <b>CLV/PM</b> <b>EZOLV</b> Sets the OFF-delay time for the timer input.	0.0 s (0.0 - 3000.0 s)

■ **b4-03: Terminal M1-M2 ON-Delay Time**

No. (Hex.)	Name	Description	Default (Range)
b4-03 (0B30) Expert	Terminal M1-M2 ON-Delay Time	<b>V/f</b> <b>CL-V/f</b> <b>OLV</b> <b>CLV</b> <b>AOLV</b> <b>OLV/PM</b> <b>AOLV/PM</b> <b>CLV/PM</b> <b>EZOLV</b> Sets the delay time to activate the contact after the function set in H2-01 activates.	0 ms (0 - 65000 ms)

■ **b4-04: Terminal M1-M2 OFF-Delay Time**

No. (Hex.)	Name	Description	Default (Range)
b4-04 (0B31) Expert	Terminal M1-M2 OFF-Delay Time	<b>V/f</b> <b>CL-V/f</b> <b>OLV</b> <b>CLV</b> <b>AOLV</b> <b>OLV/PM</b> <b>AOLV/PM</b> <b>CLV/PM</b> <b>EZOLV</b> Sets the delay time to deactivate the contact after the function set in H2-01 deactivates.	0 ms (0 - 65000 ms)

■ **b4-05: Terminal M3-M4 ON-Delay Time**

No. (Hex.)	Name	Description	Default (Range)
b4-05 (0B32) Expert	Terminal M3-M4 ON-Delay Time	<b>V/f</b> <b>CL-V/f</b> <b>OLV</b> <b>CLV</b> <b>AOLV</b> <b>OLV/PM</b> <b>AOLV/PM</b> <b>CLV/PM</b> <b>EZOLV</b> Sets the delay time to activate the contact after the function set in H2-02 activates.	0 ms (0 - 65000 ms)

### ■ b4-06: Terminal M3-M4 OFF-Delay Time

No. (Hex.)	Name	Description	Default (Range)
b4-06 (0B33) Expert	Terminal M3-M4 OFF-Delay Time	<div style="display: flex; justify-content: space-between; font-size: 0.8em; font-weight: bold; margin-bottom: 5px;"> <span>V/f</span> <span>CL-V/f</span> <span>OLV</span> <span>CLV</span> <span>AOLV</span> <span>OLV/PM</span> <span>AOLV/PM</span> <span>CLV/PM</span> <span>EZOLV</span> </div> Sets the delay time to deactivate the contact after the function set in <i>H2-02</i> deactivates.	0 ms (0 - 65000 ms)

### ■ b4-07: Terminal M5-M6 ON-Delay Time

No. (Hex.)	Name	Description	Default (Range)
b4-07 (0B34) Expert	Terminal M5-M6 ON-Delay Time	<div style="display: flex; justify-content: space-between; font-size: 0.8em; font-weight: bold; margin-bottom: 5px;"> <span>V/f</span> <span>CL-V/f</span> <span>OLV</span> <span>CLV</span> <span>AOLV</span> <span>OLV/PM</span> <span>AOLV/PM</span> <span>CLV/PM</span> <span>EZOLV</span> </div> Sets the delay time to activate the contact after the function set in <i>H2-03</i> activates.	0 ms (0 - 65000 ms)

### ■ b4-08: Terminal M5-M6 OFF-Delay Time

No. (Hex.)	Name	Description	Default (Range)
b4-08 (0B35) Expert	Terminal M5-M6 OFF-Delay Time	<div style="display: flex; justify-content: space-between; font-size: 0.8em; font-weight: bold; margin-bottom: 5px;"> <span>V/f</span> <span>CL-V/f</span> <span>OLV</span> <span>CLV</span> <span>AOLV</span> <span>OLV/PM</span> <span>AOLV/PM</span> <span>CLV/PM</span> <span>EZOLV</span> </div> Sets the delay time to deactivate the contact after the function set in <i>H2-03</i> deactivates.	0 ms (0 - 65000 ms)

## ◆ b5: PID Control

The drive has a PID control function. You can control drive output to adjust the proportional gain, integral time, and derivative time that has an effect on the bias between the target value and the feedback value to match the target value to the detected value. Use this function to adjust the drive output to accurately match the flow, pressure, and temperature in the application match the target value.

Use a combination of these controls to increase the performance:

- P control  
P control has a proportional effect on the deviation. It outputs the product (the controlled output) proportional to the deviation. You cannot use only the offset from P control to get to zero deviation.
- I control  
I control is the integral of the deviation. It uses an integral value of the deviation to output the product (the controlled output). I control helps align the feedback value and the target value.
- D control  
D control is the derivative of the deviation. D control has an effect on drive output when there are sudden, large changes in the output. It quickly returns drive output to the value before the sudden change. It multiplies a time constant by a derivative value of the deviation (slope of the deviation), and adds that result to PID input to calculate the deviation of the signal, then it corrects the deviation.

**Note:**

D control has causes less stable operation because the noise changes the deviation signal. Use D control only when necessary.

### ■ PID Control Operation

Figure 11.35 shows PID control operation. The modified output (output frequency) changes when the drive uses PID control to keep the deviation (the difference between the target value and the feedback value) constant.

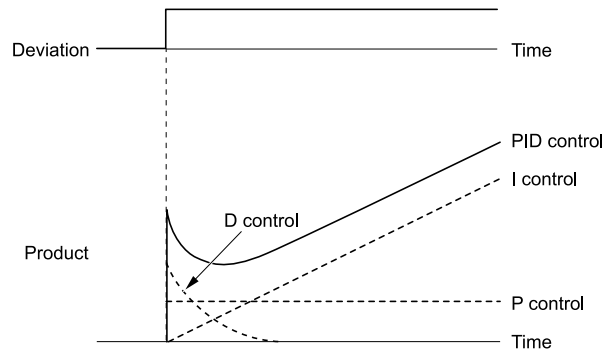


Figure 11.35 PID Control Operation

■ PID Control Applications

Table 11.28 shows applications for PID control.

Table 11.28 PID Control Applications

Application	Description	Sensors Used
Speed control	<ul style="list-style-type: none"> <li>The drive uses a feedback signal for the machine speed, and adjusts that speed to align with the target value.</li> <li>The drive uses speed data from other machinery as the target value to do synchronous control. The drive then adds that target value to the feedback from the machine it is operating to align its speed with the other machinery.</li> </ul>	Tacho generator
Pressure control	The drive uses feedback from the actual pressure to hold constant pressure.	Pressure sensor
Flow control	The drive uses feedback from the actual flow to hold constant flow.	Flow rate sensor
Temperature control	The drive uses feedback from the actual temperature to control a fan and hold constant temperature.	Thermocoupler, thermistor

■ Input Methods for the PID Setpoint

Use *b5-01 [PID Mode Setting]* to select how the PID setpoint is input to the drive.

When *b5-01 = 1 or 2 [PID Mode Setting = Standard or Standard (D on feedback)]*, the frequency reference set in *b1-01 [Frequency Reference Selection 1]* or *b1-15 [Frequency Reference Selection 2]* will be the PID setpoint, or the one of the values shown in Table 11.29 will be the PID setpoint.

When *b5-01 = 3 or 4 [PID Mode Setting = Fref + PID Trim or Fref + PID Trim (D on feedback)]*, one of the inputs in Table 11.29 will be the PID setpoint.

Table 11.29 Input Methods for the PID Setpoint

Input Methods for the PID Setpoint	Setting
Multi-function analog input terminal A1	Set <i>H3-02 = C [Terminal A1 Function Selection = PID Setpoint]</i> .
Multi-function analog input terminal A2	Set <i>H3-10 [Terminal A2 Function Selection] = C</i> .
Multi-function analog input terminal A3	Set <i>H3-06 [Terminal A3 Function Selection] = C</i> .
MEMOBUS/Modbus register 0006H	Sets MEMOBUS/Modbus register 000FH (Control Selection Setting) bit 1 to 1 (PID setpoint input). Enters the PID setpoint to MEMOBUS/Modbus register 0006H (PID Target, 0.01% units, signed).
Pulse train input terminal RP	Set <i>H6-01 = 2 [Terminal RP Pulse Train Function = PID Setpoint Value]</i> .
<i>b5-19 [PID Setpoint Value]</i>	Set <i>b5-18 = 1 [b5-19 PID Setpoint Selection = Enabled]</i> . Enters the PID setpoint to <i>b5-19</i> .

Note:

If you set two inputs for the PID setpoint, it will trigger operation error *oPE07 [Analog Input Selection Error]*.

## ■ Entering the PID Feedback Value

You can use two methods to input the PID feedback value to the drive. One method uses a single feedback signal for usual PID control. The other method uses two signals. The difference between those signals sets the deviation.

- **Use one feedback signal.**

Use [Table 11.30](#) to select how the feedback signal is input to the drive for PID control.

**Table 11.30 PID Feedback Input Method**

PID Feedback Input Method	Setting
Multi-function analog input terminal A1	Set H3-02 = B [PID Feedback].
Multi-function analog input terminal A2	Set H3-10 = B.
Multi-function analog input terminal A3	Set H3-06 = B.
Pulse train input terminal RP	Set H6-01 = 1 [PID Feedback Value].

- **The drive uses two feedback signals, and the difference between those signals becomes the deviation.**

Use [Table 11.31](#) to select how the second feedback signal is input to the drive. The drive calculates the deviation of the second feedback value. Set H3-02, H3-06, or H3-10 = 16 [Terminal A1/A3/A2 Function Selection = Differential PID Feedback] to enable the second feedback signal used to calculate the deviation.

**Table 11.31 PID Differential Feedback Input Method**

PID Differential Feedback Input Method	Setting
Multi-function analog input terminal A1	Set H3-02 = 16 [Differential PID Feedback].
Multi-function analog input terminal A2	Set H3-10 = 16.
Multi-function analog input terminal A3	Set H3-06 = 16.

**Note:**

If you set more than one of H3-02, H3-06, and H3-10 to 16, it will trigger oPE07 [Analog Input Selection Error].

### PID Control Block Diagram

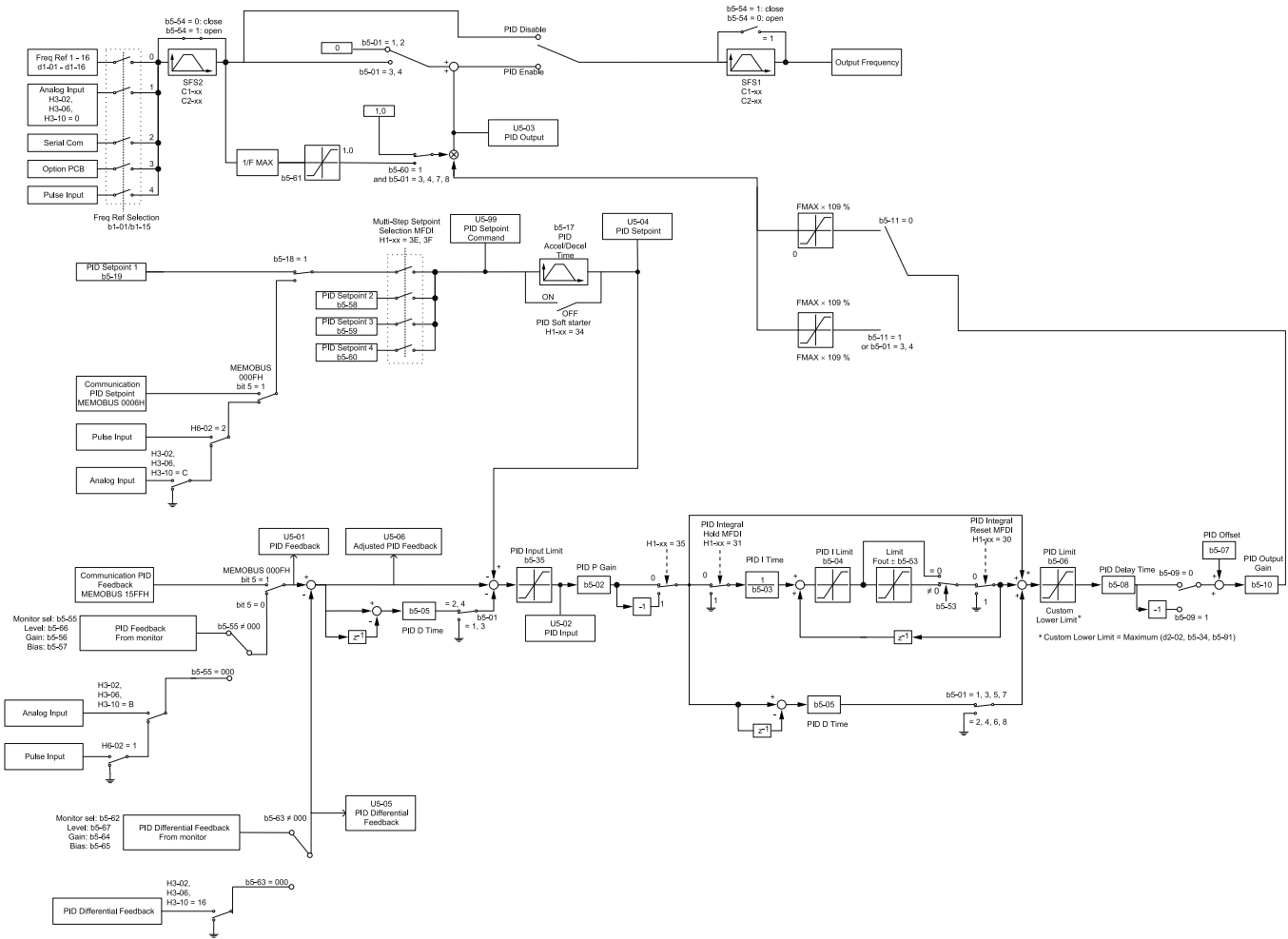


Figure 11.36 PID Control Block Diagram

### PID Feedback Loss Detection

The PID feedback loss detection function detects broken sensors and defective wiring between the drive and sensors.

Use the PID feedback loss detection function when you use PID control. If the feedback signal is too low, the motor can suddenly accelerate to the maximum output frequency. This function prevents such risks to the load.

The drive uses two methods to detect feedback loss:

- **PID Feedback Loss [FbL]**  
 Set these parameters for the PID feedback loss detection function.  
 The drive detects feedback loss when the feedback value is less than the value in *b5-13* for longer than the time in *b5-14*.
  - *b5-12* [Feedback Loss Detection Select]
  - *b5-13* [PID Feedback Loss Detection Lvl]
  - *b5-14* [PID Feedback Loss Detection Time]
- **Excessive PID Feedback [FbH]**  
 Set these parameters to set how the drive detects a feedback level that is too high.  
 The drive detects too much PID feedback when the feedback value is more than the value in *b5-36* for longer than the time in *b5-37*.
  - *b5-12* [Feedback Loss Detection Select]
  - *b5-36* [PID High Feedback Detection Lvl]
  - *b5-37* [PID High Feedback Detection Time]

Figure 11.37 shows the operation principle when the feedback value is too low, and the drive detects feedback loss. The operation is the same when the drive detects too much feedback.

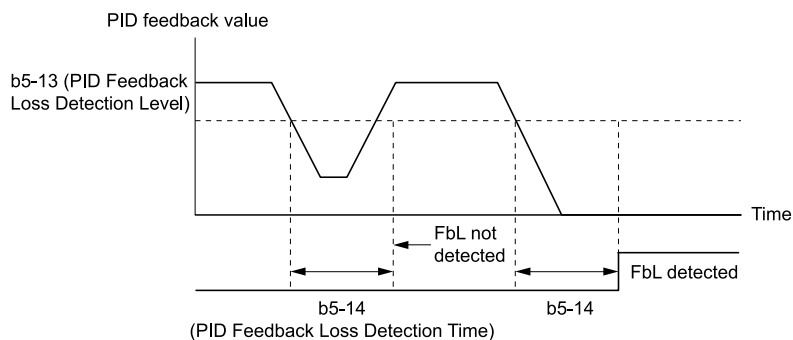


Figure 11.37 Time Chart for PID Feedback Loss Detection Time

## ■ PID Sleep

PID sleep stops drive operation when the PID output or the frequency reference is less than *b5-15* [PID Sleep Function Start Level]. This function shuts off drive output after the motor decelerates to the set frequency.

The drive will automatically restart the motor when the PID output or the frequency reference is more than the *b5-15* value for the time set in *b5-16* [PID Sleep Delay Time].

Figure 11.38 shows the PID Sleep function.

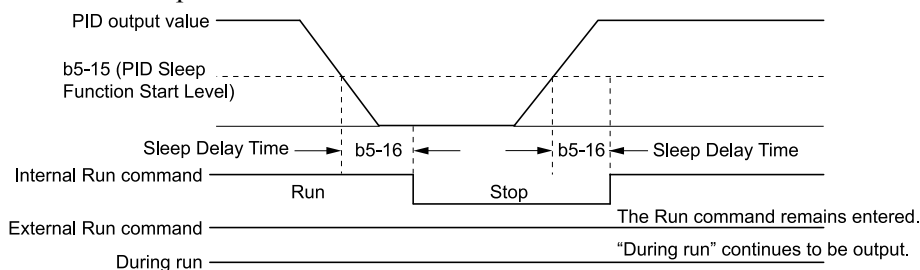


Figure 11.38 PID Sleep Time Chart

### Note:

- The PID Sleep function is enabled when PID control is disabled.
- When the PID Sleep function is triggered, the drive will stop the motor as specified by *b1-03* [Stopping Method Selection].

## ■ Fine-Tuning PID

Fine-tune the following parameter settings to have PID control eliminate problems with overshoot and oscillation.

- *b5-02* [Proportional Gain (P)]
- *b5-03* [Integral Time (I)]
- *b5-05* [Derivative Time (D)]
- *b5-08* [PID Primary Delay Time Constant]

Purpose	Procedure	Results
Prevent overshoot.	<ul style="list-style-type: none"> <li>Set <i>b5-05 [Derivative Time (D)]</i> to a smaller value.</li> <li>Set <i>b5-03 [Integral Time (I)]</i> to a larger value.</li> </ul>	
Quickly stabilize control.	<ul style="list-style-type: none"> <li>Set <i>b5-05 [Derivative Time (D)]</i> to a larger value.</li> <li>Set <i>b5-03 [Integral Time (I)]</i> to a smaller value.</li> </ul>	
Prevent long-cycle oscillations.	Set <i>b5-03 [Integral Time (I)]</i> to a larger value.	
Prevent short-cycle oscillations.	<ul style="list-style-type: none"> <li>Set <i>b5-05 [Derivative Time (D)]</i> to a smaller value.</li> <li>If you set <i>b5-05 = 0.00 [Derivative Time (D) = disabling D control]</i> and it does not stop oscillation, then set <i>b5-02 [Proportional Gain (P)]</i> to a smaller value or set <i>b5-08 [PID Primary Delay Time Constant]</i> to a larger value.</li> </ul>	

### ■ EZ Sleep/Wake-up Functionality

Set *b5-89 = 1 [Sleep Method Selection = EZ Sleep/Wake-up]* to enable the EZ Sleep/Wake-up function.

**Note:**

- When *b5-89 = 0 [Sleep Mode Selection = Standard]*, the EZ Sleep function and related parameters are disabled. Parameter *b5-91 [EZ Minimum Speed]* is not included in this rule.
- Set *b5-89 = 1* to disable *b5-15 [PID Sleep Function Start Level]*.

Configuration Parameter	Description
<i>b5-90 [EZ Sleep Unit]</i>	<p>Sets the unit of measure for <i>b5-92 [EZ Sleep Level]</i>. When <i>b5-90 = 0 [0.1Hz units]</i>, the setting range of <i>b5-91 [EZ Minimum Speed]</i> is 0.0 to 590.0 Hz. When <i>b5-90 = 1 [rev/min]</i>, the setting range is 0 to 35400 min<sup>-1</sup> (r/min).</p> <p><b>Note:</b> When you change <i>b5-90</i>, the value of <i>b5-92</i> is not automatically updated.</p>
<i>b5-91 [EZ Minimum Speed]</i>	<p>This parameter sets the lower limit for PID output. The drive uses the largest value of <i>b5-91</i>, <i>b5-34 [PID Output Lower Limit]</i>, and <i>d2-02 [Frequency Reference Lower Limit]</i> to internally set the lower limit of PID output. The <i>b5-89</i> setting does not have an effect.</p>



Configuration Parameter	Description
<i>b5-92 [EZ Sleep Level]</i>	When the output frequency or motor speed is less than the value of <i>b5-92</i> for longer than the value of <i>b5-93 [EZ Sleep Time]</i> , the drive does to sleep.
<i>b5-95 = 0 [EZ Wake-up Mode = Absolute]</i>	When the PID feedback is less than the value of <i>b5-94 [EZ Wake-up Level]</i> for longer than the time set in <i>b5-96 [EZ Sleep Wake-up Time]</i> , the drive restarts operation from sleep.
<i>b5-95 = 1 [EZ Wake-up Mode = Setpoint Delta]</i>	When the PID feedback is less than the value set as the PID setpoint value minus <i>b5-94</i> for the time set in <i>b5-96</i> , the drive restarts operation from sleep.

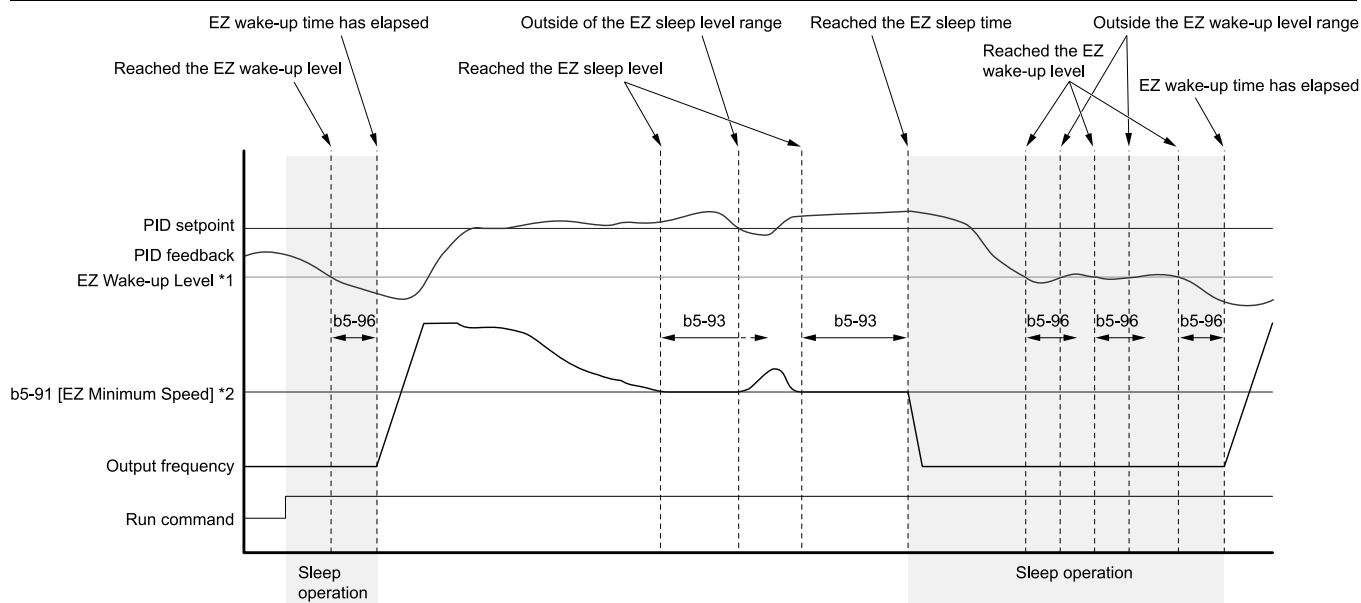


Figure 11.39 EZ Sleep/Wake-up Operation: PID Output is Normal and *b5-92* = 0.0 Hz

\*1 The values of *b5-94* and *b5-95* set operation.

\*2 In the example, *b5-92* is at the default setting of 0.0 Hz. *b5-91* is the EZ sleep level.

## ■ b5-01: PID Mode Setting

No. (Hex.)	Name	Description	Default (Range)
b5-01 (01A5)	PID Mode Setting	<div style="display: flex; gap: 5px;"> <span>V/f</span> <span>CL-V/f</span> <span>OLV</span> <span>CLV</span> <span>AOLV</span> <span>OLV/PM</span> <span>AOLV/PM</span> <span>CLV/PM</span> <span>EZOLV</span> </div> Sets the type of PID control.	0 (0 - 8)

**0 : Disabled**

**1 : Standard**

The drive does D control on the difference between the feedback value and the PID setpoint output through *U5-02 [PID Input]*.

**2 : Standard (D on feedback)**

The drive does D control on the feedback output through *U5-06 [PID Fdbk-Diff PID Fdbk]*.

**3 : Fref + PID Trim**

The drive adds the frequency reference to the PID output. The drive performs D control on the difference between the feedback value and the PID setpoint output via *U5-02 [PID Input]*.

**4 : Fref + PID Trim (D on feedback)**

The drive adds the frequency reference to the PID output. The drive performs D control on the feedback output via *U5-06 [PID Fdbk-Diff PID Fdbk]*.

**5 : Same as 7series & prior, b5-01=1**

**6 : Same as 7series & prior, b5-01=2**

**7 : Same as 7series & prior, b5-01=3**

**8 : Same as 7series & prior, b5-01=4**

Note:

Use settings 5 to 8 when the drive is a replacement for a previous generation drive.

■ **b5-02: Proportional Gain (P)**

No. (Hex.)	Name	Description	Default (Range)
b5-02 (01A6) RUN	Proportional Gain (P)	<b>V/f</b> <b>CL-V/f</b> <b>OLV</b> <b>CLV</b> <b>AOLV</b> <b>OLV/PM</b> <b>AOLV/PM</b> <b>CLV/PM</b> <b>EZOLV</b> Sets the proportional gain (P) that is applied to PID input.	1.00 (0.00 - 25.00)

Larger values decrease errors, but can cause oscillations. Smaller values let too much offset between the setpoint and feedback.

Set *b5-02* = 0.00 to disable P control.

■ **b5-03: Integral Time (I)**

No. (Hex.)	Name	Description	Default (Range)
b5-03 (01A7) RUN	Integral Time (I)	<b>V/f</b> <b>CL-V/f</b> <b>OLV</b> <b>CLV</b> <b>AOLV</b> <b>OLV/PM</b> <b>AOLV/PM</b> <b>CLV/PM</b> <b>EZOLV</b> Sets the integral time (I) that is applied to PID input.	1.0 s (0.0 - 360.0 s)

Set a short integral time in *b5-03* to remove the offset more quickly. If the integral time is too short, overshoot or oscillation can occur.

Set *b5-03* = 0.00 to disable I control.

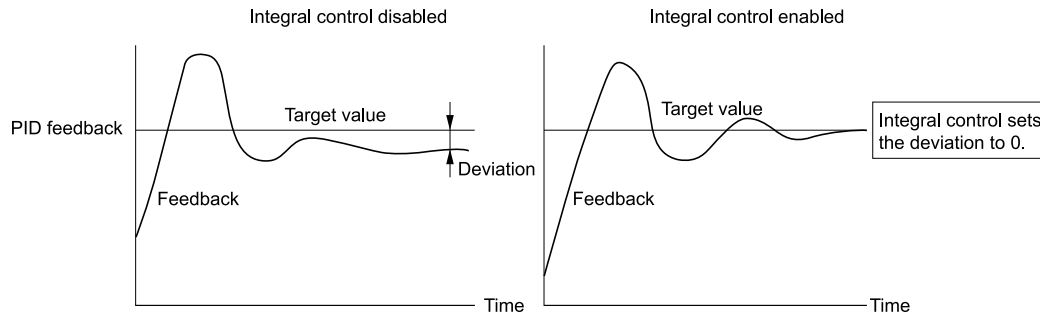


Figure 11.40 Integral Time and Deviation

■ **b5-04: Integral Limit**

No. (Hex.)	Name	Description	Default (Range)
b5-04 (01A8) RUN	Integral Limit	<b>V/f</b> <b>CL-V/f</b> <b>OLV</b> <b>CLV</b> <b>AOLV</b> <b>OLV/PM</b> <b>AOLV/PM</b> <b>CLV/PM</b> <b>EZOLV</b> Sets the upper limit for I control as a percentage of <i>E1-04</i> [Maximum Output Frequency].	100.0% (0.0 - 100.0%)

Applications with loads that quickly change will cause the output of the PID function to oscillate. Set this parameter to a low value to prevent oscillation, mechanical loss, and motor speed loss.

■ **b5-05: Derivative Time (D)**

No. (Hex.)	Name	Description	Default (Range)
b5-05 (01A9) RUN	Derivative Time (D)	<b>V/f</b> <b>CL-V/f</b> <b>OLV</b> <b>CLV</b> <b>AOLV</b> <b>OLV/PM</b> <b>AOLV/PM</b> <b>CLV/PM</b> <b>EZOLV</b> Sets the derivative time (D) for PID control. This parameter adjusts system responsiveness.	0.00 s (0.00 - 10.00 s)

Increase the time setting to increase controller responsiveness and possibly cause vibrations. Decrease the time setting to decrease overshoot and decrease controller responsiveness.

Set *b5-05* = 0.00 to disable D control.

### ■ b5-06: PID Output Limit

No. (Hex.)	Name	Description	Default (Range)
b5-06 (01AA) RUN	PID Output Limit	<b>V/f</b> <b>CL-V/f</b> <b>OLV</b> <b>CLV</b> <b>AOLV</b> <b>OLV/PM</b> <b>AOLV/PM</b> <b>CLV/PM</b> <b>EZOLV</b> Sets the maximum possible output from the PID controller as a percentage of <i>E1-04 [Maximum Output Frequency]</i> .	100.0% (0.0 - 100.0%)

### ■ b5-07: PID Offset Adjustment

No. (Hex.)	Name	Description	Default (Range)
b5-07 (01AB) RUN	PID Offset Adjustment	<b>V/f</b> <b>CL-V/f</b> <b>OLV</b> <b>CLV</b> <b>AOLV</b> <b>OLV/PM</b> <b>AOLV/PM</b> <b>CLV/PM</b> <b>EZOLV</b> Sets the offset for the PID control output as a percentage of <i>E1-04 [Maximum Output Frequency]</i> .	0.0% (-100.0 - +100.0%)

### ■ b5-08: PID Primary Delay Time Constant

No. (Hex.)	Name	Description	Default (Range)
b5-08 (01AC) Expert	PID Primary Delay Time Constant	<b>V/f</b> <b>CL-V/f</b> <b>OLV</b> <b>CLV</b> <b>AOLV</b> <b>OLV/PM</b> <b>AOLV/PM</b> <b>CLV/PM</b> <b>EZOLV</b> Sets the primary delay time constant for the PID control output. Usually it is not necessary to change this setting.	0.00 s (0.00 - 10.00 s)

Prevents resonance if there is a large quantity of mechanical friction or if rigidity is unsatisfactory. Set the value larger than the resonant frequency cycle. A value that is too large will decrease drive responsiveness.

### ■ b5-09: PID Output Level Selection

No. (Hex.)	Name	Description	Default (Range)
b5-09 (01AD)	PID Output Level Selection	<b>V/f</b> <b>CL-V/f</b> <b>OLV</b> <b>CLV</b> <b>AOLV</b> <b>OLV/PM</b> <b>AOLV/PM</b> <b>CLV/PM</b> <b>EZOLV</b> Sets the polarity of the PID output.	0 (0, 1)

Use this parameter in applications that decrease the drive output frequency when you increase the PID setpoint.

#### 0 : Normal Output (Direct Acting)

A positive PID input increases the PID output (direct acting).

#### 1 : Reverse Output (Reverse Acting)

A positive PID input decreases the PID output (reverse acting).

### ■ b5-10: PID Output Gain Setting

No. (Hex.)	Name	Description	Default (Range)
b5-10 (01AE) RUN	PID Output Gain Setting	<b>V/f</b> <b>CL-V/f</b> <b>OLV</b> <b>CLV</b> <b>AOLV</b> <b>OLV/PM</b> <b>AOLV/PM</b> <b>CLV/PM</b> <b>EZOLV</b> Sets the amount of gain to apply to the PID output.	1.00 (0.00 - 25.00)

Applies a gain to the PID output and can help when  $b5-01 = 3$  or  $4$  [*PID Mode Setting = Fref + PID Trim, Fref + PID Trim (D on feedback)*].

### ■ b5-11: PID Output Reverse Selection

No. (Hex.)	Name	Description	Default (Range)
b5-11 (01AF)	PID Output Reverse Selection	<b>V/f</b> <b>CL-V/f</b> <b>OLV</b> <b>CLV</b> <b>AOLV</b> <b>OLV/PM</b> <b>AOLV/PM</b> <b>CLV/PM</b> <b>EZOLV</b> Sets the function that enables and disables reverse motor rotation for negative PID control output.	0 (0, 1)

## 11.3 b: Application

This parameter is disabled when  $b5-01 = 3, 4$  [*PID Mode Setting = Fref + PID Trim, Fref + PID Trim (D on feedback)*]. There is no limit for PID output (PID output can be positive or negative). Operates the same as setting "1: Enabled: Negative lower limit".

### 0 : Lower Limit is Zero

When PID output is negative, PID output is limited to 0 and drive output is shut off.

### 1 : Negative Output Accepted

When the PID output is negative, the motor will rotate in reverse.

## ■ b5-12: Feedback Loss Detection Select

No. (Hex.)	Name	Description	Default (Range)
b5-12 (01B0)	Feedback Loss Detection Select	<div style="display: flex; justify-content: space-between; font-size: 0.8em; font-weight: bold; margin-bottom: 5px;"> <span>V/f</span> <span>CL-V/f</span> <span>OLV</span> <span>CLV</span> <span>AOLV</span> <span>OLV/PM</span> <span>AOLV/PM</span> <span>CLV/PM</span> <span>EZOLV</span> </div> Sets the drive response to PID feedback loss. Sets drive operation after the drive detects PID feedback loss.	0 (0 - 5)

### 0 : Digital Out Only, Always Detect

The MFDO terminal set for *PID Feedback Low* or *PID Feedback High* [ $H2-01$  to  $H2-03 = 3E, 3F$ ] activates. When the drive detects feedback loss, the keypad will not show an alarm and the drive will continue operation.

When the feedback signal is less than the level set in  $b5-13$  [*PID Feedback Loss Detection Lvl*] for longer than the time set in  $b5-14$  [*PID Feedback Loss Detection Time*], the MFDO terminal set for a *PID Feedback Low* activates.

When the feedback signal is more than the level set in  $b5-36$  [*PID High Feedback Detection Lvl*] for longer than the time set in  $b5-37$  [*PID High Feedback Detection Time*] the MFDO terminal set for a *PID Feedback High* activates.

When the feedback value is not in the detection range, the drive resets the fault output.

### 1 : Alarm + Digital Out, Always Det

The drive detects *FbL* [*PID Feedback Loss*] and *FbH* [*Excessive PID Feedback*]. The MFDO terminal set for *PID Feedback Low* or *PID Feedback High* [ $H2-01$  to  $H2-03 = 3E, 3F$ ] activates. The output terminal set for *Alarm* [ $H2-01$  to  $H2-03 = 10$ ] activates and the drive continues operation.

When the feedback signal is less than the level set in  $b5-13$  for longer than the time set in  $b5-14$ , the MFDO terminal set for a *PID Feedback Low* activates.

When the feedback signal is more than the level set in  $b5-36$  for longer than the time set in  $b5-37$ , the MFDO terminal set for a *PID Feedback High* activates.

When the feedback value is not in the detection range, the drive resets the fault output.

### 2 : Fault + Digital Out, Always Det

The drive detects *FbL* and *FbH*. The output terminal set for *Fault* [ $H2-01$  to  $H2-03 = E$ ] activates and the motor coasts to stop.

When the feedback signal is less than the level set in  $b5-13$  for the time set in  $b5-14$ , the drive detects *FbL*.

When the feedback signal is more than the level set in  $b5-36$  for the time set in  $b5-37$ , the drive detects *FbH*.

### 3 : Digital Out Only, @PID Enable

The MFDO terminal set for *PID Feedback Low* or *PID Feedback High* activates. When the drive detects feedback loss, the keypad will not show an alarm and the drive will continue operation.

When the MFDI terminal set to *PID Disable* [ $H1-xx = 19$ ] activates, the drive disables fault detection.

### 4 : Alarm + Digital Out, @PID Enable

The drive detects *FbL* and *FbH*. The MFDO terminal set for *PID Feedback Low* or *PID Feedback High* activates. The output terminal set for *Alarm* [ $H2-01$  to  $H2-03 = 10$ ] activates and the drive continues operation.

When the MFDI terminal set to *PID Disable* [ $H1-xx = 19$ ] activates, the drive disables fault detection.

### 5 : Fault + Digital Out, @PID Enable

The drive detects *FbL* and *FbH*. The output terminal set for *Fault* [ $H2-01$  to  $H2-03 = E$ ] activates and the motor coasts to stop.

When the MFDI terminal set to *PID Disable* [ $H1-xx = 19$ ] activates, the drive disables fault detection.

### ■ b5-13: PID Feedback Loss Detection Lvl

No. (Hex.)	Name	Description	Default (Range)
b5-13 (01B1)	PID Feedback Loss Detection Lvl	<b>V/f</b> <b>CL-V/f</b> <b>OLV</b> <b>CLV</b> <b>AOLV</b> <b>OLV/PM</b> <b>AOLV/PM</b> <b>CLV/PM</b> <b>EZOLV</b> Sets the level that triggers <i>PID Feedback Loss [FbL]</i> as a percentage of <i>E1-04 [Maximum Output Frequency]</i> .	0% (0 - 100%)

The drive detects *PID Feedback Loss [FbL]* when the feedback signal decreases to less than the level set in *b5-13* for longer than the time set in *b5-14 [PID Feedback Loss Detection Time]*.

### ■ b5-14: PID Feedback Loss Detection Time

No. (Hex.)	Name	Description	Default (Range)
b5-14 (01B2)	PID Feedback Loss Detection Time	<b>V/f</b> <b>CL-V/f</b> <b>OLV</b> <b>CLV</b> <b>AOLV</b> <b>OLV/PM</b> <b>AOLV/PM</b> <b>CLV/PM</b> <b>EZOLV</b> Sets the length of time that PID Feedback must be less than <i>b5-13 [PID Feedback Loss Detection Lvl]</i> to detect <i>PID Feedback Loss [FbL]</i> .	1.0 s (0.0 - 25.5 s)

### ■ b5-15: PID Sleep Function Start Level

No. (Hex.)	Name	Description	Default (Range)
b5-15 (01B3)	PID Sleep Function Start Level	<b>V/f</b> <b>CL-V/f</b> <b>OLV</b> <b>CLV</b> <b>AOLV</b> <b>OLV/PM</b> <b>AOLV/PM</b> <b>CLV/PM</b> <b>EZOLV</b> Sets the output level that triggers the PID Sleep function.	Determined by A1-02 (0.0 - 590.0)

The drive goes into Sleep mode when the PID output or frequency reference is less than *b5-15* for longer than the time set to *b5-16 [PID Sleep Delay Time]*. The drive continues operation when the PID output or frequency reference is more than *b5-15* for longer than the time set to *b5-16*.

### ■ b5-16: PID Sleep Delay Time

No. (Hex.)	Name	Description	Default (Range)
b5-16 (01B4)	PID Sleep Delay Time	<b>V/f</b> <b>CL-V/f</b> <b>OLV</b> <b>CLV</b> <b>AOLV</b> <b>OLV/PM</b> <b>AOLV/PM</b> <b>CLV/PM</b> <b>EZOLV</b> Sets a delay time to start or stop the PID Sleep function.	0.0 s (0.0 - 25.5 s)

### ■ b5-17: PID Accel/Decel Time

No. (Hex.)	Name	Description	Default (Range)
b5-17 (01B5)	PID Accel/Decel Time	<b>V/f</b> <b>CL-V/f</b> <b>OLV</b> <b>CLV</b> <b>AOLV</b> <b>OLV/PM</b> <b>AOLV/PM</b> <b>CLV/PM</b> <b>EZOLV</b> Raises or lowers the PID setpoint using the acceleration and deceleration times set to the drive. This is a soft-starter for the PID setpoint.	0.0 s (0.0 - 6000.0 s)

The drive usually uses the acceleration and deceleration times set in *C1-xx [Accel and Decel Times]*, but when PID control is enabled, the drive applies *C1-xx* after PID output. If you frequently change the PID setpoint, the drive responsiveness decreases. When resonance with PID control causes hunting, overshoot, or undershoot, set *b5-17* for longer acceleration and deceleration times.

Decrease *C1-xx* until hunting stops, then use *b5-17* to check the acceleration and deceleration. To enable and disable the setting in *b5-17* through an MFDI terminal, set *PID Soft Starter Disable [H1-xx = 34]*.

### ■ b5-18: b5-19 PID Setpoint Selection

No. (Hex.)	Name	Description	Default (Range)
b5-18 (01DC)	b5-19 PID Setpoint Selection	<b>V/f</b> <b>CL-V/f</b> <b>OLV</b> <b>CLV</b> <b>AOLV</b> <b>OLV/PM</b> <b>AOLV/PM</b> <b>CLV/PM</b> <b>EZOLV</b> Sets the function that enables and disables <i>b5-19 [PID Setpoint Value]</i> .	0 (0, 1)

#### 0 : Disabled

The drive does not use the value set in *b5-19* as the PID setpoint.

#### 1 : Enabled

The drive uses the value set in *b5-19* as the PID setpoint.

■ **b5-19: PID Setpoint Value**

No. (Hex.)	Name	Description	Default (Range)
b5-19 (01DD) RUN	PID Setpoint Value	<b>V/f</b> <b>CL-V/f</b> <b>OLV</b> <b>CLV</b> <b>AOLV</b> <b>OLV/PM</b> <b>AOLV/PM</b> <b>CLV/PM</b> <b>EZOLV</b> Sets the PID setpoint when <i>b5-18 = 1</i> [ <i>b5-19 PID Setpoint Selection = Enabled</i> ].	0.00% (0.00 - 100.00%)

■ **b5-20: PID Unit Selection**

No. (Hex.)	Name	Description	Default (Range)
b5-20 (01E2)	PID Unit Selection	<b>V/f</b> <b>CL-V/f</b> <b>OLV</b> <b>CLV</b> <b>AOLV</b> <b>OLV/PM</b> <b>AOLV/PM</b> <b>CLV/PM</b> <b>EZOLV</b> Sets the units to set and show <i>b5-19</i> [ <i>PID Setpoint Value</i> ].	1 (0 - 3)

**0 : 0.01Hz units**

The drive uses 0.01 Hz units.

**1 : 0.01% units**

The drive uses 0.01% units. Set the value as a percentage of *E1-04* [*Maximum Output Frequency*].

**2 : min<sup>-1</sup>**

The drive uses 1 min<sup>-1</sup> unit. Set *E2-04*, *E4-04*, or *E5-04* [*Motor Pole Count*].

**3 : User Units**

The drive uses units set in *b5-38* [*PID User Unit Display Scaling*] and *b5-39* [*PID User Unit Display Digits*] to show the PID setpoint in *U5-01*, *U5-04*, *U5-06* [*PID Feedback*, *PID Setpoint*, *PID Fdbk-Diff* *PID Fdbk*].

■ **b5-34: PID Output Lower Limit Level**

No. (Hex.)	Name	Description	Default (Range)
b5-34 (019F) RUN	PID Output Lower Limit Level	<b>V/f</b> <b>CL-V/f</b> <b>OLV</b> <b>CLV</b> <b>AOLV</b> <b>OLV/PM</b> <b>AOLV/PM</b> <b>CLV/PM</b> <b>EZOLV</b> Sets the output lower limit for the PID control as a percentage of <i>E1-04</i> [ <i>Maximum Output Frequency</i> ].	0.0% (-100.0 - +100.0%)

Use a lower limit to keep PID control output from dropping below a fixed level.

Set this parameter to 0.0% to disable this function.

■ **b5-35: PID Input Limit Level**

No. (Hex.)	Name	Description	Default (Range)
b5-35 (01A0) RUN	PID Input Limit Level	<b>V/f</b> <b>CL-V/f</b> <b>OLV</b> <b>CLV</b> <b>AOLV</b> <b>OLV/PM</b> <b>AOLV/PM</b> <b>CLV/PM</b> <b>EZOLV</b> Sets the input upper limit for the PID control as a percentage of <i>E1-04</i> [ <i>Maximum Output Frequency</i> ].	1000.0% (0.0 - 1000.0%)

A large input value for PID control makes a high output. The drive applies this limit to the negative and positive domains.

■ **b5-36: PID High Feedback Detection Lvl**

No. (Hex.)	Name	Description	Default (Range)
b5-36 (01A1)	PID High Feedback Detection Lvl	<b>V/f</b> <b>CL-V/f</b> <b>OLV</b> <b>CLV</b> <b>AOLV</b> <b>OLV/PM</b> <b>AOLV/PM</b> <b>CLV/PM</b> <b>EZOLV</b> Sets the level that triggers <i>Excessive PID Feedback</i> [ <i>FbH</i> ] as a percentage of <i>E1-04</i> [ <i>Maximum Output Frequency</i> ].	100% (0 - 100%)

When the feedback signal increases to more than the level set in *b5-36* for the time set in *b5-37* [*PID High Feedback Detection Time*], the drive will detect *Excessive PID Feedback* [*FbH*].

### ■ b5-37: PID High Feedback Detection Time

No. (Hex.)	Name	Description	Default (Range)
b5-37 (01A2)	PID High Feedback Detection Time	<b>V/f</b> <b>CL-V/f</b> <b>OLV</b> <b>CLV</b> <b>AOLV</b> <b>OLV/PM</b> <b>AOLV/PM</b> <b>CLV/PM</b> <b>EZOLV</b> Sets the length of time that the feedback signal must be more than the level set in <i>b5-36 [PID High Feedback Detection Lvl]</i> to cause <i>Excessive PID Feedback [FbH]</i> .	1.0 s (0.0 - 25.5 s)

### ■ b5-38: PID User Unit Display Scaling

No. (Hex.)	Name	Description	Default (Range)
b5-38 (01FE)	PID User Unit Display Scaling	<b>V/f</b> <b>CL-V/f</b> <b>OLV</b> <b>CLV</b> <b>AOLV</b> <b>OLV/PM</b> <b>AOLV/PM</b> <b>CLV/PM</b> <b>EZOLV</b> Sets the display for <i>U5-01, U5-04</i> when the drive operates at the maximum output frequency.	Determined by b5-20 (1 - 60000)

The drive uses this parameter and *b5-39 [PID User Unit Display Digits]* together.

When *b5-20 = 3 [PID Unit Selection = User Units]*, the drive applies user-set PID setpoint and display units to *U5-01 [PID Feedback]* and *U5-04 [PID Setpoint]*.

### ■ b5-39: PID User Unit Display Digits

No. (Hex.)	Name	Description	Default (Range)
b5-39 (01FF)	PID User Unit Display Digits	<b>V/f</b> <b>CL-V/f</b> <b>OLV</b> <b>CLV</b> <b>AOLV</b> <b>OLV/PM</b> <b>AOLV/PM</b> <b>CLV/PM</b> <b>EZOLV</b> Sets the number of digits to set and show the PID setpoint.	Determined by b5-20 (0 - 3)

The drive uses this parameter and *b5-38 [PID User Unit Display Scaling]* together.

When parameter *b5-20 = 3 [PID Unit Selection = User Units]*, the drive applies user-set PID setpoint and display units to *U5-01 [PID Feedback]* and *U5-04 [PID Setpoint]*

**0 : No Decimal Places (XXXXX)**

**1 : One Decimal Places (XXXX.X)**

**2 : Two Decimal Places (XXX.XX)**

**3 : Three Decimal Places (XX.XXX)**

### ■ b5-40: Frequency Reference Monitor @PID

No. (Hex.)	Name	Description	Default (Range)
b5-40 (017F)	Frequency Reference Monitor @PID	<b>V/f</b> <b>CL-V/f</b> <b>OLV</b> <b>CLV</b> <b>AOLV</b> <b>OLV/PM</b> <b>AOLV/PM</b> <b>CLV/PM</b> <b>EZOLV</b> Sets the contents for monitor <i>U1-01 [Frequency Reference]</i> in PID control.	0 (0, 1)

**0 : U1-01 Includes PID Output**

Monitor *U1-01* shows the frequency reference that was increased or decreased by the PID output.

**1 : U1-01 Excludes PID Output**

Monitor *U1-01* shows the actual frequency reference.

### ■ b5-47: PID Trim Mode Output Reverse Sel

No. (Hex.)	Name	Description	Default (Range)
b5-47 (017D)	PID Trim Mode Output Reverse Sel	<b>V/f</b> <b>CL-V/f</b> <b>OLV</b> <b>CLV</b> <b>AOLV</b> <b>OLV/PM</b> <b>AOLV/PM</b> <b>CLV/PM</b> <b>EZOLV</b> Sets reverse motor rotation when the PID control output is negative.	1 (0, 1)

Set *b5-01 = 3 or 4 [PID Mode Setting = Fref + PID Trim, Fref + PID Trim (D on feedback)]* to enable this parameter.

**0 : Lower Limit is Zero**

When PID output is negative, PID output is limited to 0 and drive output is shut off.

**1 : Negative Output Accepted**

When the PID output is negative, the motor will rotate in reverse.

■ **b5-53: PID Integrator Ramp Limit**

No. (Hex.)	Name	Description	Default (Range)
b5-53 (0B8F) RUN	PID Integrator Ramp Limit	<b>V/f</b> <b>CL-V/f</b> <b>OLV</b> <b>CLV</b> <b>AOLV</b> <b>OLV/PM</b> <b>AOLV/PM</b> <b>CLV/PM</b> <b>EZOLV</b> Sets the responsiveness of PID control when the PID feedback changes quickly.	0.0 Hz (0.0 - 10.0 Hz)

**Note:**

- This parameter is disabled when set to 0.0 Hz.
- When the integrator ramp limit is enabled (*b5-53 > 0.0 Hz*), the PID integrator value limit is the range set by the output frequency  $\pm b5-53$ .
- When the PID feedback changes quickly, gradually decrease the value of this parameter in increments of 0.1 Hz to decrease the speed of the response of PID control.

■ **b5-54: PID Softstarter Cancel Selection**

No. (Hex.)	Name	Description	Default (Range)
b5-54 (0BB7)	PID Softstarter Cancel Selection	<b>V/f</b> <b>CL-V/f</b> <b>OLV</b> <b>CLV</b> <b>AOLV</b> <b>OLV/PM</b> <b>AOLV/PM</b> <b>CLV/PM</b> <b>EZOLV</b> Sets how the soft-starter responds to PID input/output.	0 (0, 1)

Table 11.32 shows how the soft-starter responds to PID input/output.

**Table 11.32 Soft Starter and PID Input/Output**

Selection	PID Frequency Reference Input	PID Frequency Reference Output	Soft Starter Input	Soft Starter Output
Soft Starter 1	Frequency Reference	Soft Starter Input	PID Frequency Reference Output	Output frequency
Soft Starter 2	Soft Starter Output	Output frequency	Frequency Reference	PID Frequency Reference Input

**0 : Disabled**

The soft starter process occurs downstream from the PID function. The PID function input functions as the frequency reference, the PID function output functions as the soft starter input, and the soft starter output functions as the output frequency.

**1 : Enabled**

The soft starter process occurs upstream from the PID function. The soft starter input functions as the frequency reference, the soft starter output functions as the soft starter input, and the PID function output functions as the output frequency.

■ **b5-55: PID Feedback Monitor Selection**

No. (Hex.)	Name	Description	Default (Range)
b5-55 (0BE1)	PID Feedback Monitor Selection	<b>V/f</b> <b>CL-V/f</b> <b>OLV</b> <b>CLV</b> <b>AOLV</b> <b>OLV/PM</b> <b>AOLV/PM</b> <b>CLV/PM</b> <b>EZOLV</b> Sets the monitor for PID Feedback ( <i>Ux-xx</i> ).	000 (000 - 999)

**Note:**

- You cannot select *parameter U5-xx*.
- This parameter is disabled when set to 000.

■ **b5-56: PID Feedback Monitor Gain**

No. (Hex.)	Name	Description	Default (Range)
b5-56 (0BE2)	PID Feedback Monitor Gain	<b>V/f</b> <b>CL-V/f</b> <b>OLV</b> <b>CLV</b> <b>AOLV</b> <b>OLV/PM</b> <b>AOLV/PM</b> <b>CLV/PM</b> <b>EZOLV</b> Sets the gain for the monitor specified in <i>b5-55 [PID Feedback Monitor Selection]</i> .	1.00 (0.00 - 10.00)

**Note:**

Set *b5-18 = 1 [b5-19 PID Setpoint Selection = Enabled]* to enable this parameter.



### ■ b5-57: PID Feedback Monitor Bias

No. (Hex.)	Name	Description	Default (Range)
b5-57 (11DD)	PID Feedback Monitor Bias	<b>V/f</b> <b>CL-V/f</b> <b>OLV</b> <b>CLV</b> <b>AOLV</b> <b>OLV/PM</b> <b>AOLV/PM</b> <b>CLV/PM</b> <b>EZOLV</b> Sets the bias for the monitor specified in <i>b5-55 [PID Feedback Monitor Selection]</i> .	0.00 (-10.00 - +10.00)

### ■ b5-58 to b5-60: PID Setpoints 2 to 4

No. (Hex.)	Name	Description	Default (Range)
b5-58 to b5-60 (1182 - 1184) RUN	PID Setpoints 2 to 4	<b>V/f</b> <b>CL-V/f</b> <b>OLV</b> <b>CLV</b> <b>AOLV</b> <b>OLV/PM</b> <b>AOLV/PM</b> <b>CLV/PM</b> <b>EZOLV</b> Sets the PID setpoint when <i>H1-xx = 3E or 3F [MFDI Function Select = PID Setpoint Selection 1/2]</i> . This value is a percentage where <i>E1-04 [Maximum Output Frequency]</i> setting = a setting value of 100%.	0.00% (0.00 - 100.00%)

Table 11.33 shows how the different MFDI *H1-xx* values (*3E* and *3F*) have an effect on the PID setpoint value.

Table 11.33 Switching of MFDI and PID Setpoint Value

H1-xx = 3E	H1-xx = 3F	PID Setpoint Value
OFF	OFF	No switch
ON	OFF	b5-58 [PID Setpoint2]
OFF	ON	b5-59 [PID Setpoint3]
ON	ON	b5-60 [PID Setpoint4]

### ■ b5-61: PID Trim Mode Lower Limit Sel

No. (Hex.)	Name	Description	Default (Range)
b5-61 (119A)	PID Trim Mode Lower Limit Sel	<b>V/f</b> <b>CL-V/f</b> <b>OLV</b> <b>CLV</b> <b>AOLV</b> <b>OLV/PM</b> <b>AOLV/PM</b> <b>CLV/PM</b> <b>EZOLV</b> Sets the function that adjusts the PID output in relation to the frequency reference.	0 (0, 1)

#### 0 : Disabled

Does not adjust the PID output with the frequency reference.

#### 1 : Enabled

Adjusts the PID output in relation to the frequency reference. The setting value of *b5-62 [PID Trim Mode Lower Limit Value]* sets the lower limit of the post-adjustment value. The maximum output frequency sets the upper limit.

#### Note:

- Set *b5-01 = 3, 4, 7, or 8* to enable this parameter.
- When *b5-61 = 1*, you can use this formula to adjust PID output proportional to the frequency reference:

$$U5-03 = U5-03 \times \left| \frac{Fref}{Fmax} \right|^{*1}$$

*U5-03 [PID Output]*, *Fref [Frequency Reference]*, and *Fmax [Maximum Output Frequency]*

\*1 Lower limit = *b5-62*, Upper limit = Maximum output frequency

### ■ b5-62: PID Trim Mode Lower Limit Value

No. (Hex.)	Name	Description	Default (Range)
b5-62 (119B)	PID Trim Mode Lower Limit Value	<b>V/f</b> <b>CL-V/f</b> <b>OLV</b> <b>CLV</b> <b>AOLV</b> <b>OLV/PM</b> <b>AOLV/PM</b> <b>CLV/PM</b> <b>EZOLV</b> Sets the lower limit of the PID frequency reference trim as a percentage where <i>E1-04 [Maximum Output Frequency]</i> setting = a setting value of 100%.	0.00% (0.00 - 100.00%)

#### Note:

Set *b5-01 = 3, 4, 7, or 8* to enable this parameter.

### ■ b5-63: PID Differential FB Monitor Sel

No. (Hex.)	Name	Description	Default (Range)
b5-63 (119C)	PID Differential FB Monitor Sel	<b>V/f</b> <b>CL-V/f</b> <b>OLV</b> <b>CLV</b> <b>AOLV</b> <b>OLV/PM</b> <b>AOLV/PM</b> <b>CLV/PM</b> <b>EZOLV</b> Sets the monitor for PID Differential Feedback ( <i>Ux-xx</i> ).	000 (000 - 999)

**Note:**

- You cannot select *parameter U5-xx*.
- This parameter is disabled when set to 000.

### ■ b5-64: PID Differential FB Monitor Gain

No. (Hex.)	Name	Description	Default (Range)
b5-64 (119D)	PID Differential FB Monitor Gain	<b>V/f</b> <b>CL-V/f</b> <b>OLV</b> <b>CLV</b> <b>AOLV</b> <b>OLV/PM</b> <b>AOLV/PM</b> <b>CLV/PM</b> <b>EZOLV</b> Sets the gain for the monitor specified in <i>b5-63</i> [ <i>PID Differential FB Monitor Sel</i> ].	1.00 (0.00 - 10.00)

**Note:**

Set *b5-18 = 1* [*b5-19 PID Setpoint Selection = Enabled*] to enable this parameter.

### ■ b5-65: PID Differential FB Monitor Bias

No. (Hex.)	Name	Description	Default (Range)
b5-65 (119F)	PID Differential FB Monitor Bias	<b>V/f</b> <b>CL-V/f</b> <b>OLV</b> <b>CLV</b> <b>AOLV</b> <b>OLV/PM</b> <b>AOLV/PM</b> <b>CLV/PM</b> <b>EZOLV</b> Sets the bias for the monitor specified in <i>b5-63</i> [ <i>PID Differential FB Monitor Sel</i> ].	0.00 (-10.00 - +10.00)

**Note:**

Set *b5-18 = 1* [*b5-19 PID Setpoint Selection = Enabled*] to enable this parameter.

### ■ b5-66: PID Feedback Monitor Level

No. (Hex.)	Name	Description	Default (Range)
b5-66 (11DE)	PID Feedback Monitor Level	<b>V/f</b> <b>CL-V/f</b> <b>OLV</b> <b>CLV</b> <b>AOLV</b> <b>OLV/PM</b> <b>AOLV/PM</b> <b>CLV/PM</b> <b>EZOLV</b> Sets the signal level for the monitor specified in <i>b5-55</i> [ <i>PID Feedback Monitor Selection</i> ].	0 (0, 1)

0 : Absolute

1 : Bi-directional (+/-)

### ■ b5-67: PID Differential FB Monitor Lvl

No. (Hex.)	Name	Description	Default (Range)
b5-67 (11DF)	PID Differential FB Monitor Lvl	<b>V/f</b> <b>CL-V/f</b> <b>OLV</b> <b>CLV</b> <b>AOLV</b> <b>OLV/PM</b> <b>AOLV/PM</b> <b>CLV/PM</b> <b>EZOLV</b> Sets the signal level for the monitor specified in <i>b5-63</i> [ <i>PID Differential FB Monitor Sel</i> ].	0 (0, 1)

0 : Absolute

1 : Bi-directional (+/-)

### ■ b5-89: Sleep Method Selection

No. (Hex.)	Name	Description	Default (Range)
b5-89 (0B89) RUN	Sleep Method Selection	<b>V/f</b> <b>CL-V/f</b> <b>OLV</b> <b>CLV</b> <b>AOLV</b> <b>OLV/PM</b> <b>AOLV/PM</b> <b>CLV/PM</b> <b>EZOLV</b> Sets sleep and wake up operation when using PID.	0 (0, 1)

0 : Standard

1 : EZ Sleep/Wake-up

### ■ b5-90: EZ Sleep Unit

No. (Hex.)	Name	Description	Default (Range)
b5-90 (0B90)	EZ Sleep Unit	<b>V/f</b> <b>CL-V/f</b> <b>OLV</b> <b>CLV</b> <b>AOLV</b> <b>OLV/PM</b> <b>AOLV/PM</b> <b>CLV/PM</b> <b>EZOLV</b> Sets the measurement units for <i>b5-91 [EZ Sleep Minimum Speed]</i> and <i>b5-92 [EZ Sleep Level]</i> .	0 (0, 1)

0 : 0.1Hz units

1 : rev/min

### ■ b5-91: EZ Sleep Minimum Speed

No. (Hex.)	Name	Description	Default (Range)
b5-91 (0B91) RUN	EZ Sleep Minimum Speed	<b>V/f</b> <b>CL-V/f</b> <b>OLV</b> <b>CLV</b> <b>AOLV</b> <b>OLV/PM</b> <b>AOLV/PM</b> <b>CLV/PM</b> <b>EZOLV</b> Sets the minimum speed for the EZ Sleep/Wakeup function. This parameter uses the largest value from <i>b5-91</i> , <i>b5-34 [PID Output Lower Limit Level]</i> , and <i>d2-02 [Frequency Reference Lower Limit]</i> .	0.0 Hz or 0 min <sup>-1</sup> (r/min) (0.0 to 590.0 Hz or 0 to 35400 min <sup>-1</sup> (r/min))

**Note:**

The value of *b5-90 [EZ Sleep Unit]* sets the units. When *b5-90* changes, this parameter does not automatically update. Set this parameter again after you change *b5-90* is changed.

### ■ b5-92: EZ Sleep Level

No. (Hex.)	Name	Description	Default (Range)
b5-92 (0B92) RUN	EZ Sleep Level	<b>V/f</b> <b>CL-V/f</b> <b>OLV</b> <b>CLV</b> <b>AOLV</b> <b>OLV/PM</b> <b>AOLV/PM</b> <b>CLV/PM</b> <b>EZOLV</b> Sets the value that the output frequency or motor speed must be less than for longer than <i>b5-93 [EZ Sleep Time]</i> to enter Sleep Mode.	0.0 Hz or 0 min <sup>-1</sup> (r/min) (0.0 to 590.0 Hz or 0 to 35400 min <sup>-1</sup> (r/min))

**Note:**

When *b5-90 [EZ Sleep Unit]* changes, this parameter does not automatically update. Set this parameter again after you change *b5-90*.

### ■ b5-93: EZ Sleep Time

No. (Hex.)	Name	Description	Default (Range)
b5-93 (0B93) RUN	EZ Sleep Time	<b>V/f</b> <b>CL-V/f</b> <b>OLV</b> <b>CLV</b> <b>AOLV</b> <b>OLV/PM</b> <b>AOLV/PM</b> <b>CLV/PM</b> <b>EZOLV</b> Sets the length of time that the output frequency or motor speed must be less than <i>b5-92 [EZ Sleep Level]</i> to enter Sleep Mode.	5.0 s (0.0 - 1000.0 s)

### ■ b5-94: EZ Sleep Wake-up Level

No. (Hex.)	Name	Description	Default (Range)
b5-94 (0B94) RUN	EZ Sleep Wake-up Level	<b>V/f</b> <b>CL-V/f</b> <b>OLV</b> <b>CLV</b> <b>AOLV</b> <b>OLV/PM</b> <b>AOLV/PM</b> <b>CLV/PM</b> <b>EZOLV</b> Sets the level at which the drive resumes operation when exiting Sleep Mode.	0.00% (0.00 - 600.00%)

**Note:**

The values of *b5-20 [PID Unit Selection]*, *b5-38 [PID User Unit Display Scaling]*, and *b5-39 [PID User Unit Display Digits]* set the units. When *b5-20*, *b5-38*, and *b5-39* change, this parameter does not automatically update. Set this parameter again after you change *b5-20*, *b5-38*, and *b5-39* are changed.

- When *b5-95 = 0 [EZ Sleep Wake-up Mode = Absolute]*:  
When *b5-09 = 0 [PID Output Level Selection = Normal Output (Direct Acting)]*, and the PID Feedback [*H3-xx = B*] is less than the value of *b5-94* for a time longer than the value of *b5-96 [EZ Sleep Wake-up Time]*, the drive will exit sleep and start operation again. When *b5-09 = 1 [Reverse Output (Reverse Acting)]*, and the PID feedback is more than setting value of *b5-94* for a time longer than the setting value of *b5-96*, the drive will exit sleep and start operation again.
- When *b5-95 = 1 [Setpoint Delta]*:

When  $b5-09 = 0$ , and the PID feedback is less than the value of “PID setpoint value -  $b5-94$ ” for a time longer than the value of  $b5-96$ , the drive will exit sleep and start operation again. When  $b5-09 = 1$ , and the PID feedback is more than the value of “PID setpoint value +  $b5-94$ ” for a time longer than the setting value of  $b5-96$ , the drive will exit sleep and start operation again.

■ **b5-95: EZ Sleep Wake-up Mode**

No. (Hex.)	Name	Description	Default (Range)
b5-95 (0B95)	EZ Sleep Wake-up Mode	<b>V/f</b> <b>CL-V/f</b> <b>OLV</b> <b>CLV</b> <b>AOLV</b> <b>OLV/PM</b> <b>AOLV/PM</b> <b>CLV/PM</b> <b>EZOLV</b> Sets the wake-up mode to use when exiting Sleep Mode.	0 (0, 1)

0 : Absolute

1 : Setpoint Delta

■ **b5-96: EZ Sleep Wake-up Time**

No. (Hex.)	Name	Description	Default (Range)
b5-96 (0B96)	EZ Sleep Wake-up Time	<b>V/f</b> <b>CL-V/f</b> <b>OLV</b> <b>CLV</b> <b>AOLV</b> <b>OLV/PM</b> <b>AOLV/PM</b> <b>CLV/PM</b> <b>EZOLV</b> Sets the EZ Wake-up time.	1.0 s (0.0 - 1000.0 s)

When the PID feedback is less than the value of  $b5-94$  [EZ Sleep Wake-up Level] continuously for the time set in  $b5-96$ , the drive will exit sleep and start operation again.

◆ **b6: Dwell Function**

The Dwell function momentarily holds the output frequency at start and stop.

This prevents motor speed loss when you start and stop heavy loads. The Dwell function is also enabled when backlash on the machine side causes sudden movement at the start of acceleration and deceleration.

At the start of acceleration, the drive uses the output frequency and acceleration time set for the Dwell function to automatically operate at low speed to minimize the effects of backlash. Then, the drive can accelerate again. The Dwell function operates the same for deceleration.

For conveyor applications, the Dwell function also lets the drive interlock the output frequency and a delay time for the holding brake on the load side.

The Dwell function momentarily stops during acceleration to prevent a PM motor from stepping out. [Figure 11.41](#) shows how the Dwell function works.

**Note:**

When you use the Dwell function at stop, set  $b1-03 = 0$  [Stopping Method Selection = Ramp to Stop].

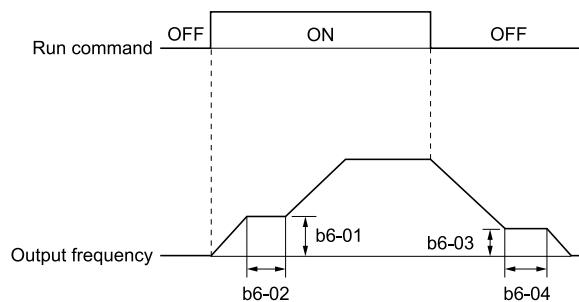


Figure 11.41 Time Chart for the Dwell Function at Start/Stop

■ **b6-01: Dwell Reference at Start**

No. (Hex.)	Name	Description	Default (Range)
b6-01 (01B6)	Dwell Reference at Start	<b>V/f</b> <b>CL-V/f</b> <b>OLV</b> <b>CLV</b> <b>AOLV</b> <b>OLV/PM</b> <b>AOLV/PM</b> <b>CLV/PM</b> <b>EZOLV</b> Sets the output frequency that the drive will hold momentarily when the motor starts.	0.0 (Determined by A1-02)

When the drive accelerates to the output frequency set in  $b6-01$ , it holds that frequency for the time set in  $b6-02$  [Dwell Time at Start], and starts to accelerate again.

### ■ b6-02: Dwell Time at Start

No. (Hex.)	Name	Description	Default (Range)
b6-02 (01B7)	Dwell Time at Start	<b>V/f</b> <b>CL-V/f</b> <b>OLV</b> <b>CLV</b> <b>AOLV</b> <b>OLV/PM</b> <b>AOLV/PM</b> <b>CLV/PM</b> <b>EZOLV</b> Sets the length of time that the drive will hold the output frequency when the motor starts.	0.0 s (0.0 - 10.0 s)

### ■ b6-03: Dwell Reference at Stop

No. (Hex.)	Name	Description	Default (Range)
b6-03 (01B8)	Dwell Reference at Stop	<b>V/f</b> <b>CL-V/f</b> <b>OLV</b> <b>CLV</b> <b>AOLV</b> <b>OLV/PM</b> <b>AOLV/PM</b> <b>CLV/PM</b> <b>EZOLV</b> Sets the output frequency that the drive will hold momentarily when ramping to stop the motor.	0.0 (Determined by A1-02)

When the drive decelerates to the output frequency set in *b6-03*, it holds that frequency for the time set in *b6-04* [Dwell Time at Stop] and starts to decelerate again.

### ■ b6-04: Dwell Time at Stop

No. (Hex.)	Name	Description	Default (Range)
b6-04 (01B9)	Dwell Time at Stop	<b>V/f</b> <b>CL-V/f</b> <b>OLV</b> <b>CLV</b> <b>AOLV</b> <b>OLV/PM</b> <b>AOLV/PM</b> <b>CLV/PM</b> <b>EZOLV</b> Sets the length of time for the drive to hold the output frequency when ramping to stop the motor.	0.0 s (0.0 - 10.0 s)

## ◆ b7: Droop Control

Droop control automatically balances the load level between two motors that operate the same load.

Droop control decreases motor speed as the load changes. You must enable the Droop control function for each motor it is operating.

To decrease motor speed, the Droop control function decreases the speed reference when an increase in the load increases the torque reference. To increase motor speed, the Droop control function increases the speed reference when a decrease in the load decreases the torque reference. The Droop control function adjusts motor speed as the torque reference changes to balance the load between the motors.

#### Note:

When you use Droop control, set  $n5-01 = 0$  [Feed Forward Control Selection = Disabled].

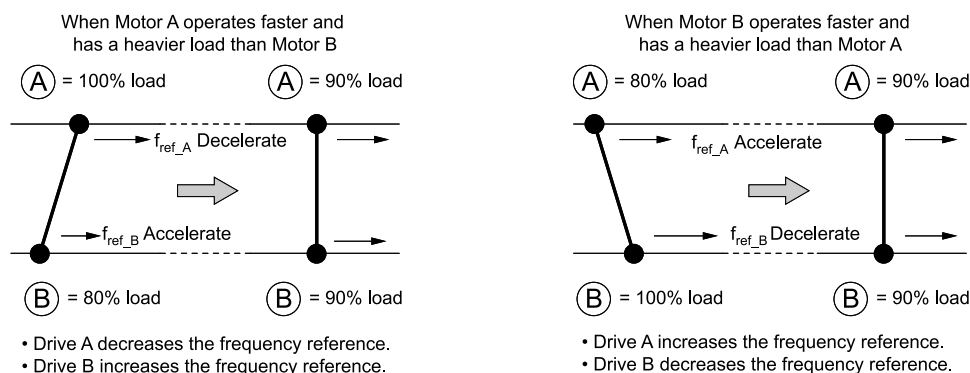


Figure 11.42 Droop Control Application

### ■ b7-01: Droop Control Gain

No. (Hex.)	Name	Description	Default (Range)
b7-01 (01CA) RUN	Droop Control Gain	<b>V/f</b> <b>CL-V/f</b> <b>OLV</b> <b>CLV</b> <b>AOLV</b> <b>OLV/PM</b> <b>AOLV/PM</b> <b>CLV/PM</b> <b>EZOLV</b> Sets the amount of deceleration when the torque reference is at 100% of Maximum Output Frequency.	0.0% (0.0 - 100.0%)

To disable Droop control, set this parameter to 0.0%.

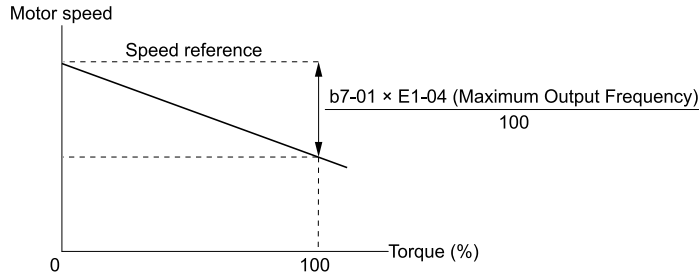


Figure 11.43 Droop Control Gain

■ **b7-02: Droop Control Delay Time**

No. (Hex.)	Name	Description	Default (Range)
b7-02 (01CB) RUN	Droop Control Delay Time	<div style="display: flex; justify-content: space-between; font-size: small;"> <span>V/f</span> <span>CL-V/f</span> <span>OLV</span> <span style="background-color: black; color: white;">CLV</span> <span style="background-color: black; color: white;">AOLV</span> <span>OLV/PM</span> <span>AOLV/PM</span> <span style="background-color: black; color: white;">CLV/PM</span> <span>EZOLV</span> </div> Sets the responsiveness of Droop control. Decrease this setting when drive response is slow. Increase this setting when hunting or oscillation occur.	0.05 s (0.03 - 2.00 s)

■ **b7-03: Droop Control Limit Selection**

No. (Hex.)	Name	Description	Default (Range)
b7-03 (017E)	Droop Control Limit Selection	<div style="display: flex; justify-content: space-between; font-size: small;"> <span>V/f</span> <span>CL-V/f</span> <span>OLV</span> <span style="background-color: black; color: white;">CLV</span> <span style="background-color: black; color: white;">AOLV</span> <span>OLV/PM</span> <span>AOLV/PM</span> <span style="background-color: black; color: white;">CLV/PM</span> <span>EZOLV</span> </div> Sets the Droop control limit function.	1 (0, 1)

0 : Disabled

1 : Enabled

◆ **b8: Energy Saving**

Energy-saving control improves overall system operating efficiency by operating the motor at its most efficient level.

Set *b8-01* and the following parameters according to the control mode and the motor.

- Set parameters *b8-04*, *b8-05*, and *b8-06* when using V/f Control or Closed Loop V/f Control.
- Set parameters *b8-02*, *b8-03* when using vector control with an induction motor.
- Set parameters *b8-16*, *b8-17* when using a PM motor.

**Note:**

- Energy-saving control is not appropriate for applications with sudden changes in the load, or applications driving heavy loads such as a traverse car application.
- Energy-saving control maximizes operation based on precise motor data set to the drive. Be sure to perform Auto-Tuning and enter the correct information about the motor before using the Energy-saving control.

■ **b8-01: Energy Saving Control Selection**

No. (Hex.)	Name	Description	Default (Range)
b8-01 (01CC)	Energy Saving Control Selection	<div style="display: flex; justify-content: space-between; font-size: small;"> <span>V/f</span> <span>CL-V/f</span> <span>OLV</span> <span style="background-color: black; color: white;">CLV</span> <span style="background-color: black; color: white;">AOLV</span> <span>OLV/PM</span> <span>AOLV/PM</span> <span style="background-color: black; color: white;">CLV/PM</span> <span>EZOLV</span> </div> Sets the Energy-saving control function.	0 (Determined by A1-02)

0 : Disabled

1 : Enabled

2 : Automatic Optimization

### ■ b8-02: Energy Saving Gain

No. (Hex.)	Name	Description	Default (Range)
b8-02 (01CD) RUN Expert	Energy Saving Gain	<input type="checkbox"/> V/f <input type="checkbox"/> CL-V/f <input checked="" type="checkbox"/> OLV <input checked="" type="checkbox"/> CLV <input type="checkbox"/> AOLV <input type="checkbox"/> OLV/PM <input type="checkbox"/> AOLV/PM <input type="checkbox"/> CLV/PM <input type="checkbox"/> EZOLV Sets the gain for Energy-saving control.	Determined by A1-02 (0.0 - 10.0)

Increase the setting value to increase energy saving. If the setting value is too large, the motor will stall.

### ■ b8-03: Energy Saving Filter Time

No. (Hex.)	Name	Description	Default (Range)
b8-03 (01CE) RUN Expert	Energy Saving Filter Time	<input type="checkbox"/> V/f <input type="checkbox"/> CL-V/f <input checked="" type="checkbox"/> OLV <input checked="" type="checkbox"/> CLV <input type="checkbox"/> AOLV <input type="checkbox"/> OLV/PM <input type="checkbox"/> AOLV/PM <input type="checkbox"/> CLV/PM <input type="checkbox"/> EZOLV Sets the responsiveness for Energy-saving control.	Determined by A1-02, C6-01, and o2-04 (0.00 - 10.00 s)

Decrease the setting value to increase responsiveness. If the setting value is too low, operation will not be stable.

### ■ b8-04: Energy Saving Coefficient Value

No. (Hex.)	Name	Description	Default (Range)
b8-04 (01CF) Expert	Energy Saving Coefficient Value	<input checked="" type="checkbox"/> V/f <input type="checkbox"/> CL-V/f <input type="checkbox"/> OLV <input type="checkbox"/> CLV <input type="checkbox"/> AOLV <input type="checkbox"/> OLV/PM <input type="checkbox"/> AOLV/PM <input type="checkbox"/> CLV/PM <input type="checkbox"/> EZOLV Sets the Energy-saving control coefficient to maintain maximum motor efficiency. The default setting is for Yaskawa motors.	Determined by C6-01, E2-11, o2-04 (0.00 - 655.00)

When you use a motor from a different manufacturer, increase the setting value in 5% increments to find the minimum value for *U1-08 [Output Power]* at light loads.

When you decrease the setting value, it decreases the output voltage and decreases power consumption. If the setting value is too low, the motor will stall.

**Note:**

When you do Rotational Auto-Tuning, the drive will automatically set the energy-saving coefficient.

### ■ b8-05: Power Detection Filter Time

No. (Hex.)	Name	Description	Default (Range)
b8-05 (01D0) Expert	Power Detection Filter Time	<input checked="" type="checkbox"/> V/f <input checked="" type="checkbox"/> CL-V/f <input type="checkbox"/> OLV <input type="checkbox"/> CLV <input type="checkbox"/> AOLV <input type="checkbox"/> OLV/PM <input type="checkbox"/> AOLV/PM <input type="checkbox"/> CLV/PM <input type="checkbox"/> EZOLV Sets the time constant to measure output power.	20 ms (0 - 2000 ms)

Decrease the setting value to increase responsiveness to load changes. If you set the value too low during operation at light loads, motor speed is not stable.

### ■ b8-06: Search Operation Voltage Limit

No. (Hex.)	Name	Description	Default (Range)
b8-06 (01D1) Expert	Search Operation Voltage Limit	<input checked="" type="checkbox"/> V/f <input checked="" type="checkbox"/> CL-V/f <input type="checkbox"/> OLV <input type="checkbox"/> CLV <input type="checkbox"/> AOLV <input type="checkbox"/> OLV/PM <input type="checkbox"/> AOLV/PM <input type="checkbox"/> CLV/PM <input type="checkbox"/> EZOLV Sets the voltage limit for Search Operation as a percentage where motor rated voltage is a setting value of 100%.	0% (0 - 100%)

The Search Operation changes the output voltage in small increments to find a setpoint at which the drive can use minimum power to operate.

Set this parameter to 0 to disable Search Operation. This will not disable Energy-saving control.

If the setting value is too low, the motor will stall when loads suddenly increase.

■ **b8-16: PM E-Save Coefficient Ki**

No. (Hex.)	Name	Description	Default (Range)
b8-16 (01F8) Expert	PM E-Save Coefficient Ki	<span>V/f</span> <span>CL-V/f</span> <span>OLV</span> <span>CLV</span> <span>AOLV</span> <span>OLV/PM</span> <span>AOLV/PM</span> <span>CLV/PM</span> <span>EZOLV</span> Sets torque linearity. This parameter uses the Ki value from the motor nameplate. Usually it is not necessary to change this setting.	1.00 (0.00 - 3.00)

When  $b8-16 = 1.00$  (default), the drive will automatically calculate and control the energy-saving coefficient. If the motor nameplate has a description for "Ki", set this parameter to the Ki value.

Do this procedure to prevent oscillation when you set  $b8-01 = 1$  [Energy Saving Control Selection = Enabled].

1. Check U5-21 [Energy Save Coeff Ki] and make sure that it aligns with the Ki value on the motor nameplate.
2. If the numbers are different, set  $b8-16$  to the Ki value on the motor nameplate.

■ **b8-17: PM E-Save Coefficient Kt**

No. (Hex.)	Name	Description	Default (Range)
b8-17 (01F9) Expert	PM E-Save Coefficient Kt	<span>V/f</span> <span>CL-V/f</span> <span>OLV</span> <span>CLV</span> <span>AOLV</span> <span>OLV/PM</span> <span>AOLV/PM</span> <span>CLV/PM</span> <span>EZOLV</span> Sets torque linearity. This parameter uses the Kt value from the motor nameplate. Usually it is not necessary to change this setting.	1.00 (0.00 - 3.00)

When  $E5-01 = 1xxx, 2xxx$  [PM Motor Code Selection = Yaskawa SSR1 or SST4 series IPM motor], the drive automatically calculates the energy-saving coefficient Kt and uses that value to control operation.

Do this procedure to prevent oscillation when you set  $b8-01 = 1$  [Energy Saving Control Selection = Enabled].

1. Check U5-22 [Energy Save Coeff Kt] and make sure that it aligns with the Kt value on the motor nameplate.
2. If the numbers are different, set  $b8-17$  to the Kt value on the motor nameplate.

■ **b8-18: E-Save d-axis Current FilterTime**

No. (Hex.)	Name	Description	Default (Range)
b8-18 (01FA) Expert	E-Save d-axis Current FilterTime	<span>V/f</span> <span>CL-V/f</span> <span>OLV</span> <span>CLV</span> <span>AOLV</span> <span>OLV/PM</span> <span>AOLV/PM</span> <span>CLV/PM</span> <span>EZOLV</span> Sets the d-axis current reference filter time constant.	0.100 s (0.000 - 5.000 s)

■ **b8-19: E-Save Search Injection Freq**

No. (Hex.)	Name	Description	Default (Range)
b8-19 (0B40) Expert	E-Save Search Injection Freq	<span>V/f</span> <span>CL-V/f</span> <span>OLV</span> <span>CLV</span> <span>AOLV</span> <span>OLV/PM</span> <span>AOLV/PM</span> <span>CLV/PM</span> <span>EZOLV</span> Sets the frequency of Energy-saving control search operations. Usually it is not necessary to change this setting.	Determined by A1-02 (20 - 300 Hz)

**Note:**

- If low inertia causes vibration in the machine, increase the setting value in 10 Hz increments and check the response. If  $A1-02 = 8$  [Control Method Selection = EZ Vector Control], increase the setting value in 1 Hz increments.
- To make the motor more efficient, decrease the setting value in 1 Hz increments until the point immediately before machine vibration starts to occur.

■ **b8-20: E-Save Search Width**

No. (Hex.)	Name	Description	Default (Range)
b8-20 (0B41) Expert	E-Save Search Width	<span>V/f</span> <span>CL-V/f</span> <span>OLV</span> <span>CLV</span> <span>AOLV</span> <span>OLV/PM</span> <span>AOLV/PM</span> <span>CLV/PM</span> <span>EZOLV</span> Sets the amplitude of Energy-saving control search operations.	1.0 degrees (0.1 - 5.0 degrees)

An increase in the value can make the operational efficiency better. However, if the load inertia is small, it may be necessary to adjust the value to prevent machine vibration.



**Note:**

- If low inertia causes vibration in the machine, decrease the setting value in 1.0-degree increments and check the response.
- To make the motor more efficient, increase the setting value in 1.0-degree increments until the point immediately before machine vibration starts to occur.

**■ b8-21: PM E-Save Search Gain**

No. (Hex.)	Name	Description	Default (Range)
b8-21 (0B42) Expert	PM E-Save Search Gain	V/f CL-V/f OLV CLV AOLV OLV/PM AOLV/PM CLV/PM EZOLV Sets the gain of Energy-saving control search operations.	0.3Hz (0.1 - 20.0 Hz)

When you decrease the value of *C5-01 [ASR Proportional Gain 1]*, also decrease the value of *b8-21* to keep the correct ratio.

**■ b8-22: PM E-Save Search LPF Cutoff Freq**

No. (Hex.)	Name	Description	Default (Range)
b8-22 (0B43) Expert	PM E-Save Search LPF Cutoff Freq	V/f CL-V/f OLV CLV AOLV OLV/PM AOLV/PM CLV/PM EZOLV Sets the frequency of the filter used to extract the high-efficiency phase from search operations. Usually it is not necessary to change this setting.	10.0 Hz (1.0 - 30.0 Hz)

**■ b8-23: PM E-Save Search Limit**

No. (Hex.)	Name	Description	Default (Range)
b8-23 (0B44) Expert	PM E-Save Search Limit	V/f CL-V/f OLV CLV AOLV OLV/PM AOLV/PM CLV/PM EZOLV Sets the search operations output limit. Usually it is not necessary to change this setting.	15.0 degrees (0.0 - 30.0 degrees)

When the motor characteristics are correct, increase this value to make the motor more efficient.

**■ b8-24: PM E-Save High Freq ACR Gain**

No. (Hex.)	Name	Description	Default (Range)
b8-24 (0B45) Expert	PM E-Save High Freq ACR Gain	V/f CL-V/f OLV CLV AOLV OLV/PM AOLV/PM CLV/PM EZOLV Sets the gain for high-frequency current control.	200.0 Hz (100.0 - 1000.0 Hz)

**Note:**

If the drive detects *oC [Overcurrent]*, decrease the value.

**■ b8-25: PM E-Save Search Start Level**

No. (Hex.)	Name	Description	Default (Range)
b8-25 (0B46) Expert	PM E-Save Search Start Level	V/f CL-V/f OLV CLV AOLV OLV/PM AOLV/PM CLV/PM EZOLV Sets the start level for search operations.	10.0% (0.0 - 100.0%)

**Note:**

If there is vibration in the machine, increase the value.

**■ b8-26: PM E-Save Power Setpoint**

No. (Hex.)	Name	Description	Default (Range)
b8-26 (0B47) Expert	PM E-Save Power Setpoint	V/f CL-V/f OLV CLV AOLV OLV/PM AOLV/PM CLV/PM EZOLV Sets a value to increase torque accuracy.	0.0% (-10.0 - +10.0%)

■ **b8-28: Over Excitation Action Selection**

No. (Hex.)	Name	Description	Default (Range)
b8-28 (0B8B) Expert	Over Excitation Action Selection	V/f CL-V/f OLV CLV AOLV OLV/PM AOLV/PM CLV/PM <b>EZOLV</b> Sets the function for excitation operation.	0 (0, 1)

When operation is not stable at low speeds, set this parameter to 1 to enable the function.

**0 : Disabled**

**1 : Enabled**

■ **b8-29: Energy Saving Priority Selection**

No. (Hex.)	Name	Description	Default (Range)
b8-29 (0B8C)	Energy Saving Priority Selection	V/f CL-V/f OLV CLV AOLV OLV/PM AOLV/PM CLV/PM <b>EZOLV</b> Sets the priority of drive response between changes to the load or Energy-saving control.	0 (0, 1)

Enable this parameter when there are small changes in the load. It is possible that the motor cannot respond correctly to changes in the load.

**0 : Priority: Drive Response**

**1 : Priority: Energy Savings**

■ **b8-50: Standby Mode Selection**

No. (Hex.)	Name	Description	Default (Range)
b8-50 (0B0D)	Standby Mode Selection	V/f CL-V/f OLV CLV AOLV OLV/PM AOLV/PM CLV/PM <b>EZOLV</b> Sets the Standby Mode function.	0 (0, 1)

**0 : Disabled**

**1 : Enabled**

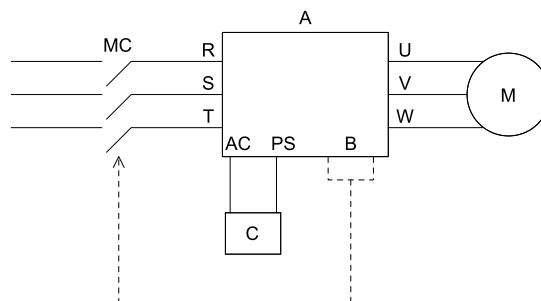
Standby Mode decreases how much power the drive consumes when it is in standby.

Standby Mode waits for the drive to stop, then uses the relay output of an MFDO terminal to shut off the input side electromagnetic contactor (MC) and then shut off the main circuit power supply.

**Note:**

These conditions are also necessary for Standby Mode:

- Connect an external 24 V power supply.
- Connect a electromagnetic contactor to the drive input side and connect the MFDO terminal set for  $H2-xx = 65$  [Standby Output]. When the MFDO terminal is OFF, the electromagnetic contactor must be OFF.
- Frequently starting and stopping the drive and regularly opening and closing the electromagnetic contactor will decrease the service life of the drive.



**A - Drive**

**B - MFDO Terminal**

**C - External 24 V power supply**

## ■ b8-51: Standby Mode Wait Time

No. (Hex.)	Name	Description	Default (Range)
b8-51 (0B01)	Standby Mode Wait Time	<div style="display: flex; justify-content: space-between; font-size: small;"> <span>V/f</span> <span>CL-V/f</span> <span>OLV</span> <span>CLV</span> <span>AOLV</span> <span>OLV/PM</span> <span>AOLV/PM</span> <span>CLV/PM</span> <span>EZOLV</span> </div> Sets the delay time before turning off the electromagnetic contactor after the drive stops.	600 s (0 - 6000 s)

## ◆ b9: Zero Servo

Zero Servo is a position control function that stops and holds the motor shaft. The drive safeties the stopped motor and an external force will not move the motor.

When you enable the Zero Servo function, the drive will save the home position. The drive can correct the motor position and put the motor into the home position when the load rotates the motor.

To enable Zero Servo, set  $H1-xx = 72$  [MFDI Function Select = Zero Servo]. The drive starts Zero Servo when the MFDI terminal set for Zero Servo [ $H1-xx = 72$ ] activates and the motor speed decreases to less than the value set in  $b2-01$  [DC Injection/Zero SpeedThreshold]. The drive stops and holds the motor in the Zero Servo start position. When Zero Servo is enabled, the drive will hold the motor in position when the frequency reference increases to more than the value set in  $b2-01$ . The drive accelerates to the frequency reference when the MFDI terminal set to trigger the Zero Servo function is released and there is a Run command.

### Note:

Zero Servo is available when  $A1-02 = 3, 7$  [Control Method Selection = Closed Loop Vector, PM Closed Loop Vector].

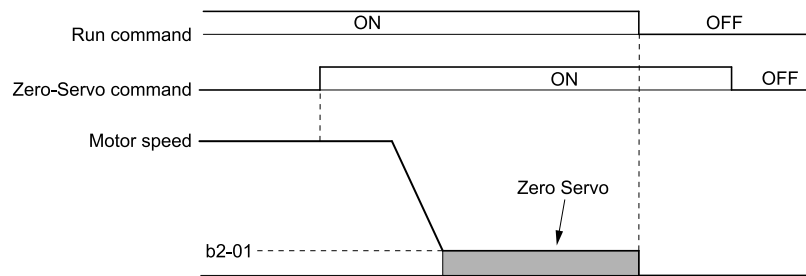


Figure 11.44 Zero Servo Time Chart

Monitor  $U6-22$  [ZeroServo Pulse Move] shows the difference between the position of the motor shaft and the Zero Servo start position when Zero Servo is enabled. To find the difference, divide the number of pulses shown in  $U6-22$  by 4.

When the position of the motor shaft is in the range of “Zero Servo start position  $\pm b9-02$  [Zero Servo Completion Window]”, the drive will activate the MFDO set for Zero Servo Complete [ $H2-xx = 33$ ].

**NOTICE:** Do not let the Zero Servo function hold 100% load for long periods of time. When the application must use Zero Servo to hold 100% load for long periods, operate in less than 50% of the drive rated output current or use a larger capacity drive. Failure to obey will cause damage to the drive.

### Note:

- When you use the Zero Servo function, keep the Run command ON. If the Run command is OFF, the drive will not hold the motor shaft in position.
- When you turn OFF the Zero-Servo command, the terminal set for Zero Servo Complete will deactivate.
- If  $A1-02 = 7$  [PM Closed Loop Vector] and an external force rotates the motor during Zero Servo, the drive will detect  $dv4$  [Inversion Prevention Detection]. To prevent  $dv4$  detection, increase  $b9-01$  [Zero Servo Gain] or increase the number of pulses set in  $F1-19$  [Deviation 4 Detection Selection].

## ■ b9-01: Zero Servo Gain

No. (Hex.)	Name	Description	Default (Range)
b9-01 (01DA)	Zero Servo Gain	<div style="display: flex; justify-content: space-between; font-size: small;"> <span>V/f</span> <span>CL-V/f</span> <span>OLV</span> <span>CLV</span> <span>AOLV</span> <span>OLV/PM</span> <span>AOLV/PM</span> <span>CLV/PM</span> <span>EZOLV</span> </div> Sets the responsiveness for the Zero Servo function.	5 (0 - 100)

If the drive is not responsive, or if there is too much deviation from the Zero Servo start point when you increase the load, increase this setting. If oscillation or hunting occurs, decrease this setting.

### Note:

- Set  $C5-xx$  [Automatic Speed Regulator (ASR)] parameters correctly before you adjust the Zero Servo gain.
- When you operate with the Zero Servo command enabled, oscillation and hunting must not occur.

### ■ b9-02: Zero Servo Completion Window

No. (Hex.)	Name	Description	Default (Range)
b9-02 (01DB)	Zero Servo Completion Window	<div style="display: flex; justify-content: space-between; font-size: small; margin-bottom: 5px;"> <span>V/f</span> <span>CL-V/f</span> <span>OLV</span> <span style="background-color: #333; color: white; padding: 2px;">CLV</span> <span>AOLV</span> <span>OLV/PM</span> <span>AOLV/PM</span> <span style="background-color: #333; color: white; padding: 2px;">CLV/PM</span> <span>EZOLV</span> </div> Sets the range to trigger an output terminal set for “Zero Servo Complete” during Zero Servo operation. Be sure to set the deviation from the Zero Servo start position.	10 (0 - 16383)

When the position of the motor shaft is in the range of “Zero Servo start position  $\pm$  b9-02”, the drive will activate a MFDO set for *Zero Servo Complete* [ $H2-xx = 33$ ].

## 11.4 C: Tuning

*C* parameters adjust drive operation, including:

- Acceleration Time
- Deceleration Time
- Slip Compensation
- Torque Compensation
- Carrier Frequency

### ◆ C1: Accel & Decel Time

You can set four different acceleration and deceleration time pairs in the drive. When you activate and deactivate  $H1-xx = 7, 16, 1A$  [MFDI Function Select = Accel/Decel Time Selection 1, Motor 2 Selection, Accel/Decel Time Selection 2], you can switch acceleration and deceleration times during run.

Acceleration time parameters always set the time to accelerate from 0 Hz to  $E1-04$  [Maximum Output Frequency]. Deceleration time parameters always set the time to decelerate from  $E1-04$  to 0 Hz.

$C1-01$  [Acceleration Time 1] and  $C1-02$  [Deceleration Time 1] are the default active accel/decel settings.

Parameters	Setting Range
$C1-01$ [Acceleration Time 1]	0.0 to 6000.0 s
$C1-02$ [Deceleration Time 1]	
$C1-03$ [Acceleration Time 2]	
$C1-04$ [Deceleration Time 2]	
$C1-05$ [Acceleration Time 3]	
$C1-06$ [Deceleration Time 3]	
$C1-07$ [Acceleration Time 4]	
$C1-08$ [Deceleration Time 4]	

**Note:**

When  $C1-10 = 0$  [Accel/Decel Time Setting Units = 0.01 s (0.00 to 600.00 s)], the setting range for acceleration and deceleration times is 0.00 s to 600.00 s.

### ■ Use MFDIs to Switch Acceleration Times

Select the different acceleration and deceleration times as shown in [Table 11.34](#).

**Table 11.34 Accel/Decel Times and Active Parameters**

$H1-xx = 7$ [Accel/Decel Time Selection 1]	$H1-xx = 1A$ [Accel/Decel Time Selection 2]	Active Parameter	
		Acceleration Time	Deceleration Time
OFF	OFF	$C1-01$ [Acceleration Time 1]	$C1-02$ [Deceleration Time 1]
ON	OFF	$C1-03$ [Acceleration Time 2]	$C1-04$ [Deceleration Time 2]
OFF	ON	$C1-05$ [Acceleration Time 3]	$C1-06$ [Deceleration Time 3]
ON	ON	$C1-07$ [Acceleration Time 4]	$C1-08$ [Deceleration Time 4]

[Figure 11.45](#) shows an operation example to change acceleration and deceleration times. It is necessary to set  $b1-03 = 0$  [Stopping Method Selection = Ramp to Stop] for this example.

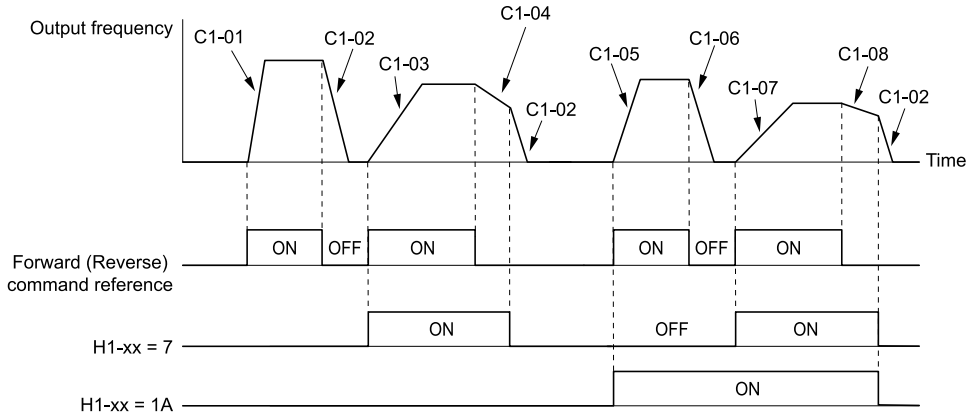


Figure 11.45 Timing Diagram of Acceleration and Deceleration Times

■ Use Motor Selection to Switch Acceleration and Deceleration Times

When you set  $H1-xx = 16$  [MFDI Function Select = Motor 2 Selection], you can activate and deactivate the input terminal to switch between motor 1 and motor 2.

Note:

You cannot use the Motor 2 Selection function with PM motors.

Table 11.35 shows the possible acceleration and deceleration time combinations when you use the Motor 2 Selection function.

Table 11.35 Motor Selection and Acceleration and Deceleration Times

H1-xx = 7 [Accel/Decel Time Selection 1]	H1-xx = 16 [Motor 2 Selection]			
	Motor 2 Selection: OFF		Motor 2 Selection: ON	
	Acceleration Time	Deceleration Time	Acceleration Time	Deceleration Time
OFF	C1-01	C1-02	C1-05	C1-06
ON	C1-03	C1-04	C1-07	C1-08

■ Use Output Frequency Level to Switch Acceleration and Deceleration Times

The drive can use output frequency to automatically switch between different acceleration and deceleration times. The acceleration and deceleration times for the drive are switched automatically. When the output frequency =  $C1-11$  [Accel/Decel Time Switchover Freq], the drive automatically switches the acceleration and deceleration times. Set  $C1-11 = 0.0$  Hz to disable this function.

Note:

- Acceleration and deceleration times set to MFDIs are more important than the automatic switch using the frequency level set in  $C1-11$ . For example, if the MFDI set for *Accel/Decel Time Selection 1* [ $H1-xx = 7$ ] is activated, the drive will use only accel/decel time 2 (or accel/decel time 4 for motor 2). If you use a frequency level set in  $C1-11$ , the drive will not automatically switch acceleration and deceleration times.
- If Motor 2 Selection [ $H1-xx = 16$ ] is activated, the drive will set the acceleration/deceleration time to  $C1-05$  and  $C1-06$  for motor 2 when the output frequency is more than the frequency level set in  $C1-11$ .

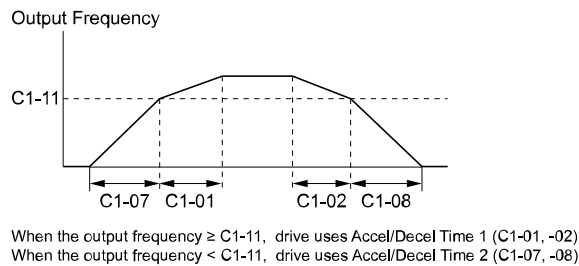


Figure 11.46 Accel/Decel Time Switchover Freq

### ■ C1-01: Acceleration Time 1

No. (Hex.)	Name	Description	Default (Range)
C1-01 (0200) RUN	Acceleration Time 1	<b>V/f</b> <b>CL-V/f</b> <b>OLV</b> <b>CLV</b> <b>AOLV</b> <b>OLV/PM</b> <b>AOLV/PM</b> <b>CLV/PM</b> <b>EZOLV</b> Sets the length of time to accelerate from zero to maximum output frequency.	10.0 s (0.0 - 6000.0 s)

**Note:**

When  $C1-10 = 0$  [Accel/Decel Time Setting Units = 0.01 s (0.00 to 600.00 s)], the setting range is 0.00 to 600.00 s.

### ■ C1-02: Deceleration Time 1

No. (Hex.)	Name	Description	Default (Range)
C1-02 (0201) RUN	Deceleration Time 1	<b>V/f</b> <b>CL-V/f</b> <b>OLV</b> <b>CLV</b> <b>AOLV</b> <b>OLV/PM</b> <b>AOLV/PM</b> <b>CLV/PM</b> <b>EZOLV</b> Sets the length of time to decelerate from maximum output frequency to zero.	10.0 s (0.0 - 6000.0 s)

**Note:**

When  $C1-10 = 0$  [Accel/Decel Time Setting Units = 0.01 s (0.00 to 600.00 s)], the setting range is 0.00 to 600.00 s.

### ■ C1-03: Acceleration Time 2

No. (Hex.)	Name	Description	Default (Range)
C1-03 (0202) RUN	Acceleration Time 2	<b>V/f</b> <b>CL-V/f</b> <b>OLV</b> <b>CLV</b> <b>AOLV</b> <b>OLV/PM</b> <b>AOLV/PM</b> <b>CLV/PM</b> <b>EZOLV</b> Sets the length of time to accelerate from zero to maximum output frequency.	10.0 s (0.0 - 6000.0 s)

**Note:**

When  $C1-10 = 0$  [Accel/Decel Time Setting Units = 0.01 s (0.00 to 600.00 s)], the setting range is 0.00 to 600.00 s.

### ■ C1-04: Deceleration Time 2

No. (Hex.)	Name	Description	Default (Range)
C1-04 (0203) RUN	Deceleration Time 2	<b>V/f</b> <b>CL-V/f</b> <b>OLV</b> <b>CLV</b> <b>AOLV</b> <b>OLV/PM</b> <b>AOLV/PM</b> <b>CLV/PM</b> <b>EZOLV</b> Sets the length of time to decelerate from maximum output frequency to zero.	10.0 s (0.0 - 6000.0 s)

**Note:**

When  $C1-10 = 0$  [Accel/Decel Time Setting Units = 0.01 s (0.00 to 600.00 s)], the setting range is 0.00 to 600.00 s.

### ■ C1-05: Acceleration Time 3

No. (Hex.)	Name	Description	Default (Range)
C1-05 (0204) RUN	Acceleration Time 3	<b>V/f</b> <b>CL-V/f</b> <b>OLV</b> <b>CLV</b> <b>AOLV</b> <b>OLV/PM</b> <b>AOLV/PM</b> <b>CLV/PM</b> <b>EZOLV</b> Sets the length of time to accelerate from zero to maximum output frequency.	10.0 s (0.0 - 6000.0 s)

**Note:**

When  $C1-10 = 0$  [Accel/Decel Time Setting Units = 0.01 s (0.00 to 600.00 s)], the setting range is 0.00 to 600.00 s.

### ■ C1-06: Deceleration Time 3

No. (Hex.)	Name	Description	Default (Range)
C1-06 (0205) RUN	Deceleration Time 3	<b>V/f</b> <b>CL-V/f</b> <b>OLV</b> <b>CLV</b> <b>AOLV</b> <b>OLV/PM</b> <b>AOLV/PM</b> <b>CLV/PM</b> <b>EZOLV</b> Sets the length of time to decelerate from maximum output frequency to zero.	10.0 s (0.0 - 6000.0 s)

**Note:**

When  $C1-10 = 0$  [Accel/Decel Time Setting Units = 0.01 s (0.00 to 600.00 s)], the setting range is 0.00 to 600.00 s.

■ **C1-07: Acceleration Time 4**

No. (Hex.)	Name	Description	Default (Range)
C1-07 (0206) RUN	Acceleration Time 4	<div style="display: flex; justify-content: space-between; font-size: 0.8em; font-weight: bold;"> <span>V/f</span> <span>CL-V/f</span> <span>OLV</span> <span>CLV</span> <span>AOLV</span> <span>OLV/PM</span> <span>AOLV/PM</span> <span>CLV/PM</span> <span>EZOLV</span> </div> Sets the length of time to accelerate from zero to maximum output frequency.	10.0 s (0.0 - 6000.0 s)

**Note:**

When  $C1-10 = 0$  [Accel/Decel Time Setting Units = 0.01 s (0.00 to 600.00 s)], the setting range is 0.00 to 600.00 s.

■ **C1-08: Deceleration Time 4**

No. (Hex.)	Name	Description	Default (Range)
C1-08 (0207) RUN	Deceleration Time 4	<div style="display: flex; justify-content: space-between; font-size: 0.8em; font-weight: bold;"> <span>V/f</span> <span>CL-V/f</span> <span>OLV</span> <span>CLV</span> <span>AOLV</span> <span>OLV/PM</span> <span>AOLV/PM</span> <span>CLV/PM</span> <span>EZOLV</span> </div> Sets the length of time to decelerate from maximum output frequency to zero.	10.0 s (0.0 - 6000.0 s)

**Note:**

When  $C1-10 = 0$  [Accel/Decel Time Setting Units = 0.01 s (0.00 to 600.00 s)], the setting range is 0.00 to 600.00 s.

■ **C1-09: Fast Stop Time**

No. (Hex.)	Name	Description	Default (Range)
C1-09 (0208)	Fast Stop Time	<div style="display: flex; justify-content: space-between; font-size: 0.8em; font-weight: bold;"> <span>V/f</span> <span>CL-V/f</span> <span>OLV</span> <span>CLV</span> <span>AOLV</span> <span>OLV/PM</span> <span>AOLV/PM</span> <span>CLV/PM</span> <span>EZOLV</span> </div> Sets the length of time that the drive will decelerate to zero for a Fast Stop.	10.0 s (0.0 - 6000.0 s)

**Note:**

- When  $C1-10 = 0$  [Accel/Decel Time Setting Units = 0.01 s (0.00 to 600.00 s)], the setting range is 0.00 to 600.00 s.
- When  $L2-29 = 0$  [Kinetic Energy Backup Method = Single Drive KEB Ride-Thru 1] and you do KEB Auto-Tuning, the drive will automatically set  $C1-09$ . If you must not change the Fast Stop time, do not do KEB Auto-Tuning.

The Fast Stop function will be triggered in the following circumstances.

- The Fast Stop operation will be triggered by the input of the Fast Stop command via the multi-function digital input terminal.
- The Fast Stop operation is will be triggered when by the input of the Fast Stop command is input via the multi-function digital input terminal.

Set  $H1-xx = 15, 17$  [MFDI Function Select = Fast Stop (N.O.), Fast Stop (N.C.)].

When the Fast Stop command is input, the Fast Stop operation will be triggered at the deceleration time set to  $C1-09$ . The drive cannot be restarted after initiating a Fast Stop operation until deceleration is complete. Complete deceleration and cycle the Run command to clear the Fast Stop input.

The terminal set for  $H2-xx = 4C$  [MFDO Function Select = During Fast Stop] will be ON during Fast Stop.

**Note:**

Decelerating too quickly can cause an *ov* [Overvoltage] fault that shuts off the drive while the motor to coasts to a stop. Set a Fast Stop time in  $C1-09$  that prevents motor coasting and makes sure that the motor stops quickly and safely.

■ **C1-10: Accel/Decel Time Setting Units**

No. (Hex.)	Name	Description	Default (Range)
C1-10 (0209)	Accel/Decel Time Setting Units	<div style="display: flex; justify-content: space-between; font-size: 0.8em; font-weight: bold;"> <span>V/f</span> <span>CL-V/f</span> <span>OLV</span> <span>CLV</span> <span>AOLV</span> <span>OLV/PM</span> <span>AOLV/PM</span> <span>CLV/PM</span> <span>EZOLV</span> </div> Sets the setting units for $C1-01$ to $C1-08$ [Accel/Decel Times 1 to 4], $C1-09$ [Fast Stop Time], $L2-06$ [Kinetic Energy Backup Decel Time], and $L2-07$ [Kinetic Energy Backup Accel Time].	1 (0, 1)

**0 : 0.01 s (0.00 to 600.00 s)**

Sets acceleration and deceleration times in 0.01 s units. The setting range is 0.0 to 6000.0 s.

If one of these parameters is set to 1000.0 s or longer, you cannot set  $C1-10 = 0$ :



- C1-01 to C1-09
- L2-06
- L2-07

When one of those parameters is set to a value between 600.1 s and 1000.0 s, you can set  $C1-10 = 0$ , but the time will change to 600.00 s.

### 1 : 0.1 s (0.0 to 6000.0 s)

Sets acceleration and deceleration times in 0.1 s units. The setting range is 0.0 to 6000.0 s.

## ■ C1-11: Accel/Decel Time Switchover Freq

No. (Hex.)	Name	Description	Default (Range)
C1-11 (020A)	Accel/Decel Time Switchover Freq	V/f CL-V/f OLV CLV AOLV OLV/PM AOLV/PM CLV/PM EZOLV Sets the frequency at which the drive will automatically change acceleration and deceleration times.	Determined by A1-02 (0.0 - 590.0 Hz)

When output frequency get C1-11 value, the drive automatically switches the acceleration and deceleration times. Set this parameter to 0.0 to disable this function.

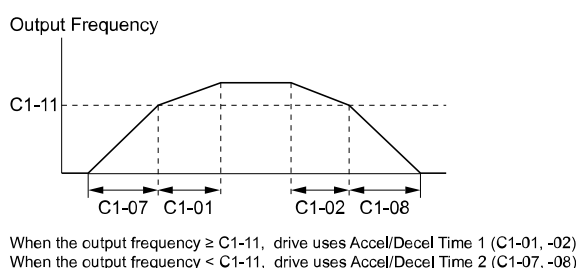


Figure 11.47 Accel/Decel Time Switching Frequency

Table 11.36 lists the possible combinations of acceleration and deceleration time switchover frequencies and the acceleration times for the Motor 2 Selection function.

Table 11.36 Motor and Acceleration and Deceleration Time Combination

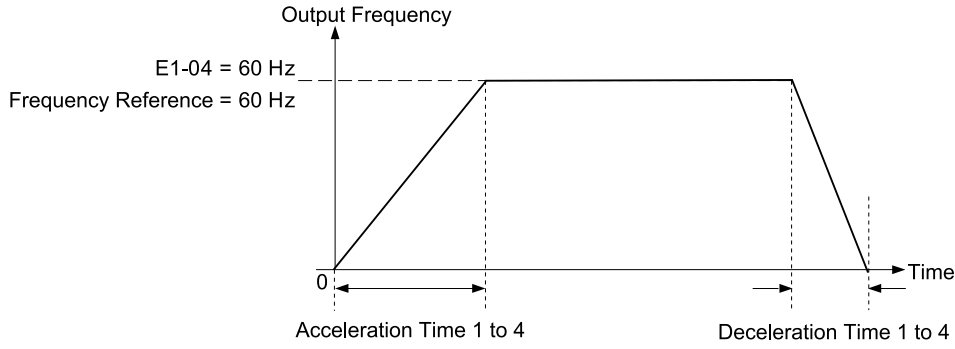
C1-11	Motor 1		Motor 2	
	Acceleration Time	Deceleration Time	Acceleration Time	Deceleration Time
Less than the setting value	C1-07 [Acceleration Time 4]	C1-08 [Deceleration Time 4]	C1-07 [Acceleration Time 4]	C1-08 [Deceleration Time 4]
Equal to or more than the setting value	C1-01 [Acceleration Time 1]	C1-02 [Deceleration Time 1]	C1-05 [Acceleration Time 3]	C1-06 [Deceleration Time 3]

## ■ C1-14: Accel/Decel Rate Frequency

No. (Hex.)	Name	Description	Default (Range)
C1-14 (0264)	Accel/Decel Rate Frequency	V/f CL-V/f OLV CLV AOLV OLV/PM AOLV/PM CLV/PM EZOLV Sets the base frequency used to calculate acceleration and deceleration rates.	0.0 Hz (0.0 - 590.0 Hz)

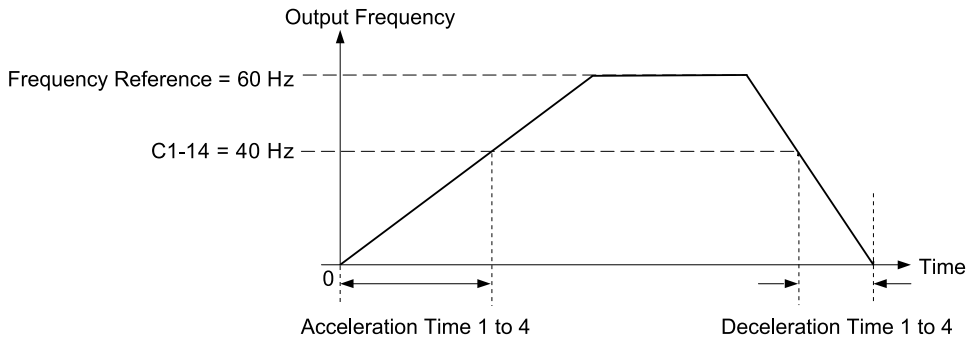
The acceleration and deceleration rates set in C1-01 to C1-09 [Acceleration/Deceleration Times 1 to 4, Fast Stop Time] will change when the value of C1-14 changes.

- When  $C1-14 = 0.0$  Hz
  - C1-01, C1-03, C1-05, C1-07 [Acceleration Times 1 to 4]: Time to accelerate from 0 Hz to E1-04 [Maximum Output Frequency]
  - C1-02, C1-04, C1-06, C1-08 [Deceleration Times 1 to 4], C1-09 [Fast Stop Time]: Time to decelerate from E1-04 to 0 Hz.

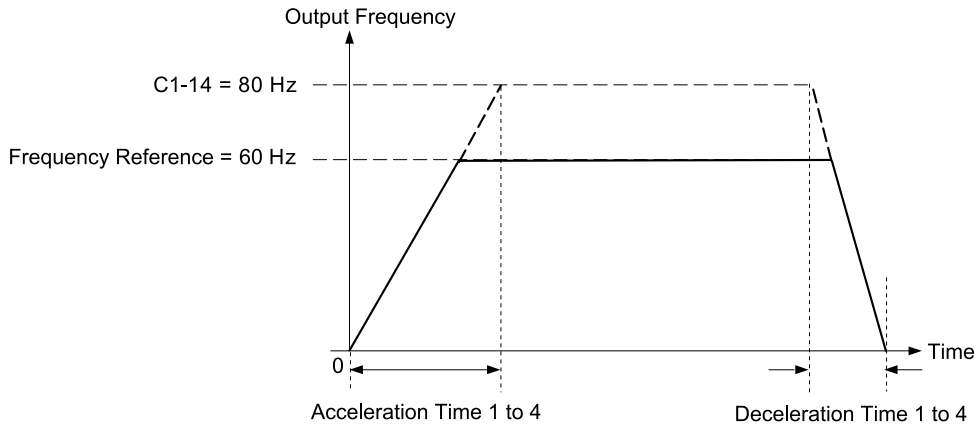


**Figure 11.48 Example 1: Acceleration/Deceleration Rate (When C1-14 = 0 Hz, E1-04 = 60 Hz, and the Frequency Reference is 60 Hz)**

- When  $C1-14 \neq 0.0$  Hz
  - C1-01, C1-03, C1-05, C1-07: Time to accelerate from 0 Hz to C1-14
  - C1-02, C1-04, C1-06, C1-08, C1-09: Time to decelerate from C1-14 to 0 Hz



**Figure 11.49 Example 2: Acceleration/Deceleration Rate (When C1-14 = 40 Hz, E1-04 = 60 Hz, and the Frequency Reference is 60 Hz)**



**Figure 11.50 Example 3: Acceleration/Deceleration Rate (When C1-14 = 80 Hz, E1-04 = 60 Hz, and the Frequency Reference is 60 Hz)**

**Note:**

- Figure 11.48 to Figure 11.50 show the accel/decel times when C2-01 to C2-04 [S-Curve Times @ Start/End of Accel/Decel] = 0.00 s.
- When L3-01  $\neq 0$  [Stall Prevention during Accel  $\neq$  Disabled], Stall Prevention could cause the acceleration time to be longer than the set value.
- When L3-04  $\neq 0$  [Stall Prevention during Decel  $\neq$  Disabled], Stall Prevention could cause the deceleration time to be longer than the set value.

◆ **C2: S-Curve Characteristics**

Use S-curve characteristics to smooth acceleration and deceleration and to minimize abrupt shock to the load. Set S-curve characteristic time during acceleration/deceleration at start and acceleration/deceleration at stop. The following figure explains how S-curves are applied.

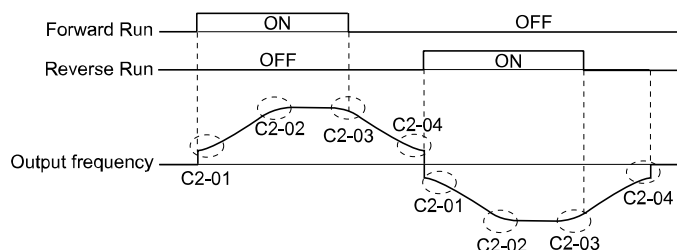


Figure 11.51 S-Curve Timing Diagram - Forward/Reverse Operation

**Note:**

- If STPo [Motor Step-Out Detected] occurs when starting a PM motor, try increasing the value set to C2-01.
- Setting the S-curve will increase the acceleration and deceleration times.

$$\text{Acceleration time} = \text{Selected acceleration time} + \frac{C2-01 + C2-02}{2}$$

$$\text{Deceleration time} = \text{Selected deceleration time} + \frac{C2-03 + C2-04}{2}$$

### ■ C2-01: S-Curve Time @ Start of Accel

No. (Hex.)	Name	Description	Default (Range)
C2-01 (020B)	S-Curve Time @ Start of Accel	<input type="checkbox"/> V/f <input type="checkbox"/> CL-V/f <input type="checkbox"/> OLV <input type="checkbox"/> CLV <input type="checkbox"/> AOLV <input type="checkbox"/> OLV/PM <input type="checkbox"/> AOLV/PM <input type="checkbox"/> CLV/PM <input type="checkbox"/> EZOLV Sets the S-curve acceleration time at start.	Determined by A1-02 (0.00 - 10.00 s)

### ■ C2-02: S-Curve Time @ End of Accel

No. (Hex.)	Name	Description	Default (Range)
C2-02 (020C)	S-Curve Time @ End of Accel	<input type="checkbox"/> V/f <input type="checkbox"/> CL-V/f <input type="checkbox"/> OLV <input type="checkbox"/> CLV <input type="checkbox"/> AOLV <input type="checkbox"/> OLV/PM <input type="checkbox"/> AOLV/PM <input type="checkbox"/> CLV/PM <input type="checkbox"/> EZOLV Sets the S-curve acceleration time at completion.	0.20 s (0.00 - 10.00 s)

### ■ C2-03: S-Curve Time @ Start of Decel

No. (Hex.)	Name	Description	Default (Range)
C2-03 (020D)	S-Curve Time @ Start of Decel	<input type="checkbox"/> V/f <input type="checkbox"/> CL-V/f <input type="checkbox"/> OLV <input type="checkbox"/> CLV <input type="checkbox"/> AOLV <input type="checkbox"/> OLV/PM <input type="checkbox"/> AOLV/PM <input type="checkbox"/> CLV/PM <input type="checkbox"/> EZOLV Sets the S-curve deceleration time at start.	0.20 s (0.00 - 10.00 s)

### ■ C2-04: S-Curve Time @ End of Decel

No. (Hex.)	Name	Description	Default (Range)
C2-04 (020E)	S-Curve Time @ End of Decel	<input type="checkbox"/> V/f <input type="checkbox"/> CL-V/f <input type="checkbox"/> OLV <input type="checkbox"/> CLV <input type="checkbox"/> AOLV <input type="checkbox"/> OLV/PM <input type="checkbox"/> AOLV/PM <input type="checkbox"/> CLV/PM <input type="checkbox"/> EZOLV Sets the S-curve deceleration time at completion.	0.00 s (0.00 - 10.00 s)

## ◆ C3: Slip Compensation

The Slip Compensation function improves the speed accuracy of an induction motor. As loads on induction motors increase, motor slip increases and motor speed decreases. By adjusting the output frequency in accordance with the motor load, it compensates the slip and makes the motor speed equal to the frequency reference.

### ■ C3-01: Slip Compensation Gain

No. (Hex.)	Name	Description	Default (Range)
C3-01 (020F) RUN	Slip Compensation Gain	<input type="checkbox"/> V/f <input type="checkbox"/> CL-V/f <input type="checkbox"/> OLV <input type="checkbox"/> CLV <input type="checkbox"/> AOLV <input type="checkbox"/> OLV/PM <input type="checkbox"/> AOLV/PM <input type="checkbox"/> CLV/PM <input type="checkbox"/> EZOLV Sets the gain for the slip compensation function. Usually it is not necessary to change this setting.	Determined by A1-02 (0.0 - 2.5)

**Note:**

- Correctly set these parameters before changing the slip compensation gain:
  - E2-01 [Motor Rated Current (FLA)]
  - E2-02 [Motor Rated Slip] (Set during Auto-Tuning when A1-02 = 2 [Control Method Selection = Open Loop Vector])
  - E2-03 [Motor No-Load Current]
- When A1-02 = 3 [Closed Loop Vector], the slip compensation gain becomes the motor temperature compensation gain. When the motor temperature increases, the motor internal constant changes and increases the slip. When you set this parameter, the drive adjusts the slip with the increase in temperature. Adjust the parameter in these conditions. When the setting value increases, the compensation also increases:
  - The drive is doing torque control.
  - There are torque limits.
  - Output torque changes when the temperature changes.

It can be necessary to adjust the parameter in these conditions:

- If the motor speed is slower than the frequency reference, increase this parameter by 0.1.
- If the motor at constant speed is faster than the frequency reference, decrease this parameter by 0.1.

■ **C3-02: Slip Compensation Delay Time**

No. (Hex.)	Name	Description	Default (Range)
C3-02 (0210) RUN	Slip Compensation Delay Time	<div style="display: flex; justify-content: space-between; font-size: small;"> <span>V/f</span> <span>CL-V/f</span> <span>OLV</span> <span>CLV</span> <span>AOLV</span> <span>OLV/PM</span> <span>AOLV/PM</span> <span>CLV/PM</span> <span>EZOLV</span> </div> Sets the slip compensation delay time when speed is unstable or when the slip compensation response is too slow. Usually it is not necessary to change this setting.	Determined by A1-02 (0 - 10000 ms)

It can be necessary to adjust the parameter in these conditions:

- If the speed is not stable, increase this parameter.
- If the slip compensation response is too slow, decrease the setting.

■ **C3-03: Slip Compensation Limit**

No. (Hex.)	Name	Description	Default (Range)
C3-03 (0211)	Slip Compensation Limit	<div style="display: flex; justify-content: space-between; font-size: small;"> <span>V/f</span> <span>CL-V/f</span> <span>OLV</span> <span>CLV</span> <span>AOLV</span> <span>OLV/PM</span> <span>AOLV/PM</span> <span>CLV/PM</span> <span>EZOLV</span> </div> Sets the upper limit for the slip compensation function as a percentage of the motor rated slip.	200% (0 - 250%)

If you increase the value of C3-01 [Slip Compensation Gain] and the motor speed is slow, use this parameter. The drive uses this parameter when the slip is at the upper limit of slip compensation. Make sure that you measure the motor speed when you increase this parameter value. Set this parameter to make the frequency reference and the slip compensation limit less than the permitted range of the machine.

The slip compensation limit is constant in the constant torque range (frequency reference  $\leq$  E1-06 [Base Frequency]). In the constant power range, the frequency reference  $>$  E1-06 increases with the C3-03 value and the output frequency as shown in Figure 11.52.

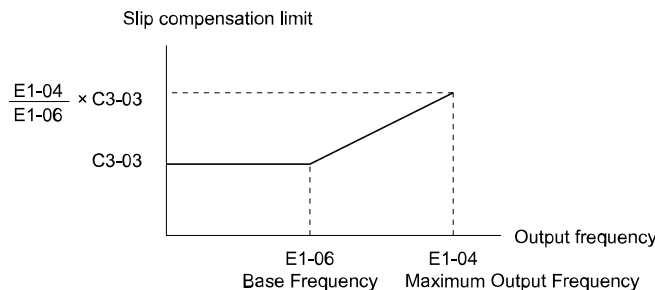


Figure 11.52 Slip Compensation Limit

■ **C3-04: Slip Compensation at Regen**

No. (Hex.)	Name	Description	Default (Range)
C3-04 (0212)	Slip Compensation at Regen	<div style="display: flex; justify-content: space-between; font-size: small;"> <span>V/f</span> <span>CL-V/f</span> <span>OLV</span> <span>CLV</span> <span>AOLV</span> <span>OLV/PM</span> <span>AOLV/PM</span> <span>CLV/PM</span> <span>EZOLV</span> </div> Sets the slip compensation function during regenerative operation.	0 (0 - 2)

If you apply a regenerative load when slip compensation during regeneration is active, it can be necessary to use a dynamic braking option (braking resistor or braking resistor unit).

### 0 : Disabled

The drive does not provide slip compensation.

The load and operation status (regenerative operation) can cause the motor speed to be higher or lower than the frequency reference.

### 1 : Enabled Above 6Hz

Slip compensation function is enabled during regenerative operation. Slip compensation is disabled at output frequencies of 6 Hz or less.

### 2 : Enabled Above C3-15

The drive uses *E2-02 [Motor Rated Slip]* to automatically calculate the frequency range where it will disable slip compensation function during regenerative operation.

Slip compensation is enabled at frequencies as low as 2 Hz.

## ■ C3-05: Output Voltage Limit Selection

No. (Hex.)	Name	Description	Default (Range)
C3-05 (0213)	Output Voltage Limit Selection	<input type="checkbox"/> V/f <input type="checkbox"/> CL-V/f <input checked="" type="checkbox"/> OLV <input checked="" type="checkbox"/> CLV <input type="checkbox"/> AOLV <input type="checkbox"/> OLV/PM <input type="checkbox"/> AOLV/PM <input type="checkbox"/> CLV/PM <input type="checkbox"/> EZOLV Sets the automatic reduction of motor magnetic flux when the output voltage is saturated.	0 (0, 1)

Make sure that the drive has sufficient output current capacity before you enable this parameter. When this parameter is 0 [*Enabled*], the drive increases the output current to a maximum of 10% when the motor is running at constant speed. The drive will also decrease flux and increase current to compensate torque.

Enable this parameter to increase speed precision when you move heavy loads at high speeds in these conditions:

- Power supply voltage is low
- Motor rated voltage is high

Do not enable this parameter in these conditions:

- Operating a motor in the middle speed range or low speed range
- Power supply voltage is a minimum of 10% more than the motor rated voltage

When this parameter is enabled, you could possibly not have accurate torque control if the power supply voltage is much less than the motor rated voltage.

### 0 : Disabled

### 1 : Enabled

## ■ C3-16: Vout Modulation Limit Start Lvl

No. (Hex.)	Name	Description	Default (Range)
C3-16 (0261) Expert	Vout Modulation Limit Start Lvl	<input type="checkbox"/> V/f <input type="checkbox"/> CL-V/f <input checked="" type="checkbox"/> OLV <input checked="" type="checkbox"/> CLV <input type="checkbox"/> AOLV <input type="checkbox"/> OLV/PM <input type="checkbox"/> AOLV/PM <input type="checkbox"/> CLV/PM <input type="checkbox"/> EZOLV Sets the modulation factor that starts the output voltage limit operation when <i>C3-05 = 1 [Output Voltage Limit Selection = Enabled]</i> .	90.0% (70.0 - 90.0%)

## ■ C3-17: Vout Modulation Limit Max Level

No. (Hex.)	Name	Description	Default (Range)
C3-17 (0262) Expert	Vout Modulation Limit Max Level	<input type="checkbox"/> V/f <input type="checkbox"/> CL-V/f <input checked="" type="checkbox"/> OLV <input checked="" type="checkbox"/> CLV <input type="checkbox"/> AOLV <input type="checkbox"/> OLV/PM <input type="checkbox"/> AOLV/PM <input type="checkbox"/> CLV/PM <input type="checkbox"/> EZOLV Sets the modulation factor used with <i>C3-18 [Output Voltage Limit Level]</i> for the output voltage limit operation when <i>C3-05 = 1 [Output Voltage Limit Selection = Enabled]</i> .	100.0% (85.0 - 100.0%)

### ■ C3-18: Output Voltage Limit Level

No. (Hex.)	Name	Description	Default (Range)
C3-18 (0263) Expert	Output Voltage Limit Level	<input type="checkbox"/> V/f <input type="checkbox"/> CL-V/f <input checked="" type="checkbox"/> OLV <input type="checkbox"/> CLV <input type="checkbox"/> AOLV <input type="checkbox"/> OLV/PM <input type="checkbox"/> AOLV/PM <input type="checkbox"/> CLV/PM <input type="checkbox"/> EZOLV Sets the maximum drop width of the voltage reference when $C3-05 = 1$ [ <i>Output Voltage Limit Selection = Enabled</i> ].	90.0% (50.0 - 100.0%)

### ■ C3-21: Motor 2 Slip Compensation Gain

No. (Hex.)	Name	Description	Default (Range)
C3-21 (033E) RUN	Motor 2 Slip Compensation Gain	<input type="checkbox"/> V/f <input type="checkbox"/> CL-V/f <input checked="" type="checkbox"/> OLV <input type="checkbox"/> CLV <input type="checkbox"/> AOLV <input type="checkbox"/> OLV/PM <input type="checkbox"/> AOLV/PM <input type="checkbox"/> CLV/PM <input type="checkbox"/> EZOLV Sets the gain for the motor 2 slip compensation function. Usually it is not necessary to change this setting.	Determined by E3-01 (0.0 - 2.5)

**Note:**

Correctly set these parameters before changing the slip compensation gain:

- E4-01 [*Motor 2 Rated Current*]
- E4-02 [*Motor 2 Rated Slip*] (Set during Auto-Tuning when  $E3-01 = 2$  [*Motor 2 Control Mode Selection = Open Loop Vector*])
- E4-03 [*Motor 2 Rated No-Load Current*]

It can be necessary to adjust this parameter in these conditions:

- If the motor speed is slower than the frequency reference, increase  $C3-01$  in 0.1 unit increments.
- If the motor at constant speed is faster than the frequency reference, decrease  $C3-01$  in 0.1 unit increments.

### ■ C3-22: Motor 2 Slip Comp Delay Time

No. (Hex.)	Name	Description	Default (Range)
C3-22 (0241) RUN	Motor 2 Slip Comp Delay Time	<input type="checkbox"/> V/f <input type="checkbox"/> CL-V/f <input checked="" type="checkbox"/> OLV <input type="checkbox"/> CLV <input type="checkbox"/> AOLV <input type="checkbox"/> OLV/PM <input type="checkbox"/> AOLV/PM <input type="checkbox"/> CLV/PM <input type="checkbox"/> EZOLV Sets the slip compensation delay time for motor 2 when speed is unstable or when the slip compensation response is too slow. Usually it is not necessary to change this setting.	Determined by E3-01 (0 - 10000 ms)

It can be necessary to adjust this parameter in these conditions:

- When the speed is not stable, increase the setting.
- When the slip compensation response is too slow, decrease the setting.

### ■ C3-23: Motor 2 Slip Compensation Limit

No. (Hex.)	Name	Description	Default (Range)
C3-23 (0242)	Motor 2 Slip Compensation Limit	<input type="checkbox"/> V/f <input type="checkbox"/> CL-V/f <input checked="" type="checkbox"/> OLV <input type="checkbox"/> CLV <input type="checkbox"/> AOLV <input type="checkbox"/> OLV/PM <input type="checkbox"/> AOLV/PM <input type="checkbox"/> CLV/PM <input type="checkbox"/> EZOLV Sets the upper limit for the slip compensation function as a percentage of the motor 2 rated slip.	200% (0 - 250%)

If you increase the value of  $C3-21$  [*Motor 2 Slip Compensation Gain*] and the motor speed is slow, use this parameter. The drive uses this parameter when the slip is at the upper limit of slip compensation. Make sure that you measure the motor speed when you increase this parameter value. Set this parameter to make the frequency reference and the slip compensation limit less than the permitted range of the machine.

The slip compensation limit is constant in the constant torque range (frequency reference  $\leq E3-06$  [*Motor 2 Base Frequency*]). In the constant power range, the frequency reference  $> E3-06$  increases with the  $C3-23$  value and the output frequency as shown in [Figure 11.53](#).

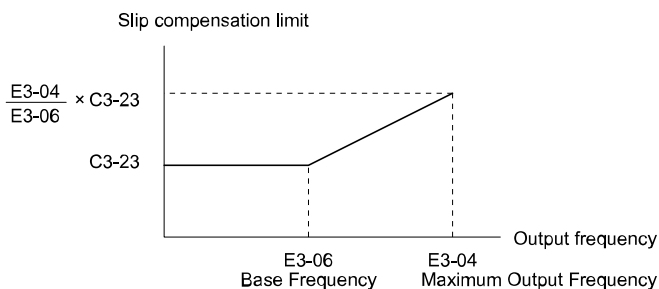


Figure 11.53 Motor 2 Slip Compensation Limit

### ■ C3-24: Motor 2 Slip Comp during Regen

No. (Hex.)	Name	Description	Default (Range)
C3-24 (0243)	Motor 2 Slip Comp during Regen	<input type="checkbox"/> V/f <input type="checkbox"/> CL-V/f <input checked="" type="checkbox"/> OLV <input type="checkbox"/> CLV <input type="checkbox"/> AOLV <input type="checkbox"/> OLV/PM <input type="checkbox"/> AOLV/PM <input type="checkbox"/> CLV/PM <input type="checkbox"/> EZOLV Sets the slip compensation during regenerative operation function for motor 2.	0 (0 - 2)

If you apply a regenerative load when slip compensation during regeneration is active, it can be necessary to use a dynamic braking option (braking resistor or braking resistor unit).

#### 0 : Disabled

The drive does not provide slip compensation.

The load and operation status (regenerative operation) can cause the motor speed to be higher or lower than the frequency reference.

#### 1 : Enabled Above 6Hz

Slip compensation function is enabled during regenerative operation. Slip compensation is disabled at output frequencies of 6 Hz or less.

#### 2 : Enabled Above C3-15

The drive uses *E2-02 [Motor Rated Slip]* to automatically calculate the frequency range where it will disable slip compensation function during regenerative operation.

Slip compensation is enabled at frequencies as low as 2 Hz.

### ■ C3-28: Adaptive Slip Control Mode

No. (Hex.)	Name	Description	Default (Range)
C3-28 (1B5B) Expert	Adaptive Slip Control Mode	<input type="checkbox"/> V/f <input type="checkbox"/> CL-V/f <input type="checkbox"/> OLV <input checked="" type="checkbox"/> CLV <input type="checkbox"/> AOLV <input type="checkbox"/> OLV/PM <input type="checkbox"/> AOLV/PM <input type="checkbox"/> CLV/PM <input type="checkbox"/> EZOLV Sets the slip compensation function mode.	0 (0, 1)

#### 0 : Normal

#### 1 : Advanced

##### Note:

Set *C3-28 = 0* for better torque precision. If the torque precision does not get better, set *C3-28 = 1* and increase the value of *n4-65 [Flux Estimate Response@High Freq]* or *n4-66 [Flux Estimate Response @Low Freq]* in 0.1-unit increments. Then, you must do Rotational Auto-Tuning.

## ◆ C4: Torque Compensation

Torque compensation is a function that increases voltage to increase output torque as compensation for insufficient torque production at start-up or low-speed operation.

Voltage drops due to motor winding resistance cause torque generating voltage to decrease, which causes insufficient torque. If the main circuit cable connecting the drive and motor is long, this can also cause insufficient torque due to voltage drops.

##### Note:

Set the motor parameters and V/f pattern properly before setting *C4 parameters*.

### ■ C4-01: Torque Compensation Gain

No. (Hex.)	Name	Description	Default (Range)
C4-01 (0215) RUN	Torque Compensation Gain	<div style="display: flex; justify-content: space-between; font-size: 0.8em; margin-bottom: 5px;"> <span>V/f</span> <span>CL-V/f</span> <span><b>OLV</b></span> <span>CLV</span> <span>AOLV</span> <span>OLV/PM</span> <span>AOLV/PM</span> <span>CLV/PM</span> <span>EZOLV</span> </div> Sets the gain for the torque compensation function. Use this parameter value for motor 1 when operating multiple motors.	Determined by A1-02 (0.00 - 2.50)

In V/f Control or CL-V/f Control, adjust the value in 0.05 unit increments for these conditions:

- When torque is not sufficient during low-speed operation of 10 Hz or less, increase the setting value
- When there is vibration in the motor or when the motor hunts when operating the drive with a light load, decrease the setting value
- When you use a long motor cable, increase the setting value.

**Note:**

- Adjust *C4-01* to make sure that the output current is not more than the drive rated current during low-speed operation.
- In usual conditions, do not change this parameter in Open Loop Vector Control. It can have a negative effect on torque precision.
- In usual conditions, do not change this parameter in PM Open Loop Vector Control. Setting this value too high can cause overcompensation and motor oscillation.

### ■ C4-02: Torque Compensation Delay Time

No. (Hex.)	Name	Description	Default (Range)
C4-02 (0216) RUN	Torque Compensation Delay Time	<div style="display: flex; justify-content: space-between; font-size: 0.8em; margin-bottom: 5px;"> <span>V/f</span> <span>CL-V/f</span> <span>OLV</span> <span>CLV</span> <span>AOLV</span> <span><b>OLV/PM</b></span> <span>AOLV/PM</span> <span>CLV/PM</span> <span>EZOLV</span> </div> Sets the torque compensation delay time. Usually it is not necessary to change this setting.	Determined by A1-02 (0 - 60000 ms)

It can be necessary to adjust this parameter in these conditions:

- If there is vibration in the motor, increase the setting.
- If the motor speed or motor torque response is too slow, decrease the setting.

### ■ C4-03: Torque Compensation @ FWD Start

No. (Hex.)	Name	Description	Default (Range)
C4-03 (0217)	Torque Compensation @ FWD Start	<div style="display: flex; justify-content: space-between; font-size: 0.8em; margin-bottom: 5px;"> <span>V/f</span> <span>CL-V/f</span> <span><b>OLV</b></span> <span>CLV</span> <span>AOLV</span> <span>OLV/PM</span> <span>AOLV/PM</span> <span>CLV/PM</span> <span>EZOLV</span> </div> Sets the amount of torque reference for forward start as a percentage of the motor rated torque.	0.0% (0.0 - 200.0%)

The drive uses the time constant set in *C4-05 [Torque Compensation Time]* to apply compensation.

When you start the motor with a forward Run command, enable this parameter. Set this parameter to 0.0 to disable this function.

### ■ C4-04: Torque Compensation @ REV Start

No. (Hex.)	Name	Description	Default (Range)
C4-04 (0218)	Torque Compensation @ REV Start	<div style="display: flex; justify-content: space-between; font-size: 0.8em; margin-bottom: 5px;"> <span>V/f</span> <span>CL-V/f</span> <span><b>OLV</b></span> <span>CLV</span> <span>AOLV</span> <span>OLV/PM</span> <span>AOLV/PM</span> <span>CLV/PM</span> <span>EZOLV</span> </div> Sets the amount of torque reference for reverse start as a percentage of the motor rated torque.	0.0% (-200.0 - 0.0%)

The drive uses the time constant set in *C4-05 [Torque Compensation Time]* to apply compensation.

When you start the motor with a reverse Run command, enable this parameter. Set this parameter to 0.0 to disable this function.

### ■ C4-05: Torque Compensation Time

No. (Hex.)	Name	Description	Default (Range)
C4-05 (0219)	Torque Compensation Time	<div style="display: flex; justify-content: space-between; font-size: 0.8em; margin-bottom: 5px;"> <span>V/f</span> <span>CL-V/f</span> <span><b>OLV</b></span> <span>CLV</span> <span>AOLV</span> <span>OLV/PM</span> <span>AOLV/PM</span> <span>CLV/PM</span> <span>EZOLV</span> </div> Sets the starting torque constant to use with <i>C4-03</i> and <i>C4-04 [Torque Compensation @ FWD/REV Start]</i> .	10 ms (0 - 200 ms)



### ■ C4-06: Motor 2 Torque Comp Delay Time

No. (Hex.)	Name	Description	Default (Range)
C4-06 (021A)	Motor 2 Torque Comp Delay Time	<div style="display: flex; justify-content: space-between; font-size: 0.8em; margin-bottom: 5px;"> <span>V/f</span> <span>CL-V/f</span> <span style="background-color: #ccc;">OLV</span> <span>CLV</span> <span>AOLV</span> <span>OLV/PM</span> <span>AOLV/PM</span> <span>CLV/PM</span> <span>EZOLV</span> </div> Sets the value if <i>ov</i> [Overvoltage] occurs with sudden changes in the load, at the end of acceleration, or at the start of deceleration.	150 ms (0 - 10000 ms)

Sets the time constant used during Speed Search or during regenerative operation when *ov* occurs.

Adjust this parameter in the following circumstances.

- Gradually reduce the setting in 10 ms increments and check the performance to improve motor torque speed response when *ov* occurs.

**Note:**

- Ensure that  $C4-06 \geq C4-02$  [Torque Compensation Delay Time].
- Increase the setting value of  $n2-03$  [Automatic Freq Regulator Time 2] proportional to  $C4-06$ .

### ■ C4-07: Motor 2 Torque Compensation Gain

No. (Hex.)	Name	Description	Default (Range)
C4-07 (0341) RUN	Motor 2 Torque Compensation Gain	<div style="display: flex; justify-content: space-between; font-size: 0.8em; margin-bottom: 5px;"> <span>V/f</span> <span>CL-V/f</span> <span style="background-color: #ccc;">OLV</span> <span>CLV</span> <span>AOLV</span> <span>OLV/PM</span> <span>AOLV/PM</span> <span>CLV/PM</span> <span>EZOLV</span> </div> Sets the gain for motor 2 torque compensation function when using the Motor Switch function.	1.00 (0.00 - 2.50)

In V/f Control or CL-V/f Control, adjust the value in 0.05 unit increments for these conditions:

- When torque is not sufficient during low-speed operation of 10 Hz or less, increase the setting value
- When there is vibration in the motor or when the motor hunts when operating the drive with a light load, decrease the setting value
- When you use a long motor cable, increase the setting value.

**Note:**

- Adjust  $C4-07$  to make sure that the output current is not more than the drive rated current when operating the drive with a light load.
- In usual conditions, do not change this parameter in OLV Control. It can have a negative effect on torque precision. Setting this value too high can cause overcompensation and motor oscillation.

### ■ C4-19: Torque Ripple Suppress Min Freq

No. (Hex.)	Name	Description	Default (Range)
C4-19 (0B8D) Expert	Torque Ripple Suppress Min Freq	<div style="display: flex; justify-content: space-between; font-size: 0.8em; margin-bottom: 5px;"> <span>V/f</span> <span>CL-V/f</span> <span style="background-color: #ccc;">OLV</span> <span>CLV</span> <span>AOLV</span> <span>OLV/PM</span> <span>AOLV/PM</span> <span>CLV/PM</span> <span>EZOLV</span> </div> Sets a frequency to limit current and torque ripple. Increase this parameter in 1.0 Hz increments when current ripples and torque ripples occur during low-speed operation. Set this parameter to 0.0 to disable the function if increasing the value does not fix the problem. Usually it is not necessary to change this setting.	0.1 Hz (0.0 - 10.0 Hz)

**Note:**

Set  $C4-20$  [Voltage Compensation Adjust 1]  $\neq 0$  to enable this parameter.

### ■ C4-20: Voltage Compensation Adjust 1

No. (Hex.)	Name	Description	Default (Range)
C4-20 (0BCB) Expert	Voltage Compensation Adjust 1	<div style="display: flex; justify-content: space-between; font-size: 0.8em; margin-bottom: 5px;"> <span>V/f</span> <span>CL-V/f</span> <span style="background-color: #ccc;">OLV</span> <span>CLV</span> <span>AOLV</span> <span>OLV/PM</span> <span>AOLV/PM</span> <span>CLV/PM</span> <span>EZOLV</span> </div> Sets voltage precision compensation. Usually it is not necessary to change this setting.	120 (0 - 200)

**Note:**

When there is audible noise during low-speed operation, set this parameter to 0.

■ **C4-21: Voltage Compensation Adjust 2**

No. (Hex.)	Name	Description	Default (Range)
C4-21 (0BCC) Expert	Voltage Compensation Adjust 2	<div style="display: flex; justify-content: space-between; font-size: small;"> <span>V/f</span> <span>CL-V/f</span> <span>OLV</span> <span>CLV</span> <span>AOLV</span> <span>OLV/PM</span> <span>AOLV/PM</span> <span>CLV/PM</span> <span>EZOLV</span> </div> Sets voltage precision compensation. Usually it is not necessary to change this setting.	5 (0 - 10)

**Note:**

When there is audible noise during high-speed operation, set this parameter to 0.

◆ **C5: Auto Speed Regulator (ASR)**

The ASR adjusts the output frequency or torque reference to decrease the difference between frequency reference and motor speed. The control method sets the parameter that you must adjust.

Control Method	Targets of Adjustment
Closed Loop V/f Control (CL-V/f)	Output frequency
<ul style="list-style-type: none"> <li>• Closed Loop Vector Control (CLV)</li> <li>• Advanced Open Loop Vector Control (AOLV)</li> <li>• Closed Loop Vector Control for PM (CLV/PM)</li> <li>• PM Advanced Open Loop Vector (AOLV/PM)</li> <li>• EZ Vector Control (EZOLV)</li> </ul>	Torque Reference

Figure 11.54 is a speed control block diagram of each control method.

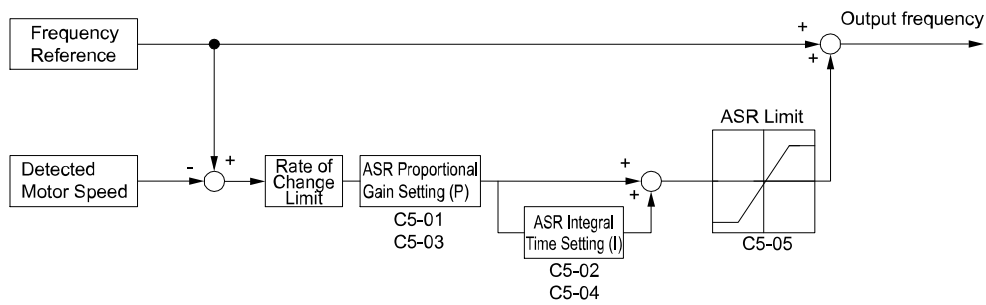


Figure 11.54 Speed Control Block Diagram for Closed Loop V/f Control (CL-V/f)

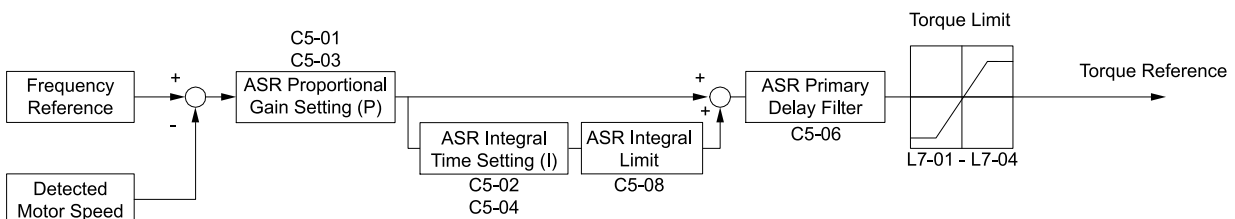


Figure 11.55 Speed Control Block Diagram for CLV, AOLV, CLV/PM, AOLV/PM, and EZOLV

**Note:**

The detected speed is the speed estimation value when configured such that A1-02 = 4, 6, or 8 [Control Method Selection = AOLV, AOLV/PM, or EZOLV].

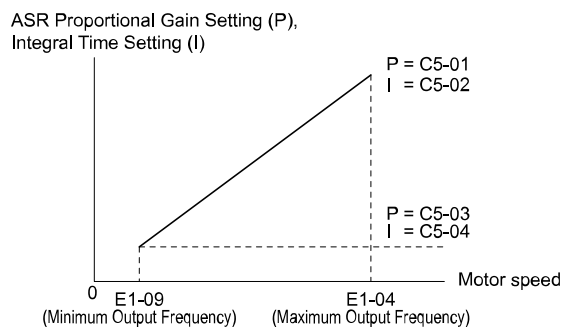
■ **Before You Adjust ASR Parameters**

- Do Auto-Tuning and set up all motor data correctly.
- Always make adjustments with the load connected to the motor.
- Use analog output signals to monitor U1-16 [SFS Output Frequency] and U1-05 [Motor Speed] when you adjust the ASR.

■ **ASR Adjustment Procedure for Closed Loop V/f Control (CL-V/f)**

Do this procedure to adjust ASR parameters:

1. Run the motor at minimum speed and increase C5-03 [ASR Proportional Gain 2] as much as possible without oscillation.



**Figure 11.56 ASR Gain and Integral Time Adjustment**

- Run the motor at minimum speed and decrease *C5-04* [ASR Integral Time 2] as much as possible without oscillation.
- Check the output current monitor to make sure that the output current is less than 50% of the drive rated current. If the setting value is higher than 50%, decrease *C5-03* and increase *C5-04*.
- Run the motor at maximum speed and increase *C5-01* [ASR Proportional Gain 1] as much as possible without oscillations.
- Run the motor at maximum speed and decrease *C5-02* [ASR Integral Time 1] as much as possible without oscillations.
- If higher speed precision and faster response during acceleration or deceleration are necessary, set *C5-12* = 1 [Integral Operation @ Accel/Decel = Enabled] to enable integral control during acceleration/decel.

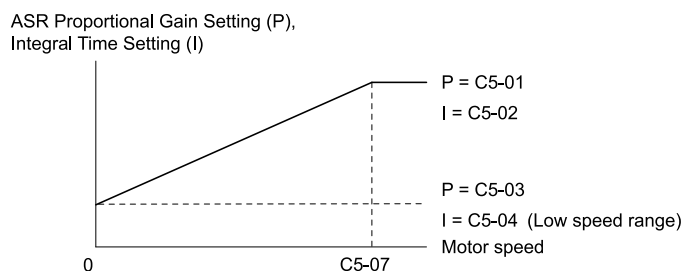
**Note:**

- If overshooting occurs when acceleration ends, decrease the value set in *C5-01* and increase the value set in *C5-02*.
- If undershoot occurs at stop, decrease *C5-03* and increase *C5-04*.
- If you adjust the gain and it does not correct overshooting and undershooting, decrease the value set in *C5-05* [ASR Limit] to decrease the upper limit of the frequency reference compensation.

## ■ ASR Adjustment Procedure for CLV, AOLV, AOLV/PM, CLV/PM, and EZOLV

Do this procedure to adjust ASR parameters:

- Run the motor at zero speed or low speed and increase *C5-01* [ASR Proportional Gain 1] until immediately before vibration starts to occur.
- Run the motor at zero speed or low speed and decrease *C5-02* [ASR Integral Time 1] until immediately before vibration starts to occur.
- Check for oscillation when you run the motor at maximum speed.
- If oscillation occurs, increase *C5-02* and decrease *C5-01*. When there is no oscillation, the adjustment procedure is complete.
- Set the low-speed gain. Run the motor at zero speed or low speed and increase *C5-03* [ASR Proportional Gain 2] until immediately before vibration starts to occur.



**Figure 11.57 Low-speed/High-speed Gain Settings**

- Set the low-speed integral time. Run the motor at zero speed or low speed and decrease *C5-04* [ASR Integral Time 2] until immediately before vibration starts to occur.
- Set *C5-07* [ASR Gain Switchover Frequency].
- Check for oscillation when you run the motor at speeds more than the setting in *C5-07*.

**Note:**

- If overshooting occurs when acceleration ends, decrease the value set in *C5-01* and increase the value set in *C5-02*.
- If undershoot occurs at stop, decrease *C5-03* and increase *C5-04*.

### ■ Use MFDI Switch for Proportional Gain

**Note:**

If  $A1-02 = 1$  [Control Method Selection = V/f Control with Encoder], you cannot use this function.

You can use the input terminals set for ASR Gain (C5-03) Select [ $H1-xx = 77$ ] to switch the proportional gains set with C5-01 and C5-03. When the configured input terminal is deactivated, the proportional gain set for C5-01 is selected. When the terminal is activated, the proportional gain set for C5-03 is selected. The proportional gain changes linearly over the time set in C5-02 [ASR Integral Time 1]. The signals from this MFDI are more important than C5-07 [ASR Gain Switchover Frequency].

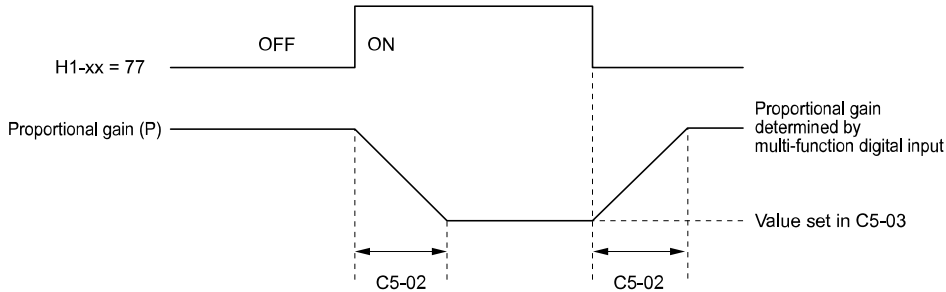


Figure 11.58 Proportional Gain through Multi-function Digital Input Switch

### ■ Speed Waveform Monitoring Method

To make small adjustments of ASR parameters, monitor the speed waveforms when you make the adjustments. Table 11.37 shows example settings of parameters to monitor speed waveforms.

Table 11.37 Example Settings of MFAO Terminals to Monitor Speed Waveforms

No.	Name	Setting Value	Description
H4-01	Terminal FM Analog Output Select	116	Lets you use terminal FM to monitor U1-16 [SFS Output Frequency].
H4-02	Terminal FM Analog Output Gain	100.0%	
H4-03	Terminal FM Analog Output Bias	0.0%	
H4-04	Terminal AM Analog Output Select	105	Lets you use the terminal AM to monitor U1-05 [Motor Speed].
H4-05	Terminal AM Analog Output Gain	50.0%	
H4-06	Terminal AM Analog Output Bias	0.0%	
H4-07	Terminal FM Signal Level Select	1	Lets you monitor in a -10 to +10 V range.
H4-08	Terminal AM Signal Level Select	1	

These settings cause this MFAO configuration. The MFAO common is terminal AC:

- Terminal FM: Outputs the output frequency after SFS in a -10 to +10 V (-100 to +10) range.
- Terminal AM: Outputs the motor speed in a -10 to +10 V (-200 to +20) range.

Yaskawa recommends that you monitor the output frequency after SFS and the motor speed for delays in response and differences in reference values.

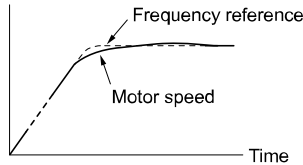
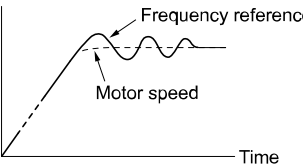
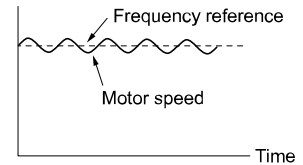
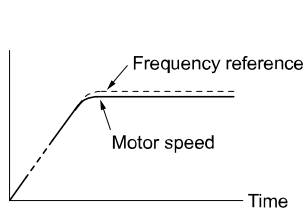
### ■ Adjust ASR Parameters

Use Table 11.38 to adjust ASR. The table lists parameters for motor 1, but you can make the same changes to motor 2 parameters when you run a second motor.

**Note:**

When adjusting the proportional gain and integral time, adjust the proportional gain first.

**Table 11.38 ASR Response and Possible Solutions**

Problem	Possible Solutions
<p>Speed response is slow.</p> 	<ul style="list-style-type: none"> <li>• Increase C5-01/C5-03 [ASR Proportional Gain].</li> <li>• Decrease C5-02/C5-04 [ASR Integral Time].</li> </ul>
<p>Overshoot or undershoot occurs at the end of acceleration or deceleration.</p> 	<ul style="list-style-type: none"> <li>• Decrease C5-01/C5-03.</li> <li>• Increase C5-02/C5-04.</li> </ul>
<p>Vibration and oscillation occur at constant speed.</p> 	<ul style="list-style-type: none"> <li>• Decrease C5-01/C5-03.</li> <li>• Increase C5-02/C5-04.</li> <li>• Increase C5-06 [ASR Delay Time].</li> </ul>
<p>Speed accuracy is unsatisfactory when you operate a motor that has a large quantity of rated slip in Closed Loop V/f Control.</p> 	<ul style="list-style-type: none"> <li>• Check the pulse number set to F1-01 [Encoder 1 Pulse Count (PPR)] and the gear ratio to F1-12 [Encoder 1 Gear Teeth 1] and F1-13 [Encoder 1 Gear Teeth 2].</li> <li>• Make sure that you correctly set the pulse signal from the encoder.</li> <li>• Check U6-04 [ASR Output] to make sure that the ASR operates at its output limit set to C5-05 [ASR Limit]. If the ASR is at the output limit, increase C5-05.</li> </ul>
<p>If C5-12 = 1 or C5-32 = 1 [Enabled] in Closed Loop V/f Control and over/undershoot occurs when you change speeds.</p> <p style="text-align: center;">-</p>	<ul style="list-style-type: none"> <li>• Decrease C5-01/C5-03.</li> <li>• Increase C5-02/C5-04.</li> <li>• Decrease the value set to C5-05.</li> </ul>
<p>Oscillation at low speed and response is too slow at high speed. Oscillation at high speed and response is too slow at low speed.</p> <p style="text-align: center;">-</p>	<ul style="list-style-type: none"> <li>• Closed Loop V/f Control Mode: Use C5-03 and C5-04 at maximum speed and C5-01 and C5-02 at minimum speed to set different ASR settings.</li> <li>• Closed Loop Vector Control, PM Advanced Open Loop Vector Control, and PM Closed Loop Vector Control: Use C5-01 to C5-04 to set the best ASR settings for high and low speed. Use C5-07 [ASR Gain Switchover Frequency] to switch the ASR proportional gain and ASR integral time as specified by the output frequency.</li> </ul>

■ **C5-01: ASR Proportional Gain 1**

No. (Hex.)	Name	Description	Default (Range)
C5-01 (021B) RUN	ASR Proportional Gain 1	<p>V/f <input type="checkbox"/> CL-V/f <input type="checkbox"/> OLV <input type="checkbox"/> CLV <input type="checkbox"/> AOLV <input type="checkbox"/> OLV/PM <input type="checkbox"/> AOLV/PM <input type="checkbox"/> CLV/PM <input type="checkbox"/> EZOLV <input type="checkbox"/></p> <p>Sets the gain to adjust ASR response.</p>	Determined by A1-02 (0.00 - 300.00)

The speed response increases as the gain increases. Usually, the gain increases with larger loads. Too much gain causes vibration.

**Note:**

- The drive usually sets Motor 1 ASR with C5-01 and C5-02 [ASR Integral Time 1]. To use C5-03 [ASR Proportional Gain 2] as an alternative to C5-01 set H1-xx = 77 [MFDI Function Select = ASR Gain (C5-03) Select]. You can also use C5-01 as an alternative to C5-04 [ASR Integral Time 2] when the speed is less than or equal to the frequency set in C5-07 [ASR Gain Switchover Frequency].
- The drive automatically adjusts C5-01 in ASR Tuning.

### ■ C5-02: ASR Integral Time 1

No. (Hex.)	Name	Description	Default (Range)
C5-02 (021C) RUN	ASR Integral Time 1	<input type="checkbox"/> V/f <input checked="" type="checkbox"/> CL-V/f <input type="checkbox"/> OLV <input checked="" type="checkbox"/> CLV <input type="checkbox"/> AOLV <input type="checkbox"/> OLV/PM <input type="checkbox"/> AOLV/PM <input type="checkbox"/> CLV/PM <input type="checkbox"/> EZOLV Sets the ASR integral time.	Determined by A1-02 (0.000 - 60.000 s)

An integral time that is too long will decrease the responsiveness of the speed control and decrease drive response to dynamic changes in motor load. An integral time that is too short can cause oscillation.

### ■ C5-03: ASR Proportional Gain 2

No. (Hex.)	Name	Description	Default (Range)
C5-03 (021D) RUN	ASR Proportional Gain 2	<input type="checkbox"/> V/f <input checked="" type="checkbox"/> CL-V/f <input type="checkbox"/> OLV <input checked="" type="checkbox"/> CLV <input type="checkbox"/> AOLV <input type="checkbox"/> OLV/PM <input type="checkbox"/> AOLV/PM <input type="checkbox"/> CLV/PM <input type="checkbox"/> EZOLV Sets the gain to adjust ASR response.	Determined by A1-02 (0.00 - 300.00)

The speed response increases as the weight of the load increases. Usually, the gain increases with larger loads. Too much gain will cause vibration.

### ■ C5-04: ASR Integral Time 2

No. (Hex.)	Name	Description	Default (Range)
C5-04 (021E) RUN	ASR Integral Time 2	<input type="checkbox"/> V/f <input checked="" type="checkbox"/> CL-V/f <input type="checkbox"/> OLV <input checked="" type="checkbox"/> CLV <input type="checkbox"/> AOLV <input type="checkbox"/> OLV/PM <input type="checkbox"/> AOLV/PM <input type="checkbox"/> CLV/PM <input type="checkbox"/> EZOLV Sets the ASR integral time.	Determined by A1-02 (0.000 - 60.000 s)

An integral time that is too long will decrease the responsiveness of the speed control and decrease drive response to dynamic changes in motor load. An integral time that is too short can cause oscillation.

### ■ C5-05: ASR Limit

No. (Hex.)	Name	Description	Default (Range)
C5-05 (021F)	ASR Limit	<input type="checkbox"/> V/f <input checked="" type="checkbox"/> CL-V/f <input type="checkbox"/> OLV <input type="checkbox"/> CLV <input type="checkbox"/> AOLV <input type="checkbox"/> OLV/PM <input type="checkbox"/> AOLV/PM <input type="checkbox"/> CLV/PM <input type="checkbox"/> EZOLV Sets the ASR output limit as a percentage of E1-04 [Maximum Output Frequency].	5.0% (0.0 - 20.0%)

If the motor rated slip is high, it could be necessary to increase the setting to provide correct motor speed control. Use U6-04 [ASR Output] to make sure that ASR is operating at the limit set in this parameter. When ASR is operating at the limit, correctly set the PG signal and these parameters before you make changes to C5-05:

- F1-01 [Encoder 1 Pulse Count (PPR)]
- F1-12 [Encoder 1 Gear Teeth 1]
- F1-13 [Encoder 1 Gear Teeth 2]

### ■ C5-06: ASR Delay Time

No. (Hex.)	Name	Description	Default (Range)
C5-06 (0220)	ASR Delay Time	<input type="checkbox"/> V/f <input checked="" type="checkbox"/> CL-V/f <input type="checkbox"/> OLV <input checked="" type="checkbox"/> CLV <input type="checkbox"/> AOLV <input type="checkbox"/> OLV/PM <input type="checkbox"/> AOLV/PM <input type="checkbox"/> CLV/PM <input type="checkbox"/> EZOLV Sets the filter time constant for the time from the speed loop to the torque command output. Usually it is not necessary to change this setting.	Determined by A1-02 (0.000 - 0.500 s)

If you have a load with low rigidity or if oscillation is a problem, increase this setting in 0.01 unit increments.

### ■ C5-07: ASR Gain Switchover Frequency

No. (Hex.)	Name	Description	Default (Range)
C5-07 (0221)	ASR Gain Switchover Frequency	<div style="display: flex; justify-content: space-between; font-size: small;"> <span>V/f</span> <span>CL-V/f</span> <span>OLV</span> <span><b>CLV</b></span> <span>AOLV</span> <span>OLV/PM</span> <span>AOLV/PM</span> <span>CLV/PM</span> <span>EZOLV</span> </div> Sets the frequency where the drive will switch between these parameters: <i>C5-01 and C5-03 [ASR Proportional Gain 1/2]</i> <i>C5-02 and C5-04 [ASR Integral Time 1/2]</i>	Determined by A1-02 (Determined by A1-02)

Switching the proportional gain and integral time in the low or high speed range can help operation become stable. A good switching point is 80% of the frequency where oscillation occurs or at 80% of the maximum output frequency.

**Note:**

An MFDI set for  $H1-xx = 77$  [MFDI Function Select = ASR Gain (C5-03) Select] will have priority over the ASR gain switching frequency.

### ■ C5-08: ASR Integral Limit

No. (Hex.)	Name	Description	Default (Range)
C5-08 (0222)	ASR Integral Limit	<div style="display: flex; justify-content: space-between; font-size: small;"> <span>V/f</span> <span>CL-V/f</span> <span>OLV</span> <span><b>CLV</b></span> <span>AOLV</span> <span>OLV/PM</span> <span>AOLV/PM</span> <span>CLV/PM</span> <span>EZOLV</span> </div> Sets the upper limit for ASR as a percentage of the rated load.	400% (0 - 400%)

### ■ C5-12: Integral Operation @ Accel/Decel

No. (Hex.)	Name	Description	Default (Range)
C5-12 (0386)	Integral Operation @ Accel/Decel	<div style="display: flex; justify-content: space-between; font-size: small;"> <span>V/f</span> <span><b>CL-V/f</b></span> <span>OLV</span> <span>CLV</span> <span>AOLV</span> <span>OLV/PM</span> <span>AOLV/PM</span> <span>CLV/PM</span> <span>EZOLV</span> </div> Sets integral operation during acceleration and deceleration.	0 (0, 1)

If you enable integral operation when you are driving a heavy load or a high inertia load, it could cause problems with overshoot or undershoot at the end of acceleration and deceleration. If there are problems with overshooting and undershooting, set this parameter to

**0 : Disabled**

Integral operation is not enabled during acceleration or deceleration. Integral operation is always enabled during constant speed.

**1 : Enabled**

Integral operation is always enabled.

### ■ C5-17: Motor Inertia

No. (Hex.)	Name	Description	Default (Range)
C5-17 (0276) Expert	Motor Inertia	<div style="display: flex; justify-content: space-between; font-size: small;"> <span>V/f</span> <span>CL-V/f</span> <span>OLV</span> <span><b>CLV</b></span> <span>AOLV</span> <span>OLV/PM</span> <span>AOLV/PM</span> <span>CLV/PM</span> <span>EZOLV</span> </div> Sets the motor inertia.	Determined by o2-04, C6-01, and E5-01 (0.0001 - 6.0000 kgm <sup>2</sup> )

When  $A1-02 = 3$  or  $7$  [Control Method Selection = CLV or CLV/PM], the drive automatically sets C5-17 to the value of [Motor Inertia] when you do Inertia Tuning or ASR Tuning.

### ■ C5-18: Load Inertia Ratio

No. (Hex.)	Name	Description	Default (Range)
C5-18 (0277) Expert	Load Inertia Ratio	<div style="display: flex; justify-content: space-between; font-size: small;"> <span>V/f</span> <span>CL-V/f</span> <span>OLV</span> <span><b>CLV</b></span> <span>AOLV</span> <span>OLV/PM</span> <span>AOLV/PM</span> <span>CLV/PM</span> <span>EZOLV</span> </div> Sets the load inertia ratio for the motor inertia.	1.0 (0.0 - 6000.0)

When  $A1-02 = 3$  or  $7$  [Control Method Selection = CLV or CLV/PM], the drive automatically sets C5-18 to the load inertia ratio when you do Inertia Tuning or ASR Tuning.

### ■ C5-21: Motor 2 ASR Proportional Gain 1

No. (Hex.)	Name	Description	Default (Range)
C5-21 (0356) RUN	Motor 2 ASR Proportional Gain 1	<span>V/f</span> <span>CL-V/f</span> <span>OLV</span> <span>CLV</span> <span>AOLV</span> <span>OLV/PM</span> <span>AOLV/PM</span> <span>CLV/PM</span> <span>EZOLV</span> Sets the gain to adjust ASR response for motor 2.	Determined by E3-01 (0.00 - 300.00)

The speed response increases as the weight of the load increases. Usually, the gain increases with larger loads. Too much gain causes vibration.

**Note:**

- The drive usually sets Motor 2 ASR with C5-21 and C5-22 [Motor 2 ASR Integral Time 1]. You can also use C5-23 [Motor 2 ASR Proportional Gain 2] as an alternative to C5-21 when the speed is less than or equal to the frequency set in C5-27 [Motor 2 ASR Gain Switchover Freq]. To use C5-23 as an alternative to C5-21, set H1-xx = 77 [MFDI Function Select = ASR Gain (C5-03) Select].
- The drive automatically adjusts C5-21 in ASR Tuning.

### ■ C5-22: Motor 2 ASR Integral Time 1

No. (Hex.)	Name	Description	Default (Range)
C5-22 (0357) RUN	Motor 2 ASR Integral Time 1	<span>V/f</span> <span>CL-V/f</span> <span>OLV</span> <span>CLV</span> <span>AOLV</span> <span>OLV/PM</span> <span>AOLV/PM</span> <span>CLV/PM</span> <span>EZOLV</span> Sets the ASR integral time for motor 2.	Determined by E3-01 (0.000 - 60.000 s)

An integral time that is too long will decrease the responsiveness of the speed control and decrease drive response to dynamic changes in motor load. An integral time that is too short can cause oscillation.

**Note:**

The drive usually sets Motor 2 ASR with C5-21 [Motor 2 ASR Proportional Gain 1] and C5-22. You can also use C5-24 [Motor 2 ASR Integral Time 2] as an alternative to C5-22 when the speed is less than or equal to the frequency set in C5-27 [Motor 2 ASR Gain Switchover Freq].

### ■ C5-23: Motor 2 ASR Proportional Gain 2

No. (Hex.)	Name	Description	Default (Range)
C5-23 (0358) RUN	Motor 2 ASR Proportional Gain 2	<span>V/f</span> <span>CL-V/f</span> <span>OLV</span> <span>CLV</span> <span>AOLV</span> <span>OLV/PM</span> <span>AOLV/PM</span> <span>CLV/PM</span> <span>EZOLV</span> Sets the gain to adjust ASR response for motor 2.	Determined by E3-01 (0.00 - 300.00)

The speed response increases as the weight of the load increases. Usually, the gain increases with larger loads. Too much gain causes vibration.

### ■ C5-24: Motor 2 ASR Integral Time 2

No. (Hex.)	Name	Description	Default (Range)
C5-24 (0359) RUN	Motor 2 ASR Integral Time 2	<span>V/f</span> <span>CL-V/f</span> <span>OLV</span> <span>CLV</span> <span>AOLV</span> <span>OLV/PM</span> <span>AOLV/PM</span> <span>CLV/PM</span> <span>EZOLV</span> Sets the ASR integral time for motor 2.	Determined by E3-01 (0.000 - 60.000 s)

An integral time that is too long will decrease the responsiveness of the speed control and decrease drive response to dynamic changes in motor load. An integral time that is too short can cause oscillation.

**Note:**

The drive usually sets Motor 2 ASR with C5-21 [Motor 2 ASR Proportional Gain 1] and C5-22 [Motor 2 ASR Integral Time 1]. You can also use C5-24 can also be used instead of C5-22 when the speed is less than or equal to the frequency set in C5-27 [Motor 2 ASR Gain Switchover Freq].



### ■ C5-25: Motor 2 ASR Limit

No. (Hex.)	Name	Description	Default (Range)
C5-25 (035A)	Motor 2 ASR Limit	<div style="display: flex; justify-content: space-between; font-size: 0.8em; margin-bottom: 5px;"> <span>V/f</span> <span>CL-V/f</span> <span>OLV</span> <span>CLV</span> <span>AOLV</span> <span>OLV/PM</span> <span>AOLV/PM</span> <span>CLV/PM</span> <span>EZOLV</span> </div> Sets the ASR output limit for motor 2 as a percentage of E1-04 [Maximum Output Frequency].	5.0% (0.0 - 20.0%)

If the motor rated slip is high, it could be necessary to increase the setting to provide correct motor speed control. Use U6-04 [ASR Output] to make sure that ASR is operating at the limit set in this parameter. When ASR is operating at the limit, correctly set the PG signal and these parameters before you make changes to C5-25:

- F1-31 [Encoder 2 Pulse Count (PPR)]
- F1-33 [Encoder 2 Gear Teeth 1]
- F1-34 [Encoder 2 Gear Teeth 2]

### ■ C5-26: Motor 2 ASR Delay Time

No. (Hex.)	Name	Description	Default (Range)
C5-26 (035B)	Motor 2 ASR Delay Time	<div style="display: flex; justify-content: space-between; font-size: 0.8em; margin-bottom: 5px;"> <span>V/f</span> <span>CL-V/f</span> <span>OLV</span> <span>CLV</span> <span>AOLV</span> <span>OLV/PM</span> <span>AOLV/PM</span> <span>CLV/PM</span> <span>EZOLV</span> </div> Sets the filter time constant for the time from the speed loop to the torque command output for motor 2. Usually it is not necessary to change this setting.	Determined by E3-01 (0.000 - 0.500 s)

If you have a load with low rigidity or if oscillation is a problem, increase this setting in 0.01 unit increments.

### ■ C5-27: Motor 2 ASR Gain Switchover Freq

No. (Hex.)	Name	Description	Default (Range)
C5-27 (035C)	Motor 2 ASR Gain Switchover Freq	<div style="display: flex; justify-content: space-between; font-size: 0.8em; margin-bottom: 5px;"> <span>V/f</span> <span>CL-V/f</span> <span>OLV</span> <span>CLV</span> <span>AOLV</span> <span>OLV/PM</span> <span>AOLV/PM</span> <span>CLV/PM</span> <span>EZOLV</span> </div> Sets the frequency where the drive will switch between these parameters: C5-21 and C5-23 [Motor 2 ASR Proportional Gain 1/2] C5-22 and C5-24 [Motor 2 ASR Integral Time 1/2]	0.0 (0.0 - 400.0)

Switching the proportional gain and integral time in the low or high speed range can help operation become stable. A good switching point is 80% of the frequency where oscillation occurs or at 80% of the maximum output frequency.

**Note:**

An MFDI set for H1-xx = 77 [MFDI Function Select = ASR Gain (C5-03) Select] will have priority over the ASR gain switching frequency.

### ■ C5-28: Motor 2 ASR Integral Limit

No. (Hex.)	Name	Description	Default (Range)
C5-28 (035D)	Motor 2 ASR Integral Limit	<div style="display: flex; justify-content: space-between; font-size: 0.8em; margin-bottom: 5px;"> <span>V/f</span> <span>CL-V/f</span> <span>OLV</span> <span>CLV</span> <span>AOLV</span> <span>OLV/PM</span> <span>AOLV/PM</span> <span>CLV/PM</span> <span>EZOLV</span> </div> Sets the upper limit for ASR for motor 2 as a percentage of the rated load.	400% (0 - 400%)

### ■ C5-29: Speed Control Response

No. (Hex.)	Name	Description	Default (Range)
C5-29 (0B18) Expert	Speed Control Response	<div style="display: flex; justify-content: space-between; font-size: 0.8em; margin-bottom: 5px;"> <span>V/f</span> <span>CL-V/f</span> <span>OLV</span> <span>CLV</span> <span>AOLV</span> <span>OLV/PM</span> <span>AOLV/PM</span> <span>CLV/PM</span> <span>EZOLV</span> </div> Sets the level of speed control responsiveness. Usually it is not necessary to change this setting.	0 (0, 1)

If a high level of speed control responsiveness is necessary, set C5-29 = 1, then adjust the speed control (ASR) parameter.

**0 : Standard**

**1 : High Performance 1**

### ■ C5-32: Motor 2 Integral Oper at Acc/Dec

No. (Hex.)	Name	Description	Default (Range)
C5-32 (0361)	Motor 2 Integral Oper at Acc/Dec	<span>V/f</span> <span>CL-V/f</span> <span>OLV</span> <span>CLV</span> <span>AOLV</span> <span>OLV/PM</span> <span>AOLV/PM</span> <span>CLV/PM</span> <span>EZOLV</span> Sets integral operation during acceleration and deceleration for motor 2.	0 (0, 1)

If you enable integral operation when you are driving a heavy load or a high inertia load, it could cause problems with overshoot or undershoot at the end of acceleration and deceleration. If there are problems with overshooting and undershooting, set this parameter to 0.

#### 0 : Disabled

Integral operation is not enabled during acceleration or deceleration. Integral operation is always enabled during constant speed.

#### 1 : Enabled

Integral operation is always enabled.

### ■ C5-37: Motor 2 Inertia

No. (Hex.)	Name	Description	Default (Range)
C5-37 (0278) Expert	Motor 2 Inertia	<span>V/f</span> <span>CL-V/f</span> <span>OLV</span> <span>CLV</span> <span>AOLV</span> <span>OLV/PM</span> <span>AOLV/PM</span> <span>CLV/PM</span> <span>EZOLV</span> Sets the motor inertia for motor 2.	Determined by o2-04 and C6-01 (0.0001 - 6.0000 kgm <sup>2</sup> )

The drive automatically sets C5-37 to the value of [Motor Inertia] when you do Inertia Tuning or ASR Tuning.

### ■ C5-38: Motor 2 Load Inertia Ratio

No. (Hex.)	Name	Description	Default (Range)
C5-38 (0279) Expert	Motor 2 Load Inertia Ratio	<span>V/f</span> <span>CL-V/f</span> <span>OLV</span> <span>CLV</span> <span>AOLV</span> <span>OLV/PM</span> <span>AOLV/PM</span> <span>CLV/PM</span> <span>EZOLV</span> Sets the load inertia ratio for the motor 2 inertia.	1.0 (0.0 - 6000.0)

The drive automatically sets C5-38 to the value of [Load Inertia Ratio] when you do Inertia Tuning or ASR Tuning.

### ■ C5-39: ASR Primary Delay Time Const 2

No. (Hex.)	Name	Description	Default (Range)
C5-39 (030D)	ASR Primary Delay Time Const 2	<span>V/f</span> <span>CL-V/f</span> <span>OLV</span> <span>CLV</span> <span>AOLV</span> <span>OLV/PM</span> <span>AOLV/PM</span> <span>CLV/PM</span> <span>EZOLV</span> Sets the filter time constant for the time from the speed loop to the torque command output for motor 2. Usually it is not necessary to change this setting.	0.000 s (0.000 - 0.500 s)

If you have a load with low rigidity or if oscillation is a problem, increase this setting in 0.01 unit increments.

### ■ C5-50: Notch Filter Frequency

No. (Hex.)	Name	Description	Default (Range)
C5-50 (0B14) Expert	Notch Filter Frequency	<span>V/f</span> <span>CL-V/f</span> <span>OLV</span> <span>CLV</span> <span>AOLV</span> <span>OLV/PM</span> <span>AOLV/PM</span> <span>CLV/PM</span> <span>EZOLV</span> Sets the machine resonance frequency.	0 Hz (0, or 2 to 100 Hz)

Machine resonance can cause high-frequency noise and vibration during operation. A notch filter can help prevent the noise and vibration. Notch filters set the resonant frequency of the machine to remove specific vibrational frequency components caused by machine resonance.

**Note:**

- Correctly set the value for the notch filter frequency. If the frequency value is too low in regards to the speed loop response frequency, it could have an effect on the speed control functionality. Set the frequency to be a minimum of 4 times the speed loop response frequency.
- Set this parameter to 0 Hz to disable the notch filter.

### ■ C5-51: Notch Filter Bandwidth

No. (Hex.)	Name	Description	Default (Range)
C5-51 (0B15) Expert	Notch Filter Bandwidth	<div style="display: flex; justify-content: space-between; font-size: small;"> <span>V/f</span> <span>CL-V/f</span> <span>OLV</span> <span style="background-color: #cccccc;">CLV</span> <span>AOLV</span> <span>OLV/PM</span> <span>AOLV/PM</span> <span style="background-color: #cccccc;">CLV/PM</span> <span>EZOLV</span> </div> Sets the notch width of the notch filter.	1.0 (0.5 - 5.0)

### ◆ C6: Duty & Carrier Frequency

*C6 parameters* are used to set the selection of drive duty rating, selection of carrier frequency, and upper and lower limits of carrier frequencies.

#### ■ C6-01: Normal / Heavy Duty Selection

No. (Hex.)	Name	Description	Default (Range)
C6-01 (0223)	Normal / Heavy Duty Selection	<div style="display: flex; justify-content: space-between; font-size: small;"> <span>V/f</span> <span>CL-V/f</span> <span>OLV</span> <span style="background-color: #cccccc;">CLV</span> <span>AOLV</span> <span>OLV/PM</span> <span>AOLV/PM</span> <span>CLV/PM</span> <span style="background-color: #cccccc;">EZOLV</span> </div> Sets the drive duty rating.	0 (0, 1)

#### 0 : Heavy Duty Rating

The overload tolerance is 150% of the rated output current for 60 seconds.

#### 1 : Normal Duty Rating

The overload tolerance is 110% of the rated output current for 60 seconds.

There are two types of load ratings for this product depending on the load characteristics of the application: Heavy Duty Rating (HD) and Normal Duty Rating (ND).

The drive rated output current, overload tolerance, and acceleration stall prevention level change when the duty rating changes. Set the drive to agree with the duty rating of the selected drive capacity. In HD, the tolerance is 150% overload for 60 seconds. In ND, the tolerance is 110% overload for 60 seconds. The rated output current for ND drives is higher than the rated output current for HD drives. Refer to “Model Specifications (200 V Class)” and “Model Specifications (400 V Class)” for more information about rated output current.

**Note:**

This product has two more load characteristic types: HD2 and ND2. When the value of *E1-01 [Input AC Supply Voltage]* is 460 V or more, the load characteristic level automatically changes from HD1 to HD2 or from ND1 to ND2.

**Table 11.39 Differences between Heavy Duty Rating and Normal Duty Rating**

Item	Heavy Duty Rating 1 (HD1)	Heavy Duty Rating 2 (HD2)	Normal Duty Rating 1 (ND1)	Normal Duty Rating 2 (ND2)
E1-01 Setting	200 V ≤ E1-01 ≤ 240 V 380 V ≤ E1-01 < 460 V	460 V ≤ E1-01 < 480 V	200 V ≤ E1-01 ≤ 240 V 380 V ≤ E1-01 < 460 V	460 V ≤ E1-01 < 480 V
C6-01 Setting	0		1	
Load Characteristics				
Application	A high overload tolerance is necessary during start up, acceleration, deceleration, and equivalent conditions. <ul style="list-style-type: none"> <li>• Extruder</li> <li>• Conveyor</li> <li>• Cranes and hoists</li> <li>• Constant torque or high overload capacity are necessary.</li> </ul>		Overload tolerance is not necessary. <ul style="list-style-type: none"> <li>• Fan</li> <li>• Pump</li> <li>• Blower</li> </ul>	

## 11.4 C: Tuning

Item	Heavy Duty Rating 1 (HD1)	Heavy Duty Rating 2 (HD2)	Normal Duty Rating 1 (ND1)	Normal Duty Rating 2 (ND2)
Overload Tolerance	150% - 60 seconds		110% - 60 seconds	
Stall Prevent Level during Accel	150%		110%	
Stall Prevent Level during Run	150%		110%	
Carrier Frequency	2 kHz		2 kHz Swing-PWM	

**Note:**

- Set the stall prevention level during acceleration with *L3-02* and the stall prevention level during run with *L3-06*.
- Changing *C6-01* also changes the maximum capacity of applicable drive motors. The drive automatically changes the setting values *E2-xx* and *E4-xx* to applicable values. The drive also automatically changes these parameters that depend on motor output:
  - b8-04 [Energy Saving Coefficient Value]
  - C5-17 [Motor Inertia]
  - C5-37 [Motor 2 Inertia]
  - L2-03 [Minimum Baseblock Time]
  - L3-24 [Motor Accel Time @ Rated Torque]
  - n5-02 [Motor Inertia Acceleration Time]

### ■ C6-02: Carrier Frequency Selection

No. (Hex.)	Name	Description	Default (Range)
C6-02 (0224)	Carrier Frequency Selection	<div style="display: flex; gap: 5px;"> <span>V/f</span> <span>CL-V/f</span> <span>OLV</span> <span>CLV</span> <span>AOLV</span> <span>OLV/PM</span> <span>AOLV/PM</span> <span>CLV/PM</span> <span>EZOLV</span> </div> Sets the carrier frequency for the transistors in the drive.	Determined by A1-02, C6-01, and o2-04 (Determined by A1-02)

Changes to the switching frequency will decrease audible noise and decrease leakage current.

**Note:**

Increasing the carrier frequency to more than the default setting will automatically decrease the drive current rating.

**1 : 2.0 kHz**

**2 : 5.0 kHz (4.0 kHz for AOLV/PM)**

**3 : 8.0 kHz (6.0 kHz for AOLV/PM)**

**4 : 10.0 kHz (8.0 kHz for AOLV/PM)**

**5 : 12.5 kHz (10.0 kHz for AOLV/PM)**

**6 : 15.0 kHz (12.0 kHz AOLV/PM)**

**7 : Swing PWM1 (Audible Sound 1)**

**8 : Swing PWM2 (Audible Sound 2)**

**9 : Swing PWM3 (Audible Sound 3)**

**A : Swing PWM4 (Audible Sound 4)**

**F : User Defined (C6-03 to C6-05)**

Use *C6-03* to *C6-05* to set detailed setting values.

**Note:**

The carrier frequency for Swing PWM 1 is equivalent to 2.0 kHz. Swing PWM applies a special PWM pattern to decrease the audible noise.

**Table 11.40 Guidelines for Carrier Frequency Parameter Setup**

Symptom	Remedy
Speed and torque are not stable at low speed.	Decrease the carrier frequency.
Audible noise from the drive has an effect on peripheral devices.	Decrease the carrier frequency.
Too much leakage current from the drive.	Decrease the carrier frequency.

Symptom	Remedy
Wiring between the drive and motor is too long.	Decrease the carrier frequency. <b>Note:</b> If the motor cable is too long, it can be necessary to decrease the carrier frequency. Refer to <a href="#">Table 11.41</a> for the wiring distance and decrease the carrier frequency.
Audible motor noise is too loud.	Increase the carrier frequency. Use Swing PWM. <b>Note:</b> The default carrier frequency in ND is Swing PWM 1 ( $C6-02 = 7$ ), with a 2 kHz base. You can increase the carrier frequency in Normal Duty mode, but this will also decrease the drive rated current.

Table 11.41 Wiring Distance

Wiring Distance	Up to 50 m	Up to 100 m	Greater than 100 m
C6-02 [Carrier Frequency Selection]	1 to F (up to 15 kHz)	1 to 2 (up to 5 kHz), 7	1 (up to 2 kHz), 7

**Note:**

The maximum cable length is 100 m when using  $A1-02 = 5$  or  $6$  [Control Method Selection = OLV/PM or AOLV/PM].

### ■ C6-03: Carrier Frequency Upper Limit

No. (Hex.)	Name	Description	Default (Range)
C6-03 (0225)	Carrier Frequency Upper Limit	<div style="display: flex; justify-content: space-between; font-size: small;"> <span>V/f</span> <span>CL-V/f</span> <span>OLV</span> <span>CLV</span> <span>AOLV</span> <span>OLV/PM</span> <span>AOLV/PM</span> <span>CLV/PM</span> <span>EZOLV</span> </div> Sets the upper limit of the carrier frequency. Set $C6-02 = F$ [Carrier Frequency Selection = User Defined (C6-03 to C6-05)] to set this parameter.	Determined by C6-02 (1.0 - 15.0 kHz)

#### Setting a Fixed User-Defined Carrier Frequency

When you cannot use  $C6-02$  to set a carrier frequency between set selectable values, you can set the value in  $C6-03$ . The carrier frequency will be fixed to the value set to  $C6-03$ .

When  $A1-02 = 0, 1$  [Control Method Selection = V/f Control, V/f Control with Encoder], set  $C6-03 = C6-04$  [Carrier Frequency Lower Limit] to fix the carrier frequency.

#### Setting a Variable Carrier Frequency to Agree with the Output Frequency

When  $A1-02 = 0, 1$ , set  $C6-03$ ,  $C6-04$ , and  $C6-05$  [Carrier Freq Proportional Gain] as shown in [Figure 11.59](#) to make the carrier frequency change linearly with the output frequency.

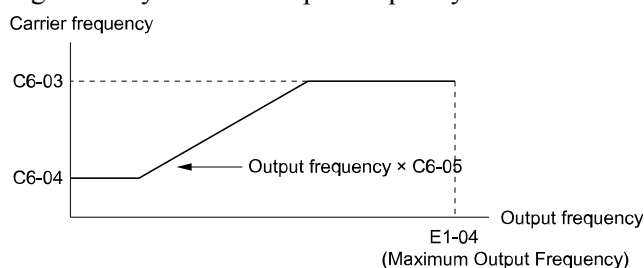


Figure 11.59 Setting a Variable Carrier Frequency to Agree with the Output Frequency

**Note:**

- When  $C6-05 \leq 7$ , the drive disables  $C6-04$ . The carrier frequency is fixed to the value set to  $C6-03$ .
- The drive detects *oPE11* [Carrier Frequency Setting Error] when these conditions are correct at the same time:
  - $C6-05 \geq 6$
  - $C6-04 \geq C6-03$

### ■ C6-04: Carrier Frequency Lower Limit

No. (Hex.)	Name	Description	Default (Range)
C6-04 (0226)	Carrier Frequency Lower Limit	<div style="display: flex; justify-content: space-between; font-size: small;"> <span>V/f</span> <span>CL-V/f</span> <span>OLV</span> <span>CLV</span> <span>AOLV</span> <span>OLV/PM</span> <span>AOLV/PM</span> <span>CLV/PM</span> <span>EZOLV</span> </div> Sets the lower limit of the carrier frequency. Set $C6-02 = F$ [Carrier Frequency Selection = User Defined (C6-03 to C6-05)] to set this parameter.	Determined by C6-02 (1.0 - 15.0 kHz)

## 11.4 C: Tuning

Set *C6-03 [Carrier Frequency Upper Limit]*, *C6-04*, and *C6-05 [Carrier Freq Proportional Gain]* to make the carrier frequency change linearly with the output frequency.

**Note:**

The drive detects *oPE11 [Carrier Frequency Setting Error]* when these conditions are correct at the same time:

- $C6-04 \geq C6-03$
- $C6-05 \geq 6$

### ■ C6-05: Carrier Freq Proportional Gain

No. (Hex.)	Name	Description	Default (Range)
C6-05 (0227)	Carrier Freq Proportional Gain	<div style="display: flex; justify-content: space-between; font-size: small;"> <span>V/f</span> <span>CL-V/f</span> <span>OLV</span> <span>CLV</span> <span>AOLV</span> <span>OLV/PM</span> <span>AOLV/PM</span> <span>CLV/PM</span> <span>EZOLV</span> </div> <p>Sets the proportional gain for the carrier frequency. Set <math>C6-02 = F</math> [<i>Carrier Frequency Selection = User Defined (C6-03 to C6-05)</i>] to set this parameter.</p>	Determined by C6-02 (0 - 99)

Set *C6-03 [Carrier Frequency Upper Limit]*, *C6-04 [Carrier Frequency Lower Limit]*, and *C6-05* to make the carrier frequency change linearly with the output frequency.

### ■ C6-09: Carrier Freq at Rotational Tune

No. (Hex.)	Name	Description	Default (Range)
C6-09 (022B)	Carrier Freq at Rotational Tune	<div style="display: flex; justify-content: space-between; font-size: small;"> <span>V/f</span> <span>CL-V/f</span> <span>OLV</span> <span>CLV</span> <span>AOLV</span> <span>OLV/PM</span> <span>AOLV/PM</span> <span>CLV/PM</span> <span>EZOLV</span> </div> <p>Sets the Auto-Tuning carrier frequency. Usually it is not necessary to change this setting.</p>	0 (0, 1)

If you do Auto-Tuning to a high-frequency motor or low-impedance motor and set a low carrier frequency, *oC [Overcurrent]* can occur. To prevent *oC*, you can set the carrier frequency to a high value, then set  $C6-09 = 1$ .

The procedure to set the carrier frequency when the *A1-02 [Control Method Selection]* setting changes.

- When  $A1-02 = 2$  to  $4$  [*OLV, CLV, or AOLV*], set  $C6-02 = F$  [*Carrier Frequency Selection = User Defined (C6-03 to C6-05)*] and then increase the value set to *C6-03 [Carrier Frequency Upper Limit]*.
- When  $A1-02 = 5$  to  $7$  [*OLV/PM, AOLV/PM, or CLV/PM*], use *C6-02* to increase the carrier frequency.

#### 0 : 5kHz

**Note:**

When  $A1-02 = 5, 6, \text{ or } 7$ , the carrier frequency is 2 kHz.

#### 1 : use C6-03

**Note:**

When  $A1-02 = 5, 6, \text{ or } 7$ , the carrier frequency is the value set to *C6-02*.

## 11.5 d: References

*d* parameters [References] set the frequency reference input method and dead band range. They also set torque control, field weakening, and field forcing functions.

**WARNING! Sudden Movement Hazard.** Always check the operation of any fast stop circuits after they are wired. Fast stop circuits are required to provide safe and quick shutdown of the drive. Prepare to initiate an emergency stop during the test run. Operating a drive with untested emergency circuits could result in death or serious injury.

**WARNING! Crush Hazard.** Do not use this drive in lifting applications without installing external safety circuitry to prevent accidental dropping of the load. The drive does not possess built-in load drop protection for lifting applications. Install electrical and/or mechanical safety circuit mechanisms independent of drive circuitry. Failure to comply could result in death or serious injury from falling loads.

### ◆ d1: Frequency Reference

Figure 11.60 shows the frequency reference input method, command source selection method and priority descriptions.

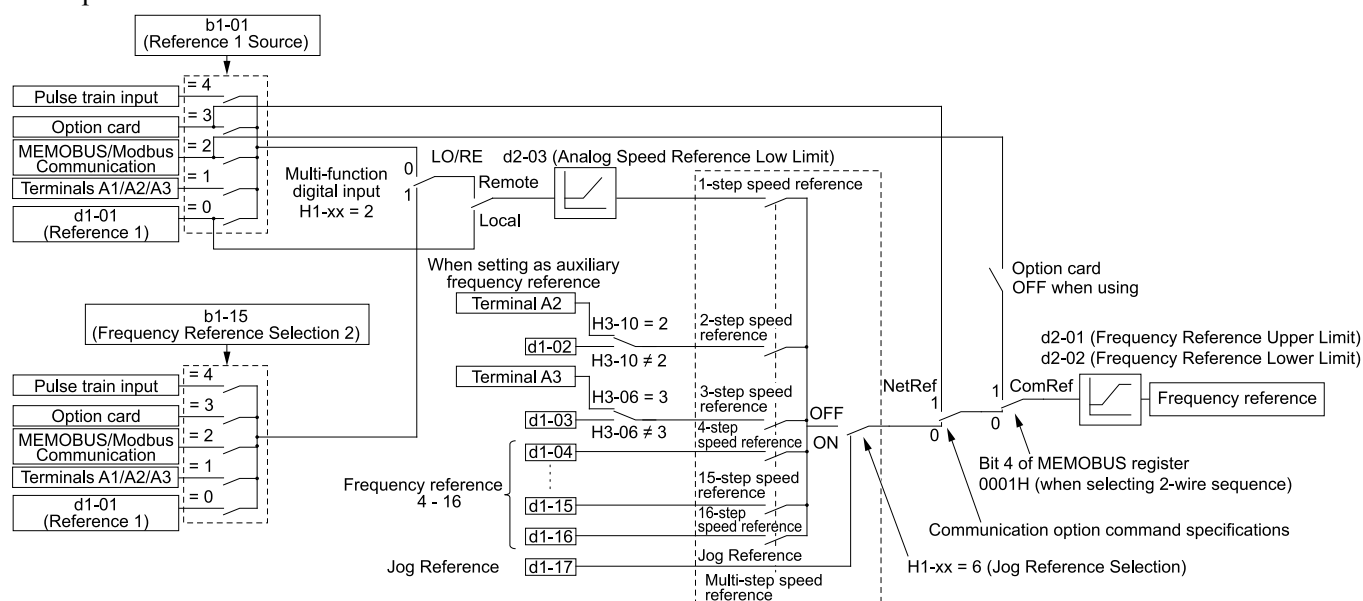


Figure 11.60 Frequency Reference Setting Hierarchy

### ■ Multi-Step Speed Operation

The drive has a multi-step speed operation function that can set many frequency references in advance. Set frequency references in *d1-xx* parameters. You can select the set frequency references with MFDI signals from an external source. Activate and deactivate the digital input to select the frequency reference to change the motor speed in steps. You can use the 16-step frequency reference and one Jog Frequency Reference (JOG command) to switch the speed to the maximum 17-step speeds.

#### Note:

- The Jog Frequency Reference (JOG command) overrides all other frequency references.
- You can use the MFDI to switch the frequency reference when the motor is running. The drive will apply the enabled acceleration and deceleration times.
- The default settings for Multi-Step Speed Reference 1 (master frequency reference) and Multi-Step Speed Reference 2 (auxiliary frequency reference) are the analog frequency reference. Also, voltage command input terminal A1 and current input terminal A2 for Multi-Step Speed Reference 1 (master frequency reference) are added internally by default. The drive uses Multi-Step Speed Reference 1 when the signal is connected to an analog input terminal.

### ■ Setting Procedures for Multi-step Speed Operation

#### Use an Analog Input as Reference 1 and 2

This section gives information about the procedures to set these examples:

- Multi-Step Speed 6 (6 types of frequency references)
- When you set the voltage input of analog inputs from terminals A1 and A3 to -10 V to +10 V

Procedure	Configuration Parameter	Task Contents
1	Reference 1	<ol style="list-style-type: none"> <li>Sets <math>b1-01 = 1</math> [Frequency Reference Selection 1 = Analog Input].</li> <li>Sets <math>H3-02 = 0</math> [Terminal A1 Function Selection = Frequency Reference].</li> <li>Sets <math>H3-01 = 1</math> [Terminal A1 Signal Level Select = -10 to +10V (Bipolar Reference)].</li> </ol>
2	Reference 2	<ol style="list-style-type: none"> <li>Sets <math>H3-06 = 2</math> [Terminal A3 Function Selection = Auxiliary Frequency Reference 1].</li> <li>Sets <math>H3-05 = 1</math> [Terminal A3 Signal Level Select = -10 to +10V (Bipolar Reference)].</li> </ol>
3	Signal type of analog input	Set DIP switches $S1-1$ and $S1-3$ on the control circuit board to the V-side (voltage). <b>Note:</b> Set this before you energize the drive.
4	Reference 3	Sets the value of $d1-03$ [Reference 3].
5	Reference 4	Sets the value of $d1-04$ [Reference 4].
6	Reference 5	Sets the value of $d1-05$ [Reference 5].
7	Jog Reference	Sets $d1-17$ [Jog Reference] to the jog speed.
8	External digital input (3 inputs)	Set the Multi-Step Speed Reference 1 to 3 [ $H1-xx = 3, 4, 5$ ] to one of the MFDI terminals S1 to S8.
9	JOG command	Set the Jog Reference Selection [ $H1-xx = 6$ ] to one of the MFDI terminals S1 to S8.

**Use the Maximum 17-Step Speed with All Digital Inputs**

This section is the procedure to set the 17-step speeds (17 types of frequency references) without an analog input.

Procedure	Configuration Parameter	Task Contents
1	Reference 1	<ol style="list-style-type: none"> <li>Set <math>b1-01 = 0</math> [Frequency Reference Selection 1 = Keypad].</li> <li>Sets the value of <math>d1-01</math> [Reference 1].</li> </ol>
2	Reference 2	<ol style="list-style-type: none"> <li>Sets <math>H3-06 = F</math> [Terminal A3 Function Selection = Not Used], and disables the analog reference.</li> <li>Set <math>d1-02</math> [Reference 2].</li> </ol>
3	Reference 3	<ol style="list-style-type: none"> <li>Sets <math>H3-10 = F</math> [Terminal A2 Function Selection = Not Used], and disables the analog reference.</li> <li>Set <math>d1-03</math> [Reference 3].</li> </ol>
4	Reference 4	Set $d1-04$ [Reference 4].
5	Reference 5 to 16	Sets the values of $d1-05$ to $d1-16$ [Reference 5 to 16].
6	Jog Reference	Sets $d1-17$ [Jog Reference] to the jog speed.
7	External digital input (4 inputs)	Set Multi-Step Speed Reference 1 to 4 [ $H1-xx = 3, 4, 5, 32$ ] to one of the multi-function digital input terminals S1 to S8.
8	JOG command	Set the Jog Reference Selection [ $H1-xx = 6$ ] to one of the multi-function digital input terminals S1 to S8.

**Multi-step Speed Operation Combinations**

Refer to [Table 11.42](#) and [Figure 11.61](#) for information about multi-step speed reference combinations. The selected frequency reference changes when the combination of digital input signals from an external source changes.

**Table 11.42 Multi-step Speed Reference and MFDI Terminal Combinations**

Related Parameters	Multi-Step Speed Reference 1 $H1-xx = 3$	Multi-Step Speed Reference 2 $H1-xx = 4$	Multi-Step Speed Reference 3 $H1-xx = 5$	Multi-Step Speed Reference 4 $H1-xx = 32$	Jog Reference Selection $H1-xx = 6$
Reference 1 (set in $b1-01$ )	OFF	OFF	OFF	OFF	OFF
Reference 2 ( $d1-02$ or terminals A1, A2, A3)	ON	OFF	OFF	OFF	OFF
Reference 3 ( $d1-03$ or terminals A1, A2, A3)	OFF	ON	OFF	OFF	OFF
Reference 4 ( $d1-04$ )	ON	ON	OFF	OFF	OFF
Reference 5 ( $d1-05$ )	OFF	OFF	ON	OFF	OFF



Related Parameters	Multi-Step Speed Reference 1 H1-xx = 3	Multi-Step Speed Reference 2 H1-xx = 4	Multi-Step Speed Reference 3 H1-xx = 5	Multi-Step Speed Reference 4 H1-xx = 32	Jog Reference Selection H1-xx = 6
Reference 6 (d1-06)	ON	OFF	ON	OFF	OFF
Reference 7 (d1-07)	OFF	ON	ON	OFF	OFF
Reference 8 (d1-08)	ON	ON	ON	OFF	OFF
Reference 9 (d1-09)	OFF	OFF	OFF	ON	OFF
Reference 10 (d1-10)	ON	OFF	OFF	ON	OFF
Reference 11 (d1-11)	OFF	ON	OFF	ON	OFF
Reference 12 (d1-12)	ON	ON	OFF	ON	OFF
Reference 13 (d1-13)	OFF	OFF	ON	ON	OFF
Reference 14 (d1-14)	ON	OFF	ON	ON	OFF
Reference 15 (d1-15)	OFF	ON	ON	ON	OFF
Reference 16 (d1-16)	ON	ON	ON	ON	OFF
Jog Reference (d1-17)*1	-	-	-	-	ON

\*1 Jog Reference (JOG command) is more important than all other frequency references.

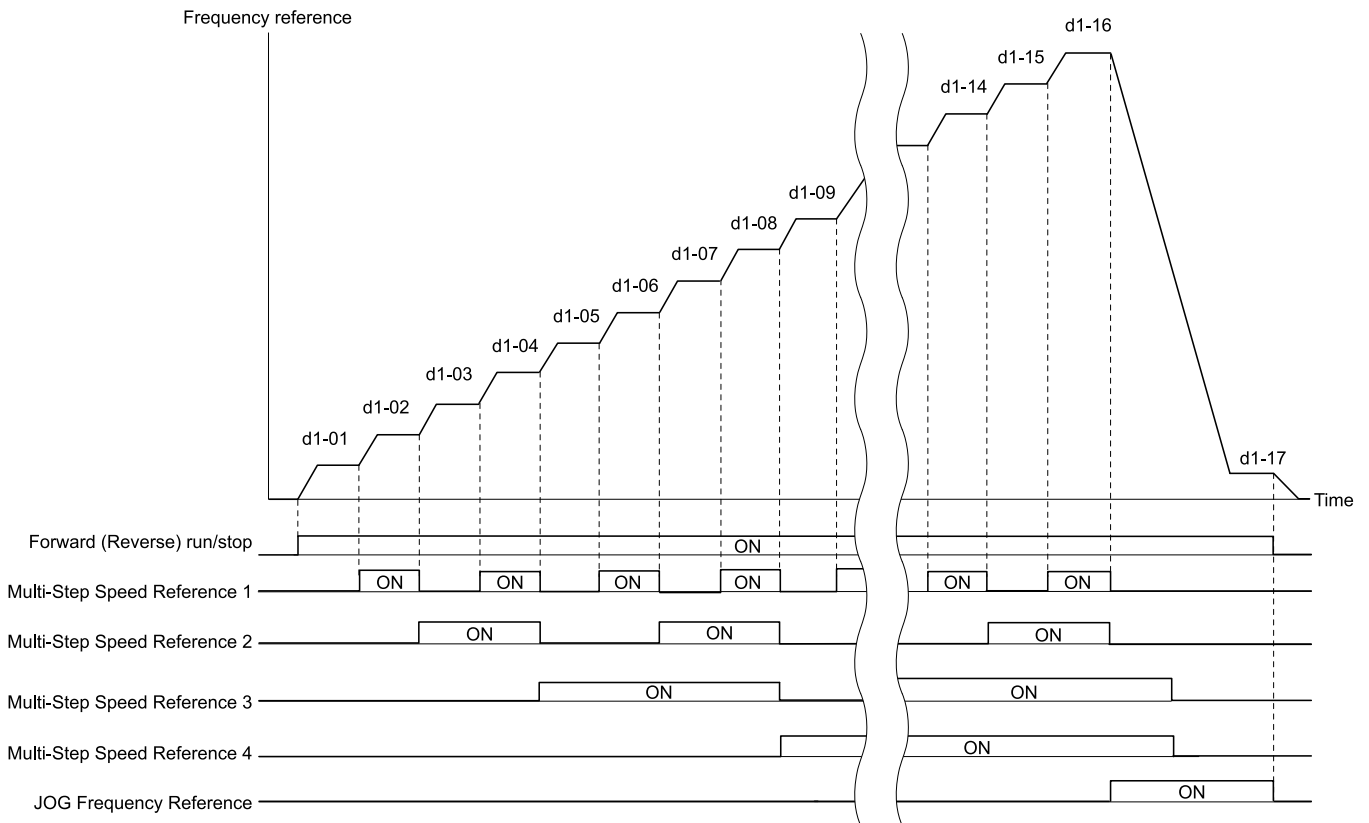


Figure 11.61 Time Chart for Multi-step Speed Reference/JOG Reference

■ d1-01: Reference 1

No. (Hex.)	Name	Description	Default (Range)
d1-01 (0280) RUN	Reference 1	<span style="background-color: #cccccc; padding: 2px;">V/f</span> <span style="background-color: #cccccc; padding: 2px;">CL-V/f</span> <span style="background-color: #cccccc; padding: 2px;">OLV</span> <span style="background-color: #cccccc; padding: 2px;">CLV</span> <span style="background-color: #cccccc; padding: 2px;">AOLV</span> <span style="background-color: #cccccc; padding: 2px;">OLV/PM</span> <span style="background-color: #cccccc; padding: 2px;">AOLV/PM</span> <span style="background-color: #cccccc; padding: 2px;">CLV/PM</span> <span style="background-color: #cccccc; padding: 2px;">EZOLV</span> Sets the frequency reference in the units from <i>o1-03</i> [Frequency Display Unit Selection].	0.00 Hz (0.00 - 590.00 Hz)

**Note:**

- The upper limit value changes when the *E1-04 [Maximum Output Frequency]* and *d2-01 [Frequency Reference Upper Limit]* values change. Calculate the upper limit value with this formula:  
Upper limit value =  $(E1-04) \times (d2-01) / 100$
- When *A1-02 = 6, 7 [Control Method Selection = PM Advanced Open Loop Vector, PM Closed Loop Vector]*, the drive changes *o1-03 = 1 [0.01% (100% = E1-04)]*.
- To set *d1-01* to 1-step speed parameter in a multi-step speed operation, set *b1-01 = 0 [Frequency Reference Selection 1 = Keypad]*.

■ **d1-02: Reference 2**

No. (Hex.)	Name	Description	Default (Range)
d1-02 (0281) RUN	Reference 2	<b>V/f</b> <b>CL-V/f</b> <b>OLV</b> <b>CLV</b> <b>AOLV</b> <b>OLV/PM</b> <b>AOLV/PM</b> <b>CLV/PM</b> <b>EZOLV</b> Sets the frequency reference in the units from <i>o1-03 [Frequency Display Unit Selection]</i> .	0.00 Hz (0.00 - 590.00 Hz)

**Note:**

- The upper limit value changes when the *E1-04 [Maximum Output Frequency]* and *d2-01 [Frequency Reference Upper Limit]* values change.
- When *A1-02 = 6, 7 [Control Method Selection = PM Advanced Open Loop Vector, PM Closed Loop Vector]*, the drive changes *o1-03 = 1 [0.01% (100% = E1-04)]*.
- To set *d1-02* to Multi-Step Speed 2, set *H3-02, H3-06, and H3-10 ≠ 2 [MFAI Function Select ≠ Auxiliary Frequency Reference 1]*. When the status is the default setting, set *H3-06 = F [Terminal A3 Function Selection = Not Used]*.

■ **d1-03: Reference 3**

No. (Hex.)	Name	Description	Default (Range)
d1-03 (0282) RUN	Reference 3	<b>V/f</b> <b>CL-V/f</b> <b>OLV</b> <b>CLV</b> <b>AOLV</b> <b>OLV/PM</b> <b>AOLV/PM</b> <b>CLV/PM</b> <b>EZOLV</b> Sets the frequency reference in the units from <i>o1-03 [Keypad Display Selection]</i> .	0.00 Hz (0.00 - 590.00 Hz)

**Note:**

- The upper limit value changes when the *E1-04 [Maximum Output Frequency]* and *d2-01 [Frequency Reference Upper Limit]* values change.
- When *A1-02 = 6, 7 [Control Method Selection = PM Advanced Open Loop Vector, PM Closed Loop Vector]*, the drive changes *o1-03 = 1 [0.01% (100% = E1-04)]*.
- To set *d1-03* to Multi-Step Speed 3, set *H3-02, H3-06, and H3-10 ≠ 3 [MFAI Function Select ≠ Auxiliary Frequency Reference 2]*.

■ **d1-04: Reference 4**

No. (Hex.)	Name	Description	Default (Range)
d1-04 (0283) RUN	Reference 4	<b>V/f</b> <b>CL-V/f</b> <b>OLV</b> <b>CLV</b> <b>AOLV</b> <b>OLV/PM</b> <b>AOLV/PM</b> <b>CLV/PM</b> <b>EZOLV</b> Sets the frequency reference in the units from <i>o1-03 [Frequency Display Unit Selection]</i> .	0.00 Hz (0.00 - 590.00 Hz)

**Note:**

- The upper limit value changes when the *E1-04 [Maximum Output Frequency]* and *d2-01 [Frequency Reference Upper Limit]* values change.
- When *A1-02 = 6, 7 [Control Method Selection = PM Advanced Open Loop Vector, PM Closed Loop Vector]*, the drive changes *o1-03 = 1 [0.01% (100% = E1-04)]*.
- This parameter sets the frequency reference of Multi-Step Speed 4.

■ **d1-05: Reference 5**

No. (Hex.)	Name	Description	Default (Range)
d1-05 (0284) RUN	Reference 5	<b>V/f</b> <b>CL-V/f</b> <b>OLV</b> <b>CLV</b> <b>AOLV</b> <b>OLV/PM</b> <b>AOLV/PM</b> <b>CLV/PM</b> <b>EZOLV</b> Sets the frequency reference in the units from <i>o1-03 [Frequency Display Unit Selection]</i> .	0.00 Hz (0.00 - 590.00 Hz)

**Note:**

- The upper limit value changes when the *E1-04 [Maximum Output Frequency]* and *d2-01 [Frequency Reference Upper Limit]* values change.
- When *A1-02 = 6, 7 [Control Method Selection = PM Advanced Open Loop Vector, PM Closed Loop Vector]*, the drive changes *o1-03 = 1 [0.01% (100% = E1-04)]*.
- This parameter sets the frequency reference of Multi-Step Speed 5.

### ■ d1-06: Reference 6

No. (Hex.)	Name	Description	Default (Range)
d1-06 (0285) RUN	Reference 6	<div style="display: flex; justify-content: space-between; font-size: 0.8em; font-weight: bold; margin-bottom: 5px;"> <span>V/f</span> <span>CL-V/f</span> <span>OLV</span> <span>CLV</span> <span>AOLV</span> <span>OLV/PM</span> <span>AOLV/PM</span> <span>CLV/PM</span> <span>EZOLV</span> </div> Sets the frequency reference in the units from <i>o1-03 [Frequency Display Unit Selection]</i> .	0.00 Hz (0.00 - 590.00 Hz)

**Note:**

- The upper limit value changes when the *E1-04 [Maximum Output Frequency]* and *d2-01 [Frequency Reference Upper Limit]* values change.
- When *A1-02 = 6, 7 [Control Method Selection = PM Advanced Open Loop Vector, PM Closed Loop Vector]*, the drive changes *o1-03 = 1 [0.01% (100% = E1-04)]*.
- This parameter sets the frequency reference of Multi-Step Speed 6.

### ■ d1-07: Reference 7

No. (Hex.)	Name	Description	Default (Range)
d1-07 (0286) RUN	Reference 7	<div style="display: flex; justify-content: space-between; font-size: 0.8em; font-weight: bold; margin-bottom: 5px;"> <span>V/f</span> <span>CL-V/f</span> <span>OLV</span> <span>CLV</span> <span>AOLV</span> <span>OLV/PM</span> <span>AOLV/PM</span> <span>CLV/PM</span> <span>EZOLV</span> </div> Sets the frequency reference in the units from <i>o1-03 [Frequency Display Unit Selection]</i> .	0.00 Hz (0.00 - 590.00 Hz)

**Note:**

- The upper limit value changes when the *E1-04 [Maximum Output Frequency]* and *d2-01 [Frequency Reference Upper Limit]* values change.
- When *A1-02 = 6, 7 [Control Method Selection = PM Advanced Open Loop Vector, PM Closed Loop Vector]*, the drive changes *o1-03 = 1 [0.01% (100% = E1-04)]*.
- This parameter sets the frequency reference of Multi-Step Speed 7.

### ■ d1-08: Reference 8

No. (Hex.)	Name	Description	Default (Range)
d1-08 (0287) RUN	Reference 8	<div style="display: flex; justify-content: space-between; font-size: 0.8em; font-weight: bold; margin-bottom: 5px;"> <span>V/f</span> <span>CL-V/f</span> <span>OLV</span> <span>CLV</span> <span>AOLV</span> <span>OLV/PM</span> <span>AOLV/PM</span> <span>CLV/PM</span> <span>EZOLV</span> </div> Sets the frequency reference in the units from <i>o1-03 [Frequency Display Unit Selection]</i> .	0.00 Hz (0.00 - 590.00 Hz)

**Note:**

- The upper limit value changes when the *E1-04 [Maximum Output Frequency]* and *d2-01 [Frequency Reference Upper Limit]* values change.
- When *A1-02 = 6, 7 [Control Method Selection = PM Advanced Open Loop Vector, PM Closed Loop Vector]*, the drive changes *o1-03 = 1 [0.01% (100% = E1-04)]*.
- This parameter sets the frequency reference of Multi-Step Speed 8.

### ■ d1-09: Reference 9

No. (Hex.)	Name	Description	Default (Range)
d1-09 (0288) RUN	Reference 9	<div style="display: flex; justify-content: space-between; font-size: 0.8em; font-weight: bold; margin-bottom: 5px;"> <span>V/f</span> <span>CL-V/f</span> <span>OLV</span> <span>CLV</span> <span>AOLV</span> <span>OLV/PM</span> <span>AOLV/PM</span> <span>CLV/PM</span> <span>EZOLV</span> </div> Sets the frequency reference in the units from <i>o1-03 [Frequency Display Unit Selection]</i> .	0.00 Hz (0.00 - 590.00 Hz)

**Note:**

- The upper limit value changes when the *E1-04 [Maximum Output Frequency]* and *d2-01 [Frequency Reference Upper Limit]* values change.
- When *A1-02 = 6, 7 [Control Method Selection = PM Advanced Open Loop Vector, PM Closed Loop Vector]*, the drive changes *o1-03 = 1 [0.01% (100% = E1-04)]*.
- This parameter sets the frequency reference of Multi-Step Speed 9.

### ■ d1-10: Reference 10

No. (Hex.)	Name	Description	Default (Range)
d1-10 (028B) RUN	Reference 10	<div style="display: flex; justify-content: space-between; font-size: 0.8em; font-weight: bold; background-color: #f0f0f0; padding: 2px;"> <span>V/f</span> <span>CL-V/f</span> <span>OLV</span> <span>CLV</span> <span>AOLV</span> <span>OLV/PM</span> <span>AOLV/PM</span> <span>CLV/PM</span> <span>EZOLV</span> </div> Sets the frequency reference in the units from <i>o1-03</i> [Frequency Display Unit Selection].	0.00 Hz (0.00 - 590.00 Hz)

**Note:**

- The upper limit value changes when the *E1-04* [Maximum Output Frequency] and *d2-01* [Frequency Reference Upper Limit] values change.
- When *A1-02* = 6, 7 [Control Method Selection = PM Advanced Open Loop Vector, PM Closed Loop Vector], the drive changes *o1-03* = 1 [0.01% (100% = *E1-04*)].
- This parameter sets the frequency reference of Multi-Step Speed 10.

### ■ d1-11: Reference 11

No. (Hex.)	Name	Description	Default (Range)
d1-11 (028C) RUN	Reference 11	<div style="display: flex; justify-content: space-between; font-size: 0.8em; font-weight: bold; background-color: #f0f0f0; padding: 2px;"> <span>V/f</span> <span>CL-V/f</span> <span>OLV</span> <span>CLV</span> <span>AOLV</span> <span>OLV/PM</span> <span>AOLV/PM</span> <span>CLV/PM</span> <span>EZOLV</span> </div> Sets the frequency reference in the units from <i>o1-03</i> [Frequency Display Unit Selection].	0.00 Hz (0.00 - 590.00 Hz)

**Note:**

- The upper limit value changes when the *E1-04* [Maximum Output Frequency] and *d2-01* [Frequency Reference Upper Limit] values change.
- When *A1-02* = 6, 7 [Control Method Selection = PM Advanced Open Loop Vector, PM Closed Loop Vector], the drive changes *o1-03* = 1 [0.01% (100% = *E1-04*)].
- This parameter sets the frequency reference of Multi-Step Speed 11.

### ■ d1-12: Reference 12

No. (Hex.)	Name	Description	Default (Range)
d1-12 (028D) RUN	Reference 12	<div style="display: flex; justify-content: space-between; font-size: 0.8em; font-weight: bold; background-color: #f0f0f0; padding: 2px;"> <span>V/f</span> <span>CL-V/f</span> <span>OLV</span> <span>CLV</span> <span>AOLV</span> <span>OLV/PM</span> <span>AOLV/PM</span> <span>CLV/PM</span> <span>EZOLV</span> </div> Sets the frequency reference in the units from <i>o1-03</i> [Frequency Display Unit Selection].	0.00 Hz (0.00 - 590.00 Hz)

**Note:**

- The upper limit value changes when the *E1-04* [Maximum Output Frequency] and *d2-01* [Frequency Reference Upper Limit] values change.
- When *A1-02* = 6, 7 [Control Method Selection = PM Advanced Open Loop Vector, PM Closed Loop Vector], the drive changes *o1-03* = 1 [0.01% (100% = *E1-04*)].
- This parameter sets the frequency reference of Multi-Step Speed 12.

### ■ d1-13: Reference 13

No. (Hex.)	Name	Description	Default (Range)
d1-13 (028E) RUN	Reference 13	<div style="display: flex; justify-content: space-between; font-size: 0.8em; font-weight: bold; background-color: #f0f0f0; padding: 2px;"> <span>V/f</span> <span>CL-V/f</span> <span>OLV</span> <span>CLV</span> <span>AOLV</span> <span>OLV/PM</span> <span>AOLV/PM</span> <span>CLV/PM</span> <span>EZOLV</span> </div> Sets the frequency reference in the units from <i>o1-03</i> [Frequency Display Unit Selection].	0.00 Hz (0.00 - 590.00 Hz)

**Note:**

- The upper limit value changes when the *E1-04* [Maximum Output Frequency] and *d2-01* [Frequency Reference Upper Limit] values change.
- When *A1-02* = 6, 7 [Control Method Selection = PM Advanced Open Loop Vector, PM Closed Loop Vector], the drive changes *o1-03* = 1 [0.01% (100% = *E1-04*)].
- This parameter sets the frequency reference of Multi-Step Speed 13.

### ■ d1-14: Reference 14

No. (Hex.)	Name	Description	Default (Range)
d1-14 (028F) RUN	Reference 14	<b>V/f</b> <b>CL-V/f</b> <b>OLV</b> <b>CLV</b> <b>AOLV</b> <b>OLV/PM</b> <b>AOLV/PM</b> <b>CLV/PM</b> <b>EZOLV</b> Sets the frequency reference in the units from <i>o1-03</i> [Frequency Display Unit Selection].	0.00 Hz (0.00 - 590.00 Hz)

**Note:**

- The upper limit value changes when the *E1-04* [Maximum Output Frequency] and *d2-01* [Frequency Reference Upper Limit] values change.
- When *A1-02* = 6, 7 [Control Method Selection = PM Advanced Open Loop Vector, PM Closed Loop Vector], the drive changes *o1-03* = 1 [0.01% (100% = *E1-04*)].
- This parameter sets the frequency reference of Multi-Step Speed 14.

### ■ d1-15: Reference 15

No. (Hex.)	Name	Description	Default (Range)
d1-15 (0290) RUN	Reference 15	<b>V/f</b> <b>CL-V/f</b> <b>OLV</b> <b>CLV</b> <b>AOLV</b> <b>OLV/PM</b> <b>AOLV/PM</b> <b>CLV/PM</b> <b>EZOLV</b> Sets the frequency reference in the units from <i>o1-03</i> [Frequency Display Unit Selection].	0.00 Hz (0.00 - 590.00 Hz)

**Note:**

- The upper limit value changes when the *E1-04* [Maximum Output Frequency] and *d2-01* [Frequency Reference Upper Limit] values change.
- When *A1-02* = 6, 7 [Control Method Selection = PM Advanced Open Loop Vector, PM Closed Loop Vector], the drive changes *o1-03* = 1 [0.01% (100% = *E1-04*)].
- This parameter sets the frequency reference of Multi-Step Speed 15.

### ■ d1-16: Reference 16

No. (Hex.)	Name	Description	Default (Range)
d1-16 (0291) RUN	Reference 16	<b>V/f</b> <b>CL-V/f</b> <b>OLV</b> <b>CLV</b> <b>AOLV</b> <b>OLV/PM</b> <b>AOLV/PM</b> <b>CLV/PM</b> <b>EZOLV</b> Sets the frequency reference in the units from <i>o1-03</i> [Frequency Display Unit Selection].	0.00 Hz (0.00 - 590.00 Hz)

**Note:**

- The upper limit value changes when the *E1-04* [Maximum Output Frequency] and *d2-01* [Frequency Reference Upper Limit] values change.
- When *A1-02* = 6, 7 [Control Method Selection = PM Advanced Open Loop Vector, PM Closed Loop Vector], the drive changes *o1-03* = 1 [0.01% (100% = *E1-04*)].
- This parameter sets the frequency reference of Multi-Step Speed 16.

### ■ d1-17: Jog Reference

No. (Hex.)	Name	Description	Default (Range)
d1-17 (0292) RUN	Jog Reference	<b>V/f</b> <b>CL-V/f</b> <b>OLV</b> <b>CLV</b> <b>AOLV</b> <b>OLV/PM</b> <b>AOLV/PM</b> <b>CLV/PM</b> <b>EZOLV</b> Sets the JOG frequency reference in the units from <i>o1-03</i> [Frequency Display Unit Selection]. Set <i>H1-xx</i> = 6 [MF/DFI Function Select = Jog Reference Selection] to use the Jog frequency reference.	6.00 Hz (0.00 - 590.00 Hz)

**Note:**

- The upper limit value changes when the *E1-04* [Maximum Output Frequency] and *d2-01* [Frequency Reference Upper Limit] values change.
- When *A1-02* = 6, 7 [Control Method Selection = PM Advanced Open Loop Vector, PM Closed Loop Vector], the drive changes *o1-03* = 1 [0.01% (100% = *E1-04*)].

### ◆ d2: Reference Limits

*d2* parameters set the upper and lower frequency limits to control the motor speed. Apply these parameters to for example, run the motor at low-speed due to mechanical strength concerns, or if the motor should not be run at low speed because of lubrication issues with the gears and bearings.

The upper frequency limit is set in *d2-01* [*Frequency Reference Upper Limit*] and the lower limit is set in *d2-02* [*Frequency Reference Lower Limit*].

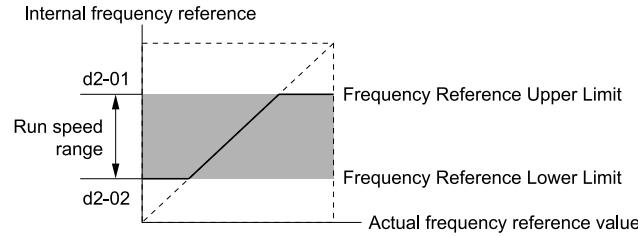


Figure 11.62 Upper and Lower Frequency Limits

■ **d2-01: Frequency Reference Upper Limit**

No. (Hex.)	Name	Description	Default (Range)
d2-01 (0289)	Frequency Reference Upper Limit	<b>V/f</b> <b>CL-V/f</b> <b>OLV</b> <b>CLV</b> <b>AOLV</b> <b>OLV/PM</b> <b>AOLV/PM</b> <b>CLV/PM</b> <b>EZOLV</b> Sets maximum limit for all frequency references. This value is a percentage of <i>E1-04</i> [ <i>Maximum Output Frequency</i> ].	100.0% (0.0 - 110.0%)

When the frequency reference is more than the value set in *d2-01* the drive will continue to operate at the value set in *d2-01*.

■ **d2-02: Frequency Reference Lower Limit**

No. (Hex.)	Name	Description	Default (Range)
d2-02 (028A)	Frequency Reference Lower Limit	<b>V/f</b> <b>CL-V/f</b> <b>OLV</b> <b>CLV</b> <b>AOLV</b> <b>OLV/PM</b> <b>AOLV/PM</b> <b>CLV/PM</b> <b>EZOLV</b> Sets minimum limit for all frequency references. This value is a percentage of <i>E1-04</i> [ <i>Maximum Output Frequency</i> ].	0.0% (0.0 - 110.0%)

When the frequency reference is less than the value set in *d2-02*, the drive will continue to operate at the value set in *d2-02*. The motor will accelerate to the *d2-02* value after the drive receives a Run command and a lower frequency reference than *d2-02* has been entered.

■ **d2-03: Analog Frequency Ref Lower Limit**

No. (Hex.)	Name	Description	Default (Range)
d2-03 (0293)	Analog Frequency Ref Lower Limit	<b>V/f</b> <b>CL-V/f</b> <b>OLV</b> <b>CLV</b> <b>AOLV</b> <b>OLV/PM</b> <b>AOLV/PM</b> <b>CLV/PM</b> <b>EZOLV</b> Sets the lower limit of the master frequency reference (Multi-Step Speed 1) as a percentage of <i>E1-04</i> [ <i>Maximum Output Frequency</i> ].	0.0% (0.0 - 110.0%)

This parameter does not change the lower limit of Jog reference, frequency reference for multi-step speed operation, or the auxiliary frequency reference.

The drive operates at the value set in *d2-03* when the frequency reference decreases to less than the value set in *d2-03*.

**Note:**

When lower limits are set to parameters *d2-02* [*Frequency Reference Lower Limit*] and *d2-03*, the drive uses the larger value as the lower limit.

◆ **d3: Jump Frequency**

The Jump frequency is a function that sets the dead band to a specified frequency band. If a machine that operated at constant speed is operated with variable speed, it can make resonance. To operate the machine without resonance from the natural frequency of the machinery mechanical system, use a frequency band jump.

You can program the drive to have three different Jump frequencies. Set *d3-01* to *d3-03* [*Jump Frequencies*] to the median value for the jumped frequency and set *d3-04* [*Jump Frequency Width*] to the Jump frequency width.

When you input a frequency reference that is the same as or near the Jump frequency width, the frequency reference changes automatically.

The drive accelerates or decelerates the motor smoothly until the frequency reference is not in the range of the Jump frequency band. The drive will use the active accel/decel time to go through the specified dead band range. If the frequency reference is not in the range of the Jump frequency band, switch to constant speed operation.

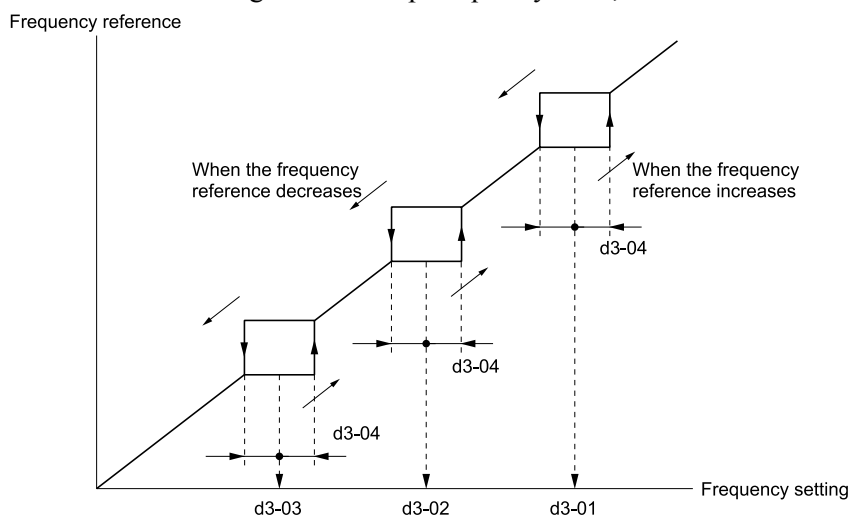


Figure 11.63 Jump Frequency

**Note:**

- When you set Jump Frequencies 1 to 3, make sure that the parameters do not overlap.
- When the drive is in the range of the Jump frequency, the frequency reference changes automatically. When Jump is executed, the output frequency changes smoothly as specified by the values set in C1-01 [Acceleration Time 1] and C1-02 [Deceleration Time 1].

### ■ d3-01: Jump Frequency 1

No. (Hex.)	Name	Description	Default (Range)
d3-01 (0294)	Jump Frequency 1	<input type="checkbox"/> V/f <input type="checkbox"/> CL-V/f <input type="checkbox"/> OLV <input type="checkbox"/> CLV <input type="checkbox"/> AOLV <input type="checkbox"/> OLV/PM <input type="checkbox"/> AOLV/PM <input type="checkbox"/> CLV/PM <input type="checkbox"/> EZOLV Sets the median value of the frequency band that the drive will avoid.	0.0 Hz (Determined by A1-02)

**Note:**

Set this parameter to 0.0 Hz to disable the Jump frequency.

### ■ d3-02: Jump Frequency 2

No. (Hex.)	Name	Description	Default (Range)
d3-02 (0295)	Jump Frequency 2	<input type="checkbox"/> V/f <input type="checkbox"/> CL-V/f <input type="checkbox"/> OLV <input type="checkbox"/> CLV <input type="checkbox"/> AOLV <input type="checkbox"/> OLV/PM <input type="checkbox"/> AOLV/PM <input type="checkbox"/> CLV/PM <input type="checkbox"/> EZOLV Sets the median value of the frequency band that the drive will avoid.	0.0 Hz (Determined by A1-02)

**Note:**

Set this parameter to 0.0 Hz to disable the Jump frequency.

### ■ d3-03: Jump Frequency 3

No. (Hex.)	Name	Description	Default (Range)
d3-03 (0296)	Jump Frequency 3	<input type="checkbox"/> V/f <input type="checkbox"/> CL-V/f <input type="checkbox"/> OLV <input type="checkbox"/> CLV <input type="checkbox"/> AOLV <input type="checkbox"/> OLV/PM <input type="checkbox"/> AOLV/PM <input type="checkbox"/> CLV/PM <input type="checkbox"/> EZOLV Sets the median value of the frequency band that the drive will avoid.	0.0 Hz (Determined by A1-02)

**Note:**

Set this parameter to 0.0 Hz to disable the Jump frequency.

### ■ d3-04: Jump Frequency Width

No. (Hex.)	Name	Description	Default (Range)
d3-04 (0297)	Jump Frequency Width	<b>V/f</b> <b>CL-V/f</b> <b>OLV</b> <b>CLV</b> <b>AOLV</b> <b>OLV/PM</b> <b>AOLV/PM</b> <b>CLV/PM</b> <b>EZOLV</b> Sets the width of the frequency band that the drive will avoid.	1.0 Hz (Determined by A1-02)

### ◆ d4: Frequency Ref Up/Down & Hold

The *d4 parameters* set the Frequency Reference Hold function and the Up/Down and Up/Down 2 commands.

**WARNING! Crush Hazard.** In hoist applications, use the applicable safety precautions to prevent the load from falling. Failure to obey can cause death or serious injury from falling loads.

**WARNING! Sudden Movement Hazard.** When you use the Baseblock command with hoist applications, make sure that you close the holding brake when you input the Baseblock command and the drive shuts off its output. Failure to do obey can cause death or serious injury if the load moves or falls when motor suddenly coasts after you input the Baseblock command.

**WARNING! Sudden Movement Hazard.** When you use a mechanical holding brake with the drive in a lifting application, close the brake when an input terminal triggers the Baseblock command to stop drive output. Failure to obey can cause death or serious injury if a load moves because the motor suddenly coasts after you enter the Baseblock command.

- **Frequency Reference Hold Function Command:** This acceleration/deceleration ramp hold command uses an MFDI to momentarily stop the acceleration/deceleration of the motor, and continues to operate the motor at the output frequency at which the command reference was input. Turn OFF the acceleration/deceleration ramp hold command to continue acceleration/deceleration.  
With a crane for example, use the function and a 2-stage push button to stop acceleration and operate at low speed with one of the output frequencies.
- **Up/Down command:** The Up/Down command is a function to activate and deactivate an MFDI to increase and decrease the frequency reference. The Up/Down command overrides frequency references from the analog input terminal, pulse train input terminal, and keypad.
- **Up/Down 2 command:** The Up/Down 2 command is a function that adds a set bias value to the frequency reference to accelerate or decelerate. The Up/Down 2 command activates and deactivates the MFDI to add a bias value.

### ■ d4-01: Freq Reference Hold Selection

No. (Hex.)	Name	Description	Default (Range)
d4-01 (0298)	Freq Reference Hold Selection	<b>V/f</b> <b>CL-V/f</b> <b>OLV</b> <b>CLV</b> <b>AOLV</b> <b>OLV/PM</b> <b>AOLV/PM</b> <b>CLV/PM</b> <b>EZOLV</b> Sets the function that saves the frequency reference or the frequency bias (Up/Down 2) after a Stop command or when de-energizing the drive.	0 (0, 1)

Set *H1-xx [MFDI Function Select]* to one of the these values to operate this parameter:

- *A [Accel/Decel Ramp Hold]*
- *10/11 [Up/Down Command]*
- *75/76 [Up/Down 2 Command]*

#### 0 : Disabled

- **Acceleration/Deceleration Ramp Hold**  
When you enter a Stop command or de-energize the drive, the hold value is reset to 0 Hz. The drive will use the active frequency reference when it restarts.
- **Up/Down Command**  
When you enter a Stop command or de-energize the drive, the frequency reference value is reset to 0 Hz. The drive will start from 0 Hz when it restarts.
- **Combined with the Up/Down 2 Command**  
When you enter the Stop command or 5 s after you release the Up/Down 2 command, the drive does not save the frequency bias. The Up/Down 2 function will start with a bias of 0% when the drive restarts.

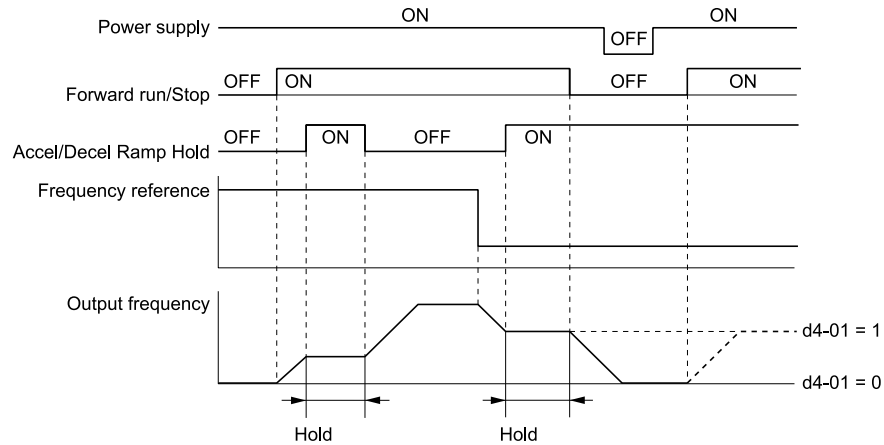
#### 1 : Enabled

- **Acceleration/Deceleration Ramp Hold**  
When you clear the Run command or de-energize the drive, it will save the last hold value. The drive will use the saved value as the frequency reference when it restarts.

#### Note:

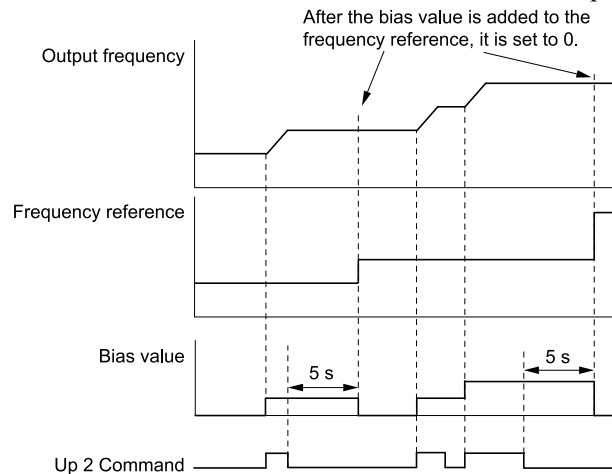
When you energize the drive, continuously enable the MFDI terminal set for *Accel/Decel Ramp Hold [H1-xx = A]* when energizing the drive. If the digital input does not activate, the drive will clear the hold value and set it to 0 Hz.





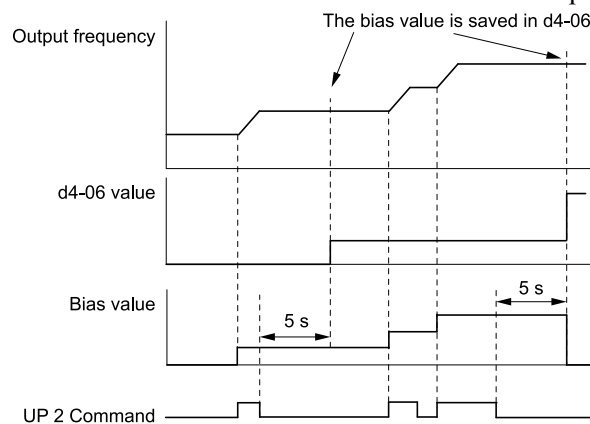
**Figure 11.64 Frequency Reference Hold with Accel/Decel Hold Function**

- **Up/Down Command**  
When you clear the Run command or de-energize the drive, it will save the frequency reference value. The drive will use the saved value as the frequency reference when it restarts.
- **Up/Down 2 Command with Frequency Reference from Keypad**  
When a Run command is active and you release the Up/Down 2 command for longer than 5 s, the drive adds the Up/Down 2 bias value to the frequency reference and sets it to 0. The drive saves the frequency reference value to which the bias value was added. The drive will use the new value as the frequency reference when it restarts.



**Figure 11.65 Up/Down 2 Example with Reference from Keypad and d4-01 = 1**

- **Up/Down 2 Command with Frequency Reference from Input Sources Other Than the Keypad**  
When a Run command is active and you release the Up/Down 2 command for longer than 5 s, the drive will save the bias value in *d4-06* [Frequency Ref Bias (Up/Down 2)]. The drive saves the frequency reference + *d4-06* as a frequency reference value. The drive will use the new value as the frequency reference when it restarts.



**Figure 11.66 Up/Down 2 Example with Other Reference than Keypad and d4-01 = 1**

**Note:**

Set the Up/Down 2 upper limit [*d4-08*] and lower limit [*d4-09*] correctly to use the frequency reference hold function and the Up/Down 2 function.

**Remove the Saved Frequency Reference Value**

The procedure to remove the saved frequency reference value is different for different functions. Use these methods to remove the value:

- Release the input programmed for *Accel/Decel Ramp Hold* [ $H1-xx = A$ ].
- Set an Up or Down command while no Run command is active.
- Use the Up/Down 2 Command to set  $d4-06 = 0.0$  or set  $d4-06 = 0.0$  during stop.

**■ d4-03: Up/Down 2 Bias Step Frequency**

No. (Hex.)	Name	Description	Default (Range)
d4-03 (02AA) RUN	Up/Down 2 Bias Step Frequency	<b>V/f</b> <b>CL-V/f</b> <b>OLV</b> <b>CLV</b> <b>AOLV</b> <b>OLV/PM</b> <b>AOLV/PM</b> <b>CLV/PM</b> <b>EZOLV</b> Sets the bias that the Up/Down 2 function adds to or subtracts from the frequency reference.	0.00 Hz (0.00 - 99.99 Hz)

The operation is different for different setting values:

**• Setting d4-03 = 0.00 Hz**

When the *Up/Down 2 Command* [ $H1-xx = 75, 76$ ] is active, the drive uses the accel/decel times set in  $d4-04$  [*Up/Down 2 Ramp Selection*] to increase or decrease the bias value.

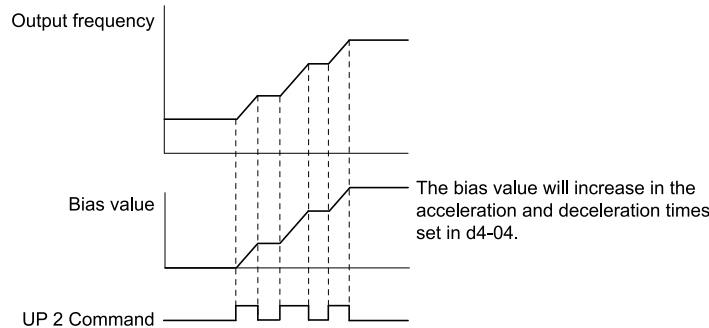


Figure 11.67 Up/Down 2 Bias when d4-03 = 0.00 Hz

**• Setting d4-03 ≠ 0.00 Hz**

When the *Up/Down 2 Command* [ $H1-xx = 75, 76$ ] is active, the drive increases or decreases the bias in steps for the value set in  $d4-03$ . The drive uses the acceleration and deceleration times set in  $d4-04$ .

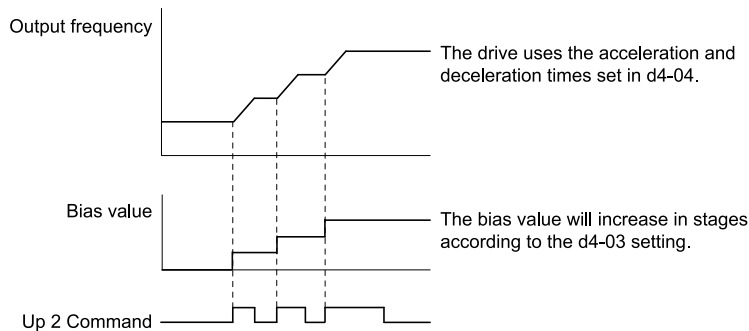


Figure 11.68 Up/Down 2 Bias when d4-03 ≠ 0.00 Hz

**■ d4-04: Up/Down 2 Ramp Selection**

No. (Hex.)	Name	Description	Default (Range)
d4-04 (02AB) RUN	Up/Down 2 Ramp Selection	<b>V/f</b> <b>CL-V/f</b> <b>OLV</b> <b>CLV</b> <b>AOLV</b> <b>OLV/PM</b> <b>AOLV/PM</b> <b>CLV/PM</b> <b>EZOLV</b> Sets the acceleration and deceleration times for the Up/Down 2 function to apply the bias to the frequency reference.	0 (0, 1)

**0 : Use Selected Accel/Decel Time**

Use the active acceleration and deceleration times to increase or decrease the bias.

**1 : Use Accel/Decel Time 4**

Use  $C1-07$  [*Acceleration Time 4*] and  $C1-08$  [*Deceleration Time 4*] to increase or decrease the bias.

### ■ d4-05: Up/Down 2 Bias Mode Selection

No. (Hex.)	Name	Description	Default (Range)
d4-05 (02AC) RUN	Up/Down 2 Bias Mode Selection	<div style="display: flex; justify-content: space-between; font-size: 0.8em; font-weight: bold; margin-bottom: 5px;"> <span>V/f</span> <span>CL-V/f</span> <span>OLV</span> <span>CLV</span> <span>AOLV</span> <span>OLV/PM</span> <span>AOLV/PM</span> <span>CLV/PM</span> <span>EZOLV</span> </div> Sets the function that saves the bias value to the drive when you open or close the two <i>Up/Down 2 Commands</i> [ <i>H1-xx = 75, 76</i> ]. Set <i>d4-03 [Up/Down 2 Bias Step Frequency] = 0.00</i> before you set this parameter.	0 (0, 1)

#### 0 : Hold when Neither Up/Down Closed

When the two MFDI terminals set for *Up/Down 2 Command* [*H1-xx = 75, 76*] activate or deactivate, the drive will hold the bias value.

#### 1 : Reset when Neither / Both Closed

When the two MFDI terminals set for *Up/Down 2 Command* [*H1-xx = 75, 76*] activate or deactivate, the drive will reset the bias value to 0. The drive will use the acceleration and deceleration times set in *d4-04 [Up/Down 2 Ramp Selection]* to accelerate and decelerate the motor to the selected output frequency.

### ■ d4-06: Frequency Ref Bias (Up/Down 2)

No. (Hex.)	Name	Description	Default (Range)
d4-06 (02AD)	Frequency Ref Bias (Up/Down 2)	<div style="display: flex; justify-content: space-between; font-size: 0.8em; font-weight: bold; margin-bottom: 5px;"> <span>V/f</span> <span>CL-V/f</span> <span>OLV</span> <span>CLV</span> <span>AOLV</span> <span>OLV/PM</span> <span>AOLV/PM</span> <span>CLV/PM</span> <span>EZOLV</span> </div> Saves the bias value from the <i>Up/Down 2 Command</i> when the value set in <i>E1-04</i> is 100%.	0.0% (-99.9 - +100.0%)

The *Up/Down 2* function setting changes the function of *d4-06*:

#### Note:

When the keypad sets the frequency reference, you do not usually use parameter *d4-06*.

- When *d4-01 = 0 [Freq Reference Hold Selection = Disabled]* and a source other than the keypad sets the frequency reference, the drive adds the value set in *d4-06* to the frequency reference. If the value set in *d4-06* is a negative number, the drive will subtract it from frequency reference.
- When *d4-01 = 1 [Enabled]* and a source other than the keypad sets the frequency reference, the drive will store the bias value adjusted with the *Up/Down 2* command in *d4-06* 5 seconds after you release the *Up/Down 2* command. The drive adds or subtracts the value set in *d4-06* to the frequency reference.

#### Conditions that Reset or Disable d4-06

The drive resets and disables the bias value in these conditions:

- *d4-01 = 0* and the Run command was cleared.
- *H1-xx = 75, 76 [MFDI Function Select = Up/Down 2 Command]* is not set.
- The frequency reference source was changed.  
This includes switching LOCAL/REMOTE and multi-step speed reference.
- A digital input changed the frequency reference value.
- *d4-03 [Up/Down 2 Bias Step Frequency] = 0* and *d4-05 = 1 [Up/Down 2 Bias Mode Selection = Reset when Neither / Both Closed]*, and the two MFDI terminals set for *Up/Down 2 Command* [*H1-xx = 75/76*] are activated or deactivated.
- The value of *E1-04 [Maximum Output Frequency]* was changed.

### ■ d4-07: Analog Freq Ref Fluctuate Limit

No. (Hex.)	Name	Description	Default (Range)
d4-07 (02AE) RUN	Analog Freq Ref Fluctuate Limit	<div style="display: flex; justify-content: space-between; font-size: 0.8em; font-weight: bold; margin-bottom: 5px;"> <span>V/f</span> <span>CL-V/f</span> <span>OLV</span> <span>CLV</span> <span>AOLV</span> <span>OLV/PM</span> <span>AOLV/PM</span> <span>CLV/PM</span> <span>EZOLV</span> </div> If the frequency reference changes for more than the level set to this parameter, then the bias value will be held. Parameter <i>E1-04 [Maximum Output Frequency]</i> is 100%.	1.0% (0.1 - 100.0%)

Handles frequency reference changes while *Up/Down 2 Command* [*H1-xx = 75, 76*] is activated. When the frequency reference changes for more than the level set in *d4-07*, the drive will hold the bias value, and the drive will accelerate or decelerate to the frequency reference. When the drive is at the frequency reference, it releases the bias hold and the bias follows the *Up/Down 2* input commands.

This parameter is applicable only when an analog or pulse input sets the frequency reference.

### ■ d4-08: Up/Down 2 Bias Upper Limit

No. (Hex.)	Name	Description	Default (Range)
d4-08 (02AF) RUN	Up/Down 2 Bias Upper Limit	<b>V/f</b> <b>CL-V/f</b> <b>OLV</b> <b>CLV</b> <b>AOLV</b> <b>OLV/PM</b> <b>AOLV/PM</b> <b>CLV/PM</b> <b>EZOLV</b> Sets the upper limit of the Up/Down 2 bias as a percentage of <i>E1-04</i> [Maximum Output Frequency].	100.0% (0.0 - 100.0%)

The drive saves the set bias upper limit in *d4-06* [Frequency Ref Bias (Up/Down 2)]. Set *d4-08* an applicable value before you use the Up/Down 2 function.

**Note:**

When *d4-01* = 1 [Freq Reference Hold Selection = Enabled] and *b1-01* = 0 [Frequency Reference Selection 1 = Keypad], the drive will add the bias value to the frequency reference when it does not receive an Up/Down 2 command for 5 s. Then the drive will reset the value to 0 at which time you can increase the bias to the limit set in *d4-08* again.

### ■ d4-09: Up/Down 2 Bias Lower Limit

No. (Hex.)	Name	Description	Default (Range)
d4-09 (02B0) RUN	Up/Down 2 Bias Lower Limit	<b>V/f</b> <b>CL-V/f</b> <b>OLV</b> <b>CLV</b> <b>AOLV</b> <b>OLV/PM</b> <b>AOLV/PM</b> <b>CLV/PM</b> <b>EZOLV</b> Sets the lower limit of the Up/Down 2 bias as a percentage of <i>E1-04</i> [Maximum Output Frequency].	0.0% (-99.9 - 0.0%)

The drive saves the set bias lower limit in *d4-06* [Frequency Ref Bias (Up/Down 2)]. Set *d4-09* to an applicable value before you use the Up/Down 2 function.

**Note:**

When *d4-01* = 1 [Freq Reference Hold Selection = Enabled] and *b1-01* = 0 [Frequency Reference Selection 1 = Keypad], the drive will add the bias value to the frequency reference when it does not receive an Up/Down 2 command for 5 s. Then the drive will reset the value to 0.

If you increase the bias with the Up 2 command and *d4-09* = 0, you cannot use a Down 2 command to decrease the frequency reference. To decrease speed in this condition, set a negative lower limit in *d4-09*.

### ■ d4-10: Up/Down Freq Lower Limit Select

No. (Hex.)	Name	Description	Default (Range)
d4-10 (02B6)	Up/Down Freq Lower Limit Select	<b>V/f</b> <b>CL-V/f</b> <b>OLV</b> <b>CLV</b> <b>AOLV</b> <b>OLV/PM</b> <b>AOLV/PM</b> <b>CLV/PM</b> <b>EZOLV</b> Sets the lower frequency limit for the Up/Down function.	0 (0, 1)

### 0 : Greater of d2-02 or Analog

The higher value between *d2-02* [Frequency Reference Lower Limit] and an analog input programmed for Frequency Reference [*H3-02*, *H3-06*, *H3-10* = 0] sets the lower frequency reference limit.

**Note:**

When you use External Reference 1/2 Selection [*H1-xx* = 2] to switch between the Up/Down function and an analog input as the reference source, the analog value becomes the lower reference limit when the Up/Down command is active. Set *d4-10* = 1 to isolate the Up/Down function and the analog input value.

### 1 : d2-02

You can only use *d2-02* to set the lower limit of the frequency reference.

### ■ d4-11: Bi-directional Output Selection

No. (Hex.)	Name	Description	Default (Range)
d4-11 (02B7)	Bi-directional Output Selection	<b>V/f</b> <b>CL-V/f</b> <b>OLV</b> <b>CLV</b> <b>AOLV</b> <b>OLV/PM</b> <b>AOLV/PM</b> <b>CLV/PM</b> <b>EZOLV</b> Sets the function that changes the frequency reference to a Bi-Directional internal frequency reference.	0 (0, 1)

### 0 : Disabled

The drive will not change the frequency reference or PID output value to Bi-Directional internal frequency reference.

When the frequency reference or PID output value is 0% to 100% of the maximum output frequency, the drive runs the motor in the set direction.

### 1 : Enabled

Changes the frequency reference or PID output value to Bi-Directional output.

When the frequency reference or PID output value is 0% to 50%, the drive reverses the motor in the set direction. When the frequency reference or PID output value is 50% to 100%, the drive operates the motor in the set direction.

#### Note:

When you use the Bi-Directional function with PID control, you can use an MFDI terminal set for *PID Bi-Directional Enable [H1-xx = 7F]* to enable/disable the Bi-Directional function.

Table 11.43 shows how the drive operates when you use the PID control function with the Bi-Directional function and  $d4-11 = 1$ :

Table 11.43 Bi-Directional Function Operation Conditions

b5-01 [PID Mode Setting] Setting	Status of MFDI Terminal Set for 7F [PID Bi-Directional Enable]	
	ON	OFF
b5-01 = 0 [Disabled]	Bi-Directional function enabled	Bi-Directional function enabled
b5-01 ≠ 0 [Enabled]	Bi-Directional function enabled	Normal operation (Bi-Directional function disables)

- **When PID Control is Disabled or  $H1-xx = 19$  [MFDI Function Select = PID Disable] is Activated**

When the frequency reference is 0% to 50%, the drive reverses the motor in the set direction. When the frequency reference is 50% to 100%, the drive operates the motor in the set direction. Figure 11.69 shows the frequency reference change at this time. This is an example of operation when the Forward Run command is input.

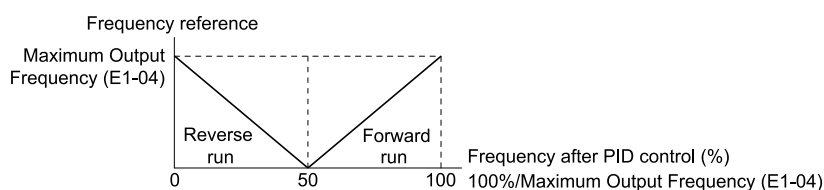


Figure 11.69 Frequency Reference Transition when PID Control is Disabled or PID Disable is ON

#### Note:

When  $b1-04 = 1$  [Reverse Operation Selection = Reverse Disabled], the drive will not run in Reverse. The frequency reference limit is 0 Hz.

- **When PID Control is Enabled and  $H1-xx = 7F$  [PID Bi-Directional Enable] is Activated**

The Bi-Directional function is enabled. When the frequency reference is 0% to 50% after PID control execution, the drive runs the motor opposite of the set direction. When the frequency reference is 50% to 100%, the drive runs the motor in the set direction. Figure 11.70 shows the frequency reference change at this time. This is an example of the operation when the Forward Run command is input.

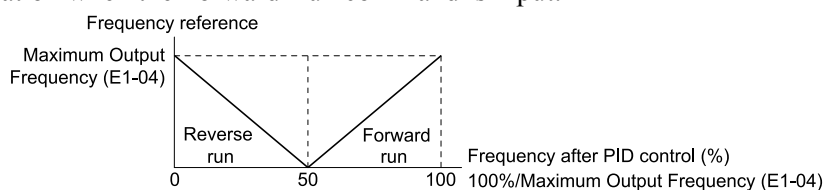


Figure 11.70 Frequency Reference Transition when PID Control and PID Bi-Directional are Enabled

#### Note:

When  $b1-04 = 1$ , the drive will not run the motor in Reverse. The frequency reference limit is 0 Hz.

- **When PID Control is Enabled and  $H1-xx = 7F$  is Deactivated**

The Bi-Directional function is disabled. When the frequency reference is a negative value after PID control execution, the drive runs the motor opposite of the set direction. The frequency reference value is an absolute value.

## ■ d4-12: Stop Position Gain

No. (Hex.)	Name	Description	Default (Range)
d4-12 (02B8)	Stop Position Gain	<div style="display: flex; justify-content: space-between; font-size: small; font-weight: bold;"> <span>V/f</span> <span>CL-V/f</span> <span>OLV</span> <span>CLV</span> <span>AOLV</span> <span>OLV/PM</span> <span>AOLV/PM</span> <span>CLV/PM</span> <span>EZOLV</span> </div> Sets the gain to adjust the stopping accuracy. Set this parameter when $b1-03 = 9$ [Stopping Method Selection = Stop with Constant Distance].	1.00 (0.50 - 2.55)

If the motor stops before the necessary stop position, increase the setting value. If the length of time for the motor to stop is too long, decrease the setting value.

## ◆ d5: Torque Control

*d5 parameters* set the Torque Control function.

The Torque Control function controls the output torque of the motor. You can use Torque Control for roller drives, winders, unwinders, conveyors and other machines that use tension control and push/pull applications. When there is no more material and the machine suddenly has no load, the drive uses Torque Control and the speed limit function to keep the rotation speed of the motor from increasing.

Set  $A1-02$  [Control Method Selection] to one of these values to use Torque Control:

- 3 [Closed Loop Vector]
- 4 [Advanced Open Loop Vector]
- 6 [PM Advanced Open Loop Vector]
- 7 [PM Closed Loop Vector]

### Note:

When you use Torque Control and  $A1-02 = 4$ , use a motor designed for winding applications.

Use one of these methods to enable Torque Control:

- Set  $d5-01 = 1$  [Torque Control Selection = Torque Control].
- Set  $H1-xx = 71$  [Torque Control] ON.

## ■ Torque Control Operation

Figure 11.71 shows the operation principle of Torque Control:

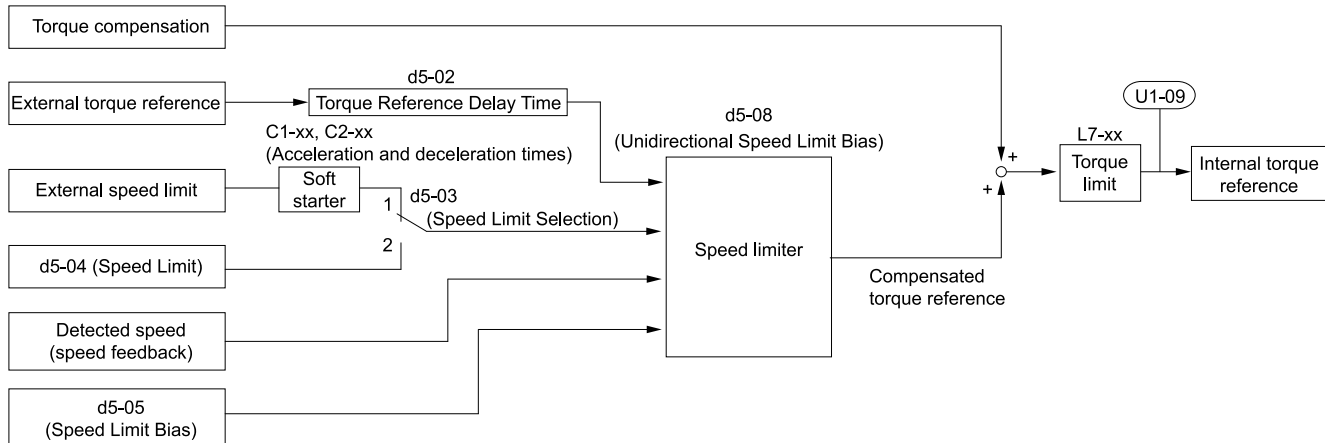


Figure 11.71 Torque Control Block Diagram

The externally input torque reference is the target value for the motor output torque. If the motor output torque and load torque are not balanced during Torque Control, the motor accelerates or decelerates. To prevent operation at more than the speed limit, compensate the external torque reference value if the motor speed is at the limit. The speed limit, speed feedback, and the speed limit bias are the values that calculate the compensation value.

When an external torque compensation value is input, the drive adds that value to the speed limit compensated torque reference value. The values  $L7-01$  to  $L7-04$  [Torque Limit] limit the value. The drive uses the value as the internal torque reference. You can use  $U1-09$  [Torque Reference] to monitor the calculated torque reference. The torque limit values set in  $L7-01$  to  $L7-04$  are most important. Although you can set a higher external torque reference from an external source, the motor will not operate a torque output higher than values set in  $L7-01$  to  $L7-04$ .

## ■ Setting the Torque Reference, Speed Limit, and Torque Compensation Values

### Torque Control Input Value Selection

Table 11.44 lists the method for torque control input signals.

**Table 11.44 The Method for Torque Control Input Signals**

Configuration Parameter	Signal Input Method	Parameter Settings	Notes
Torque Reference	Drive analog input terminals A1, A2, A3	$H3-02, H3-10, H3-06 = 13$ [MFAI Function Select= Torque Reference / Torque Limit] *1	The level of the set input signal must align with the polarity of the external signals.
	Analog reference option cards AI-A3	<ul style="list-style-type: none"> <li><math>F2-01 = 0</math> [Analog Input Function Selection = 3 Independent Channels]</li> <li><math>H3-02, H3-10, \text{ and } H3-06 = 13</math> *1</li> </ul>	$H3-02, H3-10, \text{ or } H3-06$ settings are enabled for the option card input terminal. The level of the set input signal must align with the polarity of the external signals.
	MEMOBUS register 0004H	<ul style="list-style-type: none"> <li><math>b1-01 = 2</math> [Frequency Reference Selection 1 = Memobus/Modbus Communications]</li> <li>When register bit 2 of 000FH = 1, the torque reference and torque limit from register 0004H is enabled.</li> </ul>	-
	Communication option card	<ul style="list-style-type: none"> <li><math>b1-01 = 3</math> [Option PCB]</li> <li><math>F6-06 = 1</math> [Torque Reference/Limit by Comm = Enabled]</li> </ul> Refer to the communication option card manual for more information about the torque reference setting.	-
Speed Limit	Frequency Reference Selection (Reference source selected with b1-01)	$d5-03 = 1$ [Speed Limit Selection = Active Frequency Reference] The drive gets the speed limit from the frequency reference source input in $b1-01$ or $b1-15$ [Frequency Reference Selection 2]. *1	The drive applies the settings in $C1-01$ to $C1-08$ [Acceleration/Deceleration Times] and $C2-01$ to $C2-04$ [S-Curve Time @ Start/End of Accel/Decel] to the speed limit.
	$d5-04$ [Speed Limit]	$d5-03 = 2$ [ $d5-04$ Setting]	-
Torque Compensation	Drive analog input terminals A1, A2, A3	$H3-02, H3-10, \text{ or } H3-06 = 14$ [Torque Compensation] *1	The level of the set input signal must align with the polarity of the external signals.
	Analog reference option cards AI-A3	<ul style="list-style-type: none"> <li><math>F2-01 = 0</math></li> <li><math>H3-02, H3-10, \text{ or } H3-06 = 14</math> *1</li> </ul>	$H3-02, H3-10, \text{ or } H3-06$ settings are enabled for the option card input terminal. The level of the set input signal must align with the polarity of the external signals.
	MEMOBUS register 0005H	<ul style="list-style-type: none"> <li><math>b1-01 = 2</math></li> <li>When register bit 3 of 000FH = 1, the torque reference and torque limit from register 0005H is enabled.</li> </ul>	-
	Communication option card	$b1-01 = 3$ Refer to the communication option card manual for more information about the torque reference setting.	-

\*1 Sets analog input terminals A1, A2, and A3 to supply the speed limit, torque reference, or torque compensation. If you set the same function to A1 to A3 terminals with  $H3-02, H3-10, \text{ or } H3-06$ , the drive will detect  $oPE07$  [Analog Input Selection Error].

### Input Signal Polarity

The positive and negative torque references set the motor rotation direction. The direction of the Run command does not set it. The positive and negative torque reference signals and the direction of the Run command have an effect on the internal torque reference.

**Table 11.45 Torque Control Signal Polarity**

Run Command Direction	Torque Reference Signal Polarity	Direction of Motor Rotation	Polarity of the Internal Torque Reference [U1-09]
Forward run	+ (Positive)	Forward direction	+ (Positive)
	- (Negative)	Reverse direction	- (Negative)
Reverse run	+ (Positive)	Reverse direction	- (Negative)
	- (Negative)	Forward direction	+ (Positive)

**Note:**

For Yaskawa motors, the forward run direction is counterclockwise direction when seen from the load shaft.

When you use analog inputs, you can get negative input values with these methods:

- Apply negative voltage input signals.
- Use positive voltage input signals and set the analog input bias to negative values.
- Apply positive voltage input signals and use a digital input programmed for *Analog TorqueRef Polarity Invert* [H1-xx = 78].

When you use MEMOBUS/Modbus communication or a communication option card, set the positive or negative signed torque reference.

When the level of the analog signal input is 0 V to 10 V or 4 mA to 20 mA, the torque reference is the forward direction. To reverse the polarity of the torque reference, use one of these two methods:

- Use a -10 V to +10 V voltage input
- Set H1-xx = 78 [MFDI Function Select = Analog TorqueRef Polarity Invert].

**■ Speed Limit and Speed Limit Bias**

The drive reads the speed limit setting from the input selected in d5-03 [Speed Limit Selection]. You can use d5-05 [Speed Limit Bias] to add a bias to this speed. Parameter d5-08 [Uni-directional Speed Limit Bias] sets how the drive applies bias to the speed limit.

Table 11.46 shows the relation between these settings:

**Table 11.46 Speed Limit, Speed Bias and Speed Limit Priority Selection**

Run command	Operating Conditions							
	Forward	Reverse	Forward	Reverse	Forward	Reverse	Forward	Reverse
Torque reference direction	+ (Positive)	+ (Positive)	- (Negative)	- (Negative)	- (Negative)	- (Negative)	+ (Positive)	+ (Positive)
Speed limit direction	+ (Positive)	- (Negative)	- (Negative)	+ (Positive)	+ (Positive)	- (Negative)	- (Negative)	+ (Positive)
Direction of motor rotation	Forward		Reverse		Forward		Reverse	
Generated torque (d5-08 = 0 [Disabled]) */								





### ■ d5-01: Torque Control Selection

No. (Hex.)	Name	Description	Default (Range)
d5-01 (029A)	Torque Control Selection	<input type="checkbox"/> V/f <input type="checkbox"/> CL-V/f <input type="checkbox"/> OLV <input checked="" type="checkbox"/> CLV <input type="checkbox"/> AOLV <input type="checkbox"/> OLV/PM <input type="checkbox"/> AOLV/PM <input type="checkbox"/> CLV/PM <input type="checkbox"/> EZOLV Sets the drive for torque control or speed control.	0 (0, 1)

#### 0 : Speed Control

Enables Speed Control. The drive controls the speed as specified by *C5-01 to C5-07 [Speed Control (ASR) Setting Parameters]*.

Also use this setting when you use *H1-xx = 71 [MFDI Function Select = Torque Control]* to change between Speed Control and Torque Control.

#### 1 : Torque Control

Always enables Torque Control.

### ■ d5-02: Torque Reference Delay Time

No. (Hex.)	Name	Description	Default (Range)
d5-02 (029B)	Torque Reference Delay Time	<input type="checkbox"/> V/f <input type="checkbox"/> CL-V/f <input type="checkbox"/> OLV <input checked="" type="checkbox"/> CLV <input type="checkbox"/> AOLV <input type="checkbox"/> OLV/PM <input type="checkbox"/> AOLV/PM <input type="checkbox"/> CLV/PM <input type="checkbox"/> EZOLV Sets the primary delay time constant for the torque reference filter.	Determined by A1-02 (0 - 1000 ms)

This parameter applies a primary delay filter to the torque reference signal to stop oscillation caused by a torque reference signal that is not stable. This also helps remove electrical interference from the torque reference signal and helps adjust the responsiveness between host controllers.

If oscillation occurs during Torque Control, increase the setting value. If the setting value is too high, responsiveness becomes unsatisfactory.

### ■ d5-03: Speed Limit Selection

No. (Hex.)	Name	Description	Default (Range)
d5-03 (029C)	Speed Limit Selection	<input type="checkbox"/> V/f <input type="checkbox"/> CL-V/f <input type="checkbox"/> OLV <input checked="" type="checkbox"/> CLV <input type="checkbox"/> AOLV <input type="checkbox"/> OLV/PM <input type="checkbox"/> AOLV/PM <input type="checkbox"/> CLV/PM <input type="checkbox"/> EZOLV Sets the torque control speed limit method.	1 (1, 2)

#### 1 : Active Frequency Reference

The enabled frequency reference set in *b1-01 [Frequency Reference Selection 1]* or *b1-15 [Frequency Reference Selection 2]* will be the speed limit. The drive applies the values set in *C1-01 to C1-08 [Acceleration/Deceleration Times 1 to 4]* and *C2-01 to C2-04 [S-Curve Time @ Start/End of Accel]* as speed limits.

#### 2 : d5-04 Setting

The speed limit is the value set in *d5-04*.

### ■ d5-04: Speed Limit

No. (Hex.)	Name	Description	Default (Range)
d5-04 (029D)	Speed Limit	<input type="checkbox"/> V/f <input type="checkbox"/> CL-V/f <input type="checkbox"/> OLV <input checked="" type="checkbox"/> CLV <input type="checkbox"/> AOLV <input type="checkbox"/> OLV/PM <input type="checkbox"/> AOLV/PM <input type="checkbox"/> CLV/PM <input type="checkbox"/> EZOLV Sets the speed limit during Torque Control as a percentage of <i>E1-04 [Maximum Output Frequency]</i> . Set <i>d5-03 = 2 [Speed Limit Selection = d5-04 Setting]</i> before you set this parameter.	0% (-120 - +120%)

The speed limit is a positive value when it is in the same direction as the Run command. The speed limit is a negative value when it is in the opposite direction of the Run command.

### ■ d5-05: Speed Limit Bias

No. (Hex.)	Name	Description	Default (Range)
d5-05 (029E)	Speed Limit Bias	<input type="checkbox"/> V/f <input type="checkbox"/> CL-V/f <input type="checkbox"/> OLV <input checked="" type="checkbox"/> CLV <input type="checkbox"/> AOLV <input type="checkbox"/> OLV/PM <input type="checkbox"/> AOLV/PM <input type="checkbox"/> CLV/PM <input type="checkbox"/> EZOLV Sets a bias to the speed limit as a percentage of <i>E1-04 [Maximum Output Frequency]</i> .	10% (0 - 120%)

Adjusts the margin for the speed limit.

### ■ d5-06: Speed/Torque Changeover Time

No. (Hex.)	Name	Description	Default (Range)
d5-06 (029F)	Speed/Torque Changeover Time	<div style="display: flex; justify-content: space-between; font-size: 0.8em; font-weight: normal;"> <span>V/f</span> <span>CL-V/f</span> <span>OLV</span> <span>CLV</span> <span>AOLV</span> <span>OLV/PM</span> <span>AOLV/PM</span> <span>CLV/PM</span> <span>EZOLV</span> </div> <p>Sets the delay time to switch between Speed Control and Torque Control. Set <math>H1-xx = 71</math> [<i>MFDI Function Select = Torque Control</i>] before you set this parameter.</p>	0 ms (0 - 1000 ms)

The analog input (torque reference, speed limit value) holds at the value when the drive switched between Speed and Torque Control in the time of the Speed/Torque Changeover Timer. During this time, prepare to switch to an external source.

### ■ d5-08: Uni-directional Speed Limit Bias

No. (Hex.)	Name	Description	Default (Range)
d5-08 (02B5)	Uni-directional Speed Limit Bias	<div style="display: flex; justify-content: space-between; font-size: 0.8em; font-weight: normal;"> <span>V/f</span> <span>CL-V/f</span> <span>OLV</span> <span>CLV</span> <span>AOLV</span> <span>OLV/PM</span> <span>AOLV/PM</span> <span>CLV/PM</span> <span>EZOLV</span> </div> <p>Sets the direction of the speed limit reference to which Speed Limit Bias [<i>d5-05</i>] applies.</p>	1 (0, 1)

#### 0 : Disabled

The drive applies the speed limit bias in the speed limit direction and the opposite direction.

#### 1 : Enabled

The drive applies the speed limit bias in the opposite direction of the speed limit only.

## ◆ d6: Field Weakening /Forcing

*d6 parameters* set the field weakening and field forcing functions.

The field weakening function decreases the energy consumption of the motor. It decreases the output voltage of the drive to a set level. The function decreases the motor excitation current inversely proportional to speed in a constant output range, and does not let the induced voltage of the motor become more than the power supply voltage. To enable this function, set *Field Weakening* [ $H1-xx = 63$ ] ON.

#### Note:

Use the Field Weakening function in constant light-load applications. To control the energy consumption of the motor for other load conditions, use the *b8 parameters* [*Energy Saving*].

The Field Forcing function adjusts the delaying influence of the motor time constant when the drive changes the excitation current reference and it also increases motor responsiveness. This function uses a high motor excitation current reference for drive start-up only to help develop actual motor excitation current. Enable the Field Forcing function to increase motor responsiveness.

#### Note:

You cannot use Field Forcing during DC Injection Braking.

### ■ d6-01: Field Weakening Level

No. (Hex.)	Name	Description	Default (Range)
d6-01 (02A0)	Field Weakening Level	<div style="display: flex; justify-content: space-between; font-size: 0.8em; font-weight: normal;"> <span>V/f</span> <span>CL-V/f</span> <span>OLV</span> <span>CLV</span> <span>AOLV</span> <span>OLV/PM</span> <span>AOLV/PM</span> <span>CLV/PM</span> <span>EZOLV</span> </div> <p>Sets the drive output voltage as a percentage of <math>E1-05</math> [<i>Maximum Output Voltage</i>] when <math>H1-xx = 63</math> [<i>Field Weakening</i>] is activated.</p>	80% (0 - 100%)

### ■ d6-02: Field Weakening Frequency Limit

No. (Hex.)	Name	Description	Default (Range)
d6-02 (02A1)	Field Weakening Frequency Limit	<div style="display: flex; justify-content: space-between; font-size: 0.8em; font-weight: normal;"> <span>V/f</span> <span>CL-V/f</span> <span>OLV</span> <span>CLV</span> <span>AOLV</span> <span>OLV/PM</span> <span>AOLV/PM</span> <span>CLV/PM</span> <span>EZOLV</span> </div> <p>Sets the minimum output frequency to start field weakening.</p>	0.0 Hz (0.0 - 590.0 Hz)

Make sure that these two conditions are correct to enable the Field Weakening command:

- The output frequency  $\geq d6-02$ .
- There is a speed agreement status.

■ **d6-03: Field Forcing Selection**

No. (Hex.)	Name	Description	Default (Range)
d6-03 (02A2)	Field Forcing Selection	<div style="display: flex; justify-content: space-between; font-size: small;"> <span>V/f</span> <span>CL-V/f</span> <span>OLV</span> <span>CLV</span> <span>AOLV</span> <span>OLV/PM</span> <span>AOLV/PM</span> <span>CLV/PM</span> <span>EZOLV</span> </div> Sets the field forcing function.	0 (0, 1)

0 : Disabled

1 : Enabled

■ **d6-06: Field Forcing Limit**

No. (Hex.)	Name	Description	Default (Range)
d6-06 (02A5)	Field Forcing Limit	<div style="display: flex; justify-content: space-between; font-size: small;"> <span>V/f</span> <span>CL-V/f</span> <span>OLV</span> <span>CLV</span> <span>AOLV</span> <span>OLV/PM</span> <span>AOLV/PM</span> <span>CLV/PM</span> <span>EZOLV</span> </div> Sets the maximum level that Field Forcing can increase the excitation current reference as a percentage of E2-03 [Motor No-Load Current]. Usually it is not necessary to change this setting.	400% (100 - 400%)

**Note:**

You cannot use Field Forcing during DC Injection Braking.

◆ **d7: Offset Frequency**

The drive will use 3 digital signal inputs, to add or subtract the set frequency (Offset frequency) to/from the frequency reference and correct the speed. The drive uses the terminal set in H1-xx = 44 to 46 [MFDI Function Select = Add Offset Frequency 1 to 3] to set the Offset frequency. When you close more than one input at the same time, the drive adds the selected offset values together.

Figure 11.73 shows the Offset frequency function:

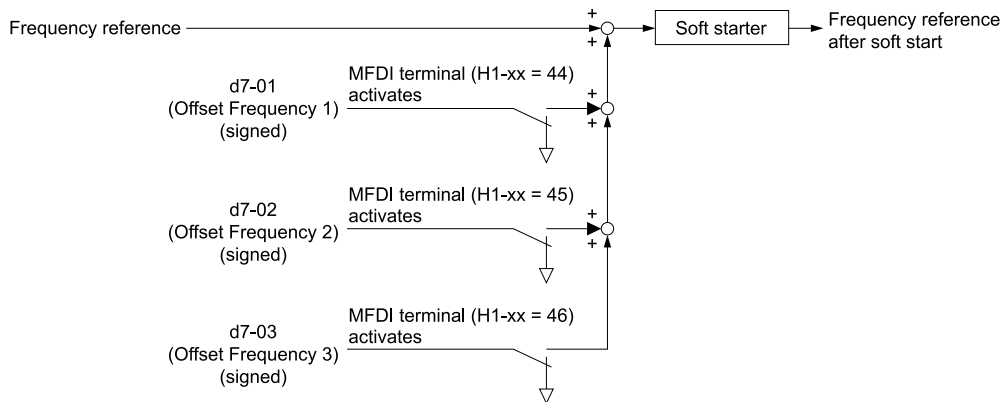


Figure 11.73 Offset Frequency Operation

■ **d7-01: Offset Frequency 1**

No. (Hex.)	Name	Description	Default (Range)
d7-01 (02B2) RUN	Offset Frequency 1	<div style="display: flex; justify-content: space-between; font-size: small;"> <span>V/f</span> <span>CL-V/f</span> <span>OLV</span> <span>CLV</span> <span>AOLV</span> <span>OLV/PM</span> <span>AOLV/PM</span> <span>CLV/PM</span> <span>EZOLV</span> </div> Sets the value to add to or subtract from the frequency reference when H1-xx = 44 [MFDI Function Select = Add Offset Frequency 1 (d7-01)] as a percentage of E1-04 [Maximum Output Frequency].	0.0% (-100.0 - +100.0%)

### ■ d7-02: Offset Frequency 2

No. (Hex.)	Name	Description	Default (Range)
d7-02 (02B3) RUN	Offset Frequency 2	<div style="display: flex; justify-content: space-between; font-size: 0.8em; font-weight: bold; margin-bottom: 5px;"> <span>V/f</span> <span>CL-V/f</span> <span>OLV</span> <span>CLV</span> <span>AOLV</span> <span>OLV/PM</span> <span>AOLV/PM</span> <span>CLV/PM</span> <span>EZOLV</span> </div> Sets the value to add to or subtract from the frequency reference when $H1-xx = 45$ [MFDI Function Select = Add Offset Frequency 2 (d7-02)] as a percentage of $E1-04$ [Maximum Output Frequency].	0.0% (-100.0 - +100.0%)

### ■ d7-03: Offset Frequency 3

No. (Hex.)	Name	Description	Default (Range)
d7-03 (02B4) RUN	Offset Frequency 3	<div style="display: flex; justify-content: space-between; font-size: 0.8em; font-weight: bold; margin-bottom: 5px;"> <span>V/f</span> <span>CL-V/f</span> <span>OLV</span> <span>CLV</span> <span>AOLV</span> <span>OLV/PM</span> <span>AOLV/PM</span> <span>CLV/PM</span> <span>EZOLV</span> </div> Sets the value to add to or subtract from the frequency reference when $H1-xx = 46$ [MFDI Function Select = Add Offset Frequency 3 (d7-03)] as a percentage of $E1-04$ [Maximum Output Frequency].	0.0% (-100.0 - +100.0%)

## 11.6 E: Motor Parameters

*E* parameters cover drive input voltage, V/f pattern, and motor parameters.

### ◆ E1: V/f Pattern for Motor 1

*E1* parameters are used to set the drive input voltage and motor V/f characteristics. To switch drive operation from one motor to another motor, set the V/f characteristics for motor 1.

#### ■ V/f Pattern Settings

The drive uses a V/f pattern to adjust the output voltage relative to the frequency reference.

This product has been preconfigured with 15 voltage/frequency (V/f) patterns. Use *E1-03* [*V/f Pattern Selection*] to select the V/f pattern that is appropriate for the application.

Additionally, one custom V/f pattern is available. Set *E1-03* = *F* [*Custom*] and then manually set parameters *E1-04* to *E1-10*.

**Table 11.47 Predefined V/f Patterns**

Setting	Specification	Characteristic	Application
0	Const Trq, 50Hz base, 50Hz max	Constant torque	For general purpose applications. This pattern is used when the load torque is constant without any rotation speed such as that used for linear conveyor systems.
1	Const Trq, 60Hz base, 60Hz max		
2	Const Trq, 50Hz base, 60Hz max		
3	Const Trq, 60Hz base, 72Hz max		
4	VT, 50Hz, 65% Vmid reduction	Variable torque	This pattern is used for torque loads proportional to 2 or 3 times the rotation speed, such as is the case with fans and pumps.
5	VT, 50Hz, 50% Vmid reduction		
6	VT, 60Hz, 65% Vmid reduction		
7	VT, 60Hz, 50% Vmid reduction		
8	High Trq, 50Hz, 25% Vmin boost	High starting torque	This pattern is used when strong torque is required during startup.
9	High Trq, 50Hz, 65% Vmin boost		
A	High Trq, 60Hz, 25% Vmin boost		
B	High Trq, 60Hz, 65% Vmin boost		
C	High Freq, 60Hz base, 90Hz max	Constant output	This pattern is used to rotate motors at greater than 60 Hz. Output voltage is constant when operating at greater than 60 Hz.
D	High Freq, 60Hz base, 120Hz max		
E	High Freq, 60Hz base, 180Hz max		
F	Custom	Constant torque	Enables a custom V/f pattern by changing <i>E1-04</i> to <i>E1-13</i> [ <i>V/f Pattern for Motor 1</i> ]. The default settings for <i>E1-04</i> to <i>E1-13</i> are equivalent to <i>Setting Value 1</i> [ <i>Const Trq, 60Hz base, 60Hz max</i> ].

**Note:**

Be aware of the following points when manually setting V/f patterns.

- To set linear V/f characteristics at frequencies lower than that of E1-06, set E-07 = E1-09. In this case, the setting for E1-08 will be disregarded.
- Ensure that the five frequencies are set according to the following rules to prevent triggering oPE10 [V/f Data Setting Error];  
 $E1-09 \leq E1-07 < E1-06 \leq E1-11 \leq E1-04$
- Setting E1-11 = 0 [Mid Point B Frequency = 0 Hz] disables E1-12 [Mid Point B Voltage]. Ensure that the four frequencies are set according to the following rules;  
 $E1-09 \leq E1-07 < E1-06 \leq E1-04$
- Parameter E1-03 is not reset when the drive is initialized using A1-03.

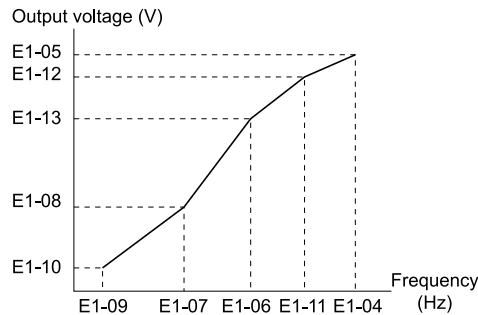


Figure 11.74 V/f Pattern

■ **E1-01: Input AC Supply Voltage**

No. (Hex.)	Name	Description	Default (Range)
E1-01 (0300)	Input AC Supply Voltage	<div style="display: flex; justify-content: space-between; font-size: small;"> <span>V/f</span> <span>CL-V/f</span> <span>OLV</span> <span>CLV</span> <span>AOLV</span> <span>OLV/PM</span> <span>AOLV/PM</span> <span>CLV/PM</span> <span>EZOLV</span> </div> Sets the drive input voltage.	200 V Class: 230 V, 400 V: 400 V (200 V Class: 155 to 255 V, 400 V Class: 310 to 510 V)

**NOTICE:** Set this parameter to align with the drive input voltage (not motor voltage). The protective features of the drive will not function if this parameter is incorrect. Failure to obey will cause incorrect drive operation.

**Values Related to the Drive Input Voltage**

The value set in E1-01 is the base value used for the motor protective functions in Table 11.48. With a 400 V class drive, the detection level changes for some motor protective functions.

Table 11.48 Values Related to the Drive Input Voltage

Voltage	E1-01 Setting	Approximate Values				
		ov Detection Level	BTR Operation Level (rr Detection Level) *1	L2-05 [Undervoltage Detection Lvl (Uv1)]	L2-11 [KEB DC Bus Voltage Setpoint]	L3-17 [DC Bus Regulation Level]
200 V class	All settings	410 V	394 V	190 V	260 V	375 V
400 V class	Setting value ≥ 400 V	820 V	788 V	380 V	500 V	750 V
	Setting value < 400 V	820 V	788 V	350 V	460 V	750 V

\*1 This is the protection function enabled in drives with built-in braking transistors. These values show the level that will trigger the built-in braking transistor. Refer to “YASKAWA AC Drive 72060001 Series Option Braking Unit and Braking Resistor Unit Installation Manual (TOBPC72060001)” for more information.

■ **E1-03: V/f Pattern Selection**

No. (Hex.)	Name	Description	Default (Range)
E1-03 (0302)	V/f Pattern Selection	<div style="display: flex; justify-content: space-between; font-size: small;"> <span>V/f</span> <span>CL-V/f</span> <span>OLV</span> <span>CLV</span> <span>AOLV</span> <span>OLV/PM</span> <span>AOLV/PM</span> <span>CLV/PM</span> <span>EZOLV</span> </div> Sets the V/f pattern for the drive and motor. You can use one of the preset patterns or you can make a custom pattern.	F (Determined by A1-02)

## 11.6 E: Motor Parameters

### Note:

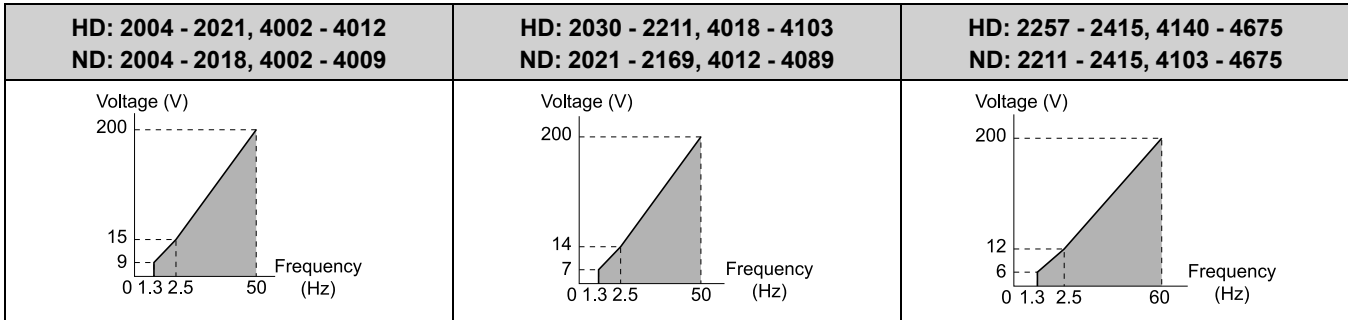
- When  $A1-02 = 2$  [Control Method Selection = Open Loop Vector Control], settings 0 through E are not available.
- Set the correct V/f pattern for the application and operation area. An incorrect V/f pattern can decrease motor torque and increase current from overexcitation.
- Parameter  $A1-03$  [Initialize Parameters] will not initialize the value  $E1-03$ .

### 0 : Constant Trq\_50Hz base\_50Hz max

Use this constant torque pattern for general applications. Use this pattern when the load torque is constant and there is no rotation speed. For example, linear conveyor systems.

### Note:

The voltage values in the figures are for 200 V class drives. Multiply the values by 2 for 400 V class drives.

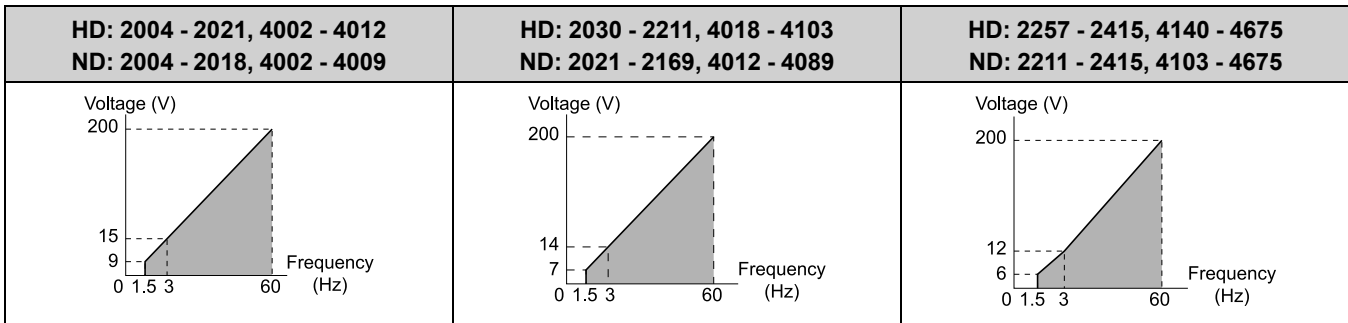


### 1 : Const Trq, 60Hz base, 60Hz max

Use this constant torque pattern for general applications. Use this pattern when the load torque is constant and there is no rotation speed. For example, linear conveyor systems.

### Note:

The voltage values in the figures are for 200 V class drives. Multiply the values by 2 for 400 V class drives.

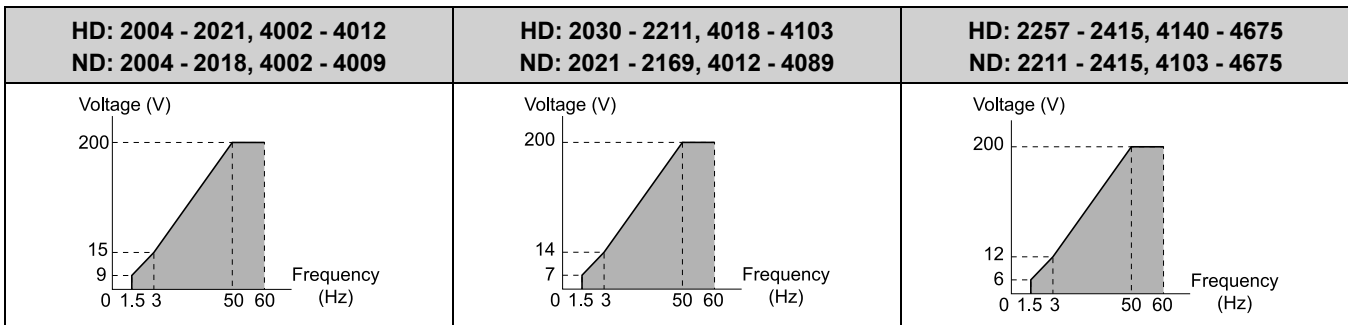


### 2 : High Freq, 50 Hz base, 60 Hz max

Use this constant torque pattern for general applications. Use this pattern when the load torque is constant and there is no rotation speed. For example, linear conveyor systems.

### Note:

The voltage values in the figures are for 200 V class drives. Multiply the values by 2 for 400 V class drives.



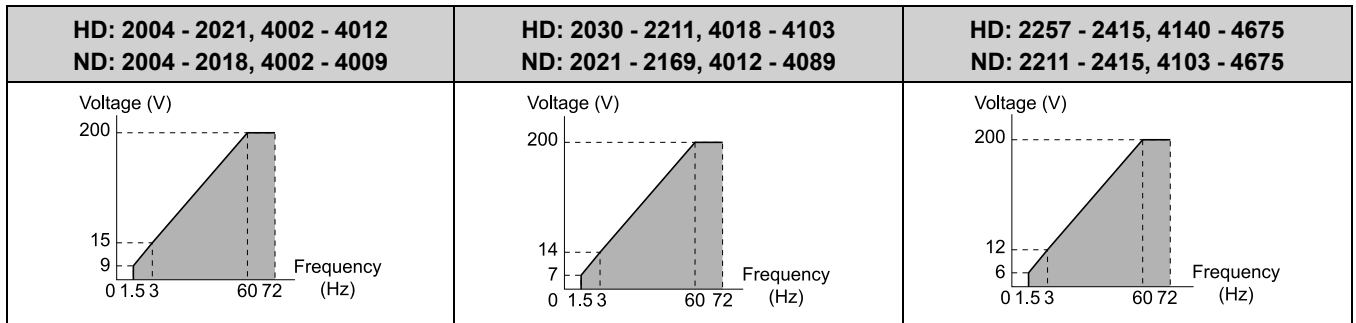
### 3 : High Freq, 60 Hz base, 72 Hz max

Use this constant torque pattern for general applications. Use this pattern when the load torque is constant and there is no rotation speed. For example, linear conveyor systems.



**Note:**

The voltage values in the figures are for 200 V class drives. Multiply the values by 2 for 400 V class drives.

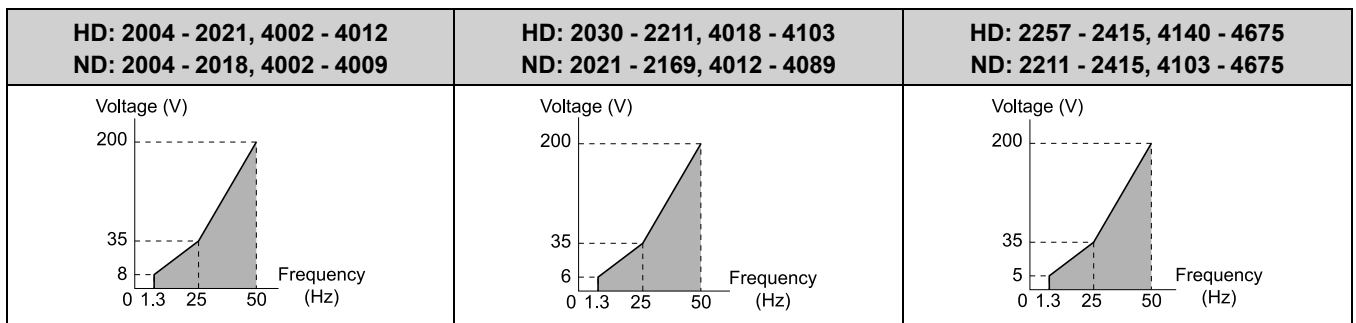


**4 : VT, 50Hz, 65% Vmid reduction**

Use this derated torque pattern for torque loads proportional to three times the rotation speed. For example, fans and pumps.

**Note:**

The voltage values in the figures are for 200 V class drives. Multiply the values by 2 for 400 V class drives.

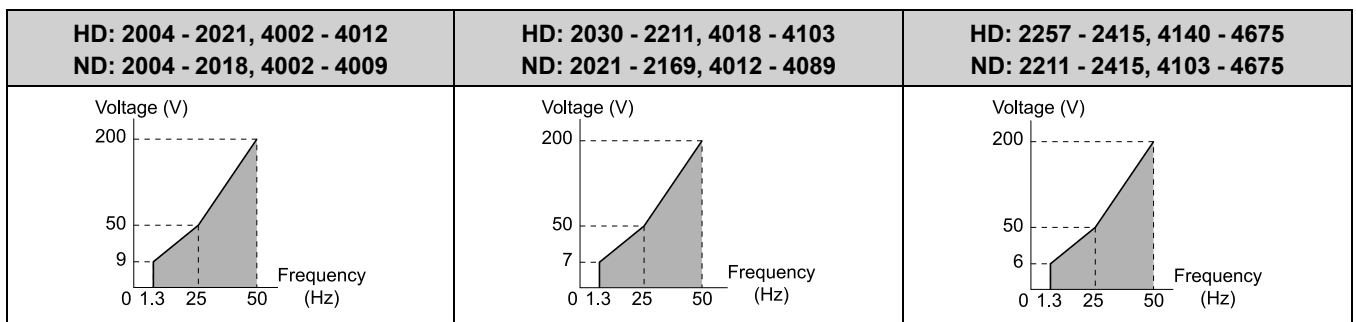


**5 : VT, 50Hz, 50% Vmid reduction**

Use this derated torque pattern for torque loads proportional to two times the rotation speed. For example, fans and pumps.

**Note:**

The voltage values in the figures are for 200 V class drives. Multiply the values by 2 for 400 V class drives.



**6 : VT, 60 Hz, 65% Vmid reduction**

Use this derated torque pattern for torque loads proportional to three times the rotation speed. For example, fans and pumps.

**Note:**

The voltage values in the figures are for 200 V class drives. Multiply the values by 2 for 400 V class drives.

## 11.6 E: Motor Parameters

HD: 2004 - 2021, 4002 - 4012 ND: 2004 - 2018, 4002 - 4009	HD: 2030 - 2211, 4018 - 4103 ND: 2021 - 2169, 4012 - 4089	HD: 2257 - 2415, 4140 - 4675 ND: 2211 - 2415, 4103 - 4675

### 7 : VT, 60 Hz, 50% Vmid reduction

Use this derated torque pattern for torque loads proportional to two times the rotation speed. For example, fans and pumps.

**Note:**

The voltage values in the figures are for 200 V class drives. Multiply the values by 2 for 400 V class drives.

HD: 2004 - 2021, 4002 - 4012 ND: 2004 - 2018, 4002 - 4009	HD: 2030 - 2211, 4018 - 4103 ND: 2021 - 2169, 4012 - 4089	HD: 2257 - 2415, 4140 - 4675 ND: 2211 - 2415, 4103 - 4675

### 8 : High Trq, 50Hz, 25% Vmin boost

Use this pattern when moderate torque is necessary during start up.

Select this pattern only in these conditions:

- The wiring distance between the drive and motor is 150 m (492.1 ft.) minimum.
- There is an AC reactor connected to the drive output.

**Note:**

The voltage values in the figures are for 200 V class drives. Multiply the values by 2 for 400 V class drives.

HD: 2004 - 2021, 4002 - 4012 ND: 2004 - 2018, 4002 - 4009	HD: 2030 - 2211, 4018 - 4103 ND: 2021 - 2169, 4012 - 4089	HD: 2257 - 2415, 4140 - 4675 ND: 2211 - 2415, 4103 - 4675

### 9 : High Trq, 50Hz, 65% Vmin boost

Use this pattern when high torque is necessary during start up.

Select this pattern only in these conditions:

- The wiring distance between the drive and motor is 150 m (492.1 ft.) minimum.
- There is an AC reactor connected to the drive output.

**Note:**

The voltage values in the figures are for 200 V class drives. Multiply the values by 2 for 400 V class drives.

HD: 2004 - 2021, 4002 - 4012 ND: 2004 - 2018, 4002 - 4009	HD: 2030 - 2211, 4018 - 4103 ND: 2021 - 2169, 4012 - 4089	HD: 2257 - 2415, 4140 - 4675 ND: 2211 - 2415, 4103 - 4675

**A : High Trq, 60 Hz, 25% Vmin boost**

Use this pattern when moderate torque is necessary during start up.

Select this pattern only in these conditions:

- The wiring distance between the drive and motor is 150 m (492.1 ft.) minimum.
- There is an AC reactor connected to the drive output.

**Note:**

The voltage values in the figures are for 200 V class drives. Multiply the values by 2 for 400 V class drives.

HD: 2004 - 2021, 4002 - 4012 ND: 2004 - 2018, 4002 - 4009	HD: 2030 - 2211, 4018 - 4103 ND: 2021 - 2169, 4012 - 4089	HD: 2257 - 2415, 4140 - 4675 ND: 2211 - 2415, 4103 - 4675

**B : High Trq, 60 Hz, 65% Vmin boost**

Use this pattern when high torque is necessary during start up.

Select this pattern only in these conditions:

- The wiring distance between the drive and motor is 150 m (492.1 ft.) minimum.
- There is an AC reactor connected to the drive output.

**Note:**

The voltage values in the figures are for 200 V class drives. Multiply the values by 2 for 400 V class drives.

HD: 2004 - 2021, 4002 - 4012 ND: 2004 - 2018, 4002 - 4009	HD: 2030 - 2211, 4018 - 4103 ND: 2021 - 2169, 4012 - 4089	HD: 2257 - 2415, 4140 - 4675 ND: 2211 - 2415, 4103 - 4675

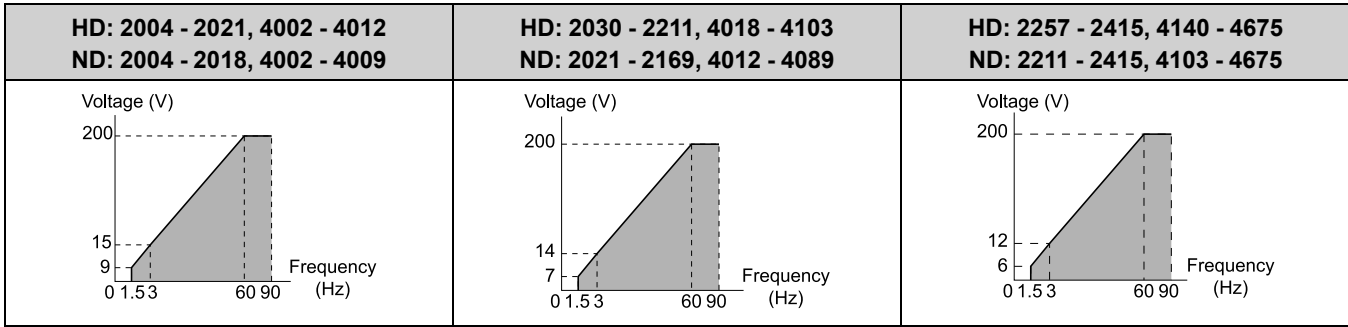
**C : High Freq, 60 Hz base, 90 Hz max**

Use this constant output pattern to rotate motors at more than 60 Hz. Output voltage is constant when you operate at more than 60 Hz.

**Note:**

The voltage values in the figures are for 200 V class drives. Multiply the values by 2 for 400 V class drives.

## 11.6 E: Motor Parameters

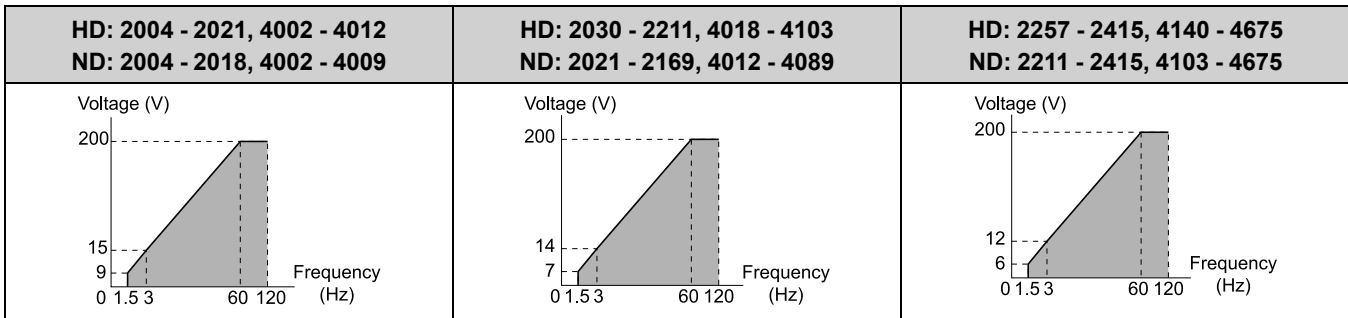


### D : High Freq, 60 Hz base, 120 Hz max

Use this constant output pattern to rotate motors at more than 60 Hz. Output voltage is constant when you operate at more than 60 Hz.

**Note:**

The voltage values in the figures are for 200 V class drives. Multiply the values by 2 for 400 V class drives.

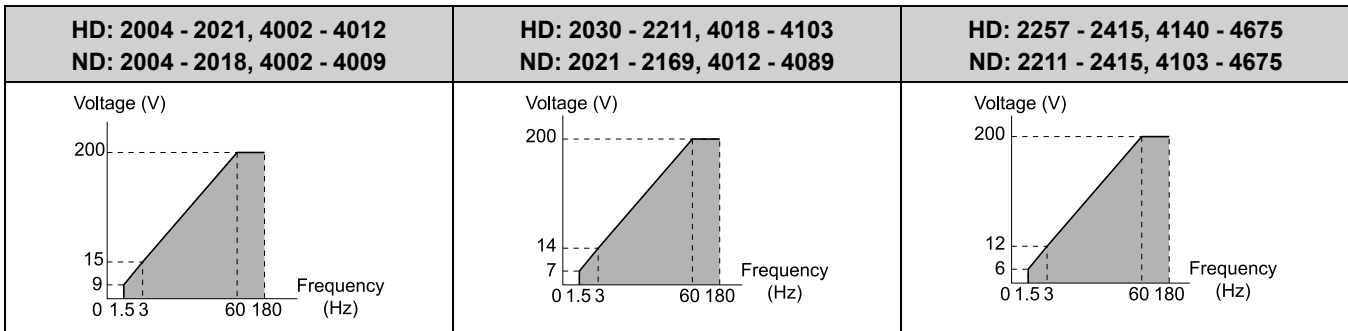


### E : High Freq, 60 Hz base, 180 Hz max

Use this constant output pattern to rotate motors at more than 60 Hz. Output voltage is constant when you operate at more than 60 Hz.

**Note:**

The voltage values in the figures are for 200 V class drives. Multiply the values by 2 for 400 V class drives.



### F : Custom

Set E1-04 to E1-13 [V/f Pattern for Motor 1] to set the values for this custom pattern.

The default settings are the same as setting value 1 [Const Trq, 60Hz base, 60Hz max].

#### ■ E1-04: Maximum Output Frequency

No. (Hex.)	Name	Description	Default (Range)
E1-04 (0303)	Maximum Output Frequency	<span>V/f</span> <span>CL-V/f</span> <span>OLV</span> <span>CLV</span> <span>AOLV</span> <span>OLV/PM</span> <span>AOLV/PM</span> <span>CLV/PM</span> <span>EZOLV</span> Sets the maximum output frequency for the V/f pattern.	Determined by A1-02 and E5-01 (Determined by A1-02 and E5-01)

### ■ E1-05: Maximum Output Voltage

No. (Hex.)	Name	Description	Default (Range)
E1-05 (0304)	Maximum Output Voltage	<b>V/f</b> <b>CL-V/f</b> <b>OLV</b> <b>CLV</b> <b>AOLV</b> <b>OLV/PM</b> <b>AOLV/PM</b> <b>CLV/PM</b> <b>EZOLV</b> Sets the maximum output voltage for the V/f pattern.	Determined by A1-02 (200 V Class: 0.0 - 255.0 V, 400 V Class: 0.0 - 510.0 V)

### ■ E1-06: Base Frequency

No. (Hex.)	Name	Description	Default (Range)
E1-06 (0305)	Base Frequency	<b>V/f</b> <b>CL-V/f</b> <b>OLV</b> <b>CLV</b> <b>AOLV</b> <b>OLV/PM</b> <b>AOLV/PM</b> <b>CLV/PM</b> <b>EZOLV</b> Sets the base frequency for the V/f pattern.	Determined by A1-02 and E5-01 (0.0 - E1-04)

### ■ E1-07: Mid Point A Frequency

No. (Hex.)	Name	Description	Default (Range)
E1-07 (0306)	Mid Point A Frequency	<b>V/f</b> <b>CL-V/f</b> <b>OLV</b> <b>CLV</b> <b>AOLV</b> <b>OLV/PM</b> <b>AOLV/PM</b> <b>CLV/PM</b> <b>EZOLV</b> Sets a middle output frequency for the V/f pattern.	Determined by A1-02 (0.0 - E1-04)

### ■ E1-08: Mid Point A Voltage

No. (Hex.)	Name	Description	Default (Range)
E1-08 (0307)	Mid Point A Voltage	<b>V/f</b> <b>CL-V/f</b> <b>OLV</b> <b>CLV</b> <b>AOLV</b> <b>OLV/PM</b> <b>AOLV/PM</b> <b>CLV/PM</b> <b>EZOLV</b> Sets a middle output voltage for the V/f pattern.	Determined by A1-02, C6-01 and o2-04 (200 V Class: 0.0 to 255.0 V, 400 V Class: 0.0 to 510.0 V)

**Note:**

Default setting is determined by A1-02 [Control Method Selection], C6-01 [Normal / Heavy Duty Selection], and o2-04 [Drive Model Selection].

### ■ E1-09: Minimum Output Frequency

No. (Hex.)	Name	Description	Default (Range)
E1-09 (0308)	Minimum Output Frequency	<b>V/f</b> <b>CL-V/f</b> <b>OLV</b> <b>CLV</b> <b>AOLV</b> <b>OLV/PM</b> <b>AOLV/PM</b> <b>CLV/PM</b> <b>EZOLV</b> Sets the minimum output frequency for the V/f pattern.	Determined by A1-02 and E5-01 (Determined by A1-02, E1-04, and E5-01)

### ■ E1-10: Minimum Output Voltage

No. (Hex.)	Name	Description	Default (Range)
E1-10 (0309)	Minimum Output Voltage	<b>V/f</b> <b>CL-V/f</b> <b>OLV</b> <b>CLV</b> <b>AOLV</b> <b>OLV/PM</b> <b>AOLV/PM</b> <b>CLV/PM</b> <b>EZOLV</b> Sets the minimum output voltage for the V/f pattern.	Determined by A1-02 (200 V Class: 0.0 - 255.0 V, 400 V Class: 0.0 - 510.0 V)

■ **E1-11: Mid Point B Frequency**

No. (Hex.)	Name	Description	Default (Range)
E1-11 (030A) Expert	Mid Point B Frequency	<b>V/f</b> <b>CL-V/f</b> <b>OLV</b> <b>CLV</b> <b>AOLV</b> <b>OLV/PM</b> <b>AOLV/PM</b> <b>CLV/PM</b> <b>EZOLV</b> Sets a middle output frequency for the V/f pattern.	0.0 Hz (0.0 - E1-04)

**Note:**

Set this parameter to 0.0 to disable the function.

■ **E1-12: Mid Point B Voltage**

No. (Hex.)	Name	Description	Default (Range)
E1-12 (030B) Expert	Mid Point B Voltage	<b>V/f</b> <b>CL-V/f</b> <b>OLV</b> <b>CLV</b> <b>AOLV</b> <b>OLV/PM</b> <b>AOLV/PM</b> <b>CLV/PM</b> <b>EZOLV</b> Sets a middle point voltage for the V/f pattern.	0.0 V (200 V Class: 0.0 - 255.0 V, 400 V Class: 0.0 - 510.0 V)

**Note:**

Set this parameter to 0.0 to disable the function.

■ **E1-13: Base Voltage**

No. (Hex.)	Name	Description	Default (Range)
E1-13 (030C) Expert	Base Voltage	<b>V/f</b> <b>CL-V/f</b> <b>OLV</b> <b>CLV</b> <b>AOLV</b> <b>OLV/PM</b> <b>AOLV/PM</b> <b>CLV/PM</b> <b>EZOLV</b> Sets the base voltage for the V/f pattern.	0.0 V (200 V Class: 0.0 - 255.0 V, 400 V Class: 0.0 - 510.0 V)

**Note:**

- The setting value of E1-13 = E1-05 [Maximum Output Voltage] after you do Auto-Tuning.
- When E1-13 = 0.0, use the value of E1-05 to control the voltage.

◆ **E2: Motor Parameters**

E2 parameters [Motor Parameters] are used to set induction motor data. To switch drive operation from one motor to another motor, configure the first motor (motor 1).

Performing Auto-Tuning automatically sets the E2 parameters to the optimal values. If Auto-Tuning cannot be performed, set the E2 parameters manually.

**Note:**

If A1-02 [Control Method Selection] is set to the following control modes, the keypad does not display E2-xx.

- 5 [PM Open Loop Vector]
- 6 [PM Advanced Open Loop Vector]
- 7 [PM Closed Loop Vector]
- 8 [EZ Vector Control]

■ **E2-01: Motor Rated Current (FLA)**

No. (Hex.)	Name	Description	Default (Range)
E2-01 (030E)	Motor Rated Current (FLA)	<b>V/f</b> <b>CL-V/f</b> <b>OLV</b> <b>CLV</b> <b>AOLV</b> <b>OLV/PM</b> <b>AOLV/PM</b> <b>CLV/PM</b> <b>EZOLV</b> Sets the motor rated current in amps.	Determined by o2-04 and C6-01 (10% to 200% of the drive rated current)

**Note:**

- If E2-01 < E2-03 [Motor No-Load Current] the drive will detect oPE02 [Parameter Range Setting Error].
- The default settings and setting ranges are in these units:  
 -0.01 A: 2004 to 2042, 4002 to 4023  
 -0.1 A: 2056 to 2415, 4031 to 4675

The value set for *E2-01* becomes the reference value for motor protection, the torque limit, and torque control. Enter the motor rated current as written on the motor nameplate. The value of *E2-01* is automatically set to the value input for “Motor Rated Current” by the Auto-Tuning process.

### ■ E2-02: Motor Rated Slip

No. (Hex.)	Name	Description	Default (Range)
E2-02 (030F)	Motor Rated Slip	<input type="checkbox"/> V/f <input type="checkbox"/> CL-V/f <input type="checkbox"/> OLV <input type="checkbox"/> CLV <input type="checkbox"/> AOLV <input type="checkbox"/> OLV/PM <input type="checkbox"/> AOLV/PM <input type="checkbox"/> CLV/PM <input type="checkbox"/> EZOLV Sets motor rated slip.	Determined by o2-04, C6-01 (0.000 - 20.000 Hz)

This parameter value becomes the base slip compensation value. The drive automatically sets this parameter during Auto-Tuning. When you cannot do Auto-Tuning, calculate the motor rated slip with the information on the motor nameplate and this formula:

$$E2-02 = f - (n \times p) / 120$$

- f: Motor rated frequency (Hz)
- n: Rated motor speed ( $\text{min}^{-1}$  (r/min))
- p: Number of motor poles

### ■ E2-03: Motor No-Load Current

No. (Hex.)	Name	Description	Default (Range)
E2-03 (0310)	Motor No-Load Current	<input type="checkbox"/> V/f <input type="checkbox"/> CL-V/f <input type="checkbox"/> OLV <input type="checkbox"/> CLV <input type="checkbox"/> AOLV <input type="checkbox"/> OLV/PM <input type="checkbox"/> AOLV/PM <input type="checkbox"/> CLV/PM <input type="checkbox"/> EZOLV Sets the no-load current for the motor in amps when operating at the rated frequency and the no-load voltage.	Determined by o2-04 and C6-01 (0 to E2-01)

**Note:**

The default settings and setting ranges are in these units:

- 0.01 A: 2004 to 2042, 4002 to 4023
- 0.1 A: 2056 to 2415, 4031 to 4675

The drive automatically sets this parameter during Auto-Tuning. When you cannot do Auto-Tuning, you can also use the motor no-load current on the motor test report to enter this value manually. Contact the motor manufacturer to receive a copy of the motor test report.

**Note:**

The default setting of the no-load current is for operation with a 4-pole motor recommended by Yaskawa.

### ■ E2-04: Motor Pole Count

No. (Hex.)	Name	Description	Default (Range)
E2-04 (0311)	Motor Pole Count	<input type="checkbox"/> V/f <input type="checkbox"/> CL-V/f <input type="checkbox"/> OLV <input type="checkbox"/> CLV <input type="checkbox"/> AOLV <input type="checkbox"/> OLV/PM <input type="checkbox"/> AOLV/PM <input type="checkbox"/> CLV/PM <input type="checkbox"/> EZOLV Sets the number of motor poles.	4 (2 - 120)

**Note:**

- When *A1-02* = 0, 1, 3 [Control Method Selection = V/f, CL-V/f, CLV], the maximum value is 120.
- When *A1-02* = 2, 4 [OLV, AOLV], the maximum value is 48.

Auto-Tuning automatically sets this parameter to the value of [Number of Motor Poles].

### ■ E2-05: Motor Line-to-Line Resistance

No. (Hex.)	Name	Description	Default (Range)
E2-05 (0312)	Motor Line-to-Line Resistance	<input type="checkbox"/> V/f <input type="checkbox"/> CL-V/f <input type="checkbox"/> OLV <input type="checkbox"/> CLV <input type="checkbox"/> AOLV <input type="checkbox"/> OLV/PM <input type="checkbox"/> AOLV/PM <input type="checkbox"/> CLV/PM <input type="checkbox"/> EZOLV Sets the line-to-line resistance for the motor stator windings.	Determined by o2-04 and C6-01 (0.000 - 65.000 Ω)

**Note:**

This value is the motor line-to-line resistance. Do not set this parameter with the single-phase resistance.

Auto-Tuning automatically sets this parameter. If you cannot do Auto-Tuning, use the test report from the motor manufacturer. You can calculate the motor line-to-line resistance with one of these formulas:

## 11.6 E: Motor Parameters

- E-type insulation: [the resistance value ( $\Omega$ ) shown on the test report at 75 °C]  $\times$  0.92
- B-type insulation: [the resistance value ( $\Omega$ ) shown on the test report at 75 °C]  $\times$  0.92
- F-type insulation: [the resistance value ( $\Omega$ ) shown on the test report at 115 °C]  $\times$  0.87

### ■ E2-06: Motor Leakage Inductance

No. (Hex.)	Name	Description	Default (Range)
E2-06 (0313)	Motor Leakage Inductance	<div style="display: flex; justify-content: space-between; font-size: 0.8em; margin-bottom: 5px;"> <span>V/f</span> <span>CL-V/f</span> <span>OLV</span> <span>CLV</span> <span>AOLV</span> <span>OLV/PM</span> <span>AOLV/PM</span> <span>CLV/PM</span> <span>EZOLV</span> </div> Sets the voltage drop from motor leakage inductance when the motor is operating at the rated frequency and rated current. This value is a percentage of Motor Rated Voltage.	Determined by o2-04 and C6-01 (0.0 - 60.0%)

The drive automatically sets this parameter during Auto-Tuning.

#### Note:

The motor nameplate does not usually show the quantity of voltage drop. If you do not know the value of the motor leakage inductance, contact the motor manufacturer to receive a copy of the motor test report.

### ■ E2-07: Motor Saturation Coefficient 1

No. (Hex.)	Name	Description	Default (Range)
E2-07 (0314)	Motor Saturation Coefficient 1	<div style="display: flex; justify-content: space-between; font-size: 0.8em; margin-bottom: 5px;"> <span>V/f</span> <span>CL-V/f</span> <span>OLV</span> <span>CLV</span> <span>AOLV</span> <span>OLV/PM</span> <span>AOLV/PM</span> <span>CLV/PM</span> <span>EZOLV</span> </div> Set the motor iron-core saturation coefficient when the magnetic flux is 50%.	0.50 (0.00 - 0.50)

Rotational Auto-Tuning automatically sets this parameter. The drive uses this coefficient when it operates with constant output.

### ■ E2-08: Motor Saturation Coefficient 2

No. (Hex.)	Name	Description	Default (Range)
E2-08 (0315)	Motor Saturation Coefficient 2	<div style="display: flex; justify-content: space-between; font-size: 0.8em; margin-bottom: 5px;"> <span>V/f</span> <span>CL-V/f</span> <span>OLV</span> <span>CLV</span> <span>AOLV</span> <span>OLV/PM</span> <span>AOLV/PM</span> <span>CLV/PM</span> <span>EZOLV</span> </div> Sets the motor iron-core saturation coefficient at 75% of the magnetic flux.	0.75 (E2-07 - 0.75)

Rotational Auto-Tuning automatically sets this parameter. The drive uses this coefficient when it operates with constant output.

### ■ E2-09: Motor Mechanical Loss

No. (Hex.)	Name	Description	Default (Range)
E2-09 (0316) Expert	Motor Mechanical Loss	<div style="display: flex; justify-content: space-between; font-size: 0.8em; margin-bottom: 5px;"> <span>V/f</span> <span>CL-V/f</span> <span>OLV</span> <span>CLV</span> <span>AOLV</span> <span>OLV/PM</span> <span>AOLV/PM</span> <span>CLV/PM</span> <span>EZOLV</span> </div> Sets the mechanical loss of the motor. Motor rated power (kw) = 100.0%. Usually it is not necessary to change this setting.	0.0% (0.0 - 10.0%)

Adjust this parameter in these conditions. The drive adds the configured mechanical loss to the torque reference value as a torque compensation value:

- There is a large quantity of torque loss from motor bearing friction.
- There is a large quantity of torque loss in fans and pumps.

### ■ E2-10: Motor Iron Loss

No. (Hex.)	Name	Description	Default (Range)
E2-10 (0317)	Motor Iron Loss	<div style="display: flex; justify-content: space-between; font-size: 0.8em; margin-bottom: 5px;"> <span>V/f</span> <span>CL-V/f</span> <span>OLV</span> <span>CLV</span> <span>AOLV</span> <span>OLV/PM</span> <span>AOLV/PM</span> <span>CLV/PM</span> <span>EZOLV</span> </div> Sets the motor iron loss.	Determined by o2-04 and C6-01 (0 - 65535 W)



## ■ E2-11: Motor Rated Power (kW)

No. (Hex.)	Name	Description	Default (Range)
E2-11 (0318)	Motor Rated Power (kW)	<div style="display: flex; justify-content: space-between; font-size: 0.8em; margin-bottom: 5px;"> <span>V/f</span> <span>CL-V/f</span> <span>OLV</span> <span>CLV</span> <span>AOLV</span> <span>OLV/PM</span> <span>AOLV/PM</span> <span>CLV/PM</span> <span>EZOLV</span> </div> Sets the motor rated power in 0.01 kW increments. (1 HP = 0.746 kW)	Determined by o2-04 and C6-01 (0.00 - 650.00 kW)

The drive automatically sets this parameter to the value input for “Motor Rated Power” during Auto-Tuning.

### Note:

- When the maximum applicable motor output  $\leq 300$  kW, the drive uses 0.01 kW units.
- When the maximum applicable motor output  $> 300$  kW, the drive uses 0.1 kW units.
- The maximum applicable motor output changes when the value for C6-01 [Normal / Heavy Duty Selection] changes.

## ◆ E3: V/f Pattern for Motor 2

E3 parameters [V/f Pattern for Motor 2] set the control mode and V/f pattern used for motor 2.

### Note:

V/f preset patterns equivalent to those set with E1-03 [V/f Pattern Selection] are not available for E3 parameters. Use E3-04 [Motor 2 Maximum Output Frequency] to E3-10 [Motor 2 Minimum Output Voltage] to manually set the V/f pattern.

## ■ Notes on Manually Setting V/f Patterns

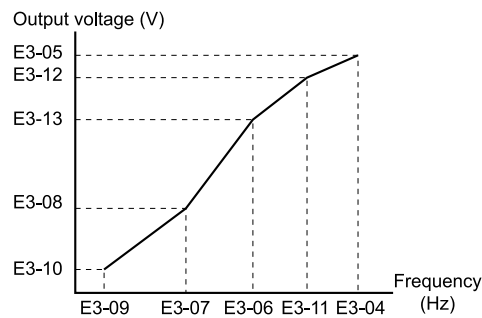


Figure 11.75 Motor 2 V/f Pattern Diagram

- To configure a linear V/f pattern at frequencies lower than E3-06 [Motor 2 Base Frequency], set E3-07 = E3-09 [Motor 2 Mid Point A Frequency = Motor 2 Minimum Output Frequency]. In this application, the drive ignores E1-08 [Mid Point A Voltage].
- Set the five frequencies as specified by these rules:  
 $E3-09 \leq E3-07 < E3-06 \leq E3-11 \leq E3-04$  [Motor 2 Minimum Output Frequency  $\leq$  Motor 2 Mid Point A Frequency  $<$  Motor 2 Base Frequency  $\leq$  Motor 2 Mid Point B Frequency  $\leq$  Motor 2 Maximum Output Frequency]  
 Incorrect settings will trigger oPE10 [V/f Data Setting Error].
- If E3-11 = 0.0 Hz, the drive will ignore the V/f pattern settings.
- When you use A1-03 [Initialize Parameters] to initialize the drive, the drive will reset the manually set values for E3-04 to E3-13 [Motor 2 Base Voltage] to default values.

## ■ E3-01: Motor 2 Control Mode Selection

No. (Hex.)	Name	Description	Default (Range)
E3-01 (0319)	Motor 2 Control Mode Selection	<div style="display: flex; justify-content: space-between; font-size: 0.8em; margin-bottom: 5px;"> <span>V/f</span> <span>CL-V/f</span> <span>OLV</span> <span>CLV</span> <span>AOLV</span> <span>OLV/PM</span> <span>AOLV/PM</span> <span>CLV/PM</span> <span>EZOLV</span> </div> Sets the control method for motor 2.	0 (0 - 3)

### Note:

- When you change this setting, the drive will set all parameters that are dependent on this parameter to their default settings.
- Parameter L1-01 [Motor Overload (oL1) Protection] sets the protection operation of oL1 [Motor Overload] the same as Motor 1.
- When you use parameter A1-03 [Initialize Parameters] to initialize the drive, this parameter is not reset.

### 0 : V/f Control

### 1 : V/f Control with Encoder

### 2 : Open Loop Vector

### 3 : Closed Loop Vector

#### ■ E3-04: Motor 2 Maximum Output Frequency

No. (Hex.)	Name	Description	Default (Range)
E3-04 (031A)	Motor 2 Maximum Output Frequency	<b>V/f</b> <b>CL-V/f</b> <b>OLV</b> <b>CLV</b> <b>AOLV</b> <b>OLV/PM</b> <b>AOLV/PM</b> <b>CLV/PM</b> <b>EZOLV</b> Set the maximum output frequency for the motor 2 V/f pattern.	Determined by E3-01 (40.0 - 590.0 Hz)

#### ■ E3-05: Motor 2 Maximum Output Voltage

No. (Hex.)	Name	Description	Default (Range)
E3-05 (031B)	Motor 2 Maximum Output Voltage	<b>V/f</b> <b>CL-V/f</b> <b>OLV</b> <b>CLV</b> <b>AOLV</b> <b>OLV/PM</b> <b>AOLV/PM</b> <b>CLV/PM</b> <b>EZOLV</b> Sets the maximum output voltage for the motor 2 V/f pattern.	Determined by E3-01 (200 V Class: 0.0 - 255.0 V, 400 V Class: 0.0 - 510.0 V)

#### ■ E3-06: Motor 2 Base Frequency

No. (Hex.)	Name	Description	Default (Range)
E3-06 (031C)	Motor 2 Base Frequency	<b>V/f</b> <b>CL-V/f</b> <b>OLV</b> <b>CLV</b> <b>AOLV</b> <b>OLV/PM</b> <b>AOLV/PM</b> <b>CLV/PM</b> <b>EZOLV</b> Sets the base frequency for the motor 2 V/f pattern.	Determined by E3-01 (0.0 - E3-04)

#### ■ E3-07: Motor 2 Mid Point A Frequency

No. (Hex.)	Name	Description	Default (Range)
E3-07 (031D)	Motor 2 Mid Point A Frequency	<b>V/f</b> <b>CL-V/f</b> <b>OLV</b> <b>CLV</b> <b>AOLV</b> <b>OLV/PM</b> <b>AOLV/PM</b> <b>CLV/PM</b> <b>EZOLV</b> Sets a middle output frequency for the motor 2 V/f pattern.	Determined by E3-01 (0.0 - E3-04)

#### ■ E3-08: Motor 2 Mid Point A Voltage

No. (Hex.)	Name	Description	Default (Range)
E3-08 (031E)	Motor 2 Mid Point A Voltage	<b>V/f</b> <b>CL-V/f</b> <b>OLV</b> <b>CLV</b> <b>AOLV</b> <b>OLV/PM</b> <b>AOLV/PM</b> <b>CLV/PM</b> <b>EZOLV</b> Sets a middle output voltage for the motor 2 V/f pattern.	Determined by E3-01 (200 V Class: 0.0 - 255.0 V, 400 V Class: 0.0 - 510.0 V)

#### ■ E3-09: Motor 2 Minimum Output Frequency

No. (Hex.)	Name	Description	Default (Range)
E3-09 (031F)	Motor 2 Minimum Output Frequency	<b>V/f</b> <b>CL-V/f</b> <b>OLV</b> <b>CLV</b> <b>AOLV</b> <b>OLV/PM</b> <b>AOLV/PM</b> <b>CLV/PM</b> <b>EZOLV</b> Sets the minimum output frequency for the motor 2 V/f pattern.	Determined by E3-01 (0.0 - E3-04)

#### ■ E3-10: Motor 2 Minimum Output Voltage

No. (Hex.)	Name	Description	Default (Range)
E3-10 (0320)	Motor 2 Minimum Output Voltage	<b>V/f</b> <b>CL-V/f</b> <b>OLV</b> <b>CLV</b> <b>AOLV</b> <b>OLV/PM</b> <b>AOLV/PM</b> <b>CLV/PM</b> <b>EZOLV</b> Sets the minimum output voltage for the motor 2 V/f pattern.	Determined by E3-01 (200 V Class: 0.0 - 255.0 V, 400 V Class: 0.0 - 510.0 V)

### ■ E3-11: Motor 2 Mid Point B Frequency

No. (Hex.)	Name	Description	Default (Range)
E3-11 (0345) Expert	Motor 2 Mid Point B Frequency	<b>V/f</b> <b>CL-V/f</b> <b>OLV</b> <b>CLV</b> AOLV OLV/PM AOLV/PM CLV/PM EZOLV Sets a middle output frequency for the motor 2 V/f pattern. Set this parameter to adjust the V/f pattern for the constant output range. Usually it is not necessary to change this setting.	0.0 Hz (0.0 - E3-04)

**Note:**

- Set this parameter to 0.0 to disable the function.
- When you initialize the drive, this parameter is reset to the default value.

### ■ E3-12: Motor 2 Mid Point B Voltage

No. (Hex.)	Name	Description	Default (Range)
E3-12 (0346) Expert	Motor 2 Mid Point B Voltage	<b>V/f</b> <b>CL-V/f</b> <b>OLV</b> <b>CLV</b> AOLV OLV/PM AOLV/PM CLV/PM EZOLV Sets a middle output voltage for the motor 2 V/f pattern. Set this parameter to adjust the V/f pattern for the constant output range. Usually it is not necessary to change this setting.	0.0 V (200 V Class: 0.0 - 255.0 V, 400 V Class: 0.0 - 510.0 V)

**Note:**

- Set this parameter to 0.0 to disable the function.
- When you initialize the drive, this parameter is reset to the default value.
- The setting value changes automatically when you do Auto-Tuning (rotational and stationary 1 or 2).

### ■ E3-13: Motor 2 Base Voltage

No. (Hex.)	Name	Description	Default (Range)
E3-13 (0347) Expert	Motor 2 Base Voltage	<b>V/f</b> <b>CL-V/f</b> <b>OLV</b> <b>CLV</b> AOLV OLV/PM AOLV/PM CLV/PM EZOLV Sets the base voltage for the motor 2 V/f pattern. Set this parameter to adjust the V/f pattern for the constant output range. Usually it is not necessary to change this setting.	0.0 V (200 V Class: 0.0 - 255.0 V, 400 V Class: 0.0 - 510.0 V)

**Note:**

- When you initialize the drive, this parameter is reset to the default value.
- The setting value changes automatically when you do Auto-Tuning (rotational and stationary 1 or 2).

## ◆ E4: Motor 2 Parameters

*E4 parameters [Motor 2 Parameters]* set induction motor data. To switch drive operation from one motor to a different motor, configure motor 2.

Auto-Tuning automatically sets the *E4 parameters* to the best values for the application. If you cannot do Auto-Tuning, set the *E4 parameters* manually.

**Note:**

*E3-xx* and *E4-xx* are available when *H1-xx* = 16 [*MFDI Function Select = Motor 2 Selection*].

### ■ E4-01: Motor 2 Rated Current

No. (Hex.)	Name	Description	Default (Range)
E4-01 (0321)	Motor 2 Rated Current	<b>V/f</b> <b>CL-V/f</b> <b>OLV</b> <b>CLV</b> AOLV OLV/PM AOLV/PM CLV/PM EZOLV Sets the motor rated current for motor 2 in amps.	Determined by o2-04 and C6-01 (10% to 200% of the drive rated current)

**Note:**

- If  $E4-01 \leq E4-03$  [*Motor 2 Rated No-Load Current*], the drive will detect *oPE02 [Parameter Range Setting Error]* will be detected.
- The default settings and setting ranges are in these units:
  - 0.01 A: 2004 to 2042, 4002 to 4023
  - 0.1 A: 2056 to 2415, 4031 to 4675

## 11.6 E: Motor Parameters

The value set for *E4-01* becomes the reference value for motor protection, the torque limit, and torque control. Enter the motor rated current written on the motor nameplate. Auto-Tuning automatically sets the value of *E4-01* to the value input for [Motor Rated Current].

### ■ E4-02: Motor 2 Rated Slip

No. (Hex.)	Name	Description	Default (Range)
E4-02 (0322)	Motor 2 Rated Slip	<input type="checkbox"/> V/f <input type="checkbox"/> CL-V/f <input type="checkbox"/> OLV <input type="checkbox"/> CLV <input type="checkbox"/> AOLV <input type="checkbox"/> OLV/PM <input type="checkbox"/> AOLV/PM <input type="checkbox"/> CLV/PM <input type="checkbox"/> EZOLV Sets the motor rated slip for motor 2.	Determined by o2-04 and C6-01 (0.000 - 20.000 Hz)

The value set in *E4-02* becomes the base slip compensation value. The drive sets this parameter during Rotational Auto-Tuning and Stationary Auto-Tuning. If you cannot do Auto-Tuning, use the information written on the motor nameplate and this formula to calculate the motor rated slip:

$$E4-02 = f - (n \times p) / 120$$

- f: Motor rated frequency (Hz)
- n: Rated motor speed ( $\text{min}^{-1}$  (r/min))
- p: Number of motor poles

### ■ E4-03: Motor 2 Rated No-Load Current

No. (Hex.)	Name	Description	Default (Range)
E4-03 (0323)	Motor 2 Rated No-Load Current	<input type="checkbox"/> V/f <input type="checkbox"/> CL-V/f <input type="checkbox"/> OLV <input type="checkbox"/> CLV <input type="checkbox"/> AOLV <input type="checkbox"/> OLV/PM <input type="checkbox"/> AOLV/PM <input type="checkbox"/> CLV/PM <input type="checkbox"/> EZOLV Sets the no-load current for motor 2 in amps when operating at the rated frequency and the no-load voltage.	Determined by o2-04 and C6-01 (0 to E4-01)

**Note:**

The default settings and setting ranges are in these units:

- 0.01 A: 2004 to 2042, 4002 to 4023
- 0.1 A: 2056 to 2415, 4031 to 4675

The drive sets this parameter during Rotational Auto-Tuning and Stationary Auto-Tuning. You can also enter the motor no-load current shown on the motor test report to *E4-03* manually. Contact the motor manufacturer to receive a copy of the motor test report.

**Note:**

The default setting of the no-load current is for a 4-pole motor recommended by Yaskawa.

### ■ E4-04: Motor 2 Motor Poles

No. (Hex.)	Name	Description	Default (Range)
E4-04 (0324)	Motor 2 Motor Poles	<input type="checkbox"/> V/f <input type="checkbox"/> CL-V/f <input type="checkbox"/> OLV <input type="checkbox"/> CLV <input type="checkbox"/> AOLV <input type="checkbox"/> OLV/PM <input type="checkbox"/> AOLV/PM <input type="checkbox"/> CLV/PM <input type="checkbox"/> EZOLV Sets the number of poles for motor 2.	4 (2 - 120)

Auto-Tuning automatically sets *E4-04* to the value input for [Number of Motor Poles].

### ■ E4-05: Motor 2 Line-to-Line Resistance

No. (Hex.)	Name	Description	Default (Range)
E4-05 (0325)	Motor 2 Line-to-Line Resistance	<input type="checkbox"/> V/f <input type="checkbox"/> CL-V/f <input type="checkbox"/> OLV <input type="checkbox"/> CLV <input type="checkbox"/> AOLV <input type="checkbox"/> OLV/PM <input type="checkbox"/> AOLV/PM <input type="checkbox"/> CLV/PM <input type="checkbox"/> EZOLV Sets the line-to-line resistance for the motor 2 stator windings.	Determined by o2-04 and C6-01 (0.000 - 65.000 $\Omega$ )

**Note:**

This value is the line-to-line resistance for motor 2. Do not use the single-phase resistance to set this parameter.

The drive automatically calculates this value when Auto-Tuning completes successfully. If you cannot do Auto-Tuning, get the test report from the motor manufacturer. To calculate the motor line-to-line resistance, use the information shown on the motor nameplate with one of these formulas:

- E-type insulation: the resistance value ( $\Omega$ ) shown on the test report at  $75\text{ }^\circ\text{C} \times 0.92$

- B-type insulation: the resistance value ( $\Omega$ ) shown on the test report at  $75\text{ }^{\circ}\text{C} \times 0.92$
- F-type insulation: the resistance value ( $\Omega$ ) shown on the test report at  $115\text{ }^{\circ}\text{C} \times 0.87$

#### ■ E4-06: Motor 2 Leakage Inductance

No. (Hex.)	Name	Description	Default (Range)
E4-06 (0326)	Motor 2 Leakage Inductance	<div style="display: flex; justify-content: space-between; font-size: 0.8em; margin-bottom: 5px;"> <span>V/f</span> <span>CL-V/f</span> <span>OLV</span> <span>CLV</span> <span>AOLV</span> <span>OLV/PM</span> <span>AOLV/PM</span> <span>CLV/PM</span> <span>EZOLV</span> </div> Sets the voltage drop from motor 2 leakage inductance as a percentage of Motor Rated Voltage when motor 2 operates at the rated frequency and rated current.	Determined by o2-04, C6-01 (0.0 - 60.0%)

The drive sets this parameter during Rotational Auto-Tuning and Stationary Auto-Tuning.

##### Note:

You cannot usually find the quantity of voltage drop on the motor nameplate. If you do not know the value of the motor 2 leakage inductance, get the test report from the motor manufacturer.

#### ■ E4-07: Motor 2 Saturation Coefficient 1

No. (Hex.)	Name	Description	Default (Range)
E4-07 (0343)	Motor 2 Saturation Coefficient 1	<div style="display: flex; justify-content: space-between; font-size: 0.8em; margin-bottom: 5px;"> <span>V/f</span> <span>CL-V/f</span> <span>OLV</span> <span>CLV</span> <span>AOLV</span> <span>OLV/PM</span> <span>AOLV/PM</span> <span>CLV/PM</span> <span>EZOLV</span> </div> Sets the motor 2 iron-core saturation coefficient at 50% of the magnetic flux.	0.50 (0.00 - 0.50)

The drive sets this parameter during Rotational Auto-Tuning. The drive uses this coefficient when it operates with constant output.

#### ■ E4-08: Motor 2 Saturation Coefficient 2

No. (Hex.)	Name	Description	Default (Range)
E4-08 (0344)	Motor 2 Saturation Coefficient 2	<div style="display: flex; justify-content: space-between; font-size: 0.8em; margin-bottom: 5px;"> <span>V/f</span> <span>CL-V/f</span> <span>OLV</span> <span>CLV</span> <span>AOLV</span> <span>OLV/PM</span> <span>AOLV/PM</span> <span>CLV/PM</span> <span>EZOLV</span> </div> Sets the motor 2 iron-core saturation coefficient at 75% of the magnetic flux.	0.75 (E4-07 - 0.75)

The drive sets this parameter during Rotational Auto-Tuning. The drive uses this value to operate the motor at constant output.

#### ■ E4-09: Motor 2 Mechanical Loss

No. (Hex.)	Name	Description	Default (Range)
E4-09 (033F) Expert	Motor 2 Mechanical Loss	<div style="display: flex; justify-content: space-between; font-size: 0.8em; margin-bottom: 5px;"> <span>V/f</span> <span>CL-V/f</span> <span>OLV</span> <span>CLV</span> <span>AOLV</span> <span>OLV/PM</span> <span>AOLV/PM</span> <span>CLV/PM</span> <span>EZOLV</span> </div> Sets the mechanical loss of motor 2. Motor rated power (kW) is 100%. Usually it is not necessary to change this setting.	0.0% (0.0 - 10.0%)

Adjust this parameter in these conditions. The drive adds the configured mechanical loss to the torque reference value as a torque compensation value:

- There is a large quantity of torque loss from motor bearing friction.
- There is a large quantity of torque loss in fans and pumps.

#### ■ E4-10: Motor 2 Iron Loss

No. (Hex.)	Name	Description	Default (Range)
E4-10 (0340)	Motor 2 Iron Loss	<div style="display: flex; justify-content: space-between; font-size: 0.8em; margin-bottom: 5px;"> <span>V/f</span> <span>CL-V/f</span> <span>OLV</span> <span>CLV</span> <span>AOLV</span> <span>OLV/PM</span> <span>AOLV/PM</span> <span>CLV/PM</span> <span>EZOLV</span> </div> Sets the motor iron loss for motor 2.	Determined by o2-04 and C6-01 (0 - 65535 W)

■ **E4-11: Motor 2 Rated Power**

No. (Hex.)	Name	Description	Default (Range)
E4-11 (0327)	Motor 2 Rated Power	<b>V/f</b> <b>CL-V/f</b> <b>OLV</b> <b>CLV</b> <b>AOLV</b> <b>OLV/PM</b> <b>AOLV/PM</b> <b>CLV/PM</b> <b>EZOLV</b> Sets the motor 2 rated power in 0.01 kW increments (1 HP = 0.746 kW).	Determined by o2-04 and C6-01 (0.00 - 650.00 kW)

Auto-Tuning automatically sets this parameter to the value input for [Motor Rated Power].

**Note:**

When the maximum applicable motor output < 300 kW, the drive uses 0.01 kW units. When the maximum applicable motor output > 300 kW, the drive uses 0.1 kW units.

The maximum applicable motor output changes when the value for C6-01 [Normal / Heavy Duty Selection] changes.

◆ **E5: PM Motor Settings**

E5 parameters are used to set PM motor data.

Set E5-01 to the motor code when using PM motors recommended by Yaskawa. E5 and other related motor parameters will be automatically set to the optimal values.

Perform Auto-Tuning for all other PM motors. If information from motor nameplates or test reports is available, the E5 parameters can be manually entered.

**Note:**

- The keypad displays E5-xx only when A1-02 = 5, 6, 7 [Control Method Selection = OLV/PM, AOLV/PM, CLV/PM].
- E5-xx parameters are not reset when the drive is initialized using parameter A1-03 [Initialize Parameters].

■ **E5-01: PM Motor Code Selection**

No. (Hex.)	Name	Description	Default (Range)
E5-01 (0329)	PM Motor Code Selection	<b>V/f</b> <b>CL-V/f</b> <b>OLV</b> <b>CLV</b> <b>AOLV</b> <b>OLV/PM</b> <b>AOLV/PM</b> <b>CLV/PM</b> <b>EZOLV</b> Sets the motor code for Yaskawa PM motors. The drive uses the motor code to set some parameters to their correct settings automatically.	Determined by A1-02, o2-04, and C6-01 (0000 - FFFF)

**Note:**

- If the drive hunts or shows an alarm after you use a motor code, use the keypad to enter the value shown on the nameplate to E5-xx.
- When you use a PM motor other than a Yaskawa SMRA, SSR1, or SST4 series, set E5-01 = FFFF.

Figure 11.76 gives information about the motor code setting digits.

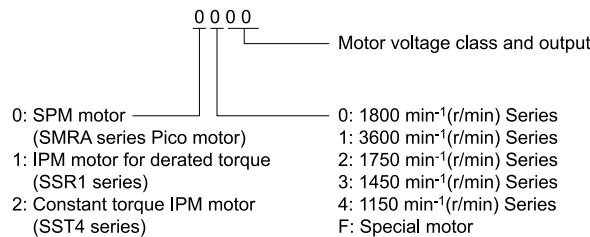


Figure 11.76 PM Motor Code

■ **E5-02: PM Motor Rated Power (kW)**

No. (Hex.)	Name	Description	Default (Range)
E5-02 (032A)	PM Motor Rated Power (kW)	<b>V/f</b> <b>CL-V/f</b> <b>OLV</b> <b>CLV</b> <b>AOLV</b> <b>OLV/PM</b> <b>AOLV/PM</b> <b>CLV/PM</b> <b>EZOLV</b> Sets the PM motor rated power.	Determined by E5-01 (0.10 - 650.00 kW)

These types of Auto-Tuning will automatically set this parameter:

- PM Motor Parameter Settings
- PM Stationary Auto-Tuning
- PM Rotational Auto-Tuning

### ■ E5-03: PM Motor Rated Current (FLA)

No. (Hex.)	Name	Description	Default (Range)
E5-03 (032B)	PM Motor Rated Current (FLA)	<span>V/f</span> <span>CL-V/f</span> <span>OLV</span> <span>CLV</span> <span>AOLV</span> <span>OLV/PM</span> <span>AOLV/PM</span> <span>CLV/PM</span> <span>EZOLV</span> Sets the PM motor rated current (FLA).	Determined by E5-01 (10% to 200% of the drive rated current)

**Note:**

When the drive model changes, the display units for this parameter also change.

•0.01 A: 2004 to 2042, 4002 to 4023

•0.1 A: 2056 to 2415, 4031 to 4675

The drive automatically sets *E5-03* to the value input for “PM Motor Rated Current” after you do these types of Auto-Tuning:

- PM Motor Parameter Settings
- PM Stationary Auto-Tuning
- PM StaTun for Stator Resistance
- PM Rotational Auto-Tuning

### ■ E5-04: PM Motor Pole Count

No. (Hex.)	Name	Description	Default (Range)
E5-04 (032C)	PM Motor Pole Count	<span>V/f</span> <span>CL-V/f</span> <span>OLV</span> <span>CLV</span> <span>AOLV</span> <span>OLV/PM</span> <span>AOLV/PM</span> <span>CLV/PM</span> <span>EZOLV</span> Sets the number of PM motor poles.	Determined by E5-01 (2 - 120)

**Note:**

•When *A1-02* = 7 [Control Method Selection = *CLV/PM*], the maximum value is 120.

•When *A1-02* = 5, 6 or 8 [*OLV/PM*, *AOLV/PM* or *EZOLV*], the maximum value is 48.

These types of Auto-Tuning will automatically set this parameter to the value of [Number of Motor Poles]:

- PM Motor Parameter Settings
- PM Stationary Auto-Tuning
- PM Rotational Auto-Tuning

### ■ E5-05: PM Motor Resistance (ohms/phase)

No. (Hex.)	Name	Description	Default (Range)
E5-05 (032D)	PM Motor Resistance (ohms/phase)	<span>V/f</span> <span>CL-V/f</span> <span>OLV</span> <span>CLV</span> <span>AOLV</span> <span>OLV/PM</span> <span>AOLV/PM</span> <span>CLV/PM</span> <span>EZOLV</span> Sets the resistance per phase of the PM motors. Set 50% of the line-to-line resistance.	Determined by E5-01 (0.000 - 65.000 Ω)

PM motor Auto-Tuning automatically sets this parameter to the value of [PM Motor Stator Resistance].

**Note:**

Do not change the setting calculated by Auto-Tuning unless it is necessary.

### ■ E5-06: PM d-axis Inductance (mH/phase)

No. (Hex.)	Name	Description	Default (Range)
E5-06 (032E)	PM d-axis Inductance (mH/phase)	<span>V/f</span> <span>CL-V/f</span> <span>OLV</span> <span>CLV</span> <span>AOLV</span> <span>OLV/PM</span> <span>AOLV/PM</span> <span>CLV/PM</span> <span>EZOLV</span> Sets the PM motor d-axis inductance.	Determined by E5-01 (0.00 - 300.00 mH)

PM motor Auto-Tuning automatically sets this parameter to the value of [PM Motor d-Axis Inductance].

**Note:**

Do not change the setting calculated by Auto-Tuning unless it is necessary.

### ■ E5-07: PM q-axis Inductance (mH/phase)

No. (Hex.)	Name	Description	Default (Range)
E5-07 (032F)	PM q-axis Inductance (mH/phase)	<input type="checkbox"/> V/f <input type="checkbox"/> CL-V/f <input type="checkbox"/> OLV <input type="checkbox"/> CLV <input type="checkbox"/> AOLV <input checked="" type="checkbox"/> OLV/PM <input type="checkbox"/> AOLV/PM <input type="checkbox"/> CLV/PM <input type="checkbox"/> EZOLV Sets the PM motor q-axis inductance.	Determined by E5-01 (0.00 - 600.00 mH)

PM motor Auto-Tuning automatically sets this parameter to the value of [PM Motor q-Axis Inductance].

**Note:**

Do not change the setting calculated by Auto-Tuning unless it is necessary.

### ■ E5-09: PM Back-EMF Vpeak (mV/(rad/s))

No. (Hex.)	Name	Description	Default (Range)
E5-09 (0331)	PM Back-EMF Vpeak (mV/(rad/s))	<input type="checkbox"/> V/f <input type="checkbox"/> CL-V/f <input type="checkbox"/> OLV <input type="checkbox"/> CLV <input type="checkbox"/> AOLV <input checked="" type="checkbox"/> OLV/PM <input type="checkbox"/> AOLV/PM <input type="checkbox"/> CLV/PM <input type="checkbox"/> EZOLV Sets the peak value of PM motor induced voltage.	Determined by E5-01 (0.0 - 2000.0 mV/(rad/s))

Set this parameter when you use an IPM motor with derated torque (SSR1-series) or an IPM motor with constant torque (SST4-series).

PM motor Auto-Tuning automatically sets this parameter to the value of [Back-EMF Voltage Constant (Ke)].

When *E5-01* = FFFF, only set *E5-09* or *E5-24* [PM Back-EMF L-L Vrms (mV/rpm)] as the induced voltage constant.

**Note:**

When you set this parameter, also set *E5-24* = 0.0. The drive will detect *oPE08* [Parameter Selection Error] in these conditions:

- *E5-09* = 0.0 and *E5-24* = 0.0
- *E5-09* ≠ 0.0 and *E5-24* ≠ 0.0

### ■ E5-11: Encoder Z-Pulse Offset

No. (Hex.)	Name	Description	Default (Range)
E5-11 (0333)	Encoder Z-Pulse Offset	<input type="checkbox"/> V/f <input type="checkbox"/> CL-V/f <input type="checkbox"/> OLV <input type="checkbox"/> CLV <input type="checkbox"/> AOLV <input type="checkbox"/> OLV/PM <input type="checkbox"/> AOLV/PM <input checked="" type="checkbox"/> CLV/PM <input type="checkbox"/> EZOLV Sets the encoder Z-pulse offset.	0.0 degrees (-180.0 - +180.0 degrees)

The drive uses the PM motor parameter settings and PM Stationary Auto-Tuning to set *E5-11* to the value input for “Encoder Z-Pulse Offset” automatically. The drive uses Z Pulse Offset Tuning or the Rotational Auto-Tuning to set *E5-11*.

### ■ E5-24: PM Back-EMF L-L Vrms (mV/rpm)

No. (Hex.)	Name	Description	Default (Range)
E5-24 (0353)	PM Back-EMF L-L Vrms (mV/rpm)	<input type="checkbox"/> V/f <input type="checkbox"/> CL-V/f <input type="checkbox"/> OLV <input type="checkbox"/> CLV <input type="checkbox"/> AOLV <input checked="" type="checkbox"/> OLV/PM <input type="checkbox"/> AOLV/PM <input type="checkbox"/> CLV/PM <input type="checkbox"/> EZOLV Sets the RMS value for PM motor line voltage.	Determined by E5-01 (0.0 - 6500.0 mV/min <sup>-1</sup> )

Set this parameter when you use an SPM motor (SMRA-Series Pico motor).

PM motor Auto-Tuning automatically sets this parameter to the value of [Back-EMF Voltage Constant (Ke)].

When *E5-01* = FFFF, only set *E5-09* [PM Back-EMF Vpeak (mV/(rad/s))] or *E5-24* as the induced voltage constant.

**Note:**

When you set this parameter, also set *E5-09* = 0.0. The drive will detect *oPE08* [Parameter Selection Error] in these conditions:

- *E5-09* = 0.0 and *E5-24* = 0.0
- *E5-09* ≠ 0.0 and *E5-24* ≠ 0.0



### ■ E5-25: Polarity Estimation Timeout

No. (Hex.)	Name	Description	Default (Range)
E5-25 (035E) Expert	Polarity Estimation Timeout	<div style="display: flex; justify-content: space-between; font-size: 0.8em; font-weight: normal;"> <span>V/f</span> <span>CL-V/f</span> <span>OLV</span> <span>CLV</span> <span>AOLV</span> <span style="background-color: #ccc;">OLV/PM</span> <span style="background-color: #ccc;">AOLV/PM</span> <span style="background-color: #ccc;">CLV/PM</span> <span style="background-color: #ccc;">EZOLV</span> </div> Sets the function that switches polarity for initial polarity estimation. Usually it is not necessary to change this setting.	0 (0, 1)

When “Sd = 1” is shown on the motor nameplate or test report for Yaskawa motors, set this parameter to 1.

**0 : Disabled**

**1 : Enabled**

## ◆ E9: Motor Setting

*E9 parameters* are used to configure induction motors, PM motors, and SynRM motors. Configure these parameters only for derating torque applications in which a high level of responsiveness and accurate speed control are not required.

*E9 parameters* are automatically configured with values input by the Auto-Tuning process for motor parameter settings. *E9 parameters* can be manually configured when the EZ Tuning process cannot be performed.

### ■ E9-01: Motor Type Selection

No. (Hex.)	Name	Description	Default (Range)
E9-01 (11E4)	Motor Type Selection	<div style="display: flex; justify-content: space-between; font-size: 0.8em; font-weight: normal;"> <span>V/f</span> <span>CL-V/f</span> <span>OLV</span> <span>CLV</span> <span>AOLV</span> <span>OLV/PM</span> <span>AOLV/PM</span> <span>CLV/PM</span> <span style="background-color: #ccc;">EZOLV</span> </div> Sets the type of motor.	0 (0 - 2)

EZ Tuning automatically sets this parameter to the value of [Motor Type Selection].

**0 : Induction (IM)**

**1 : Permanent Magnet (PM)**

**2 : Synchronous Reluctance (SynRM)**

### ■ E9-02: Maximum Speed

No. (Hex.)	Name	Description	Default (Range)
E9-02 (11E5)	Maximum Speed	<div style="display: flex; justify-content: space-between; font-size: 0.8em; font-weight: normal;"> <span>V/f</span> <span>CL-V/f</span> <span>OLV</span> <span>CLV</span> <span>AOLV</span> <span>OLV/PM</span> <span>AOLV/PM</span> <span>CLV/PM</span> <span style="background-color: #ccc;">EZOLV</span> </div> Sets the maximum speed of the motor.	Determined by E9-01 (40.0 - 120.0 Hz)

**Note:**

The unit of measure changes when the setting of *o1-04 [V/f Pattern Display Unit]*.

EZ Tuning automatically sets this parameter to the value of [Motor Max Revolutions].

### ■ E9-03: Rated Speed

No. (Hex.)	Name	Description	Default (Range)
E9-03 (11E6)	Rated Speed	<div style="display: flex; justify-content: space-between; font-size: 0.8em; font-weight: normal;"> <span>V/f</span> <span>CL-V/f</span> <span>OLV</span> <span>CLV</span> <span>AOLV</span> <span>OLV/PM</span> <span>AOLV/PM</span> <span>CLV/PM</span> <span style="background-color: #ccc;">EZOLV</span> </div> Sets the rated rotation speed of the motor.	Determined by E9-01 (100 - 7200 min <sup>-1</sup> )

EZ Tuning automatically sets this parameter to the value of [Rated Speed].

**Note:**

Set *E9-01 = 0 [Motor Type Selection = Induction (IM)]* before you set this parameter.

### ■ E9-04: Base Frequency

No. (Hex.)	Name	Description	Default (Range)
E9-04 (11E7)	Base Frequency	<div style="display: flex; justify-content: space-between; font-size: 0.8em; font-weight: normal;"> <span>V/f</span> <span>CL-V/f</span> <span>OLV</span> <span>CLV</span> <span>AOLV</span> <span>OLV/PM</span> <span>AOLV/PM</span> <span>CLV/PM</span> <span style="background-color: #ccc;">EZOLV</span> </div> Sets the rated frequency of the motor.	Determined by E9-01 (40.0 - 120.0 Hz)

## 11.6 E: Motor Parameters

**Note:**

The unit of measure changes when the setting of *o1-04* [*V/f Pattern Display Unit*].

EZ Tuning automatically sets this parameter to the value of [Base Frequency].

### ■ E9-05: Base Voltage

No. (Hex.)	Name	Description	Default (Range)
E9-05 (11E8)	Base Voltage	<div style="display: flex; justify-content: space-between; font-size: 0.8em; margin-bottom: 5px;"> <span>V/f</span> <span>CL-V/f</span> <span>OLV</span> <span>CLV</span> <span>AOLV</span> <span>OLV/PM</span> <span>AOLV/PM</span> <span>CLV/PM</span> <span style="background-color: #ccc; border: 1px solid #000; padding: 2px;">EZOLV</span> </div> Sets the rated voltage of the motor.	Determined by E9-01 (200 V Class: 0.0 to 255.0 V, 400 V Class: 0.0 to 510.0 V)

EZ Tuning automatically sets this parameter to the value of [Base Voltage].

### ■ E9-06: Motor Rated Current (FLA)

No. (Hex.)	Name	Description	Default (Range)
E9-06 (11E9)	Motor Rated Current (FLA)	<div style="display: flex; justify-content: space-between; font-size: 0.8em; margin-bottom: 5px;"> <span>V/f</span> <span>CL-V/f</span> <span>OLV</span> <span>CLV</span> <span>AOLV</span> <span>OLV/PM</span> <span>AOLV/PM</span> <span>CLV/PM</span> <span style="background-color: #ccc; border: 1px solid #000; padding: 2px;">EZOLV</span> </div> Sets the motor rated current in amps.	Determined by E9-01 and o2-04 (10% to 200% of the drive rated current)

**Note:**

When the drive model changes, the display units for this parameter also change.

- 0.01 A: 2004 to 2042, 4002 to 4023
- 0.1 A: 2056 to 2415, 4031 to 4675

The setting value of *E9-06* is the reference value for motor protection. Enter the motor rated current shown on the motor nameplate. Auto-Tuning the drive will automatically set *E9-06* to the value input for “Motor Rated Current”.

### ■ E9-07: Motor Rated Power (kW)

No. (Hex.)	Name	Description	Default (Range)
E9-07 (11EA)	Motor Rated Power (kW)	<div style="display: flex; justify-content: space-between; font-size: 0.8em; margin-bottom: 5px;"> <span>V/f</span> <span>CL-V/f</span> <span>OLV</span> <span>CLV</span> <span>AOLV</span> <span>OLV/PM</span> <span>AOLV/PM</span> <span>CLV/PM</span> <span style="background-color: #ccc; border: 1px solid #000; padding: 2px;">EZOLV</span> </div> Sets the motor rated power in 0.01 kW increments (1 HP = 0.746 kW).	Determined by E9-02 and o2-04 (0.00 - 650.00 kW)

Auto-Tuning automatically sets this parameter to the value of [Motor Rated Power (kW)].

**Note:**

When the maximum applicable motor output larger than 300 kW, the parameter value is in 0.1 kW units.

### ■ E9-08: Motor Pole Count

No. (Hex.)	Name	Description	Default (Range)
E9-08 (11EB)	Motor Pole Count	<div style="display: flex; justify-content: space-between; font-size: 0.8em; margin-bottom: 5px;"> <span>V/f</span> <span>CL-V/f</span> <span>OLV</span> <span>CLV</span> <span>AOLV</span> <span>OLV/PM</span> <span>AOLV/PM</span> <span>CLV/PM</span> <span style="background-color: #ccc; border: 1px solid #000; padding: 2px;">EZOLV</span> </div> Sets the number of motor poles.	4 (2 - 120)

Auto-Tuning automatically sets this parameter to the value of [Number of Motor Poles].

### ■ E9-09: Motor Rated Slip

No. (Hex.)	Name	Description	Default (Range)
E9-09 (11EC)	Motor Rated Slip	<div style="display: flex; justify-content: space-between; font-size: 0.8em; margin-bottom: 5px;"> <span>V/f</span> <span>CL-V/f</span> <span>OLV</span> <span>CLV</span> <span>AOLV</span> <span>OLV/PM</span> <span>AOLV/PM</span> <span>CLV/PM</span> <span style="background-color: #ccc; border: 1px solid #000; padding: 2px;">EZOLV</span> </div> Sets the motor rated slip.	0.0 Hz (0.0 - 20.0 Hz)

The setting value of this parameter is the slip compensation reference value.

The drive uses the setting values of *E9-03*, *E9-04*, and *E9-08* to calculate this parameter. When Motor Rated Slip = 0, Auto-Tuning automatically sets this parameter to the value of [Motor Rated Slip].

**Note:**

Set  $E9-01 = 0$  [Motor Type Selection = Induction (IM)] before you set this parameter.

### ■ E9-10: Motor Line-to-Line Resistance

No. (Hex.)	Name	Description	Default (Range)
E9-10 (11ED)	Motor Line-to-Line Resistance	<div style="display: flex; gap: 5px;"> <span>V/f</span> <span>CL-V/f</span> <span>OLV</span> <span>CLV</span> <span>AOLV</span> <span>OLV/PM</span> <span>AOLV/PM</span> <span>CLV/PM</span> <span style="background-color: #333; color: white; padding: 2px;">EZOLV</span> </div> Sets the line-to-line resistance for the motor stator windings.	Determined by o2-04 (0.000 - 65.000 Ω)

**Note:**

This value is the motor line-to-line resistance. Do not set this parameter with the single-phase resistance.

Stationary Auto-Tuning automatically sets this parameter. If you cannot do Stationary Auto-Tuning, use the test report from the motor manufacturer. You can calculate the motor line-to-line resistance with one of these formulas:

- E-type insulation: [the resistance value (Ω) shown on the test report at 75 °C] × 0.92
- B-type insulation: [the resistance value (Ω) shown on the test report at 75 °C] × 0.92
- F-type insulation: [the resistance value (Ω) shown on the test report at 115 °C] × 0.87

## 11.7 F: Options

*F* parameters are used to set option cards, which function as interfaces for encoders, analog I/O, digital I/O, and fieldbus communication.

### ◆ F1: Encoder Option Setup

*F1* parameters are used to set the operation of and protective function for the encoder option card. The following table lists the setting parameters available for each option card.

Refer to the instruction manual packaged with the encoder option card for more information on installing, wiring, and setting the encoder option cards.

**WARNING!** *Sudden Movement Hazard. Do test runs and examine the drive to make sure that command references are configured correctly. If you set the command reference incorrectly, it can cause death, serious injury, or equipment damage from unwanted motor rotation.*

**WARNING!** *Sudden Movement Hazard. Conduct proper host controller safety design to prevent motors from running uncontrolled when there is a loss of speed feedback. The motor has a potential to run uncontrolled.*

Table 11.49 Encoder Option Card Setting Parameters

Setting Parameter	Encoder Option Card			
	PG-B3	PG-X3	PG-F3	PG-RT3
F1-01	x	x	x	-
F1-02	x	x	x	x
F1-03	x	x	x	x
F1-04	x	x	x	x
F1-05	x	x	x	x
F1-06	x	x	x	-
F1-08	x	x	x	x
F1-09	x	x	x	x
F1-10	x	x	x	x
F1-11	x	x	x	x
F1-12 *1	x	x	-	-
F1-13 *1	x	x	-	-
F1-14	x	x	x	x
F1-18	x	x	x	x
F1-19	x	x	x	x
F1-20	-	x	x	-
F1-21	x	x	-	-
F1-30	x	x	-	-
F1-31 *2	x	x	-	-
F1-32 *2	x	x	-	-
F1-33 *1 *2	x	x	-	-
F1-34 *1 *2	x	x	-	-
F1-35 *2	x	x	-	-
F1-36	-	x	-	-
F1-37 *2	x	x	-	-
F1-50	-	-	x	-
F1-51	-	-	x	-
F1-52	-	-	x	-
Number of cards that can be installed in a drive	2	2	1	1

\*1 Parameters set when using the Closed Loop V/f Control method.

\*2 Parameters to set an option card connected to CN5-B.

### ■ F1-01: Encoder 1 Pulse Count (PPR)

No. (Hex.)	Name	Description	Default (Range)
F1-01 (0380)	Encoder 1 Pulse Count (PPR)	<input type="checkbox"/> V/f <input checked="" type="checkbox"/> CL-V/f <input type="checkbox"/> OLV <input checked="" type="checkbox"/> CLV <input type="checkbox"/> AOLV <input type="checkbox"/> OLV/PM <input type="checkbox"/> AOLV/PM <input checked="" type="checkbox"/> CLV/PM <input type="checkbox"/> EZOLV Sets the number of output pulses for each motor revolution.	1024 ppr (1 - 60000 ppr)

### ■ F1-02: Encoder Signal Loss Detect Sel

No. (Hex.)	Name	Description	Default (Range)
F1-02 (0381)	Encoder Signal Loss Detect Sel	<input type="checkbox"/> V/f <input checked="" type="checkbox"/> CL-V/f <input type="checkbox"/> OLV <input checked="" type="checkbox"/> CLV <input type="checkbox"/> AOLV <input type="checkbox"/> OLV/PM <input type="checkbox"/> AOLV/PM <input checked="" type="checkbox"/> CLV/PM <input type="checkbox"/> EZOLV Sets the method to stop the motor or let the motor continue operating when the drive detects a PGo [Encoder (PG) Feedback Loss].	1 (0 - 4)

When the drive does not detect output pulses from the encoder for the time set in F1-14 [Encoder Open-Circuit Detect Time], it will trigger PGo.

**Note:**

- Motor speed and load conditions can cause ov [Overvoltage] and oC [Overcurrent] faults.
- In AOLV control, set  $n4-72 = 1$  [Speed Feedback Mode = With Encoder].

#### 0 : Ramp to Stop

The drive ramps to stop in the set deceleration time. Fault relay output terminal MA-MC activates and terminal MB-MC deactivates.

#### 1 : Coast to Stop

The drive output shuts off and the motor coasts to stop. Fault relay output terminal MA-MC activates and terminal MB-MC deactivates.

#### 2 : Fast Stop (Use C1-09)

The drive stops the motor in the deceleration time set in C1-09 [Fast Stop Time]. Fault relay output terminal MA-MC activates and terminal MB-MC deactivates.

#### 3 : Alarm Only

The keypad shows PGo and the drive continues operation. Only use this setting in special conditions to prevent damage to the motor and machinery. The output terminal set for Alarm [H2-01 to H2-03 = 10] activates.

#### 4 : No Alarm Display

The drive continues operation and does not show PGo on the keypad. Only use this setting in special conditions to prevent damage to the motor and machinery.

### ■ F1-03: Overspeed Detection Selection

No. (Hex.)	Name	Description	Default (Range)
F1-03 (0382)	Overspeed Detection Selection	<input type="checkbox"/> V/f <input checked="" type="checkbox"/> CL-V/f <input type="checkbox"/> OLV <input checked="" type="checkbox"/> CLV <input type="checkbox"/> AOLV <input type="checkbox"/> OLV/PM <input type="checkbox"/> AOLV/PM <input checked="" type="checkbox"/> CLV/PM <input type="checkbox"/> EZOLV Sets the method to stop the motor or let the motor continue operating when the drive detects a oS [Overspeed].	1 (0 - 3)

When the motor speed is more than the value set in F1-08 [Overspeed Detection Level] for longer than the time set in F1-09 [Overspeed Detection Delay Time] trigger oS.

#### 0 : Ramp to Stop

The drive ramps to stop in the set deceleration time. Fault relay output terminal MA-MC activates and terminal MB-MC deactivates.

#### 1 : Coast to Stop

The drive output shuts off and the motor coasts to stop. Fault relay output terminal MA-MC activates and terminal MB-MC deactivates.

#### 2 : Fast Stop (Use C1-09)

The drive stops the motor in the deceleration time set in C1-09 [Fast Stop Time]. Fault relay output terminal MA-MC activates and terminal MB-MC deactivates.

**3 : Alarm Only**

The keypad shows *oS* and the drive continues operation. Only use this setting in special conditions to prevent damage to the motor and machinery. The output terminal set for *Alarm [H2-01 to H2-03 = 10]* activates.

**4 : No Alarm Display**

The drive continues operation and does not show *oS* on the keypad. Only use this setting in special conditions to prevent damage to the motor and machinery.

**Note:**

When *A1-02 = 6 [Control Method Selection = PM Advanced Open Loop Vector]*, the drive will automatically set *F1-03 = 1 [Coast to Stop]*. You cannot change this value.

■ **F1-04: Speed Deviation Detection Select**

No. (Hex.)	Name	Description	Default (Range)
F1-04 (0383)	Speed Deviation Detection Select	<div style="display: flex; justify-content: space-between; font-size: small;"> <span>V/f</span> <span>CL-V/f</span> <span>OLV</span> <span>CLV</span> <span>AOLV</span> <span>OLV/PM</span> <span>AOLV/PM</span> <span>CLV/PM</span> <span>EZOLV</span> </div> <p>Sets the method to stop the motor or let the motor continue operating when the drive detects a <i>dEv [Speed Deviation]</i>.</p>	3 (0 - 3)

When the difference between the frequency reference and the motor speed is more than the value set in *F1-10 [Speed Deviation Detection Level]* for longer than the time set in *F1-11 [Speed Deviation Detect DelayTime]*, it will trigger *dEv*.

**0 : Ramp to Stop**

The drive ramps to stop in the set deceleration time. Fault relay output terminal MA-MC activates and terminal MB-MC deactivates.

**1 : Coast to Stop**

The drive output shuts off and the motor coasts to stop. Fault relay output terminal MA-MC activates and terminal MB-MC deactivates.

**2 : Fast Stop (Use C1-09)**

The drive stops the motor in the deceleration time set in *C1-09 [Fast Stop Time]*. Fault relay output terminal MA-MC activates and terminal MB-MC deactivates.

**3 : Alarm Only**

The keypad shows *dEv* and the drive continues operation. Only use this setting in special conditions to prevent damage to the motor and machinery. The output terminal set for *Alarm [H2-01 to H2-03 = 10]* activates.

■ **F1-05: Encoder 1 Rotation Selection**

No. (Hex.)	Name	Description	Default (Range)
F1-05 (0384)	Encoder 1 Rotation Selection	<div style="display: flex; justify-content: space-between; font-size: small;"> <span>V/f</span> <span>CL-V/f</span> <span>OLV</span> <span>CLV</span> <span>AOLV</span> <span>OLV/PM</span> <span>AOLV/PM</span> <span>CLV/PM</span> <span>EZOLV</span> </div> <p>Sets the output sequence for the A and B pulses from the encoder, assuming that the motor is operating in the forward direction.</p>	Determined by A1-02 (0, 1)

Refer to the option card installation manual for more information about how to set the encoder pulse output sequence and make sure that it is correct.

**0 : Pulse A leads in FWD Direction**

**1 : Pulse B leads in FWD Direction**

■ **F1-06: Encoder 1 Pulse Monitor Scaling**

No. (Hex.)	Name	Description	Default (Range)
F1-06 (0385)	Encoder 1 Pulse Monitor Scaling	<div style="display: flex; justify-content: space-between; font-size: small;"> <span>V/f</span> <span>CL-V/f</span> <span>OLV</span> <span>CLV</span> <span>AOLV</span> <span>OLV/PM</span> <span>AOLV/PM</span> <span>CLV/PM</span> <span>EZOLV</span> </div> <p>Sets the ratio between the pulse input and the pulse output of the encoder as a 3-digit number. The first digit is the numerator and the second and third digits set the denominator.</p>	001 (001 - 032, 102 - 132 (1 - 1/32))

When the setting value is a 3-digit value (*xyz*), the dividing ratio is  $(1 + x)/yz$

For example, when *F1-06 = 032*, the dividing ratio is  $1/32$ .

**Note:**

When you use a single-pulse encoder, the dividing ratio for the monitor signal is 1:1

### ■ F1-08: Overspeed Detection Level

No. (Hex.)	Name	Description	Default (Range)
F1-08 (0387)	Overspeed Detection Level	<input type="checkbox"/> V/f <input checked="" type="checkbox"/> CL-V/f <input type="checkbox"/> OLV <input checked="" type="checkbox"/> CLV <input type="checkbox"/> AOLV <input type="checkbox"/> OLV/PM <input type="checkbox"/> AOLV/PM <input type="checkbox"/> CLV/PM <input type="checkbox"/> EZOLV Sets the detection level of <i>oS</i> [Overspeed] as a percentage when the maximum output frequency is 100%.	115% (0 - 120%)

When the motor speed is more than the value set in *F1-08* for longer than the time set in *F1-09* [Overspeed Detection Delay Time], the drive will detect *oS*.

### ■ F1-09: Overspeed Detection Delay Time

No. (Hex.)	Name	Description	Default (Range)
F1-09 (0388)	Overspeed Detection Delay Time	<input type="checkbox"/> V/f <input checked="" type="checkbox"/> CL-V/f <input type="checkbox"/> OLV <input checked="" type="checkbox"/> CLV <input type="checkbox"/> AOLV <input type="checkbox"/> OLV/PM <input type="checkbox"/> AOLV/PM <input type="checkbox"/> CLV/PM <input type="checkbox"/> EZOLV Sets the length of time that the speed feedback must be more than the <i>F1-08</i> level to cause an <i>oS</i> [Overspeed].	Determined by A1-02 (0.0 - 2.0 s)

When the motor speed is more than the value set in *F1-08* [Overspeed Detection Level] for longer than the time set in *F1-09*, the drive will detect *oS*.

### ■ F1-10: Speed Deviation Detection Level

No. (Hex.)	Name	Description	Default (Range)
F1-10 (0389)	Speed Deviation Detection Level	<input type="checkbox"/> V/f <input checked="" type="checkbox"/> CL-V/f <input type="checkbox"/> OLV <input checked="" type="checkbox"/> CLV <input type="checkbox"/> AOLV <input type="checkbox"/> OLV/PM <input type="checkbox"/> AOLV/PM <input type="checkbox"/> CLV/PM <input type="checkbox"/> EZOLV Sets the detection level of <i>dEv</i> [Speed Deviation] as a percentage when the maximum output frequency is 100%.	10% (0 - 50%)

When the speed deviation between the frequency reference and the actual motor speed is more than the value set in *F1-10* for longer than the time set in *F1-11* [Speed Deviation Detect DelayTime], the drive will detect *dEv*.

### ■ F1-11: Speed Deviation Detect DelayTime

No. (Hex.)	Name	Description	Default (Range)
F1-11 (038A)	Speed Deviation Detect DelayTime	<input type="checkbox"/> V/f <input checked="" type="checkbox"/> CL-V/f <input type="checkbox"/> OLV <input checked="" type="checkbox"/> CLV <input type="checkbox"/> AOLV <input type="checkbox"/> OLV/PM <input type="checkbox"/> AOLV/PM <input type="checkbox"/> CLV/PM <input type="checkbox"/> EZOLV Sets the length of time that the difference between the frequency reference and speed feedback must be more than the level in <i>F1-10</i> to cause a <i>dEv</i> [Speed Deviation].	0.5 s (0.0 - 10.0 s)

When the speed deviation between the frequency reference and the actual motor speed is more than the value set in *F1-10* [Speed Deviation Detection Level] for longer than the time set in *F1-11*, the drive will detect *dEv*.

### ■ F1-12: Encoder 1 Gear Teeth 1

No. (Hex.)	Name	Description	Default (Range)
F1-12 (038B)	Encoder 1 Gear Teeth 1	<input type="checkbox"/> V/f <input checked="" type="checkbox"/> CL-V/f <input type="checkbox"/> OLV <input type="checkbox"/> CLV <input type="checkbox"/> AOLV <input type="checkbox"/> OLV/PM <input type="checkbox"/> AOLV/PM <input type="checkbox"/> CLV/PM <input type="checkbox"/> EZOLV Sets the number of gear teeth on the motor side. This parameter and <i>F1-13</i> [Encoder 1 Gear Teeth 2] set the gear ratio between the motor and encoder.	0 (0 - 1000)

After you set the number of gear teeth, the drive uses this formula to calculate the motor speed:

$$\text{Motor speed (min}^{-1}\text{ or r/min)} = \frac{\text{Number of pulses from the encoder} \times 60}{F1-01} \times \frac{F1-13}{F1-12}$$

**Note:**

When *F1-12* = 0 or *F1-13* = 0, the gear ratio is 1.

■ **F1-13: Encoder 1 Gear Teeth 2**

No. (Hex.)	Name	Description	Default (Range)
F1-13 (038C)	Encoder 1 Gear Teeth 2	<div style="display: flex; justify-content: space-between; font-size: small;"> <span>V/f</span> <span>CL-V/f</span> <span>OLV</span> <span>CLV</span> <span>AOLV</span> <span>OLV/PM</span> <span>AOLV/PM</span> <span>CLV/PM</span> <span>EZOLV</span> </div> <p>Sets the number of gear teeth on the load side. This parameter and <i>F1-12 [Encoder 1 Gear Teeth 1]</i> set the gear ratio between the motor and encoder.</p>	0 (0 - 1000)

After you set the number of gear teeth, the drive uses this formula to calculate the motor speed:

$$\text{Motor speed (min}^{-1} \text{ or r/min)} = \frac{\text{Number of pulses from the encoder} \times 60}{F1-01} \times \frac{F1-13}{F1-12}$$

**Note:**

When *F1-12 = 0* or *F1-13 = 0*, the gear ratio is 1.

■ **F1-14: Encoder Open-Circuit Detect Time**

No. (Hex.)	Name	Description	Default (Range)
F1-14 (038D)	Encoder Open-Circuit Detect Time	<div style="display: flex; justify-content: space-between; font-size: small;"> <span>V/f</span> <span>CL-V/f</span> <span>OLV</span> <span>CLV</span> <span>AOLV</span> <span>OLV/PM</span> <span>AOLV/PM</span> <span>CLV/PM</span> <span>EZOLV</span> </div> <p>Sets the length of time that the drive must not receive a pulse signal to cause a <i>PGo [Encoder (PG) Feedback Loss]</i>.</p>	2.0 s (0.0 - 10.0 s)

If the drive does not detect output pulses from the encoder for longer than the time set in *F1-14*, the drive will detect *PGo*.

**Note:**

Motor speed and load conditions can cause *ov [Overvoltage]* and *oC [Overcurrent]* faults.

■ **F1-18: Deviation 3 Detection Selection**

No. (Hex.)	Name	Description	Default (Range)
F1-18 (03AD)	Deviation 3 Detection Selection	<div style="display: flex; justify-content: space-between; font-size: small;"> <span>V/f</span> <span>CL-V/f</span> <span>OLV</span> <span>CLV</span> <span>AOLV</span> <span>OLV/PM</span> <span>AOLV/PM</span> <span>CLV/PM</span> <span>EZOLV</span> </div> <p>Sets the number of rotations necessary to detect conditions that invert the torque reference and rate of acceleration and cause <i>dv3 [Inversion Detection]</i>.</p>	10 (0 - 10)

When the drive detects these two conditions at the same time for the number of times set in *F1-18*, the drive will detect *dv3*.

- The torque reference and acceleration are in opposite directions. For example, torque reference is in forward run and the acceleration is in a negative direction.
- The difference between the speed reference and the actual motor speed is more than 30%.

**Note:**

- Reference the setting value for *E5-11 [Encoder Z-Pulse Offset]* and the  $\delta\theta$  value found on the motor nameplate. A usual cause for a *dv3* fault is an incorrect *E5-11* setting.
- Set *F1-18 = 0* to disable the function.

■ **F1-19: Deviation 4 Detection Selection**

No. (Hex.)	Name	Description	Default (Range)
F1-19 (03AE)	Deviation 4 Detection Selection	<div style="display: flex; justify-content: space-between; font-size: small;"> <span>V/f</span> <span>CL-V/f</span> <span>OLV</span> <span>CLV</span> <span>AOLV</span> <span>OLV/PM</span> <span>AOLV/PM</span> <span>CLV/PM</span> <span>EZOLV</span> </div> <p>Sets the number of pulses necessary to cause <i>dv4 [Inversion Prevention Detection]</i>.</p>	128 (0 - 5000)

The drive detects a *dv4 [Inversion Prevention Detection]* fault when the pulses in a reverse direction to the speed reference are input for longer than the time set in *F1-19*.

**Note:**

- Refer to the *E5-11 [Encoder Z-Pulse Offset]* value and the  $\Delta\theta$  value shown on the motor nameplate. An incorrect *E5-11* value will frequently be the cause of a *dv4* fault.
- When you use the drive in an application that rotates the motor from the load side in the reverse direction of the speed reference, set *F1-19 = 0*.



### ■ F1-20: Encoder 1 PCB Disconnect Detect

No. (Hex.)	Name	Description	Default (Range)
F1-20 (03B4)	Encoder 1 PCB Disconnect Detect	<input type="checkbox"/> V/f <input checked="" type="checkbox"/> CL-V/f <input type="checkbox"/> OLV <input checked="" type="checkbox"/> CLV <input type="checkbox"/> AOLV <input type="checkbox"/> OLV/PM <input type="checkbox"/> AOLV/PM <input type="checkbox"/> CLV/PM <input type="checkbox"/> EZOLV Sets the function that enables and disables detection of a disconnected encoder connection cable to cause PGoH [Encoder (PG) Hardware Fault].	1 (0, 1)

0 : Disabled

1 : Enabled

### ■ F1-21: Encoder 1 Signal Selection

No. (Hex.)	Name	Description	Default (Range)
F1-21 (03BC)	Encoder 1 Signal Selection	<input type="checkbox"/> V/f <input checked="" type="checkbox"/> CL-V/f <input type="checkbox"/> OLV <input type="checkbox"/> CLV <input type="checkbox"/> AOLV <input type="checkbox"/> OLV/PM <input type="checkbox"/> AOLV/PM <input type="checkbox"/> CLV/PM <input type="checkbox"/> EZOLV Sets the number of channels for the signal to the encoder option card.	0 (0, 1)

0 : A Pulse Detection

1 : AB Pulse Detection

### ■ F1-30: Motor 2 Encoder PCB Port Select

No. (Hex.)	Name	Description	Default (Range)
F1-30 (03AA)	Motor 2 Encoder PCB Port Select	<input type="checkbox"/> V/f <input checked="" type="checkbox"/> CL-V/f <input type="checkbox"/> OLV <input checked="" type="checkbox"/> CLV <input type="checkbox"/> AOLV <input type="checkbox"/> OLV/PM <input type="checkbox"/> AOLV/PM <input type="checkbox"/> CLV/PM <input type="checkbox"/> EZOLV Sets the drive port to install the motor 2 encoder option card.	1 (0, 1)

0 : CN5-C

One option card receives the speed feedback signals from motor 1 and motor 2.

1 : CN5-B

Two option cards receive the speed feedback signals from motor 1 and motor 2.

### ■ F1-31: Encoder 2 Pulse Count (PPR)

No. (Hex.)	Name	Description	Default (Range)
F1-31 (03B0)	Encoder 2 Pulse Count (PPR)	<input type="checkbox"/> V/f <input checked="" type="checkbox"/> CL-V/f <input type="checkbox"/> OLV <input checked="" type="checkbox"/> CLV <input type="checkbox"/> AOLV <input type="checkbox"/> OLV/PM <input type="checkbox"/> AOLV/PM <input type="checkbox"/> CLV/PM <input type="checkbox"/> EZOLV Sets the number of output pulses for each motor revolution for motor 2.	1024 ppr (1 - 60000 ppr)

### ■ F1-32: Encoder 2 Rotation Selection

No. (Hex.)	Name	Description	Default (Range)
F1-32 (03B1)	Encoder 2 Rotation Selection	<input type="checkbox"/> V/f <input checked="" type="checkbox"/> CL-V/f <input type="checkbox"/> OLV <input checked="" type="checkbox"/> CLV <input type="checkbox"/> AOLV <input type="checkbox"/> OLV/PM <input type="checkbox"/> AOLV/PM <input type="checkbox"/> CLV/PM <input type="checkbox"/> EZOLV Sets the output sequence for the A and B pulses from the encoder for motor 2. This parameter assumes that the motor is operating in the forward direction.	0 (0, 1)

Refer to the option card installation manual for more information about how to set the encoder pulse output sequence and make sure that it is correct.

0 : Pulse A leads in FWD Direction

1 : Pulse B leads in FWD Direction

### ■ F1-33: Encoder 2 Gear Teeth 1

No. (Hex.)	Name	Description	Default (Range)
F1-33 (03B2)	Encoder 2 Gear Teeth 1	<input type="checkbox"/> V/f <input checked="" type="checkbox"/> CL-V/f <input type="checkbox"/> OLV <input type="checkbox"/> CLV <input type="checkbox"/> AOLV <input type="checkbox"/> OLV/PM <input type="checkbox"/> AOLV/PM <input type="checkbox"/> CLV/PM <input type="checkbox"/> EZOLV Sets the number of gear teeth on the motor side for motor 2. This parameter and F1-34 [Encoder 2 Gear Teeth 2] set the gear ratio between the motor and encoder.	0 (0 - 1000)

## 11.7 F: Options

After you set the number of gear teeth, the drive uses this formula to calculate the motor speed:

$$\text{Motor speed (min}^{-1} \text{ or r/min)} = \frac{\text{Number of pulses from the encoder} \times 60}{F1-31} \times \frac{F1-33}{F1-34}$$

**Note:**

When  $F1-33 = 0$  or  $F1-34 = 0$ , the gear ratio is 1.

### ■ F1-34: Encoder 2 Gear Teeth 2

No. (Hex.)	Name	Description	Default (Range)
F1-34 (03B3)	Encoder 2 Gear Teeth 2	<div style="display: flex; justify-content: space-between; font-size: small;"> <span>V/f</span> <span style="background-color: #cccccc;">CL-V/f</span> <span>OLV</span> <span>CLV</span> <span>AOLV</span> <span>OLV/PM</span> <span>AOLV/PM</span> <span>CLV/PM</span> <span>EZOLV</span> </div> <p>Sets the number of gear teeth on the load side for motor 2. This parameter and <math>F1-33</math> [<i>Encoder 2 Gear Teeth 1</i>] set the gear ratio between the motor and encoder.</p>	0 (0 - 1000)

After you set the number of gear teeth, the drive uses this formula to calculate the motor speed:

$$\text{Motor speed (min}^{-1} \text{ or r/min)} = \frac{\text{Number of pulses from the encoder} \times 60}{F1-31} \times \frac{F1-33 \text{ (load-side PG gear teeth)}}{F1-34 \text{ (motor-side PG gear teeth)}}$$

**Note:**

When  $F1-33 = 0$  or  $F1-34 = 0$ , the gear ratio is 1.

### ■ F1-35: Encoder 2 Pulse Monitor Scaling

No. (Hex.)	Name	Description	Default (Range)
F1-35 (03BE)	Encoder 2 Pulse Monitor Scaling	<div style="display: flex; justify-content: space-between; font-size: small;"> <span>V/f</span> <span style="background-color: #cccccc;">CL-V/f</span> <span>OLV</span> <span style="background-color: #cccccc;">CLV</span> <span>AOLV</span> <span>OLV/PM</span> <span>AOLV/PM</span> <span>CLV/PM</span> <span>EZOLV</span> </div> <p>Sets the ratio between the pulse input and the pulse output of the encoder as a 3-digit number for motor 2. The first digit is the numerator and the second and third digits set the denominator.</p>	001 (001 - 032, 102 - 132 (1 - 1/32))

When the setting value is a 3-digit value (xyz), the dividing ratio is  $(1 + x)/yz$ .

For example, when  $F1-35 = 032$ , the dividing ratio is  $1/32$ .

**Note:**

For a single-pulse encoder, the dividing ratio for the monitor signal is 1:1.

### ■ F1-36: Encoder 2 PCB Disconnect Detect

No. (Hex.)	Name	Description	Default (Range)
F1-36 (03B5)	Encoder 2 PCB Disconnect Detect	<div style="display: flex; justify-content: space-between; font-size: small;"> <span>V/f</span> <span style="background-color: #cccccc;">CL-V/f</span> <span>OLV</span> <span style="background-color: #cccccc;">CLV</span> <span>AOLV</span> <span>OLV/PM</span> <span>AOLV/PM</span> <span>CLV/PM</span> <span>EZOLV</span> </div> <p>Sets the function that enables and disables detection of a disconnected encoder connection cable to cause <i>PGoH</i> [<i>Encoder (PG) Hardware Fault</i>] for motor 2.</p>	1 (0, 1)

**0 : Disabled**

**1 : Enabled**

### ■ F1-37: Encoder 2 Signal Selection

No. (Hex.)	Name	Description	Default (Range)
F1-37 (03BD)	Encoder 2 Signal Selection	<div style="display: flex; justify-content: space-between; font-size: small;"> <span>V/f</span> <span style="background-color: #cccccc;">CL-V/f</span> <span>OLV</span> <span>CLV</span> <span>AOLV</span> <span>OLV/PM</span> <span>AOLV/PM</span> <span>CLV/PM</span> <span>EZOLV</span> </div> <p>Sets the number of channels for the signal to the encoder option card for motor 2.</p>	0 (0, 1)

**0 : A Pulse Detection**

**1 : AB Pulse Detection**

### ■ F1-50: PG-F3 Option Encoder Type

No. (Hex.)	Name	Description	Default (Range)
F1-50 (03D2)	PG-F3 Option Encoder Type	<span>V/f</span> <span>CL-V/f</span> <span>OLV</span> <span>CLV</span> <span>AOLV</span> <span>OLV/PM</span> <span>AOLV/PM</span> <span>CLV/PM</span> <span>EZOLV</span> Sets the type of encoder connected to the PG-F3 option.	0 (0 - 2)

0 : EnDat Sin/Cos

1 : EnDat Serial Only

2 : HIPERFACE

### ■ F1-51: PG-F3 PGoH Detection Level

No. (Hex.)	Name	Description	Default (Range)
F1-51 (03D3)	PG-F3 PGoH Detection Level	<span>V/f</span> <span>CL-V/f</span> <span>OLV</span> <span>CLV</span> <span>AOLV</span> <span>OLV/PM</span> <span>AOLV/PM</span> <span>CLV/PM</span> <span>EZOLV</span> The drive will detect <i>PGoH</i> [Encoder (PG) Hardware Fault] when the value of this parameter is less than the value of $\sqrt{\sin^2\theta + \cos^2\theta}$ .	80% (1 - 100%)

The drive will detect *PGoH* when the value of this parameter is less than the value of  $\sqrt{\sin^2\theta + \cos^2\theta}$ .

For expression  $\sqrt{\sin^2\theta + \cos^2\theta}$ , Sin  $\theta$  is the single-track (phase B) output from the encoder and Cos  $\theta$  is the single-track (phase A) output from the encoder.

Note:

This function is enabled when  $F1-20 = 1$  [Encoder 1 PCB Disconnect Detect = Enabled].

### ■ F1-52: Serial Encoder Comm Speed

No. (Hex.)	Name	Description	Default (Range)
F1-52 (03D4)	Serial Encoder Comm Speed	<span>V/f</span> <span>CL-V/f</span> <span>OLV</span> <span>CLV</span> <span>AOLV</span> <span>OLV/PM</span> <span>AOLV/PM</span> <span>CLV/PM</span> <span>EZOLV</span> Sets the communication speed between the PG-F3 option and the serial encoder.	0 (0 - 2)

Note:

Set  $F1-50 = 1$  or  $2$  [PG-F3 Option Encoder Type = EnDat Serial Only or HIPERFACE] to enable this function.

0 : 1M/9600bps

1 : 500k/19200bps

2 : 1M/38400bps

## ◆ F2: Analog Input Option

*F2 parameters* set the operation of the drive when you use analog input option card AI-A3. The AI-A3 card has 3 input terminals that accept voltages of -10 V to +10 V (20 k $\Omega$ ) or currents of 4 mA to 20 mA (250  $\Omega$ ). Install the AI-A3 card to enable setting very accurate analog references with high resolution.

Refer to the AI-A3 card manual for more information about how to install, wire, and set the AI-A3 card.

**WARNING!** Sudden Movement Hazard. Do test runs and examine the drive to make sure that command references are configured correctly. If you set the command reference incorrectly, it can cause death, serious injury, or equipment damage from unwanted motor rotation.

### ■ F2-01: Analog Input Function Selection

No. (Hex.)	Name	Description	Default (Range)
F2-01 (038F)	Analog Input Function Selection	<span>V/f</span> <span>CL-V/f</span> <span>OLV</span> <span>CLV</span> <span>AOLV</span> <span>OLV/PM</span> <span>AOLV/PM</span> <span>CLV/PM</span> <span>EZOLV</span> Sets the input method for the analog reference used with AI-A3.	0 (0, 1)

Note:

When the AI-A3 card is not mounted in the drive, analog input terminals A1 to A3 on the drive are always enabled. The setting of this parameter does not have an effect.

0 : 3 Independent Channels

Set  $F2-01 = 0$  to increase the precision of A/D conversion when you use the functions for terminals A1 to A3 on the drive as they are. You can input the MFAI signal from terminals V1 through V3 for AI-A3. The functions for terminals A1, A2, and A3 on the drive are sent to terminals V1, V2, and V3 for AI-A3. Use gain and bias adjustment when you input current to set signals to have negative numbers.

**Note:**

- Set  $b1-01 = 1$  [Frequency Reference Selection 1 = Analog Input] to set inputs individually.
- If  $F2-01 = 0$  and  $b1-01 = 3$  [Option PCB], the drive will detect  $oPE05$  [Run Cmd/Freq Ref Source Sel Err].

Figure 11.77 shows the individual input of analog inputs.  $H3-xx$  parameters set the function to input the analog reference received from the AI-A3 card and to adjust the gain and bias of these signals.

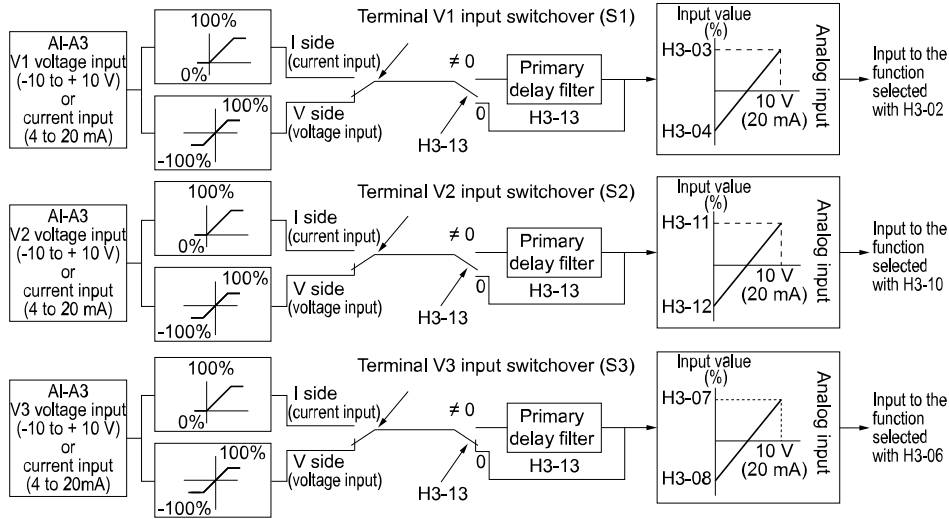


Figure 11.77 Analog Input Reference Individual Input Block Diagram

**1 : 3 Channels Added Together**

Set  $b1-01 = 3$  [Option PCB] to set addition input.

You can input the frequency reference directly. The sum value when you add the input from terminals V1 to V3 becomes the frequency reference.

Set  $F2-01 = 1$  to use the AI-A3 card as addition input.

Figure 11.78 shows addition input. Use  $F2-02$  [Analog Input Option Card Gain] and  $F2-03$  [Analog Input Option Card Bias] to adjust the analog reference gain and bias for addition input.

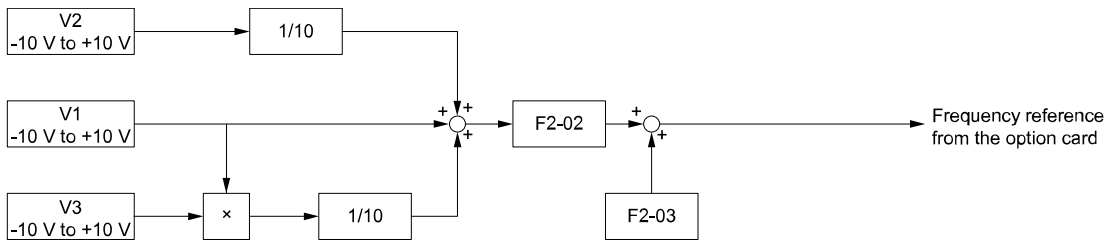


Figure 11.78 Analog Input Reference Addition Input Block Diagram

**Use F2-02 and F2-03 to Adjust the Input Status**

When the bias set in  $F2-03$  is 0%, the gain in  $F2-02$  and the addition input value set the ratio (%) of the maximum output frequency output as the frequency reference.

**Note:**

A voltage input of 10 V or a current input of 20 mA is the 100% value for each channel.

The bias set in  $F2-03$  sets the ratio (%) of the maximum output frequency output as the frequency reference when the addition input value is 0%.

**Note:**

A voltage input of 0 V or a current input of 4 mA is the 0% value for each channel.

- Example 1:  
When the gain set in  $F2-02$  is 50%, the bias set in  $F2-03$  is 0%, and the addition input value is 100%, the frequency reference is 50% of the maximum output frequency. When the addition input value is 200%, the frequency reference is 100% of the maximum output frequency.
- Example 2:

When the gain set in  $F2-02$  is 200%, the bias set in  $F2-03$  is 0%, and the addition input value is 50%, the frequency reference is equivalent to the maximum output frequency. The frequency reference will not be more than the maximum output frequency, although the addition input value is 50% or higher.

• Example 3:

When the gain set in  $F2-02$  is 100%, the bias set in  $F2-03$  is 30%, and the addition input value is 0%, the frequency reference is 30% of the maximum output frequency. When the addition input value is 70%, the frequency reference will be equivalent to the maximum output frequency. The frequency reference will not be more than the maximum output frequency, although the addition input value is 70% or higher.

### ■ F2-02: Analog Input Option Card Gain

No. (Hex.)	Name	Description	Default (Range)
F2-02 (0368) RUN	Analog Input Option Card Gain	<b>V/f</b> <b>CL-V/f</b> <b>OLV</b> <b>CLV</b> <b>AOLV</b> <b>OLV/PM</b> <b>AOLV/PM</b> <b>CLV/PM</b> <b>EZOLV</b> Sets the analog reference gain as a percentage when the maximum output frequency is 100%.	100.0% (-999.9 - +999.9%)

**Note:**

Set  $F2-01 = 1$  [*Analog Input Function Selection = 3 Channels Added Together*] to enable this function.

### ■ F2-03: Analog Input Option Card Bias

No. (Hex.)	Name	Description	Default (Range)
F2-03 (0369) RUN	Analog Input Option Card Bias	<b>V/f</b> <b>CL-V/f</b> <b>OLV</b> <b>CLV</b> <b>AOLV</b> <b>OLV/PM</b> <b>AOLV/PM</b> <b>CLV/PM</b> <b>EZOLV</b> Sets the analog reference bias as a percentage when the maximum output frequency is 100%.	0.0% (-999.9 - +999.9%)

**Note:**

Set  $F2-01 = 1$  [*Analog Input Function Selection = 3 Channels Added Together*] to enable this function.

## ◆ F3: Digital Input Option

$F3$  parameters set the type of input signal to use with digital input option card DI-A3.

Use these digital inputs to set the frequency reference when you install the DI-A3 card in a drive. Set  $b1-01 = 3$  [*Frequency Reference Selection 1 = Option PCB*] to use this card as the frequency reference input. The input signal is isolated input of 24 Vdc and 8 mA.

- Binary, 16-bit/BCD, 4-digit input
- Binary, 12-bit/BCD, 3-digit input
- Binary, 8-bit/BCD, 2-digit input

You can also use the DI-A3 card as an MFDI, if the setting of  $F3-01$  is correct.

**WARNING!** *Sudden Movement Hazard. Do test runs and examine the drive to make sure that command references are configured correctly. If you set the command reference incorrectly, it can cause death, serious injury, or equipment damage from unwanted motor rotation.*

### ■ MFDI for DI-A3

Set  $F3-01 = 8$  [*Digital Input Function Selection = Multi-Function Digital Input*] and  $b1-01 \neq 3$  [*Frequency Reference Selection 1  $\neq$  Option PCB*] to use digital input option DI-A3 as an MFDI.

Use  $F3-10$  to  $F3-25$  [*Terminal D0 Function Selection to Terminal DF Function Selection*] to set the function for the DI-A3 terminals.

**Note:**

- Refer to  $H1-xx$  "Multi-function Digital Input Setting Values" for more information about MFDI setting values.
- Values 0 [*3-Wire Sequence*] and 20 to 2F [*External Fault*] for  $F3-10$  to  $F3-25$ .
- When you do not use DI-A3 as an MFDI, set  $F3-10$  to  $F3-25 = F$  [*Not Used*].
- The drive reads DI-A3 terminal Dx two times as specified by parameter  $b1-06$  [*Digital Input Reading*].
- Configuring such that  $F3-01 = 8$  when DI-A3 is the frequency reference source ( $b1-01$  or  $b1-15 = 3$  [*Frequency Reference Selection 1 / 2 = Option PCB*]) results in the detection of  $oPE05$  [*Run Cmd/Freq Ref Source Sel Err*].
- You can use these functions with the DI-A3 MFDI:
  - $H1-40$  to  $H1-42$  [*Mbus Reg 15C0h bit0 to bit2 Input Func*]
  - $H7-01$  to  $H7-04$  [*Virtual Multi-Function Input 1 to 4*]

### ■ F3-01: Digital Input Function Selection

No. (Hex.)	Name	Description	Default (Range)
F3-01 (0390)	Digital Input Function Selection	<div style="display: flex; justify-content: space-between; font-size: small;"> <span>V/f</span> <span>CL-V/f</span> <span>OLV</span> <span>CLV</span> <span>AOLV</span> <span>OLV/PM</span> <span>AOLV/PM</span> <span>CLV/PM</span> <span>EZOLV</span> </div> Sets the data format of digital input signals. Set <i>o1-03</i> = 0 or 1 [ <i>Frequency Display Unit Selection</i> = 0.01 Hz or 0.01% (100% = E1-04)] to enable this function.	0 (0 - 8)

**Note:**

The input signal type is BCD when *o1-03* = 2 or 3 [*Revolutions Per Minute (RPM) or User Units (o1-10 & o1-11)*]. The *o1-03* value sets the setting units.

**0 : BCD, 1% units**

**1 : BCD, 0.1% units**

**2 : BCD, 0.01% units**

**3 : BCD, 1 Hz units**

**4 : BCD, 0.1 Hz units**

**5 : BCD, 0.01 Hz units**

**6 : BCD (5-digit), 0.01 Hz**

**7 : Binary input**

The setting unit and setting range vary depending on the value set in *F3-03* [*Digital Input Data Length Select*].

- *F3-03* = 0 [*8-bit*]: 100%/255 (-255 to +255)
- *F3-03* = 1 [*12-bit*]: 100%/4095 (-4095 to +4095)
- *F3-03* = 2 [*16-bit*]: 100%/30000 (-33000 to +33000)

### 8 : Multi-Function Digital Input

The DI-A3 card is also used as a multi-function digital input terminal.

### ■ F3-03: Digital Input Data Length Select

No. (Hex.)	Name	Description	Default (Range)
F3-03 (03B9)	Digital Input Data Length Select	<div style="display: flex; justify-content: space-between; font-size: small;"> <span>V/f</span> <span>CL-V/f</span> <span>OLV</span> <span>CLV</span> <span>AOLV</span> <span>OLV/PM</span> <span>AOLV/PM</span> <span>CLV/PM</span> <span>EZOLV</span> </div> Sets the number of bits to set the frequency reference with <i>DI-A3</i> .	2 (0 - 2)

**0 : 8-bit**

**1 : 12-bit**

**2 : 16-bit**

Table 11.50 DI-A3 Terminal Function Selection

Terminal Block	Terminal Name	BCD, Signed [F3-01 = 0 to 5]						BCD, Unsigned [F3-01 = 6] <sup>*1</sup>		Binary, Signed [F3-01 = 7]			
		8-bit [F3-03 = 0]		12-bit [F3-03 = 1]		16-bit [F3-03 = 2]				8-bit [F3-03 = 0]	12-bit [F3-03 = 1]	16-bit [F3-03 = 2]	
TB2	D0	1 digit (0 - 9)	1	1 digit (0 - 9)	1	1 digit (0 - 9)	1	1 digit (0, 2, 4, 6, 8)	2	bit 0	bit 0	bit 0	
	D1		2		2		2		4	bit 1	bit 1	bit 1	
	D2		4		4		4		8	bit 2	bit 2	bit 2	
	D3		8		8		8		2 digits (0 - 9)	1	bit 3	bit 3	bit 3
	D4	2 digits (0 - 15) <sup>*2</sup>	1	2 digits (0 - 9)	1	2 digits (0 - 9)	1	2		bit 4	bit 4	bit 4	
	D5		2		2		2	4		bit 5	bit 5	bit 5	
	D6		4		4		4	8		bit 6	bit 6	bit 6	
	D7		8		8		8	3 digits (0 - 9)	1	bit 7	bit 7	bit 7	
TB3	D8	-	-	3 digits (0 - 15) <sup>*2</sup>	1	3 digits (0 - 9)	-		4 digits (0 - 9)	2	-	bit 8	bit 8
	D9	-	-		2		-			4	-	bit 9	bit 9
	DA	-	-		4		-			8	-	bit 10	bit 10
	DB	-	-		8		-	5 digits (0 - 3)		1	-	bit 11	bit 11
	DC	-	-	-	4 digits (0 - 15) <sup>*2</sup>	-	2		-	-	bit 12		
	DD	-	-	-		-	4		-	-	bit 13		
	DE	-	-	-		-	8		-	-	bit 14		
	DF	-	-	-		-	-	1	-	-	bit 15		
TB1	SI	SIGN (encoded) signal 0: Forward run, 1: Reverse run						2	SIGN (encoded) signal 0: Forward run, 1: Reverse run				
	SE	SET (loaded) signal 1: Loads the value set for D0 to DF and SI.											
	SP	Internal power supply: 24 V ± 5%											
	SC	Input signal common											
	SN	Internal power supply common: 0 V											
	SD	Cable sheath connection terminal (ungrounded)											
	FE	Cable sheath connection terminal (grounded)											

\*1 Setting  $F3-03 = 2$  [Digital Input Data Length Select = 16-bit] enables  $F3-01 = 6$  [Digital Input Function Selection = BCD (5-digit), 0.01 Hz] and a frequency between 0.00 Hz to 399.8 Hz can be set by the BCD. Note that terminal SI is also used as for data bits. Negative commands cannot be input as encoding information (positive/negative) cannot be added to the data.

The minimum bit value for the first BCD digit is 2. For this reason, 0.02 Hz is the smallest setting unit available for this frequency setting. An *oPE05* [Run Cmd/Freq Ref Source Sel Err] occurs when  $F3-03 \neq 2$  while  $F3-01 = 6$ .

\*2 The most significant digit can be set to a value between 0 to 15 when using "BCD, Signed". Other digits can be set to a value between 0 to 9.

### ■ F3-10: Terminal D0 Function Selection

No. (Hex.)	Name	Description	Default (Range)
F3-10 (0BE3) Expert	Terminal D0 Function Selection	<div style="display: flex; gap: 5px;"> <span>V/f</span> <span>CL-V/f</span> <span>OLV</span> <span>CLV</span> <span>AOLV</span> <span>OLV/PM</span> <span>AOLV/PM</span> <span>CLV/PM</span> <span>EZOLV</span> </div> Sets the function for terminal D0 of the DI-A3 when $F3-01 = 8$ [Digital Input Function Selection = Multi-Function Digital Input].	F (1 - 19F)

### ■ F3-11: Terminal D1 Function Selection

No. (Hex.)	Name	Description	Default (Range)
F3-11 (0BE4) Expert	Terminal D1 Function Selection	<div style="display: flex; justify-content: space-between; font-size: 0.8em; font-weight: bold;"> <span>V/f</span> <span>CL-V/f</span> <span>OLV</span> <span>CLV</span> <span>AOLV</span> <span>OLV/PM</span> <span>AOLV/PM</span> <span>CLV/PM</span> <span>EZOLV</span> </div> Sets the function for terminal D1 of the DI-A3 when $F3-01 = 8$ [Digital Input Function Selection = Multi-Function Digital Input].	F (1 - 19F)

### ■ F3-12: Terminal D2 Function Selection

No. (Hex.)	Name	Description	Default (Range)
F3-12 (0BE5) Expert	Terminal D2 Function Selection	<div style="display: flex; justify-content: space-between; font-size: 0.8em; font-weight: bold;"> <span>V/f</span> <span>CL-V/f</span> <span>OLV</span> <span>CLV</span> <span>AOLV</span> <span>OLV/PM</span> <span>AOLV/PM</span> <span>CLV/PM</span> <span>EZOLV</span> </div> Sets the function for terminal D2 of the DI-A3 when $F3-01 = 8$ [Digital Input Function Selection = Multi-Function Digital Input].	F (1 - 19F)

### ■ F3-13: Terminal D3 Function Selection

No. (Hex.)	Name	Description	Default (Range)
F3-13 (0BE6) Expert	Terminal D3 Function Selection	<div style="display: flex; justify-content: space-between; font-size: 0.8em; font-weight: bold;"> <span>V/f</span> <span>CL-V/f</span> <span>OLV</span> <span>CLV</span> <span>AOLV</span> <span>OLV/PM</span> <span>AOLV/PM</span> <span>CLV/PM</span> <span>EZOLV</span> </div> Sets the function for terminal D3 of the DI-A3 when $F3-01 = 8$ [Digital Input Function Selection = Multi-Function Digital Input].	F (1 - 19F)

### ■ F3-14: Terminal D4 Function Selection

No. (Hex.)	Name	Description	Default (Range)
F3-14 (0BE7) Expert	Terminal D4 Function Selection	<div style="display: flex; justify-content: space-between; font-size: 0.8em; font-weight: bold;"> <span>V/f</span> <span>CL-V/f</span> <span>OLV</span> <span>CLV</span> <span>AOLV</span> <span>OLV/PM</span> <span>AOLV/PM</span> <span>CLV/PM</span> <span>EZOLV</span> </div> Sets the function for terminal D4 of the DI-A3 when $F3-01 = 8$ [Digital Input Function Selection = Multi-Function Digital Input].	F (1 - 19F)

### ■ F3-15: Terminal D5 Function Selection

No. (Hex.)	Name	Description	Default (Range)
F3-15 (0BE8) Expert	Terminal D5 Function Selection	<div style="display: flex; justify-content: space-between; font-size: 0.8em; font-weight: bold;"> <span>V/f</span> <span>CL-V/f</span> <span>OLV</span> <span>CLV</span> <span>AOLV</span> <span>OLV/PM</span> <span>AOLV/PM</span> <span>CLV/PM</span> <span>EZOLV</span> </div> Sets the function for terminal D5 of the DI-A3 when $F3-01 = 8$ [Digital Input Function Selection = Multi-Function Digital Input].	F (1 - 19F)

### ■ F3-16: Terminal D6 Function Selection

No. (Hex.)	Name	Description	Default (Range)
F3-16 (0BE9) Expert	Terminal D6 Function Selection	<div style="display: flex; justify-content: space-between; font-size: 0.8em; font-weight: bold;"> <span>V/f</span> <span>CL-V/f</span> <span>OLV</span> <span>CLV</span> <span>AOLV</span> <span>OLV/PM</span> <span>AOLV/PM</span> <span>CLV/PM</span> <span>EZOLV</span> </div> Sets the function for terminal D6 of the DI-A3 when $F3-01 = 8$ [Digital Input Function Selection = Multi-Function Digital Input].	F (1 - 19F)

### ■ F3-17: Terminal D7 Function Selection

No. (Hex.)	Name	Description	Default (Range)
F3-17 (0BEA) Expert	Terminal D7 Function Selection	<div style="display: flex; justify-content: space-between; font-size: 0.8em; font-weight: bold;"> <span>V/f</span> <span>CL-V/f</span> <span>OLV</span> <span>CLV</span> <span>AOLV</span> <span>OLV/PM</span> <span>AOLV/PM</span> <span>CLV/PM</span> <span>EZOLV</span> </div> Sets the function for terminal D7 of the DI-A3 when $F3-01 = 8$ [Digital Input Function Selection = Multi-Function Digital Input].	F (1 - 19F)



### ■ F3-18: Terminal D8 Function Selection

No. (Hex.)	Name	Description	Default (Range)
F3-18 (0BEB) Expert	Terminal D8 Function Selection	<b>V/f</b> <b>CL-V/f</b> <b>OLV</b> <b>CLV</b> <b>AOLV</b> <b>OLV/PM</b> <b>AOLV/PM</b> <b>CLV/PM</b> <b>EZOLV</b> Sets the function for terminal D8 of the DI-A3 when $F3-01 = 8$ [Digital Input Function Selection = Multi-Function Digital Input].	F (1 - 19F)

### ■ F3-19: Terminal D9 Function Selection

No. (Hex.)	Name	Description	Default (Range)
F3-19 (0BEC) Expert	Terminal D9 Function Selection	<b>V/f</b> <b>CL-V/f</b> <b>OLV</b> <b>CLV</b> <b>AOLV</b> <b>OLV/PM</b> <b>AOLV/PM</b> <b>CLV/PM</b> <b>EZOLV</b> Sets the function for terminal D9 of the DI-A3 when $F3-01 = 8$ [Digital Input Function Selection = Multi-Function Digital Input].	F (1 - 19F)

### ■ F3-20: Terminal DA Function Selection

No. (Hex.)	Name	Description	Default (Range)
F3-20 (0BED) Expert	Terminal DA Function Selection	<b>V/f</b> <b>CL-V/f</b> <b>OLV</b> <b>CLV</b> <b>AOLV</b> <b>OLV/PM</b> <b>AOLV/PM</b> <b>CLV/PM</b> <b>EZOLV</b> Sets the function for terminal DA of the DI-A3 when $F3-01 = 8$ [Digital Input Function Selection = Multi-Function Digital Input].	F (1 - 19F)

### ■ F3-21: Terminal DB Function Selection

No. (Hex.)	Name	Description	Default (Range)
F3-21 (0BEE) Expert	Terminal DB Function Selection	<b>V/f</b> <b>CL-V/f</b> <b>OLV</b> <b>CLV</b> <b>AOLV</b> <b>OLV/PM</b> <b>AOLV/PM</b> <b>CLV/PM</b> <b>EZOLV</b> Sets the function for terminal DB of the DI-A3 when $F3-01 = 8$ [Digital Input Function Selection = Multi-Function Digital Input].	F (1 - 19F)

### ■ F3-22: Terminal DC Function Selection

No. (Hex.)	Name	Description	Default (Range)
F3-22 (0BEF) Expert	Terminal DC Function Selection	<b>V/f</b> <b>CL-V/f</b> <b>OLV</b> <b>CLV</b> <b>AOLV</b> <b>OLV/PM</b> <b>AOLV/PM</b> <b>CLV/PM</b> <b>EZOLV</b> Sets the function for terminal DC of the DI-A3 when $F3-01 = 8$ [Digital Input Function Selection = Multi-Function Digital Input].	F (1 - 19F)

### ■ F3-23: Terminal DD Function Selection

No. (Hex.)	Name	Description	Default (Range)
F3-23 (0BF0) Expert	Terminal DD Function Selection	<b>V/f</b> <b>CL-V/f</b> <b>OLV</b> <b>CLV</b> <b>AOLV</b> <b>OLV/PM</b> <b>AOLV/PM</b> <b>CLV/PM</b> <b>EZOLV</b> Sets the function for terminal DD of the DI-A3 when $F3-01 = 8$ [Digital Input Function Selection = Multi-Function Digital Input].	F (1 - 19F)

### ■ F3-24: Terminal DE Function Selection

No. (Hex.)	Name	Description	Default (Range)
F3-24 (0BF1) Expert	Terminal DE Function Selection	<b>V/f</b> <b>CL-V/f</b> <b>OLV</b> <b>CLV</b> <b>AOLV</b> <b>OLV/PM</b> <b>AOLV/PM</b> <b>CLV/PM</b> <b>EZOLV</b> Sets the function for terminal DE of the DI-A3 when $F3-01 = 8$ [Digital Input Function Selection = Multi-Function Digital Input].	F (1 - 19F)

### ■ F3-25: Terminal DF Function Selection

No. (Hex.)	Name	Description	Default (Range)
F3-25 (0BF2) Expert	Terminal DF Function Selection	<div style="display: flex; justify-content: space-between; font-size: 0.8em; font-weight: bold; margin-bottom: 5px;"> <span>V/f</span> <span>CL-V/f</span> <span>OLV</span> <span>CLV</span> <span>AOLV</span> <span>OLV/PM</span> <span>AOLV/PM</span> <span>CLV/PM</span> <span>EZOLV</span> </div> Sets the function for terminal DF of the DI-A3 when $F3-01 = 8$ [Digital Input Function Selection = Multi-Function Digital Input].	F (1 - 19F)

### ◆ F4: Analog Monitor Option

*F4 parameters* set drive operation when you use analog monitor option card AO-A3. The AO-A3 card has 2 output terminals (terminals V1 and V2) for signals with an Output resolution of 11 bits (1/2048) + encoding and that have an output voltage range of -10 V to +10 V. Install the AO-A3 card to a drive to output analog signals that monitor the output status of the drive (output frequency and output current).

Refer to the AO-A3 card manual for more information about how to install, wire, and set the AO-A3 card.

Use the *U monitor* number to set the monitor data to be output from terminals V1 and V2 on the AO-A3 card. Enter the last three digits of *Ux-xx* as the setting value.

- Use Gain and Bias to Adjust the Output Signal Level of Terminal V1

You must stop the drive to adjust the output signal. Use this procedure to calibrate the drive:

1. View the *F4-02 [Terminal V1 Gain]* value on the keypad.  
Terminal V1 will output a voltage = 100% of the monitor set in *F4-01 [Terminal V1 Function Selection]*.
2. View the monitor connected to terminal V1 and adjust *F4-02*.
3. View the *F4-05 [Terminal V1 Bias]* value on the keypad.  
Terminal V1 will output an analog signal = 100% of the parameter set in *F4-01*.
4. View the monitor connected to terminal V1 and adjust *F4-05*.

- Use Gain and Bias to Adjust the Output Signal Level of Terminal V2

You must stop the drive to adjust the output signal. Use this procedure to calibrate the drive:

1. View the *F4-04 [Terminal V2 Gain]* value on the keypad.  
Terminal V2 will output a voltage = 100% of the monitor set in *F4-03 [Terminal V2 Function Selection]*.
2. View the monitor connected to terminal V2 and adjust *F4-04*.
3. View the *F4-06 [Terminal V2 Bias]* value on the keypad.  
The analog signal equal to 0% of the parameter being set in *F4-03* will be output from terminal V2.
4. View the monitor connected to terminal V2 and adjust *F4-06*.

### ■ F4-01: Terminal V1 Function Selection

No. (Hex.)	Name	Description	Default (Range)
F4-01 (0391)	Terminal V1 Function Selection	<div style="display: flex; justify-content: space-between; font-size: 0.8em; font-weight: bold; margin-bottom: 5px;"> <span>V/f</span> <span>CL-V/f</span> <span>OLV</span> <span>CLV</span> <span>AOLV</span> <span>OLV/PM</span> <span>AOLV/PM</span> <span>CLV/PM</span> <span>EZOLV</span> </div> Sets the monitor signal output from terminal V1.	102 (000 - 999)

Enter the last three digits of *Ux-xx [Monitors]* to set monitor data to output from the option card. For example, set *x-xx* to *102* to monitor *U1-02 [Output Frequency]*.

**Note:**

- You cannot use all of the monitors in all of the control methods.
- When you use the terminal in through mode, set *000* or *031*. You can use this setting to adjust the V1 terminal output from PLC through MEMOBUS/Modbus communications or a communications option.

### ■ F4-02: Terminal V1 Gain

No. (Hex.)	Name	Description	Default (Range)
F4-02 (0392) RUN	Terminal V1 Gain	<div style="display: flex; justify-content: space-between; font-size: 0.8em; font-weight: bold; margin-bottom: 5px;"> <span>V/f</span> <span>CL-V/f</span> <span>OLV</span> <span>CLV</span> <span>AOLV</span> <span>OLV/PM</span> <span>AOLV/PM</span> <span>CLV/PM</span> <span>EZOLV</span> </div> Sets the gain of the monitor signal that is sent from terminal V1. Sets the analog signal output level from the terminal V1 at 10 V or 20 mA as 100% when an output for monitoring items is 100%.	100.0% (-999.9 - +999.9%)

The maximum output voltage output from terminal V1 is  $\pm 10$  V. Use *F4-07 [Terminal V1 Signal Level]* to set the signal level.

Example settings:

When you use these settings, and the monitored output voltage is at 100% (drive rated current), the output voltage of terminal V1 is 5 V (50% of 10 V). The output current is 200% of the drive rated current when terminal V1 outputs a maximum voltage of 10 V.

- F4-01 [Terminal V1 Function Selection] = 102 (U1-02: Output Frequency)
- F4-02 = 50.0%
- F4-05 [Terminal V1 Bias] = 0.0%
- F4-07 = 0 (0 V to 10 V)

### ■ F4-03: Terminal V2 Function Selection

No. (Hex.)	Name	Description	Default (Range)
F4-03 (0393)	Terminal V2 Function Selection	<b>V/f</b> <b>CL-V/f</b> <b>OLV</b> <b>CLV</b> <b>AOLV</b> <b>OLV/PM</b> <b>AOLV/PM</b> <b>CLV/PM</b> <b>EZOLV</b> Sets the number for monitor item of output from terminal V2.	103 (000 - 999)

Enter the last three digits of  $Ux-xx$  [Monitors] to set monitor data to output from the option card. For example, set  $x-xx$  to 103 to monitor  $U1-03$  [Output Current].

**Note:**

- You cannot use all of the monitors in all of the control methods.
- When you use the terminal in through mode, set 000 or 031. You can use this setting to adjust the V2 terminal output from PLC through MEMOBUS/Modbus communications or a communications option.

### ■ F4-04: Terminal V2 Gain

No. (Hex.)	Name	Description	Default (Range)
F4-04 (0394) RUN	Terminal V2 Gain	<b>V/f</b> <b>CL-V/f</b> <b>OLV</b> <b>CLV</b> <b>AOLV</b> <b>OLV/PM</b> <b>AOLV/PM</b> <b>CLV/PM</b> <b>EZOLV</b> Sets the gain of the monitor signal that is sent from terminal V2.	50.0% (-999.9 - +999.9%)

The maximum output voltage output from terminal V2 is  $\pm 10$  V. Use  $F4-08$  [Terminal V2 Signal Level] to set the signal level.

Example settings:

When you use these settings, and the monitored output voltage is at 100% (drive rated current), the output voltage of terminal V2 is 5 V (50% of 10 V). The output current is 200% of the drive rated current when terminal V2 outputs a maximum voltage of 10 V.

- F4-03 [Terminal V2 Function Selection] = 103 (U1-03: Output Current)
- F4-04 = 50.0%
- F4-06 [Terminal V2 Bias] = 0.0%
- F4-08 = 0 (0 V to 10 V)

### ■ F4-05: Terminal V1 Bias

No. (Hex.)	Name	Description	Default (Range)
F4-05 (0395) RUN	Terminal V1 Bias	<b>V/f</b> <b>CL-V/f</b> <b>OLV</b> <b>CLV</b> <b>AOLV</b> <b>OLV/PM</b> <b>AOLV/PM</b> <b>CLV/PM</b> <b>EZOLV</b> Sets the bias of the monitor signal that is sent from terminal V1. Set the level of the analog signal sent from the V1 terminal at 10 V or 20 mA as 100% when an output for monitoring items is 0%.	0.0% (-999.9 - +999.9%)

The maximum output voltage output from terminal V1 is  $\pm 10$  V. Use  $F4-07$  [Terminal V1 Signal Level] to set the signal level.

### ■ F4-06: Terminal V2 Bias

No. (Hex.)	Name	Description	Default (Range)
F4-06 (0396) RUN	Terminal V2 Bias	<div style="display: flex; justify-content: space-between; font-size: 0.8em; font-weight: bold; margin-bottom: 5px;"> <span>V/f</span> <span>CL-V/f</span> <span>OLV</span> <span>CLV</span> <span>AOLV</span> <span>OLV/PM</span> <span>AOLV/PM</span> <span>CLV/PM</span> <span>EZOLV</span> </div> Sets the bias of the monitor signal that is sent from terminal V2. Set the level of the analog signal sent from the V2 terminal at 10 V or 20 mA as 100% when an output for monitoring items is 0%.	0.0% (-999.9 - +999.9%)

The maximum output voltage output from terminal V2 is  $\pm 10$  V. Use *F4-08 [Terminal V2 Signal Level]* to set the signal level.

### ■ F4-07: Terminal V1 Signal Level

No. (Hex.)	Name	Description	Default (Range)
F4-07 (0397)	Terminal V1 Signal Level	<div style="display: flex; justify-content: space-between; font-size: 0.8em; font-weight: bold; margin-bottom: 5px;"> <span>V/f</span> <span>CL-V/f</span> <span>OLV</span> <span>CLV</span> <span>AOLV</span> <span>OLV/PM</span> <span>AOLV/PM</span> <span>CLV/PM</span> <span>EZOLV</span> </div> Sets the output signal level for terminal V1.	0 (0, 1)

0 : 0 to 10 V

1 : -10 to 10 V

### ■ F4-08: Terminal V2 Signal Level

No. (Hex.)	Name	Description	Default (Range)
F4-08 (0398)	Terminal V2 Signal Level	<div style="display: flex; justify-content: space-between; font-size: 0.8em; font-weight: bold; margin-bottom: 5px;"> <span>V/f</span> <span>CL-V/f</span> <span>OLV</span> <span>CLV</span> <span>AOLV</span> <span>OLV/PM</span> <span>AOLV/PM</span> <span>CLV/PM</span> <span>EZOLV</span> </div> Sets the output signal level for terminal V2.	0 (0, 1)

0 : 0 to 10 V

1 : -10 to 10 V

## ◆ F5: Digital Output Option

*F5 parameters* set the output mode and function of output signals when you use digital output option card DO-A3. When you install a DO-A3 to the drive, you can output isolated digital signals to monitor the drive operation status.

- 6 points of photocoupler output (48 V, 50 mA or less)
- 2 points of relay contact output (250 Vac, 30 Vdc: 1 A or less)

Refer to the DO-A3 option manual for more information about how to install, wire, and set the DO-A3 card.

### ■ Use Parameters to Select Output Modes

Use parameter *F5-09 [DO-A3 Output Mode Selection]* to set signal output from the DO-A3 card.

Table 11.51 Details of F5-09 and the DO-A3 Terminal Output

DO-A3 Terminal Block	DO-A3 Terminal Name	F5-09 = 0 [Predefined Individual Outputs] (Default)	F5-09 = 1 [Binary Output]	F5-09 = 2 [Programmable (F5-01 to F5-08)]
TB1	M1-M2	Zero speed detection in progress	During run	Depending on the setting of F5-07 [Terminal M1-M2 Function Select]
	M3-M4	During speed agreement	Minor fault (excluding bb [Baseblock])	Depending on the setting of F5-08 [Terminal M3-M4 Function Select]
TB2	P1-PC	oC [Overcurrent], GF [Ground Fault]	Coded output <b>Note:</b> Refer to <a href="#">Table 11.52</a> for details.	Depending on the setting of F5-01 [Terminal P1-PC Function Select]
	P2-PC	ov [Overvoltage]		Depending on the setting of F5-02 [Terminal P2-PC Function Select]
	P3-PC	oL2 [Drive Overload] or oH2 [Heatsink Overheat]		Depending on the setting of F5-03 [Terminal P3-PC Function Select]
	P4-PC	Not used		Depending on the setting of F5-04 [Terminal P4-PC Function Select]
	P5-PC	oS [Overspeed]	Zero speed detection in progress	Depending on the setting of F5-05 [Terminal P5-PC Function Select]
	P6-PC	oH, oH1 [Heatsink Overheat] or oL1 [Motor Overload]	During speed agreement	Depending on the setting of F5-06 [Terminal P6-PC Function Select]

Table 11.52 Binary Output [F5-09 = 1]

Coded Output (Binary)	Description	DO-A3 Terminal Block TB2			
		Terminal P1-PC	Terminal P2-PC	Terminal P3-PC	Terminal P4-PC
0	No fault	0	0	0	0
1	oC [Overcurrent], GF [Ground Fault]	1	0	0	0
2	ov [Overvoltage]	0	1	0	0
3	oL2 [Drive Overloaded]	1	1	0	0
4	oH, oH1 [Heatsink Overheat]	0	0	1	0
5	oS [Overspeed]	1	0	1	0
6	Not used	0	1	1	0
7	rr [Dynamic Braking Transistor Fault], rH [Braking Resistor Overheat]	1	1	1	0
8	External fault [EF1 to EF8]	0	0	0	1
9	CPFxx, oFAxx, oFbxx, oFCxx [Drive Hardware Fault] <sup>*/</sup>	1	0	0	1
A	oL1 [Motor Overload]	0	1	0	1
B	Not used	1	1	0	1
C	Uv1, Uv2 [Undervoltage], Uv3 [Soft Charge Answerback Fault]	0	0	1	1
D	dEv [Speed Deviation]	1	0	1	1

Coded Output (Binary)	Description	DO-A3 Terminal Block TB2			
		Terminal P1-PC	Terminal P2-PC	Terminal P3-PC	Terminal P4-PC
E	PGo [Encoder (PG) Feedback Loss]	0	1	1	1
F	Not used	1	1	1	1

\*1 The “xx” characters are different for different faults.

### ■ Digital Output Card Selection

Refer to “H2: Multi-function Digital Output” for more information about the functions that output from the terminals when  $F5-09 = 2$  [DO-A3 Output Mode Selection = Programmable (F5-01 to F5-08)]. Use F5-01 to F5-08 to set the output items.

No.	Name	Setting Range	Default
F5-01	Terminal P1-PC Function Select	0 - 192	0: During Run
F5-02	Terminal P2-PC Function Select	0 - 192	1: Zero Speed
F5-03	Terminal P3-PC Function Select	0 - 192	2: Speed Agree 1
F5-04	Terminal P4-PC Function Select	0 - 192	4: Frequency Detection 1
F5-05	Terminal P5-PC Function Select	0 - 192	6: Drive Ready
F5-06	Terminal P6-PC Function Select	0 - 192	37: During Frequency Output
F5-07	Terminal M1-M2 Function Select	0 - 192	F: Not Used
F5-08	Terminal M3-M4 Function Select	0 - 192	F: Not Used

### ■ F5-01: Terminal P1-PC Function Select

No. (Hex.)	Name	Description	Default (Range)
F5-01 (0399)	Terminal P1-PC Function Select	<div style="display: flex; justify-content: space-between; align-items: center;"> <span><input type="checkbox"/> V/f</span> <span><input type="checkbox"/> CL-V/f</span> <span><input type="checkbox"/> OLV</span> <span><input type="checkbox"/> CLV</span> <span><input type="checkbox"/> AOLV</span> <span><input type="checkbox"/> OLVP/M</span> <span><input type="checkbox"/> AOLVP/M</span> <span><input type="checkbox"/> CLVP/M</span> <span><input type="checkbox"/> EZOLV</span> </div> <p>Sets the function of terminal P1-PC on the DO-A3 option. Set <math>F5-09 = 2</math> [DO-A3 Output Mode Selection = Programmable (F5-01 to F5-08)] to enable this function.</p>	0 (0 - 1A7)

### ■ F5-02: Terminal P2-PC Function Select

No. (Hex.)	Name	Description	Default (Range)
F5-02 (039A)	Terminal P2-PC Function Select	<div style="display: flex; justify-content: space-between; align-items: center;"> <span><input type="checkbox"/> V/f</span> <span><input type="checkbox"/> CL-V/f</span> <span><input type="checkbox"/> OLV</span> <span><input type="checkbox"/> CLV</span> <span><input type="checkbox"/> AOLV</span> <span><input type="checkbox"/> OLVP/M</span> <span><input type="checkbox"/> AOLVP/M</span> <span><input type="checkbox"/> CLVP/M</span> <span><input type="checkbox"/> EZOLV</span> </div> <p>Sets the function of terminal P2-PC on the DO-A3 option. Set <math>F5-09 = 2</math> [DO-A3 Output Mode Selection = Programmable (F5-01 to F5-08)] to enable this function.</p>	1 (0 - 1A7)

### ■ F5-03: Terminal P3-PC Function Select

No. (Hex.)	Name	Description	Default (Range)
F5-03 (039B)	Terminal P3-PC Function Select	<div style="display: flex; justify-content: space-between; align-items: center;"> <span><input type="checkbox"/> V/f</span> <span><input type="checkbox"/> CL-V/f</span> <span><input type="checkbox"/> OLV</span> <span><input type="checkbox"/> CLV</span> <span><input type="checkbox"/> AOLV</span> <span><input type="checkbox"/> OLVP/M</span> <span><input type="checkbox"/> AOLVP/M</span> <span><input type="checkbox"/> CLVP/M</span> <span><input type="checkbox"/> EZOLV</span> </div> <p>Sets the function of terminal P3-PC on the DO-A3 option. Set <math>F5-09 = 2</math> [DO-A3 Output Mode Selection = Programmable (F5-01 to F5-08)] to enable this function.</p>	2 (0 - 1A7)

### ■ F5-04: Terminal P4-PC Function Select

No. (Hex.)	Name	Description	Default (Range)
F5-04 (039C)	Terminal P4-PC Function Select	<div style="display: flex; justify-content: space-between; align-items: center;"> <span><input type="checkbox"/> V/f</span> <span><input type="checkbox"/> CL-V/f</span> <span><input type="checkbox"/> OLV</span> <span><input type="checkbox"/> CLV</span> <span><input type="checkbox"/> AOLV</span> <span><input type="checkbox"/> OLVP/M</span> <span><input type="checkbox"/> AOLVP/M</span> <span><input type="checkbox"/> CLVP/M</span> <span><input type="checkbox"/> EZOLV</span> </div> <p>Sets the function of terminal P4-PC on the DO-A3 option. Set <math>F5-09 = 2</math> [DO-A3 Output Mode Selection = Programmable (F5-01 to F5-08)] to enable this function.</p>	4 (0 - 1A7)

### ■ F5-05: Terminal P5-PC Function Select

No. (Hex.)	Name	Description	Default (Range)
F5-05 (039D)	Terminal P5-PC Function Select	<div style="display: flex; justify-content: space-between; font-size: 0.8em; font-weight: bold; margin-bottom: 5px;"> <span>V/f</span> <span>CL-V/f</span> <span>OLV</span> <span>CLV</span> <span>AOLV</span> <span>OLV/PM</span> <span>AOLV/PM</span> <span>CLV/PM</span> <span>EZOLV</span> </div> Sets the function of terminal P5-PC on the DO-A3 option. Set $F5-09 = 2$ [DO-A3 Output Mode Selection = Programmable (F5-01 to F5-08)] to enable this function.	6 (0 - 1A7)

### ■ F5-06: Terminal P6-PC Function Select

No. (Hex.)	Name	Description	Default (Range)
F5-06 (039E)	Terminal P6-PC Function Select	<div style="display: flex; justify-content: space-between; font-size: 0.8em; font-weight: bold; margin-bottom: 5px;"> <span>V/f</span> <span>CL-V/f</span> <span>OLV</span> <span>CLV</span> <span>AOLV</span> <span>OLV/PM</span> <span>AOLV/PM</span> <span>CLV/PM</span> <span>EZOLV</span> </div> Sets the function of terminal P6-PC on the DO-A3 option. Set $F5-09 = 2$ [DO-A3 Output Mode Selection = Programmable (F5-01 to F5-08)] to enable this function.	37 (0 - 1A7)

### ■ F5-07: Terminal M1-M2 Function Select

No. (Hex.)	Name	Description	Default (Range)
F5-07 (039F)	Terminal M1-M2 Function Select	<div style="display: flex; justify-content: space-between; font-size: 0.8em; font-weight: bold; margin-bottom: 5px;"> <span>V/f</span> <span>CL-V/f</span> <span>OLV</span> <span>CLV</span> <span>AOLV</span> <span>OLV/PM</span> <span>AOLV/PM</span> <span>CLV/PM</span> <span>EZOLV</span> </div> Sets the function of terminal M3-M2 on the DO-A3 option. Set $F5-09 = 2$ [DO-A3 Output Mode Selection = Programmable (F5-01 to F5-08)] to enable this function.	F (0 - 1A7)

### ■ F5-08: Terminal M3-M4 Function Select

No. (Hex.)	Name	Description	Default (Range)
F5-08 (03A0)	Terminal M3-M4 Function Select	<div style="display: flex; justify-content: space-between; font-size: 0.8em; font-weight: bold; margin-bottom: 5px;"> <span>V/f</span> <span>CL-V/f</span> <span>OLV</span> <span>CLV</span> <span>AOLV</span> <span>OLV/PM</span> <span>AOLV/PM</span> <span>CLV/PM</span> <span>EZOLV</span> </div> Sets the function of terminal M3-M4 on the DO-A3 option. Set $F5-09 = 2$ [DO-A3 Output Mode Selection = Programmable (F5-01 to F5-08)] to enable this function.	F (0 - 1A7)

### ■ F5-09: DO-A3 Output Mode Selection

No. (Hex.)	Name	Description	Default (Range)
F5-09 (03A1)	DO-A3 Output Mode Selection	<div style="display: flex; justify-content: space-between; font-size: 0.8em; font-weight: bold; margin-bottom: 5px;"> <span>V/f</span> <span>CL-V/f</span> <span>OLV</span> <span>CLV</span> <span>AOLV</span> <span>OLV/PM</span> <span>AOLV/PM</span> <span>CLV/PM</span> <span>EZOLV</span> </div> Sets the output mode of signals from the DO-A3 option.	0 (0 - 2)

Refer to [Table 11.51](#) for more information.

#### 0 : Predefined Individual Outputs

#### 1 : Binary Output

#### 2 : Programmable (F5-01 to F5-08)

## ◆ F6, F7: Communication Options

*F6 and F7 parameters* are used to set the basic communication settings and method of fault detection for the communication option card. The communication option card parameters include common option card parameters and communication protocol-specific parameters.

The following table lists the parameters that need to be set for each communication option card.

Refer to the technical manual for each communication option card for more information on installing, wiring, and configuring the details needed before starting communication.

**WARNING!** *Sudden Movement Hazard. Do test runs and examine the drive to make sure that command references are configured correctly. If you set the command reference incorrectly, it can cause death, serious injury, or equipment damage from unwanted motor rotation.*

**Table 11.53 Correspondence Between Communication Protocols and Parameters (SI-CB, SI-T3, SI-ET3, SI-P3, SI-S3, and SI-ES3)**

Parameters	CC-Link SI-C3	MECHATRO LINK-II SI-T3	MECHATRO LINK-III SI-ET3	PROFIBUS-DP SI-P3	CANopen SI-S3	EtherCAT SI-ES3
F6-01 to F6-03	x	x	x	x	x	x
F6-04	x	-	-	-	-	-
F6-06 to F6-08	x	x	x	x	x	x
F6-10 and F6-11	x	-	-	-	-	-
F6-14	x	x	x	x	x	x
F6-16	x	x	x	x	x	x
F6-20 and F6-21	-	x	x	-	-	-
F6-22	-	x	-	-	-	-
F6-23 to F6-26	-	x	x	-	-	-
F6-30 to F6-32	-	-	-	x	-	-
F6-35 and F6-36	-	-	-	-	x	-
F6-45 to F6-49	-	-	-	-	-	-
F6-50 to F6-71	-	-	-	-	-	-
F7-01 to F7-15	-	-	-	-	-	-
F7-16	-	-	-	-	-	-
F7-17 to F7-42	-	-	-	-	-	-
F7-60 to F7-79	-	-	-	x	-	-

**Table 11.54 Correspondence Between Communication Protocols and Parameters (SI-CB, SI-N3, SI-W3, SI-EM3, SI-EP3, and SI-EN3)**

Parameters	DeviceNet SI-N3	LonWorks SI-W3	Modbus TCP/IP SI-EM3	PROFINET SI-EP3	EtherNet/IP SI-EN3
F6-01 to F6-03	x	x	x	x	x
F6-04	-	-	-	-	-
F6-06 to F6-08	x	x	x	x	x
F6-10 and F6-11	-	-	-	-	-
F6-14	x	x	x	x	x
F6-16	x	x	x	x	x
F6-20 and F6-21	-	-	-	-	-
F6-22	-	-	-	-	-
F6-23 to F6-26	-	-	-	-	-
F6-30 to F6-32	-	-	-	-	-
F6-35 and F6-36	-	-	-	-	-
F6-45 to F6-49	-	-	-	-	-
F6-50 to F6-71	x	-	-	-	-
F7-01 to F7-15	-	-	x	x	x
F7-16	-	-	x	-	-
F7-17 to F7-42	-	-	-	x	x
F7-60 to F7-79	-	-	-	-	-



## ■ F6-01: Communication Error Selection

No. (Hex.)	Name	Description	Default (Range)
F6-01 (03A2)	Communication Error Selection	<div style="display: flex; justify-content: space-between; font-size: 0.8em; font-weight: bold; background-color: #f0f0f0; padding: 2px;"> <span>V/f</span> <span>CL-V/f</span> <span>OLV</span> <span>CLV</span> <span>AOLV</span> <span>OLV/PM</span> <span>AOLV/PM</span> <span>CLV/PM</span> <span>EZOLV</span> </div> Sets the method to stop the motor or let the motor continue operating when the drive detects a <i>bUS</i> [Option Communication Error].	1 (0 - 5)

### 0 : Ramp to Stop

The drive ramps to stop in the set deceleration time. Fault relay output terminal MA-MC activates and terminal MB-MC deactivates.

### 1 : Coast to Stop

The drive output shuts off and the motor coasts to stop. Fault relay output terminal MA-MC activates and terminal MB-MC deactivates.

### 2 : Fast Stop (Use C1-09)

The drive stops the motor in the deceleration time set in *C1-09* [Fast Stop Time]. Fault relay output terminal MA-MC activates and terminal MB-MC deactivates.

### 3 : Alarm Only

The keypad shows *bUS* and the drive continues operation at the current frequency reference.

#### Note:

Separately prepare safety protection equipment and systems, for example fast stop switches.

The output terminal set for *Alarm* [*H2-01 to H2-03 = 10*] activates.

### 4 : Alarm (Run at d1-04)

The keypad shows *bUS* and the drive continues operation at the speed set in *d1-04* [Reference 4].

#### Note:

Separately prepare safety protection equipment and systems, for example fast stop switches.

### 5 : Alarm - Ramp Stop

The drive stops the motor during the deceleration time set in *C1-02* [Deceleration Time 1].

After you remove the *bUS* alarm, the motor will accelerate to the previous frequency reference.

## ■ F6-02: Comm External Fault (EF0) Detect

No. (Hex.)	Name	Description	Default (Range)
F6-02 (03A3)	Comm External Fault (EF0) Detect	<div style="display: flex; justify-content: space-between; font-size: 0.8em; font-weight: bold; background-color: #f0f0f0; padding: 2px;"> <span>V/f</span> <span>CL-V/f</span> <span>OLV</span> <span>CLV</span> <span>AOLV</span> <span>OLV/PM</span> <span>AOLV/PM</span> <span>CLV/PM</span> <span>EZOLV</span> </div> Sets when the drive will detect <i>EF0</i> [Option Card External Fault] is detected.	0 (0, 1)

### 0 : Always Detected

### 1 : Detected during RUN Only

## ■ F6-03: Comm External Fault (EF0) Select

No. (Hex.)	Name	Description	Default (Range)
F6-03 (03A4)	Comm External Fault (EF0) Select	<div style="display: flex; justify-content: space-between; font-size: 0.8em; font-weight: bold; background-color: #f0f0f0; padding: 2px;"> <span>V/f</span> <span>CL-V/f</span> <span>OLV</span> <span>CLV</span> <span>AOLV</span> <span>OLV/PM</span> <span>AOLV/PM</span> <span>CLV/PM</span> <span>EZOLV</span> </div> Sets the method to stop the motor or let the motor continue operating when the drive detects an <i>EF0</i> [Option Card External Fault].	1 (0 - 3)

### 0 : Ramp to Stop

The drive ramps to stop in the set deceleration time. Fault relay output terminal MA-MC activates and terminal MB-MC deactivates.

### 1 : Coast to Stop

The drive output shuts off and the motor coasts to stop. Fault relay output terminal MA-MC activates and terminal MB-MC deactivates.

### 2 : Fast Stop (Use C1-09)

The drive stops the motor in the deceleration time set in *C1-09 [Fast Stop Time]*. Fault relay output terminal MA-MC activates and terminal MB-MC deactivates.

**3 : Alarm Only**

The keypad shows *EF0* and the drive continues operation at the current frequency reference.

**Note:**

Separately prepare safety protection equipment and systems, for example fast stop switches.

The output terminal set for *Alarm [H2-01 to H2-03 = 10]* activates.

**■ F6-04: bUS Error Detection Time**

No. (Hex.)	Name	Description	Default (Range)
F6-04 (03A5)	bUS Error Detection Time	<b>V/f</b> <b>CL-V/f</b> <b>OLV</b> <b>CLV</b> <b>AOLV</b> <b>OLV/PM</b> <b>AOLV/PM</b> <b>CLV/PM</b> <b>EZOLV</b> Sets the delay time for the drive to detect <i>bUS [Option Communication Error]</i> .	2.0 s (0.0 - 5.0 s)

**Note:**

When you install an option card in the drive, the parameter value changes to 0.0 s.

**■ F6-06: Torque Reference/Limit by Comm**

No. (Hex.)	Name	Description	Default (Range)
F6-06 (03A7)	Torque Reference/Limit by Comm	<b>V/f</b> <b>CL-V/f</b> <b>OLV</b> <b>CLV</b> <b>AOLV</b> <b>OLV/PM</b> <b>AOLV/PM</b> <b>CLV/PM</b> <b>EZOLV</b> Sets the function that enables and disables the torque reference and torque limit received from the communication option.	0 (0, 1)

**0 : Disabled**

**1 : Enabled**

**■ F6-07: Multi-Step Ref @ NetRef/ComRef**

No. (Hex.)	Name	Description	Default (Range)
F6-07 (03A8)	Multi-Step Ref @ NetRef/ComRef	<b>V/f</b> <b>CL-V/f</b> <b>OLV</b> <b>CLV</b> <b>AOLV</b> <b>OLV/PM</b> <b>AOLV/PM</b> <b>CLV/PM</b> <b>EZOLV</b> Sets the function that enables and disables the multi-step speed reference when the frequency reference source is NetRef or ComRef (communication option card or MEMOBUS/Modbus communications).	0 (0, 1)

**0 : Disable Multi-Step References**

When NetRef or ComRef are the frequency reference source, the multi-step speed reference (2-step speed to 16-step speed references) and the Jog Frequency Reference (JOG command) are disabled.

**1 : Enable Multi-Step References**

When NetRef or ComRef are the frequency reference source, the multi-step speed reference (2-step speed through 16-step speed references) and the Jog Frequency Reference (JOG command) are enabled, and you can change the frequency reference.

**■ F6-08: Comm Parameter Reset @Initialize**

No. (Hex.)	Name	Description	Default (Range)
F6-08 (036A)	Comm Parameter Reset @Initialize	<b>V/f</b> <b>CL-V/f</b> <b>OLV</b> <b>CLV</b> <b>AOLV</b> <b>OLV/PM</b> <b>AOLV/PM</b> <b>CLV/PM</b> <b>EZOLV</b> Sets the function to initialize <i>F6-xx</i> and <i>F7-xx</i> parameters when the drive is initialized with <i>A1-03 [Initialize Parameters]</i> .	0 (0, 1)

**0 : No Reset - Parameters Retained**

**1 : Reset Back to Factory Default**

**Note:**

When you use *A1-03* to initialize the drive, this setting will not change.

### ■ F6-10: CC-Link Node Address

No. (Hex.)	Name	Description	Default (Range)
F6-10 (03B6)	CC-Link Node Address	<b>V/f</b> <b>CL-V/f</b> <b>OLV</b> <b>CLV</b> <b>AOLV</b> <b>OLV/PM</b> <b>AOLV/PM</b> <b>CLV/PM</b> <b>EZOLV</b> Sets the node address for CC-Link communication. Restart the drive after changing this setting.	0 (0 - 64)

#### Note:

Be sure to set a node address that is different than all other node addresses. Do not set this parameter to 0. Incorrect parameter settings will cause *AER* [Station Address Setting Error] errors and the L.ERR LED on the option will come on.

When the only drive is connected, you can connect a maximum of 42 nodes. Follow these rules to connect devices that are not drives:

- $\{(1 \times a) + (2 \times b) + (3 \times c) + (4 \times d)\} \leq 64$   
(a: number of units that occupies 1 node, b: number of units that occupies 2 nodes, c: number of units that occupies 3 nodes, d: number of units that occupies 4 nodes)
- $\{(16 \times A) + (54 \times B) + (88 \times C)\} \leq 2304$   
(A: number of remote I/O nodes (64 max.), B: number of remote device nodes (42 max.), C: number of local nodes (26 max.))

### ■ F6-11: CC-Link Communication Speed

No. (Hex.)	Name	Description	Default (Range)
F6-11 (03B7)	CC-Link Communication Speed	<b>V/f</b> <b>CL-V/f</b> <b>OLV</b> <b>CLV</b> <b>AOLV</b> <b>OLV/PM</b> <b>AOLV/PM</b> <b>CLV/PM</b> <b>EZOLV</b> Sets the communication speed for CC-Link communication. Restart the drive after you change this setting.	0 (0 - 4)

**0 : 156 kbps**

**1 : 625 kbps**

**2 : 2.5 Mbps**

**3 : 5 Mbps**

**4 : 10 Mbps**

### ■ F6-14: BUS Error Auto Reset

No. (Hex.)	Name	Description	Default (Range)
F6-14 (03BB)	BUS Error Auto Reset	<b>V/f</b> <b>CL-V/f</b> <b>OLV</b> <b>CLV</b> <b>AOLV</b> <b>OLV/PM</b> <b>AOLV/PM</b> <b>CLV/PM</b> <b>EZOLV</b> Sets the automatic reset function for <i>bUS</i> [Option Communication Errors].	0 (0, 1)

**0 : Disabled**

**1 : Enabled**

### ■ F6-16: Gateway Mode

No. (Hex.)	Name	Description	Default (Range)
F6-16 (0B8A)	Gateway Mode	<b>V/f</b> <b>CL-V/f</b> <b>OLV</b> <b>CLV</b> <b>AOLV</b> <b>OLV/PM</b> <b>AOLV/PM</b> <b>CLV/PM</b> <b>EZOLV</b> Sets the gateway mode operation and the number of connected slave drives.	0 (0 - 4)

**0 : Disabled**

**1 : Enabled: 1 Slave Drive**

**2 : Enabled: 2 Slave Drives**

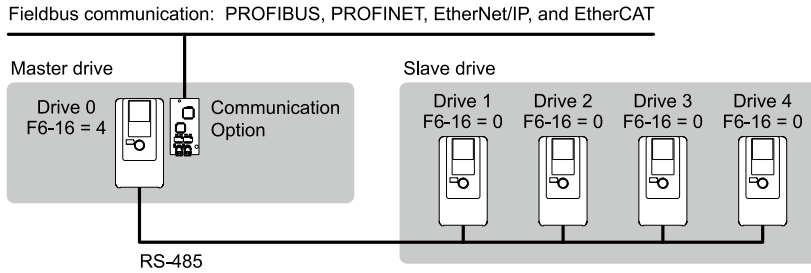
**3 : Enabled: 3 Slave Drives**

**4 : Enabled: 4 Slave Drives**

Gateway Mode processes communications through internal the RS-485 communication function to relay data from a drive that has the communication option to more than one drive that does not have the communication option. This function lets you use fieldbus communication to connect a maximum of 5 drives with only one

communication option. The drive sends these commands and responses between the controller (Host device), master drive (Drive 0), and the slave drives (Drive 1 to Drive 4).

- Commands: Run command and frequency reference
- Output frequency and drive status (during run, faults)
- Read and write parameters
- Read monitors



**NOTICE:** When you use Gateway Mode, do not install the communication option in slave drives. Failure to obey can cause problems with synchronization of drive commands and responses.

**Note:**

- Response speed with the communication option is slower than with point-to-point communications.
- Set H5-03 [Communication Parity Selection] to the same value on the master drive and slave drives.

Table 11.55 shows the parameter settings when you connect 4 slave drives:

**Table 11.55 Parameter Settings to Connect 4 Slave Drives**

	F6-16 [Gateway Mode]	H5-01 [Drive Node Address]	H5-02 [Communication Speed Selection]	H5-03 [Communication Parity Selection]	H5-06 [Drive Transmit Wait Time]	H5-09 [CE Detection Time]	b1-01 [Frequency Reference Selection 1]	b1-02 [Run Command Selection 1]
Drive0 (Master Drive)	1 - 4	1F (Default)	*2	*2	5 ms *3	2.0 s minimum *4	3 [Option PCB]	3 [Option PCB]
Drive1 (Slave Drive 1)	0	01	*2	*2	5 ms *3	0.9 s minimum *4	2 [MEMOBUS/Modbus Communications] *5	2 [MEMOBUS/Modbus Communications] *5
Drive2 (Slave Drive 2)	0	02	*2	*2	5 ms *3	0.9 s minimum *4	2 [MEMOBUS/Modbus Communications] *5	2 [MEMOBUS/Modbus Communications] *5
Drive3 (Slave Drive 3)	0	03	*2	*2	5 ms *3	0.9 s minimum *4	2 [MEMOBUS/Modbus Communications] *5	2 [MEMOBUS/Modbus Communications] *5
Drive4 (Slave Drive 4)	0	04	*2	*2	5 ms *3	0.9 s minimum *4	2 [MEMOBUS/Modbus Communications] *5	2 [MEMOBUS/Modbus Communications] *5

\*1 Set the number of connected slave drives.

\*2 Make sure that you set the communications speed and communications parity to the same value on the master drive and slave drives.

\*3 To correctly detect the response timeout, do not change the value of H5-06 from the default value.

\*4 Set H5-09 ≥ 0.9 s. When H5-09 < 0.9, the drive will detect CE before it detects a response timeout.

\*5 Set the Run command and frequency reference source on slave drives to MEMOBUS/Modbus communications.

**Note:**

- If the timeout or message occurs 10 consecutive times, the master drive stops transmitting to the slave drives. Reset the fault to restart communication.
- If you change the access command before the MEMOBUS/Modbus access completion flag turns on, the drive will not execute the command from before.

## Special Register Specifications

Table 11.56 Command Data

Register No.	Description		
1	Command source update (15C5H)		
	bit 0	Drive 1 Update Command Enabled	
	bit 1	Drive 2 Update Command Enabled	
	bit 2	Drive 3 Update Command Enabled	
	bit 3	Drive 4 Update Command Enabled	
	bit 4	Update Register Access Command Enabled	
	bit 5 - F	Reserved	
2	Run Command (Drive 1) (15C6H)		
	bit 0	H5-12 = 0: FWD/Stop 0 = Stop 1 = Forward run	
		H5-12 = 1: Run/Stop 0 = Stop 1 = Run	
	bit 1	H5-12 = 0: REV/Stop 0 = Stop 1 = Reverse run	
		H5-12 = 1: FWD/REV 0 = Forward run 1 = Reverse run	
	bit 2	External Fault	
	bit 3	Fault Reset	
	bit 4	ComRef	
bit 5	ComCtrl		
bit 6 - F	Reserved		
3	Frequency Reference (Drive 1) (15C7H)		
4	Run Command (Drive 2) (15C8H)		
5	Frequency Reference (Drive 2) (15C9H)		
6	Run Command (Drive 3) (15CAH)		
7	Frequency Reference (Drive 3) (15CBH)		
8	Run Command (Drive 4) (15CCH)		
9	Frequency Reference (Drive 4) (15CDH)		
10	Slave Address for Reg. Access + Read/Write (15CEH)		
	bit 0 bit 1 bit 2 bit 3 bit 4 bit 5 - F	Slave address 0: Broadcast Messages (MEMOBUS) 1: Drive 1 2: Drive 2 3: Drive 3 4: Drive 4 5: Broadcast Messages (run command and frequency reference)	
		0: Read, 1: Write	
		Reserved	
		When bit 0 to 3 = 0, access is enabled for broadcast messages only. When bit 0 to 3 = 5, access is enabled for Run command and frequency reference broadcast messages only. Drive 0 is excluded.	

## 11.7 F: Options

Register No.	Description
11	Register number (15CFH)
12	Data (write register) (15D0H)

**Table 11.57 Monitor Data**

Register No.	Description	
1	Command source update (15E7H)	
	bit 0 During Run	
	bit 1 During Reverse Run	
	bit 2 Drive Ready	
	bit 3 Fault	
	bit 4 Frequency Command Setting Fault	1: Upper/Lower Limit Fault
	bit 5 No response from slave	1: Response has timed out.
	bit 6 Communication Error	1: A fault has been detected from a slave.
	bit 7 No response from slave 10 consecutive attempts.	1: Timeout has occurred 10 consecutive times.
	bit 8 Communication fault has occurred 10 consecutive times.	1: Fault has occurred from a slave 10 consecutive times.
	bit 9 Receive broadcast command while drive is running	1: Drive operates in as specified by the broadcast message command.
	bit A Communication error with master drive	1: The slave cannot communicate with the master because of a communication error.
	bit B - D Reserved	
	bit E ComRef status	
bit F ComCtrl status		
2	Output frequency or frequency reference (Drive Status Bit 4: ON) (Drive 1) (15E8) Drive Status Bit 4 = 0 [Output Frequency] Drive Status Bit 4 = 1 [Frequency Reference]	The unit of measure changes when <i>o1-03</i> changes.
3	Drive Status (Drive 2) (15E9H)	
4	Output frequency or frequency reference (Drive Status Bit 4: ON) (Drive 2) (15EAH)	
5	Drive Status (Drive 3) (15EBH)	
6	Output frequency or frequency reference (Drive Status Bit 4: ON) (Drive 3) (15ECH)	
7	Drive Status (Drive 4) (15EDH)	
8	Output frequency or frequency reference (Drive Status Bit 4: ON) (Drive 4) (15EEH)	

Register No.	Description	
9	Slave Address for Reg. Access + During MEMOBUS process & ErrCode (15EFH)	
	bit 0	00H: MEMOBUS/Modbus Communication Complete
	bit 1	02H: Register number not registered
	bit 2	21H: Upper/Lower Limit Fault
	bit 3	22H: Write Mode Error
	bit 4	23H: Write performed during occurrence of <i>U<sub>v</sub></i>
	bit 5	24H: Write performed while writing parameter settings
	bit 6	FFH: During MEMOBUS/Modbus Communication
	bit 7	
	bit 8	Slave address 0: MEMOBUS command ignored
	bit 9	1: Drive 1
	bit A	2: Drive 2 4: Drive 3 5: Drive 4
11	Register number (15F0H)	
12	Data (write register) (15F1H)	

### ■ F6-20: MECHATROLINK Station Address

No. (Hex.)	Name	Description	Default (Range)
F6-20 (036B)	MECHATROLINK Station Address	<div style="display: flex; justify-content: space-between; font-size: small;"> <span>V/f</span> <span>CL-V/f</span> <span>OLV</span> <span>CLV</span> <span>AOLV</span> <span>OLV/PM</span> <span>AOLV/PM</span> <span>CLV/PM</span> <span>EZOLV</span> </div> Sets the station address for MECHATROLINK communication. Restart the drive after changing this setting.	0021h (MECHATROLINK-II : 0020h - 003Fh , MECHATROLINK-III : 0003h - 00EFh)

**Note:**

- The setting range changes if using MECHATROLINK-II or MECHATROLINK-III:  
 –MECHATROLINK-II (SI-T3) range: 20 to 3F  
 –MECHATROLINK-III (SI-ET3) range: 03 to EF
- Be sure to set a node address that is different than all other node addresses. Incorrect parameter settings will cause *AEr [Station Address Setting Error]* errors and the L.ERR LED on the option will come on.
- The drive detects *AEr* errors when the station address is 20 or 3F.

### ■ F6-21: MECHATROLINK Frame Size

No. (Hex.)	Name	Description	Default (Range)
F6-21 (036C)	MECHATROLINK Frame Size	<div style="display: flex; justify-content: space-between; font-size: small;"> <span>V/f</span> <span>CL-V/f</span> <span>OLV</span> <span>CLV</span> <span>AOLV</span> <span>OLV/PM</span> <span>AOLV/PM</span> <span>CLV/PM</span> <span>EZOLV</span> </div> Sets the frame size for MECHATROLINK communication. Restart the drive after you change this setting.	0 (0, 1)

**0 : 32byte (M-2) / 64byte (M-3)**

**1 : 17byte (M-2) / 32byte (M-3)**

### ■ F6-22: MECHATROLINK Link Speed

No. (Hex.)	Name	Description	Default (Range)
F6-22 (036D)	MECHATROLINK Link Speed	<div style="display: flex; justify-content: space-between; font-size: small;"> <span>V/f</span> <span>CL-V/f</span> <span>OLV</span> <span>CLV</span> <span>AOLV</span> <span>OLV/PM</span> <span>AOLV/PM</span> <span>CLV/PM</span> <span>EZOLV</span> </div> Sets the communications speed for MECHATROLINK-II. Restart the drive after you change this setting.	0 (0, 1)

**Note:**

This parameter is only available with the MECHATROLINK-II option.

**0 : 10 Mbps**

**1 : 4 Mbps****■ F6-23: MECHATROLINK Monitor Select (E)**

No. (Hex.)	Name	Description	Default (Range)
F6-23 (036E)	MECHATROLINK Monitor Select (E)	<b>V/f</b> <b>CL-V/f</b> <b>OLV</b> <b>CLV</b> <b>AOLV</b> <b>OLV/PM</b> <b>AOLV/PM</b> <b>CLV/PM</b> <b>EZOLV</b> Sets the MEMOBUS register used for the monitor functions of INV_CTL (drive operation control command) and INV_I/O (drive I/O control command). Restart the drive after you change this setting.	0000h (0000h - FFFFh)

To enable the MEMOBUS register set in *F6-23*, set SEL\_MON2/1 to 0EH or set SEL\_MON 3/4 and SEL\_MON 5/6 to 0EH. Bytes of the response data enable the MEMOBUS register content that was set in *F6-23*.

**■ F6-24: MECHATROLINK Monitor Select (F)**

No. (Hex.)	Name	Description	Default (Range)
F6-24 (036F)	MECHATROLINK Monitor Select (F)	<b>V/f</b> <b>CL-V/f</b> <b>OLV</b> <b>CLV</b> <b>AOLV</b> <b>OLV/PM</b> <b>AOLV/PM</b> <b>CLV/PM</b> <b>EZOLV</b> Sets the MEMOBUS register used for the monitor functions of INV_CTL (drive operation control command) and INV_I/O (drive I/O control command). Restart the drive after you change this setting.	0000h (0000h - FFFFh)

To enable the MEMOBUS register set in *F6-24*, set SEL\_MON2/1 to 0FH or set SEL\_MON3/4 and SEL\_MON 5/6 to 0FH. Bytes of the response data enable the MEMOBUS register content that was set *F6-24*.

**■ F6-25: MECHATROLINK Watchdog Error Sel**

No. (Hex.)	Name	Description	Default (Range)
F6-25 (03C9)	MECHATROLINK Watchdog Error Sel	<b>V/f</b> <b>CL-V/f</b> <b>OLV</b> <b>CLV</b> <b>AOLV</b> <b>OLV/PM</b> <b>AOLV/PM</b> <b>CLV/PM</b> <b>EZOLV</b> Sets the method to stop the motor or let the motor continue operating when the drive detects an <i>E5</i> [ <i>MECHATROLINK Watchdog Timer Err</i> ].	1 (0 - 3)

**0 : Ramp to Stop**

The drive ramps to stop in the set deceleration time. Fault relay output terminal MA-MC will activate, and MB-MC will deactivate.

**1 : Coast to Stop**

The drive output shuts off and the motor coasts to stop. Fault relay output terminal MA-MC will activate, and MB-MC will deactivate.

**2 : Fast Stop (Use C1-09)**

The drive uses the deceleration time set in *C1-09* [*Fast Stop Time*]. Fault relay output terminal MA-MC will activate, and MB-MC will deactivate.

**3 : Alarm Only**

The keypad shows *E5*, and the drive continues to operate.

**Note:**

Separately prepare safety protection equipment and systems, for example fast stop switches.

The output terminal set for *Alarm* [*H2-01 to H2-03 = 10*] activates.

**■ F6-26: MECHATROLINK Allowable No of Err**

No. (Hex.)	Name	Description	Default (Range)
F6-26 (03CA)	MECHATROLINK Allowable No of Err	<b>V/f</b> <b>CL-V/f</b> <b>OLV</b> <b>CLV</b> <b>AOLV</b> <b>OLV/PM</b> <b>AOLV/PM</b> <b>CLV/PM</b> <b>EZOLV</b> Sets the number of times that the option must detect a <i>bUS</i> alarm to cause a <i>bUS</i> [ <i>Option Communication Error</i> ].	2 times (2 - 10 times)



### ■ F6-30: PROFIBUS-DP Node Address

No. (Hex.)	Name	Description	Default (Range)
F6-30 (03CB)	PROFIBUS-DP Node Address	<b>V/f</b> <b>CL-V/f</b> <b>OLV</b> <b>CLV</b> <b>AOLV</b> <b>OLV/PM</b> <b>AOLV/PM</b> <b>CLV/PM</b> <b>EZOLV</b> Sets the node address for PROFIBUS-DP communication. Restart the drive after changing this setting.	0 (0 - 125)

**Note:**

- Be sure to set a node address that is different than all other node addresses.
- Node addresses 0, 1, and 2 are usually reserved for control, maintenance, and device self-diagnosis.

### ■ F6-31: PROFIBUS-DP Clear Mode Selection

No. (Hex.)	Name	Description	Default (Range)
F6-31 (03CC)	PROFIBUS-DP Clear Mode Selection	<b>V/f</b> <b>CL-V/f</b> <b>OLV</b> <b>CLV</b> <b>AOLV</b> <b>OLV/PM</b> <b>AOLV/PM</b> <b>CLV/PM</b> <b>EZOLV</b> Sets what the drive will do after it receives the Clear Mode command.	0 (0, 1)

#### 0 : Reset

Resets drive settings, for example frequency reference and I/O settings.

#### 1 : Hold Previous State

The drive keeps the same status as before it received the command.

### ■ F6-32: PROFIBUS-DP Data Format Select

No. (Hex.)	Name	Description	Default (Range)
F6-32 (03CD)	PROFIBUS-DP Data Format Select	<b>V/f</b> <b>CL-V/f</b> <b>OLV</b> <b>CLV</b> <b>AOLV</b> <b>OLV/PM</b> <b>AOLV/PM</b> <b>CLV/PM</b> <b>EZOLV</b> Sets the data format of PROFIBUS-DP communication. Restart the drive after changing this setting.	0 (0 - 5)

**Note:**

The *H5-11 [Comm ENTER Command Mode]* setting makes the RAM enter command necessary or not necessary to write parameters over network communication. When *F6-32 = 0, 1, or 2*, the *H5-11* setting does not have an effect. The RAM enter command is always necessary to write parameters.

#### 0 : PPO Type

#### 1 : Conventional

#### 2 : PPO (bit0)

This function operates when bit 0 and bit 4 in the register STW have values of 1 (operate). Refer to the PROFIBUS-DP communication manual for more information.

#### 3 : PPO (Enter)

#### 4 : Conventional (Enter)

#### 5 : PPO (bit0, Enter)

This function operates when bit 0 and bit 4 in the register STW have values of 1 (operate). Refer to the PROFIBUS-DP communication manual for more information.

### ■ F6-35: CANopen Node ID Selection

No. (Hex.)	Name	Description	Default (Range)
F6-35 (03D0)	CANopen Node ID Selection	<b>V/f</b> <b>CL-V/f</b> <b>OLV</b> <b>CLV</b> <b>AOLV</b> <b>OLV/PM</b> <b>AOLV/PM</b> <b>CLV/PM</b> <b>EZOLV</b> Sets the node address for CANopen communication. Restart the drive after changing this setting.	0 (0 - 126)

**Note:**

Be sure to set an address that is different than all other node addresses. Do not set this parameter to 0. Incorrect parameter settings will cause *Aer [Station Address Setting Error]* errors and the L.ERR LED on the option will come on.

### ■ F6-36: CANopen Communication Speed

No. (Hex.)	Name	Description	Default (Range)
F6-36 (03D1)	CANopen Communication Speed	<b>V/f</b> <b>CL-V/f</b> <b>OLV</b> <b>CLV</b> <b>AOLV</b> <b>OLV/PM</b> <b>AOLV/PM</b> <b>CLV/PM</b> <b>EZOLV</b> Sets the CANopen communications speed. Restart the drive after you change this setting.	0 (0 - 8)

#### 0 : Auto-detection

The drive detects the network communication speed and automatically adjusts the communications speed.

1 : 10 kbps

2 : 20 kbps

3 : 50 kbps

4 : 125 kbps

5 : 250 kbps

6 : 500 kbps

7 : 800 kbps

8 : 1 Mbps

### ■ F6-45: BACnet Node Address

No. (Hex.)	Name	Description	Default (Range)
F6-45 (02FB)	BACnet Node Address	<b>V/f</b> <b>CL-V/f</b> <b>OLV</b> <b>CLV</b> <b>AOLV</b> <b>OLV/PM</b> <b>AOLV/PM</b> <b>CLV/PM</b> <b>EZOLV</b> Sets the node address for BACnet communication.	1 (0 - 127)

### ■ F6-46: BACnet Baud Rate

No. (Hex.)	Name	Description	Default (Range)
F6-46 (02FC)	BACnet Baud Rate	<b>V/f</b> <b>CL-V/f</b> <b>OLV</b> <b>CLV</b> <b>AOLV</b> <b>OLV/PM</b> <b>AOLV/PM</b> <b>CLV/PM</b> <b>EZOLV</b> Sets the BACnet communications speed.	3 (0 - 8)

0 : 1200 bps

1 : 2400 bps

2 : 4800 bps

3 : 9600 bps

4 : 19.2 kbps

5 : 38.4 kbps

6 : 57.6 kbps

7 : 76.8 kbps

8 : 115.2 kbps

### ■ F6-47: Rx to Tx Wait Time

No. (Hex.)	Name	Description	Default (Range)
F6-47 (02FD)	Rx to Tx Wait Time	<b>V/f</b> <b>CL-V/f</b> <b>OLV</b> <b>CLV</b> <b>AOLV</b> <b>OLV/PM</b> <b>AOLV/PM</b> <b>CLV/PM</b> <b>EZOLV</b> Sets the wait time for the drive to receive and send BACnet communication.	5 ms (5 - 65 ms)

### ■ F6-48: BACnet Device Object Identifier0

No. (Hex.)	Name	Description	Default (Range)
F6-48 (02FE)	BACnet Device Object Identifier0	<b>V/f</b> <b>CL-V/f</b> <b>OLV</b> <b>CLV</b> <b>AOLV</b> <b>OLV/PM</b> <b>AOLV/PM</b> <b>CLV/PM</b> <b>EZOLV</b> Sets the last word of BACnet communication addresses.	0 (0 - FFFF)

### ■ F6-49: BACnet Device Object Identifier1

No. (Hex.)	Name	Description	Default (Range)
F6-49 (02FF)	BACnet Device Object Identifier1	<b>V/f</b> <b>CL-V/f</b> <b>OLV</b> <b>CLV</b> <b>AOLV</b> <b>OLV/PM</b> <b>AOLV/PM</b> <b>CLV/PM</b> <b>EZOLV</b> Sets the last word of BACnet communication addresses.	0 (0 - 3F)

### ■ F6-50: DeviceNet MAC Address

No. (Hex.)	Name	Description	Default (Range)
F6-50 (03C1)	DeviceNet MAC Address	<b>V/f</b> <b>CL-V/f</b> <b>OLV</b> <b>CLV</b> <b>AOLV</b> <b>OLV/PM</b> <b>AOLV/PM</b> <b>CLV/PM</b> <b>EZOLV</b> Sets the MAC address for DeviceNet communication. Restart the drive after you change this setting.	0 (0 - 64)

**Note:**

Be sure to set a MAC address that is different than all other node addresses. Do not set this parameter to 0. Incorrect parameter settings will cause *AEr* [Station Address Setting Error] errors and the MS LED on the option will flash.

### ■ F6-51: DeviceNet Baud Rate

No. (Hex.)	Name	Description	Default (Range)
F6-51 (03C2)	DeviceNet Baud Rate	<b>V/f</b> <b>CL-V/f</b> <b>OLV</b> <b>CLV</b> <b>AOLV</b> <b>OLV/PM</b> <b>AOLV/PM</b> <b>CLV/PM</b> <b>EZOLV</b> Sets the DeviceNet communications speed. Restart the drive after you change this setting.	0 (0 - 4)

**0 : 125 kbps**

**1 : 250 kbps**

**2 : 500 kbps**

**3 : Adjustable from Network**

The controller sets the communications speed.

**4 : Detect Automatically**

The drive detects the network communication speed and automatically adjusts the communications speed.

### ■ F6-52: DeviceNet PCA Setting

No. (Hex.)	Name	Description	Default (Range)
F6-52 (03C3)	DeviceNet PCA Setting	<b>V/f</b> <b>CL-V/f</b> <b>OLV</b> <b>CLV</b> <b>AOLV</b> <b>OLV/PM</b> <b>AOLV/PM</b> <b>CLV/PM</b> <b>EZOLV</b> Sets the format of data that the DeviceNet communication master sends to the drive.	21 (0 - 255)

**Note:**

If F6-52 [DeviceNet PCA Setting] and F6-53 [DeviceNet PPA Setting] are not correct, the value is reset to default.

### ■ F6-53: DeviceNet PPA Setting

No. (Hex.)	Name	Description	Default (Range)
F6-53 (03C4)	DeviceNet PPA Setting	<b>V/f</b> <b>CL-V/f</b> <b>OLV</b> <b>CLV</b> <b>AOLV</b> <b>OLV/PM</b> <b>AOLV/PM</b> <b>CLV/PM</b> <b>EZOLV</b> Sets the format of data that the drive sends to the DeviceNet communication master.	71 (0 - 255)

**Note:**

If F6-52 [DeviceNet PCA Setting] and F6-53 [DeviceNet PPA Setting] are not correct, the value is reset to default.

### ■ F6-54: DeviceNet Idle Fault Detection

No. (Hex.)	Name	Description	Default (Range)
F6-54 (03C5)	DeviceNet Idle Fault Detection	<b>V/f</b> <b>CL-V/f</b> <b>OLV</b> <b>CLV</b> <b>AOLV</b> <b>OLV/PM</b> <b>AOLV/PM</b> <b>CLV/PM</b> <b>EZOLV</b> Sets the function to detect <i>EF0</i> [Option Card External Fault] when the drive does not receive data from the DeviceNet master.	0 (0 - 4)

**0 : Enabled**

**1 : Disabled, No Fault Detection**

Does not detect *EF0* issues.

**2 : Vendor Specific**

**3 : RUN Forward**

**4 : RUN Reverse**

### ■ F6-55: DeviceNet Baud Rate Monitor

No. (Hex.)	Name	Description	Default (Range)
F6-55 (03C6)	DeviceNet Baud Rate Monitor	<b>V/f</b> <b>CL-V/f</b> <b>OLV</b> <b>CLV</b> <b>AOLV</b> <b>OLV/PM</b> <b>AOLV/PM</b> <b>CLV/PM</b> <b>EZOLV</b> Sets the function to see the actual DeviceNet communications speed using the keypad. This parameter functions as a monitor only.	0 (0 - 2)

**0 : 125 kbps**

**1 : 250 kbps**

**2 : 500 kbps**

### ■ F6-56: DeviceNet Speed Scaling

No. (Hex.)	Name	Description	Default (Range)
F6-56 (03D7)	DeviceNet Speed Scaling	<b>V/f</b> <b>CL-V/f</b> <b>OLV</b> <b>CLV</b> <b>AOLV</b> <b>OLV/PM</b> <b>AOLV/PM</b> <b>CLV/PM</b> <b>EZOLV</b> Sets the speed scale for DeviceNet communication.	0 (-15 - +15)

### ■ F6-57: DeviceNet Current Scaling

No. (Hex.)	Name	Description	Default (Range)
F6-57 (03D8)	DeviceNet Current Scaling	<b>V/f</b> <b>CL-V/f</b> <b>OLV</b> <b>CLV</b> <b>AOLV</b> <b>OLV/PM</b> <b>AOLV/PM</b> <b>CLV/PM</b> <b>EZOLV</b> Sets the current scale of the DeviceNet communication master.	0 (-15 - +15)

### ■ F6-58: DeviceNet Torque Scaling

No. (Hex.)	Name	Description	Default (Range)
F6-58 (03D9)	DeviceNet Torque Scaling	<b>V/f</b> <b>CL-V/f</b> <b>OLV</b> <b>CLV</b> <b>AOLV</b> <b>OLV/PM</b> <b>AOLV/PM</b> <b>CLV/PM</b> <b>EZOLV</b> Sets the torque scale of the DeviceNet communication master.	0 (-15 - +15)

### ■ F6-59: DeviceNet Power Scaling

No. (Hex.)	Name	Description	Default (Range)
F6-59 (03DA)	DeviceNet Power Scaling	<b>V/f</b> <b>CL-V/f</b> <b>OLV</b> <b>CLV</b> <b>AOLV</b> <b>OLV/PM</b> <b>AOLV/PM</b> <b>CLV/PM</b> <b>EZOLV</b> Sets the power scale of the DeviceNet communication master.	0 (-15 - +15)

### ■ F6-60: DeviceNet Voltage Scaling

No. (Hex.)	Name	Description	Default (Range)
F6-60 (03DB)	DeviceNet Voltage Scaling	<b>V/f</b> <b>CL-V/f</b> <b>OLV</b> <b>CLV</b> <b>AOLV</b> <b>OLV/PM</b> <b>AOLV/PM</b> <b>CLV/PM</b> <b>EZOLV</b> Sets the voltage scale of the DeviceNet communication master.	0 (-15 - +15)

### ■ F6-61: DeviceNet Time Scaling

No. (Hex.)	Name	Description	Default (Range)
F6-61 (03DC)	DeviceNet Time Scaling	<b>V/f</b> <b>CL-V/f</b> <b>OLV</b> <b>CLV</b> <b>AOLV</b> <b>OLV/PM</b> <b>AOLV/PM</b> <b>CLV/PM</b> <b>EZOLV</b> Sets the time scale of the DeviceNet communication master.	0 (-15 - +15)

### ■ F6-62: DeviceNet Heartbeat Interval

No. (Hex.)	Name	Description	Default (Range)
F6-62 (03DD)	DeviceNet Heartbeat Interval	<b>V/f</b> <b>CL-V/f</b> <b>OLV</b> <b>CLV</b> <b>AOLV</b> <b>OLV/PM</b> <b>AOLV/PM</b> <b>CLV/PM</b> <b>EZOLV</b> Sets the heartbeat for DeviceNet communication. Set this parameter to 0 to disable the heartbeat function.	0 (0 - 10)

### ■ F6-63: DeviceNet Network MAC ID

No. (Hex.)	Name	Description	Default (Range)
F6-63 (03DE)	DeviceNet Network MAC ID	<b>V/f</b> <b>CL-V/f</b> <b>OLV</b> <b>CLV</b> <b>AOLV</b> <b>OLV/PM</b> <b>AOLV/PM</b> <b>CLV/PM</b> <b>EZOLV</b> Sets the function to see the actual DeviceNet MAC address using the keypad. This parameter functions as a monitor only.	0 (0 - 63)

### ■ F6-64 to F6-67: Dynamic Out Assembly 109 Param1 to 4

No. (Hex.)	Name	Description	Default (Range)
F6-64 to F6-67 (03DF - 03E2)	Dynamic Out Assembly 109 Param 1 to 4	<b>V/f</b> <b>CL-V/f</b> <b>OLV</b> <b>CLV</b> <b>AOLV</b> <b>OLV/PM</b> <b>AOLV/PM</b> <b>CLV/PM</b> <b>EZOLV</b> Sets Configurable Outputs 1 to 4 written to the MEMOBUS register.	0000h (0000h - FFFFh)

### ■ F6-68 to F6-71: Dynamic In Assembly 159 Param 1 to 4

No. (Hex.)	Name	Description	Default (Range)
F6-68 to F6-71 (03E3, 03E4, 03C7, and 03C8)	Dynamic In Assembly 159 Param 1 to 4	<b>V/f</b> <b>CL-V/f</b> <b>OLV</b> <b>CLV</b> <b>AOLV</b> <b>OLV/PM</b> <b>AOLV/PM</b> <b>CLV/PM</b> <b>EZOLV</b> Sets Configurable Inputs 1 to 4 written to the MEMOBUS register.	0000h (0000h - FFFFh)

### ■ F6-72: PowerLink Node Address

No. (Hex.)	Name	Description	Default (Range)
F6-72 (081B)	PowerLink Node Address	<b>V/f</b> <b>CL-V/f</b> <b>OLV</b> <b>CLV</b> <b>AOLV</b> <b>OLV/PM</b> <b>AOLV/PM</b> <b>CLV/PM</b> <b>EZOLV</b> Sets the node ID for PowerLink communication.	0 (0 - 255)

### ■ F7-01: IP Address 1

No. (Hex.)	Name	Description	Default (Range)
F7-01 (03E5)	IP Address 1	<div style="display: flex; justify-content: space-between; font-size: 0.8em; font-weight: bold; margin-bottom: 5px;"> <span>V/f</span> <span>CL-V/f</span> <span>OLV</span> <span>CLV</span> <span>AOLV</span> <span>OLV/PM</span> <span>AOLV/PM</span> <span>CLV/PM</span> <span>EZOLV</span> </div> Sets the first octet of the IP Address for the device that is connecting to the network. Restart the drive after you change this parameter.	192 (0 - 255)

**Note:**

When  $F7-13 = 0$  [Address Mode at Startup = Static]:

- Use parameters  $F7-01$  to  $F7-04$  [IP Address 4] to set the IP Address. Be sure to set a different IP address for each drive on the network.
- Also set parameters  $F7-01$  to  $F7-12$ .

### ■ F7-02: IP Address 2

No. (Hex.)	Name	Description	Default (Range)
F7-02 (03E6)	IP Address 2	<div style="display: flex; justify-content: space-between; font-size: 0.8em; font-weight: bold; margin-bottom: 5px;"> <span>V/f</span> <span>CL-V/f</span> <span>OLV</span> <span>CLV</span> <span>AOLV</span> <span>OLV/PM</span> <span>AOLV/PM</span> <span>CLV/PM</span> <span>EZOLV</span> </div> Sets the second octet of the IP Address for the device that is connecting to the network. Restart the drive after you change this parameter.	168 (0 - 255)

**Note:**

When  $F7-13 = 0$  [Address Mode at Startup = Static]:

- Use parameters  $F7-01$  to  $F7-04$  [IP Address 4] to set the IP Address. Be sure to set a different IP address for each drive on the network.
- Also set parameters  $F7-01$  to  $F7-12$ .

### ■ F7-03: IP Address 3

No. (Hex.)	Name	Description	Default (Range)
F7-03 (03E7)	IP Address 3	<div style="display: flex; justify-content: space-between; font-size: 0.8em; font-weight: bold; margin-bottom: 5px;"> <span>V/f</span> <span>CL-V/f</span> <span>OLV</span> <span>CLV</span> <span>AOLV</span> <span>OLV/PM</span> <span>AOLV/PM</span> <span>CLV/PM</span> <span>EZOLV</span> </div> Sets the third octet of the IP Address for the device that is connecting to the network. Restart the drive after you change this parameter.	1 (0 - 255)

**Note:**

When  $F7-13 = 0$  [Address Mode at Startup = Static]:

- Use parameters  $F7-01$  to  $F7-04$  [IP Address 4] to set the IP Address. Be sure to set a different IP address for each drive on the network.
- Also set parameters  $F7-01$  to  $F7-12$ .

### ■ F7-04: IP Address 4

No. (Hex.)	Name	Description	Default (Range)
F7-04 (03E8)	IP Address 4	<div style="display: flex; justify-content: space-between; font-size: 0.8em; font-weight: bold; margin-bottom: 5px;"> <span>V/f</span> <span>CL-V/f</span> <span>OLV</span> <span>CLV</span> <span>AOLV</span> <span>OLV/PM</span> <span>AOLV/PM</span> <span>CLV/PM</span> <span>EZOLV</span> </div> Sets the fourth octet of the IP Address for the device that is connecting to the network. Restart the drive after you change this parameter.	20 (0 - 255)

**Note:**

When  $F7-13 = 0$  [Address Mode at Startup = Static]:

- Use parameters  $F7-01$  to  $F7-04$  [IP Address 4] to set the IP Address. Be sure to set a different IP address for each drive on the network.
- Also set parameters  $F7-01$  to  $F7-12$ .

### ■ F7-05: Subnet Mask 1

No. (Hex.)	Name	Description	Default (Range)
F7-05 (03E9)	Subnet Mask 1	<div style="display: flex; justify-content: space-between; font-size: 0.8em; font-weight: bold; margin-bottom: 5px;"> <span>V/f</span> <span>CL-V/f</span> <span>OLV</span> <span>CLV</span> <span>AOLV</span> <span>OLV/PM</span> <span>AOLV/PM</span> <span>CLV/PM</span> <span>EZOLV</span> </div> Sets the first octet of the subnet mask of the connected network.	255 (0 - 255)

**Note:**

Set this parameter when  $F7-13 = 0$  [Address Mode at Startup = Static].

### ■ F7-06: Subnet Mask 2

No. (Hex.)	Name	Description	Default (Range)
F7-06 (03EA)	Subnet Mask 2	<b>V/f</b> <b>CL-V/f</b> <b>OLV</b> <b>CLV</b> <b>AOLV</b> <b>OLV/PM</b> <b>AOLV/PM</b> <b>CLV/PM</b> <b>EZOLV</b> Sets the second octet of the subnet mask of the connected network.	255 (0 - 255)

**Note:**

Set this parameter when  $F7-13 = 0$  [Address Mode at Startup = Static].

### ■ F7-07: Subnet Mask 3

No. (Hex.)	Name	Description	Default (Range)
F7-07 (03EB)	Subnet Mask 3	<b>V/f</b> <b>CL-V/f</b> <b>OLV</b> <b>CLV</b> <b>AOLV</b> <b>OLV/PM</b> <b>AOLV/PM</b> <b>CLV/PM</b> <b>EZOLV</b> Sets the third octet of the subnet mask of the connected network.	255 (0 - 255)

**Note:**

Set this parameter when  $F7-13 = 0$  [Address Mode at Startup = Static].

### ■ F7-08: Subnet Mask 4

No. (Hex.)	Name	Description	Default (Range)
F7-08 (03EC)	Subnet Mask 4	<b>V/f</b> <b>CL-V/f</b> <b>OLV</b> <b>CLV</b> <b>AOLV</b> <b>OLV/PM</b> <b>AOLV/PM</b> <b>CLV/PM</b> <b>EZOLV</b> Sets the fourth octet of the subnet mask of the connected network.	0 (0 - 255)

**Note:**

Set this parameter when  $F7-13 = 0$  [Address Mode at Startup = Static].

### ■ F7-09: Gateway Address 1

No. (Hex.)	Name	Description	Default (Range)
F7-09 (03ED)	Gateway Address 1	<b>V/f</b> <b>CL-V/f</b> <b>OLV</b> <b>CLV</b> <b>AOLV</b> <b>OLV/PM</b> <b>AOLV/PM</b> <b>CLV/PM</b> <b>EZOLV</b> Sets the first octet of the gateway address of the connected network.	192 (0 - 255)

**Note:**

Set this parameter when  $F7-13 = 0$  [Address Mode at Startup = Static].

### ■ F7-10: Gateway Address 2

No. (Hex.)	Name	Description	Default (Range)
F7-10 (03EE)	Gateway Address 2	<b>V/f</b> <b>CL-V/f</b> <b>OLV</b> <b>CLV</b> <b>AOLV</b> <b>OLV/PM</b> <b>AOLV/PM</b> <b>CLV/PM</b> <b>EZOLV</b> Sets the second octet of the gateway address of the connected network.	168 (0 - 255)

**Note:**

Set this parameter when  $F7-13 = 0$  [Address Mode at Startup = Static].

### ■ F7-11: Gateway Address 3

No. (Hex.)	Name	Description	Default (Range)
F7-11 (03EF)	Gateway Address 3	<b>V/f</b> <b>CL-V/f</b> <b>OLV</b> <b>CLV</b> <b>AOLV</b> <b>OLV/PM</b> <b>AOLV/PM</b> <b>CLV/PM</b> <b>EZOLV</b> Sets the third octet of the gateway address of the connected network.	1 (0 - 255)

**Note:**

Set this parameter when  $F7-13 = 0$  [Address Mode at Startup = Static].

■ **F7-12: Gateway Address 4**

No. (Hex.)	Name	Description	Default (Range)
F7-12 (03F0)	Gateway Address 4	<b>V/f</b> <b>CL-V/f</b> <b>OLV</b> <b>CLV</b> <b>AOLV</b> <b>OLV/PM</b> <b>AOLV/PM</b> <b>CLV/PM</b> <b>EZOLV</b> Sets the fourth octet of the gateway address of the connected network.	1 (0 - 255)

**Note:**

Set this parameter when *F7-13 = 0* [Address Mode at Startup = Static].

■ **F7-13: Address Mode at Startup**

No. (Hex.)	Name	Description	Default (Range)
F7-13 (03F1)	Address Mode at Startup	<b>V/f</b> <b>CL-V/f</b> <b>OLV</b> <b>CLV</b> <b>AOLV</b> <b>OLV/PM</b> <b>AOLV/PM</b> <b>CLV/PM</b> <b>EZOLV</b> Sets the method to set option card IP addresses.	2 (0 - 2)

**0 : Static**

**1 : BOOTP**

**2 : DHCP**

**Note:**

- The following setting values are available when using the PROFINET communication option card (SI-EP3).  
–0: Static  
–2: DCP
- When *F7-13 = 0*, set parameters *F7-01 to F7-12* [IP Address 1 to Gateway Address 4] to set the IP Address. Be sure to set a different IP address for each drive on the network.

■ **F7-14: Duplex Mode Selection**

No. (Hex.)	Name	Description	Default (Range)
F7-14 (03F2)	Duplex Mode Selection	<b>V/f</b> <b>CL-V/f</b> <b>OLV</b> <b>CLV</b> <b>AOLV</b> <b>OLV/PM</b> <b>AOLV/PM</b> <b>CLV/PM</b> <b>EZOLV</b> Sets the duplex mode setting method.	1 (0 - 8)

**0 : Half/Half**

**1 : Auto/Auto**

**2 : Full/Full**

**3 : Half/Auto**

Port 1 is set to “Half” and port 2 is set to “Auto”.

**4 : Half/Full**

Port 1 is set to “Half” and port 2 is set to “Full”.

**5 : Auto/Half**

Port 1 is set to “Auto” and port 2 is set to “Half”.

**6 : Auto/Full**

Port 1 is set to “Auto” and port 2 is set to “Full”.

**7 : Full/Half**

Port 1 is set to “Full” and port 2 is set to “Half”.

**8 : Full/Auto**

Port 1 is set to “Full” and port 2 is set to “Auto”.

■ **F7-15: Communication Speed Selection**

No. (Hex.)	Name	Description	Default (Range)
F7-15 (03F3)	Communication Speed Selection	<b>V/f</b> <b>CL-V/f</b> <b>OLV</b> <b>CLV</b> <b>AOLV</b> <b>OLV/PM</b> <b>AOLV/PM</b> <b>CLV/PM</b> <b>EZOLV</b> Sets the communications speed.	10 (10, 102)

**10 : 10/10 Mbps**



**102 : 100/10 Mbps****Note:**

Set this parameter when  $F7-14 = 0$  or  $2$  [Duplex Mode Selection = Half/Half or Full/Full].

**■ F7-16: Timeout Value**

No. (Hex.)	Name	Description	Default (Range)
F7-16 (03F4)	Timeout Value	<b>V/f</b> <b>CL-V/f</b> <b>OLV</b> <b>CLV</b> <b>AOLV</b> <b>OLV/PM</b> <b>AOLV/PM</b> <b>CLV/PM</b> <b>EZOLV</b> Sets the detection time for a communications timeout.	0.0 s (0.0 - 30.0 s)

**Note:**

Set this parameter to 0.0 to disable the connection timeout function.

**■ F7-17: EtherNet/IP Speed Scaling Factor**

No. (Hex.)	Name	Description	Default (Range)
F7-17 (03F5)	EtherNet/IP Speed Scaling Factor	<b>V/f</b> <b>CL-V/f</b> <b>OLV</b> <b>CLV</b> <b>AOLV</b> <b>OLV/PM</b> <b>AOLV/PM</b> <b>CLV/PM</b> <b>EZOLV</b> Sets the scaling factor for the speed monitor in the EtherNet/IP Class ID 2AH Object.	0 (-15 - +15)

**■ F7-18: EtherNet/IP Current Scale Factor**

No. (Hex.)	Name	Description	Default (Range)
F7-18 (03F6)	EtherNet/IP Current Scale Factor	<b>V/f</b> <b>CL-V/f</b> <b>OLV</b> <b>CLV</b> <b>AOLV</b> <b>OLV/PM</b> <b>AOLV/PM</b> <b>CLV/PM</b> <b>EZOLV</b> Sets the scaling factor for the output current monitor in the EtherNet/IP Class ID 2AH Object.	0 (-15 - +15)

**■ F7-19: EtherNet/IP Torque Scale Factor**

No. (Hex.)	Name	Description	Default (Range)
F7-19 (03F7)	EtherNet/IP Torque Scale Factor	<b>V/f</b> <b>CL-V/f</b> <b>OLV</b> <b>CLV</b> <b>AOLV</b> <b>OLV/PM</b> <b>AOLV/PM</b> <b>CLV/PM</b> <b>EZOLV</b> Sets the scaling factor for the torque monitor in the EtherNet/IP Class ID 2AH Object.	0 (-15 - +15)

**■ F7-20: EtherNet/IP Power Scaling Factor**

No. (Hex.)	Name	Description	Default (Range)
F7-20 (03F8)	EtherNet/IP Power Scaling Factor	<b>V/f</b> <b>CL-V/f</b> <b>OLV</b> <b>CLV</b> <b>AOLV</b> <b>OLV/PM</b> <b>AOLV/PM</b> <b>CLV/PM</b> <b>EZOLV</b> Sets the scaling factor for the power monitor in the EtherNet/IP Class ID 2AH Object.	0 (-15 - +15)

**■ F7-21: EtherNet/IP Voltage Scale Factor**

No. (Hex.)	Name	Description	Default (Range)
F7-21 (03F9)	EtherNet/IP Voltage Scale Factor	<b>V/f</b> <b>CL-V/f</b> <b>OLV</b> <b>CLV</b> <b>AOLV</b> <b>OLV/PM</b> <b>AOLV/PM</b> <b>CLV/PM</b> <b>EZOLV</b> Sets the scaling factor for the voltage monitor in the EtherNet/IP Class ID 2AH Object.	0 (-15 - +15)

**■ F7-22: EtherNet/IP Time Scaling**

No. (Hex.)	Name	Description	Default (Range)
F7-22 (03FA)	EtherNet/IP Time Scaling	<b>V/f</b> <b>CL-V/f</b> <b>OLV</b> <b>CLV</b> <b>AOLV</b> <b>OLV/PM</b> <b>AOLV/PM</b> <b>CLV/PM</b> <b>EZOLV</b> Sets the scaling factor for the time monitor in the EtherNet/IP Class ID 2AH Object.	0 (-15 - +15)

### ■ F7-23 to F7-32: Dynamic Out Param 1 to 10 for CommCard

No. (Hex.)	Name	Description	Default (Range)
F7-23 to F7-27 (03FB - 03FF) F7-28 to F7-32 (0370 - 0374)	Dynamic Out Param 1 to 10 for CommCard	<p><b>V/f</b> <b>CL-V/f</b> <b>OLV</b> <b>CLV</b> <b>AOLV</b> <b>OLV/PM</b> <b>AOLV/PM</b> <b>CLV/PM</b> <b>EZOLV</b></p> <p>Sets Output Assembly 116. The drive writes the values from Output Assembly 116 to the MEMOBUS/Modbus address register that is stored for each parameter. The drive will not write the values from Output Assembly 116 to the registers when the MEMOBUS/Modbus address is 0.</p>	0

### ■ F7-33 to F7-42: Dynamic In Param 1 to 10 for CommCard

No. (Hex.)	Name	Description	Default (Range)
F7-33 to F7-42 (0375 - 037E)	Dynamic In Param 1 to 10 for CommCard	<p><b>V/f</b> <b>CL-V/f</b> <b>OLV</b> <b>CLV</b> <b>AOLV</b> <b>OLV/PM</b> <b>AOLV/PM</b> <b>CLV/PM</b> <b>EZOLV</b></p> <p>Sets Input Assembly 166. The drive sends the values from the MEMOBUS/Modbus address registers stored for each parameter to Input Assembly 166. The drive returns the default register value for the option card when the MEMOBUS/Modbus address is 0 and the value sent to Input Assembly 166 is not defined.</p>	0

### ■ F7-60: PZD1 Write (Control Word)

No. (Hex.)	Name	Description	Default (Range)
F7-60 (0780)	PZD1 Write (Control Word)	<p><b>V/f</b> <b>CL-V/f</b> <b>OLV</b> <b>CLV</b> <b>AOLV</b> <b>OLV/PM</b> <b>AOLV/PM</b> <b>CLV/PM</b> <b>EZOLV</b></p> <p>Sets the MEMOBUS/Modbus address for PZD1 (PPO output). PZD1 (PPO output) functions as the STW when <i>F7-60 = 0, 1, or 2</i>.</p>	0

### ■ F7-61: PZD2 Write (Frequency Reference)

No. (Hex.)	Name	Description	Default (Range)
F7-61 (0781)	PZD2 Write (Frequency Reference)	<p><b>V/f</b> <b>CL-V/f</b> <b>OLV</b> <b>CLV</b> <b>AOLV</b> <b>OLV/PM</b> <b>AOLV/PM</b> <b>CLV/PM</b> <b>EZOLV</b></p> <p>Sets the MEMOBUS/Modbus address for PZD2 (PPO output). PZD2 (PPO output) functions as the HSW when <i>F7-61 = 0, 1, or 2</i>.</p>	0

### ■ F7-62: PZD3 Write

No. (Hex.)	Name	Description	Default (Range)
F7-62 (0782)	PZD3 Write	<p><b>V/f</b> <b>CL-V/f</b> <b>OLV</b> <b>CLV</b> <b>AOLV</b> <b>OLV/PM</b> <b>AOLV/PM</b> <b>CLV/PM</b> <b>EZOLV</b></p> <p>Sets the MEMOBUS/Modbus address for PZD3 (PPO output). A value of 0, 1, or 2 will disable the PZD3 (PPO output) write operation to the MEMOBUS/Modbus register.</p>	0

### ■ F7-63: PZD4 Write

No. (Hex.)	Name	Description	Default (Range)
F7-63 (0783)	PZD4 Write	<p><b>V/f</b> <b>CL-V/f</b> <b>OLV</b> <b>CLV</b> <b>AOLV</b> <b>OLV/PM</b> <b>AOLV/PM</b> <b>CLV/PM</b> <b>EZOLV</b></p> <p>Sets the MEMOBUS/Modbus address for PZD4 (PPO output). A value of 0, 1, or 2 will disable the PZD4 (PPO output) write operation to the MEMOBUS/Modbus register.</p>	0

### ■ F7-64: PZD5 Write

No. (Hex.)	Name	Description	Default (Range)
F7-64 (0784)	PZD5 Write	<div style="display: flex; justify-content: space-between; font-size: small; font-weight: bold;"> <span>V/f</span> <span>CL-V/f</span> <span>OLV</span> <span>CLV</span> <span>AOLV</span> <span>OLV/PM</span> <span>AOLV/PM</span> <span>CLV/PM</span> <span>EZOLV</span> </div> <p>Sets the MEMOBUS/Modbus address for PZD5 (PPO output). A value of 0, 1, or 2 will disable the PZD5 (PPO output) write operation to the MEMOBUS/Modbus register.</p>	0

### ■ F7-65: PZD6 Write

No. (Hex.)	Name	Description	Default (Range)
F7-65 (0785)	PZD6 Write	<div style="display: flex; justify-content: space-between; font-size: small; font-weight: bold;"> <span>V/f</span> <span>CL-V/f</span> <span>OLV</span> <span>CLV</span> <span>AOLV</span> <span>OLV/PM</span> <span>AOLV/PM</span> <span>CLV/PM</span> <span>EZOLV</span> </div> <p>Sets the MEMOBUS/Modbus address for PZD6 (PPO output). A value of 0, 1, or 2 will disable the PZD6 (PPO output) write operation to the MEMOBUS/Modbus register.</p>	0

### ■ F7-66: PZD7 Write

No. (Hex.)	Name	Description	Default (Range)
F7-66 (0786)	PZD7 Write	<div style="display: flex; justify-content: space-between; font-size: small; font-weight: bold;"> <span>V/f</span> <span>CL-V/f</span> <span>OLV</span> <span>CLV</span> <span>AOLV</span> <span>OLV/PM</span> <span>AOLV/PM</span> <span>CLV/PM</span> <span>EZOLV</span> </div> <p>Sets the MEMOBUS/Modbus address for PZD7 (PPO output). A value of 0, 1, or 2 will disable the PZD7 (PPO output) write operation to the MEMOBUS/Modbus register.</p>	0

### ■ F7-67: PZD8 Write

No. (Hex.)	Name	Description	Default (Range)
F7-67 (0787)	PZD8 Write	<div style="display: flex; justify-content: space-between; font-size: small; font-weight: bold;"> <span>V/f</span> <span>CL-V/f</span> <span>OLV</span> <span>CLV</span> <span>AOLV</span> <span>OLV/PM</span> <span>AOLV/PM</span> <span>CLV/PM</span> <span>EZOLV</span> </div> <p>Sets the MEMOBUS/Modbus address for PZD8 (PPO output). A value of 0, 1, or 2 will disable the PZD8 (PPO output) write operation to the MEMOBUS/Modbus register.</p>	0

### ■ F7-68: PZD9 Write

No. (Hex.)	Name	Description	Default (Range)
F7-68 (0788)	PZD9 Write	<div style="display: flex; justify-content: space-between; font-size: small; font-weight: bold;"> <span>V/f</span> <span>CL-V/f</span> <span>OLV</span> <span>CLV</span> <span>AOLV</span> <span>OLV/PM</span> <span>AOLV/PM</span> <span>CLV/PM</span> <span>EZOLV</span> </div> <p>Sets the MEMOBUS/Modbus address for PZD9 (PPO output). A value of 0, 1, or 2 will disable the PZD9 (PPO output) write operation to the MEMOBUS/Modbus register.</p>	0

### ■ F7-69: PZD10 Write

No. (Hex.)	Name	Description	Default (Range)
F7-69 (0789)	PZD10 Write	<div style="display: flex; justify-content: space-between; font-size: small; font-weight: bold;"> <span>V/f</span> <span>CL-V/f</span> <span>OLV</span> <span>CLV</span> <span>AOLV</span> <span>OLV/PM</span> <span>AOLV/PM</span> <span>CLV/PM</span> <span>EZOLV</span> </div> <p>Sets the MEMOBUS/Modbus address for PZD10 (PPO output). A value of 0, 1, or 2 will disable the PZD10 (PPO output) write operation to the MEMOBUS/Modbus register.</p>	0

### ■ F7-70: PZD1 Read (Status Word)

No. (Hex.)	Name	Description	Default (Range)
F7-70 (078A)	PZD1 Read (Status Word)	<div style="display: flex; justify-content: space-between; font-size: small; font-weight: bold;"> <span>V/f</span> <span>CL-V/f</span> <span>OLV</span> <span>CLV</span> <span>AOLV</span> <span>OLV/PM</span> <span>AOLV/PM</span> <span>CLV/PM</span> <span>EZOLV</span> </div> <p>Sets the MEMOBUS/Modbus address for PZD1 (PPO Read). PZD1 (PPO input) functions as the ZSW when F7-70 = 0.</p>	0

### ■ F7-71: PZD2 Read (Output Frequency)

No. (Hex.)	Name	Description	Default (Range)
F7-71 (078B)	PZD2 Read (Output Frequency)	<div style="display: flex; justify-content: space-between; font-size: 0.8em; font-weight: bold; margin-bottom: 5px;"> <span>V/f</span> <span>CL-V/f</span> <span>OLV</span> <span>CLV</span> <span>AOLV</span> <span>OLV/PM</span> <span>AOLV/PM</span> <span>CLV/PM</span> <span>EZOLV</span> </div> Sets the MEMOBUS/Modbus address for PZD2 (PPO Read). PZD2 (PPO input) functions as the HIW when $F7-71 = 0$ .	0

### ■ F7-72: PZD3 Read

No. (Hex.)	Name	Description	Default (Range)
F7-72 (078C)	PZD3 Read	<div style="display: flex; justify-content: space-between; font-size: 0.8em; font-weight: bold; margin-bottom: 5px;"> <span>V/f</span> <span>CL-V/f</span> <span>OLV</span> <span>CLV</span> <span>AOLV</span> <span>OLV/PM</span> <span>AOLV/PM</span> <span>CLV/PM</span> <span>EZOLV</span> </div> Sets the MEMOBUS/Modbus address for PZD3 (PPO Read). A value of 0 will disable the PZD3 (PPO input) load operation from the MEMOBUS/Modbus register.	0

### ■ F7-73: PZD4 Read

No. (Hex.)	Name	Description	Default (Range)
F7-73 (078D)	PZD4 Read	<div style="display: flex; justify-content: space-between; font-size: 0.8em; font-weight: bold; margin-bottom: 5px;"> <span>V/f</span> <span>CL-V/f</span> <span>OLV</span> <span>CLV</span> <span>AOLV</span> <span>OLV/PM</span> <span>AOLV/PM</span> <span>CLV/PM</span> <span>EZOLV</span> </div> Sets the MEMOBUS/Modbus address for PZD4 (PPO Read). A value of 0 will disable the PZD4 (PPO input) load operation from the MEMOBUS/Modbus register.	0

### ■ F7-74: PZD5 Read

No. (Hex.)	Name	Description	Default (Range)
F7-74 (078E)	PZD5 Read	<div style="display: flex; justify-content: space-between; font-size: 0.8em; font-weight: bold; margin-bottom: 5px;"> <span>V/f</span> <span>CL-V/f</span> <span>OLV</span> <span>CLV</span> <span>AOLV</span> <span>OLV/PM</span> <span>AOLV/PM</span> <span>CLV/PM</span> <span>EZOLV</span> </div> Sets the MEMOBUS/Modbus address for PZD5 (PPO Read). A value of 0 will disable the PZD5 (PPO input) load operation from the MEMOBUS/Modbus register.	0

### ■ F7-75: PZD6 Read

No. (Hex.)	Name	Description	Default (Range)
F7-75 (078F)	PZD6 Read	<div style="display: flex; justify-content: space-between; font-size: 0.8em; font-weight: bold; margin-bottom: 5px;"> <span>V/f</span> <span>CL-V/f</span> <span>OLV</span> <span>CLV</span> <span>AOLV</span> <span>OLV/PM</span> <span>AOLV/PM</span> <span>CLV/PM</span> <span>EZOLV</span> </div> Sets the MEMOBUS/Modbus address for PZD6 (PPO Read). A value of 0 will disable the PZD6 (PPO input) load operation from the MEMOBUS/Modbus register.	0

### ■ F7-76: PZD7 Read

No. (Hex.)	Name	Description	Default (Range)
F7-76 (0790)	PZD7 Read	<div style="display: flex; justify-content: space-between; font-size: 0.8em; font-weight: bold; margin-bottom: 5px;"> <span>V/f</span> <span>CL-V/f</span> <span>OLV</span> <span>CLV</span> <span>AOLV</span> <span>OLV/PM</span> <span>AOLV/PM</span> <span>CLV/PM</span> <span>EZOLV</span> </div> Sets the MEMOBUS/Modbus address for PZD7 (PPO Read). A value of 0 will disable the PZD7 (PPO input) load operation from the MEMOBUS/Modbus register.	0

### ■ F7-77: PZD8 Read

No. (Hex.)	Name	Description	Default (Range)
F7-77 (0791)	PZD8 Read	<div style="display: flex; justify-content: space-between; font-size: 0.8em; font-weight: bold; margin-bottom: 5px;"> <span>V/f</span> <span>CL-V/f</span> <span>OLV</span> <span>CLV</span> <span>AOLV</span> <span>OLV/PM</span> <span>AOLV/PM</span> <span>CLV/PM</span> <span>EZOLV</span> </div> Sets the MEMOBUS/Modbus address for PZD8 (PPO Read). A value of 0 will disable the PZD8 (PPO input) load operation from the MEMOBUS/Modbus register.	0

### ■ F7-78: PZD9 Read

No. (Hex.)	Name	Description	Default (Range)
F7-78 (0792)	PZD9 Read	<div style="display: flex; justify-content: space-between; font-size: 0.8em; font-weight: bold; margin-bottom: 5px;"> <span>V/f</span> <span>CL-V/f</span> <span>OLV</span> <span>CLV</span> <span>AOLV</span> <span>OLV/PM</span> <span>AOLV/PM</span> <span>CLV/PM</span> <span>EZOLV</span> </div> Sets the MEMOBUS/Modbus address for PZD9 (PPO Read). A value of 0 will disable the PZD9 (PPO input) load operation from the MEMOBUS/Modbus register.	0

### ■ F7-79: PZD10 Read

No. (Hex.)	Name	Description	Default (Range)
F7-79 (0793)	PZD10 Read	<div style="display: flex; justify-content: space-between; font-size: 0.8em; font-weight: bold; margin-bottom: 5px;"> <span>V/f</span> <span>CL-V/f</span> <span>OLV</span> <span>CLV</span> <span>AOLV</span> <span>OLV/PM</span> <span>AOLV/PM</span> <span>CLV/PM</span> <span>EZOLV</span> </div> Sets the MEMOBUS/Modbus address for PZD10 (PPO Read). A value of 0 will disable the PZD10 (PPO input) load operation from the MEMOBUS/Modbus register.	0

## 11.8 H: Terminal Functions

*H parameters* are used to assign functions to external input and output terminals.

### ◆ H1: Digital Inputs

*H1 Parameters* set the MFDI terminal functions.

#### ■ H1-01 to H1-08 Terminal S1 to S8 Function Selection

The drive has 8 MFDI terminals. Refer to [Table 11.58](#) for drive default settings and functions.

**Table 11.58 MFDI Default Settings and Functions**

No.	Name	Default	Function
H1-01	Terminal S1 Function Selection	40 (F) <sup>*1</sup>	Forward RUN (2-Wire)
H1-02	Terminal S2 Function Selection	41 (F) <sup>*1</sup>	Reverse RUN (2-Wire)
H1-03	Terminal S3 Function Selection	24	External Fault (NO-Always-Coast)
H1-04	Terminal S4 Function Selection	14	Fault Reset
H1-05	Terminal S5 Function Selection	3 (0) <sup>*1</sup>	Multi-Step Speed Reference 1
H1-06	Terminal S6 Function Select	4 (3) <sup>*1</sup>	Multi-Step Speed Reference 2
H1-07	Terminal S7 Function Selection	6 (4) <sup>*1</sup>	Jog Reference Selection
H1-08	Terminal S8 Function Selection	8	Baseblock Command (N.O.)

<sup>\*1</sup> The value in parentheses identifies the default setting when you set *A1-03* = 3330 [*Initialize Parameters = 3-Wire Initialization*]. Refer to [Table 11.59](#) and use *H1-xx* [*MFDI Function Select*] to set the function.

**Table 11.59 MFDI Setting Values**

Setting	Function	Setting	Function
0 <sup>*1</sup>	3-Wire Sequence	16	Motor 2 Selection
1	LOCAL/REMOTE Selection	17 <sup>*1</sup>	Fast Stop (N.C.)
2	External Reference 1/2 Selection	18	Timer Function
3	Multi-Step Speed Reference 1	19	PID Disable
4	Multi-Step Speed Reference 2	1A	Accel/Decel Time Selection 2
5	Multi-Step Speed Reference 3	1B	Programming Lockout
6	Jog Reference Selection	1E	Reference Sample Hold
7	Accel/Decel Time Selection 1	20 to 2F <sup>*1</sup>	External Fault
8 <sup>*1</sup>	Baseblock Command (N.O.)	30	PID Integrator Reset
9 <sup>*1</sup>	Baseblock Command (N.C.)	31	PID Integrator Hold
A	Accel/Decel Ramp Hold	32	Multi-Step Speed Reference 4
B	Overheat Alarm (oH2)	34	PID Soft Starter Disable
C	Analog Terminal Enable Selection	35	PID Input (Error) Invert
D	Ignore Speed Fdbk (V/f w/o Enc)	3E	PID Setpoint Selection 1
E	ASR Integral Reset	3F	PID Setpoint Selection 2
F	Not Used	40 <sup>*1</sup>	Forward RUN (2-Wire)
10	Up Command	41 <sup>*1</sup>	Reverse RUN (2-Wire)
11	Down Command	42 <sup>*1</sup>	Run Command (2-Wire Sequence 2)
12 <sup>*1</sup>	Forward Jog	43 <sup>*1</sup>	FWD/REV (2-Wire Sequence 2)
13 <sup>*1</sup>	Reverse Jog	44	Add Offset Frequency 1 (d7-01)
14	Fault Reset	45	Add Offset Frequency 2 (d7-02)
15 <sup>*1</sup>	Fast Stop (N.O.)	46	Add Offset Frequency 3 (d7-03)

Setting	Function	Setting	Function
47	Node Setup (CANopen)	77	ASR Gain (C5-03) Select
60	DC Injection Braking Command	78	Analog TorqueRef Polarity Invert
61	Speed Search from Fmax	7A *1	KEB Ride-Thru 2 Activate (N.C.)
62	Speed Search from Fref	7B *1	KEB Ride-Thru 2 Activate (N.O.)
63	Field Weakening	7C *1	Short Circuit Braking (N.O.)
65 *1	KEB Ride-Thru 1 Activate (N.C.)	7D *1	Short Circuit Braking (N.C.)
66 *1	KEB Ride-Thru 1 Activate (N.O.)	7E	Reverse Rotation Identifier
67	Communications Test Mode	7F	PID Bi-Directional Enable
68	High Slip Braking (HSB) Activate	90 to 97 *1	DWEZ Digital Inputs 1 to 8
6A	Drive Enable	9F	DWEZ Disable
71	Torque Control	101 to 19F	Inverse input of 1 to 9F Does an inverse input on the function of the selected MFDI. To select the function for inverse input, enter two digits 01 to 9F for the "xx" in "1xx".
72	Zero Servo		
75	Up 2 Command		
76	Down 2 Command		

\*1 Inverse input is not available.

### ■ H1-01: Terminal S1 Function Selection

No. (Hex.)	Name	Description	Default (Range)
H1-01 (0438)	Terminal S1 Function Selection	<input type="checkbox"/> V/f <input type="checkbox"/> CL-V/f <input type="checkbox"/> OLV <input type="checkbox"/> CLV <input type="checkbox"/> AOLV <input type="checkbox"/> OLV/PM <input type="checkbox"/> AOLV/PM <input type="checkbox"/> CLV/PM <input type="checkbox"/> EZOLV Sets the function for MFDI terminal S1.	40 (1-19F)

Note:

The default setting is *F* when the drive is initialized for *3-Wire Initialization* [A1-03 = 3330].

### ■ H1-02: Terminal S2 Function Selection

No. (Hex.)	Name	Description	Default (Range)
H1-02 (0439)	Terminal S2 Function Selection	<input type="checkbox"/> V/f <input type="checkbox"/> CL-V/f <input type="checkbox"/> OLV <input type="checkbox"/> CLV <input type="checkbox"/> AOLV <input type="checkbox"/> OLV/PM <input type="checkbox"/> AOLV/PM <input type="checkbox"/> CLV/PM <input type="checkbox"/> EZOLV Sets the function for MFDI terminal S2.	41 (1 - 19F)

Note:

The default setting is *F* when the drive is initialized for *3-Wire Initialization* [A1-03 = 3330].

### ■ H1-03: Terminal S3 Function Selection

No. (Hex.)	Name	Description	Default (Range)
H1-03 (0400)	Terminal S3 Function Selection	<input type="checkbox"/> V/f <input type="checkbox"/> CL-V/f <input type="checkbox"/> OLV <input type="checkbox"/> CLV <input type="checkbox"/> AOLV <input type="checkbox"/> OLV/PM <input type="checkbox"/> AOLV/PM <input type="checkbox"/> CLV/PM <input type="checkbox"/> EZOLV Sets the function for MFDI terminal S3.	24 (0 - 19F)

### ■ H1-04: Terminal S4 Function Selection

No. (Hex.)	Name	Description	Default (Range)
H1-04 (0401)	Terminal S4 Function Selection	<input type="checkbox"/> V/f <input type="checkbox"/> CL-V/f <input type="checkbox"/> OLV <input type="checkbox"/> CLV <input type="checkbox"/> AOLV <input type="checkbox"/> OLV/PM <input type="checkbox"/> AOLV/PM <input type="checkbox"/> CLV/PM <input type="checkbox"/> EZOLV Sets the function for MFDI terminal S4.	14 (0 - 19F)

### ■ H1-05: Terminal S5 Function Selection

No. (Hex.)	Name	Description	Default (Range)
H1-05 (0402)	Terminal S5 Function Selection	<input type="checkbox"/> V/f <input type="checkbox"/> CL-V/f <input type="checkbox"/> OLV <input type="checkbox"/> CLV <input type="checkbox"/> AOLV <input type="checkbox"/> OLV/PM <input type="checkbox"/> AOLV/PM <input type="checkbox"/> CLV/PM <input type="checkbox"/> EZOLV Sets the function for MFDI terminal S5.	3 (0 - 19F)

**Note:**

The default setting is 0 when the drive is initialized for 3-Wire Initialization [A1-03 = 3330].

### ■ H1-06: Terminal S6 Function Selection

No. (Hex.)	Name	Description	Default (Range)
H1-06 (0403)	Terminal S6 Function Selection	<input type="checkbox"/> V/f <input type="checkbox"/> CL-V/f <input type="checkbox"/> OLV <input type="checkbox"/> CLV <input type="checkbox"/> AOLV <input type="checkbox"/> OLV/PM <input type="checkbox"/> AOLV/PM <input type="checkbox"/> CLV/PM <input type="checkbox"/> EZOLV Sets the function for MFDI terminal S6.	4 (0 - 19F)

**Note:**

The default setting is 3 when the drive is initialized for 3-Wire Initialization [A1-03 = 3330].

### ■ H1-07: Terminal S7 Function Selection

No. (Hex.)	Name	Description	Default (Range)
H1-07 (0404)	Terminal S7 Function Selection	<input type="checkbox"/> V/f <input type="checkbox"/> CL-V/f <input type="checkbox"/> OLV <input type="checkbox"/> CLV <input type="checkbox"/> AOLV <input type="checkbox"/> OLV/PM <input type="checkbox"/> AOLV/PM <input type="checkbox"/> CLV/PM <input type="checkbox"/> EZOLV Sets the function for MFDI terminal S7.	6 (0 - 19F)

**Note:**

The default setting is 4 when the drive is initialized for 3-Wire Initialization [A1-03 = 3330].

### ■ H1-08: Terminal S8 Function Selection

No. (Hex.)	Name	Description	Default (Range)
H1-08 (0405)	Terminal S8 Function Selection	<input type="checkbox"/> V/f <input type="checkbox"/> CL-V/f <input type="checkbox"/> OLV <input type="checkbox"/> CLV <input type="checkbox"/> AOLV <input type="checkbox"/> OLV/PM <input type="checkbox"/> AOLV/PM <input type="checkbox"/> CLV/PM <input type="checkbox"/> EZOLV Sets the function for MFDI terminal S8.	8 (0 - 19F)

### ■ H1-21: Terminal S1 Function Select 2

No. (Hex.)	Name	Description	Default (Range)
H1-21 (0B70)	Terminal S1 Function Select 2	<input type="checkbox"/> V/f <input type="checkbox"/> CL-V/f <input type="checkbox"/> OLV <input type="checkbox"/> CLV <input type="checkbox"/> AOLV <input type="checkbox"/> OLV/PM <input type="checkbox"/> AOLV/PM <input type="checkbox"/> CLV/PM <input type="checkbox"/> EZOLV Sets the second function for MFDI terminal S1.	F (1 - 19F)

When MFDI terminal S1 activates, it will operate the function set to H1-01 [Terminal S1 Function Selection] and the function set to H1-21 at the same time.

When the setting value is F, the function is disabled.

### ■ H1-22: Terminal S2 Function Select 2

No. (Hex.)	Name	Description	Default (Range)
H1-22 (0B71)	Terminal S2 Function Select 2	<input type="checkbox"/> V/f <input type="checkbox"/> CL-V/f <input type="checkbox"/> OLV <input type="checkbox"/> CLV <input type="checkbox"/> AOLV <input type="checkbox"/> OLV/PM <input type="checkbox"/> AOLV/PM <input type="checkbox"/> CLV/PM <input type="checkbox"/> EZOLV Sets the second function for MFDI terminal S2.	F (1 - 19F)

When MFDI terminal S2 activates, it will operate the function set to H1-02 [Terminal S2 Function Selection] and the function set to H1-22 at the same time.

When the setting value is F, the function is disabled.



### ■ H1-23: Terminal S3 Function Select 2

No. (Hex.)	Name	Description	Default (Range)
H1-23 (0B72)	Terminal S3 Function Select 2	<input type="checkbox"/> V/f <input type="checkbox"/> CL-V/f <input type="checkbox"/> OLV <input type="checkbox"/> CLV <input type="checkbox"/> AOLV <input type="checkbox"/> OLV/PM <input type="checkbox"/> AOLV/PM <input type="checkbox"/> CLV/PM <input type="checkbox"/> EZOLV Sets the second function for MFDI terminal S3.	F (1 - 19F)

When MFDI terminal S3 activates, it will operate the function set to *H1-03 [Terminal S3 Function Selection]* and the function set to *H1-23* at the same time.

When the setting value is *F*, the function is disabled.

### ■ H1-24: Terminal S4 Function Select 2

No. (Hex.)	Name	Description	Default (Range)
H1-24 (0B73)	Terminal S4 Function Select 2	<input type="checkbox"/> V/f <input type="checkbox"/> CL-V/f <input type="checkbox"/> OLV <input type="checkbox"/> CLV <input type="checkbox"/> AOLV <input type="checkbox"/> OLV/PM <input type="checkbox"/> AOLV/PM <input type="checkbox"/> CLV/PM <input type="checkbox"/> EZOLV Sets the second function for MFDI terminal S4.	F (1 - 19F)

When MFDI terminal S4 activates, it will operate the function set to *H1-04 [Terminal S4 Function Selection]* and the function set to *H1-24* at the same time.

When the setting value is *F*, the function is disabled.

### ■ H1-25: Terminal S5 Function Select 2

No. (Hex.)	Name	Description	Default (Range)
H1-25 (0B74)	Terminal S5 Function Select 2	<input type="checkbox"/> V/f <input type="checkbox"/> CL-V/f <input type="checkbox"/> OLV <input type="checkbox"/> CLV <input type="checkbox"/> AOLV <input type="checkbox"/> OLV/PM <input type="checkbox"/> AOLV/PM <input type="checkbox"/> CLV/PM <input type="checkbox"/> EZOLV Sets the second function for MFDI terminal S5.	F (1 - 19F)

When MFDI terminal S5 activates, it will operate the function set to *H1-05 [Terminal S5 Function Selection]* and the function set to *H1-25* at the same time.

When the setting value is *F*, the function is disabled.

### ■ H1-26: Terminal S6 Function Select 2

No. (Hex.)	Name	Description	Default (Range)
H1-26 (0B75)	Terminal S6 Function Select 2	<input type="checkbox"/> V/f <input type="checkbox"/> CL-V/f <input type="checkbox"/> OLV <input type="checkbox"/> CLV <input type="checkbox"/> AOLV <input type="checkbox"/> OLV/PM <input type="checkbox"/> AOLV/PM <input type="checkbox"/> CLV/PM <input type="checkbox"/> EZOLV Sets the second function for MFDI terminal S6.	F (1 - 19F)

When MFDI terminal S6 activates, it will operate the function set to *H1-06 [Terminal S6 Function Selection]* and the function set to *H1-26* at the same time.

When the setting value is *F*, the function is disabled.

### ■ H1-27: Terminal S7 Function Select 2

No. (Hex.)	Name	Description	Default (Range)
H1-27 (0B76)	Terminal S7 Function Select 2	<input type="checkbox"/> V/f <input type="checkbox"/> CL-V/f <input type="checkbox"/> OLV <input type="checkbox"/> CLV <input type="checkbox"/> AOLV <input type="checkbox"/> OLV/PM <input type="checkbox"/> AOLV/PM <input type="checkbox"/> CLV/PM <input type="checkbox"/> EZOLV Sets the second function for MFDI terminal S7.	F (1 - 19F)

When MFDI terminal S7 activates, it will operate the function set to *H1-07 [Terminal S7 Function Selection]* and the function set to *H1-27* at the same time.

When the setting value is *F*, the function is disabled.

### ■ H1-28: Terminal S8 Function Select 2

No. (Hex.)	Name	Description	Default (Range)
H1-28 (0B77)	Terminal S8 Function Select 2	<input type="checkbox"/> V/f <input type="checkbox"/> CL-V/f <input type="checkbox"/> OLV <input type="checkbox"/> CLV <input type="checkbox"/> AOLV <input type="checkbox"/> OLV/PM <input type="checkbox"/> AOLV/PM <input type="checkbox"/> CLV/PM <input type="checkbox"/> EZOLV Sets the second function for MFDI terminal S8.	F (1 - 19F)

When MFDI terminal S8 activates, it will operate the function set to *H1-08 [Terminal S8 Function Selection]* and the unction set to *H1-28* at the same time.

When the setting value is *F*, the function is disabled.

■ **MEMOBUS/Modbus MFDI 1 to 3 Function Selection**

You can set the function for the MFDI to MEMOBUS register *bit 0 to 2 of [15C0(Hex.)]*. Use *H1-40* to *H1-42 [Extend MFDI Function Selection]* to select the function.

**Note:**

- Refer to H1-xx “MFDI setting values” for the setting values of the MFDI.
- You cannot set *0 [3-Wire Sequence]* or *20 to 2F [External fault]* in *H1-40* to *H1-42*.
- When you will not use *H1-40* to *H1-42*, set them to *F [Through Mode]*.
- You cannot use MFDI for digital input option D1-A3 at the same time as function selection for MEMOBUS/Modbus MFDI 1 to 3.

■ **H1-40: Mbus Reg 15C0h bit0 Input Func**

No. (Hex.)	Name	Description	Default (Range)
H1-40 (0B54)	Mbus Reg 15C0h bit0 Input Func	<div style="display: flex; justify-content: space-between; font-size: 0.8em; font-weight: bold;"> <span>V/f</span> <span>CL-V/f</span> <span>OLV</span> <span>CLV</span> <span>AOLV</span> <span>OLV/PM</span> <span>AOLV/PM</span> <span>CLV/PM</span> <span>EZOLV</span> </div> Sets the MFDI function for <i>bit 0</i> of MEMOBUS/Modbus register <i>15C0 (Hex.)</i> .	F (1 - 19F)

■ **H1-41: Mbus Reg 15C0h bit1 Input Func**

No. (Hex.)	Name	Description	Default (Range)
H1-41 (0B55)	Mbus Reg 15C0h bit1 Input Func	<div style="display: flex; justify-content: space-between; font-size: 0.8em; font-weight: bold;"> <span>V/f</span> <span>CL-V/f</span> <span>OLV</span> <span>CLV</span> <span>AOLV</span> <span>OLV/PM</span> <span>AOLV/PM</span> <span>CLV/PM</span> <span>EZOLV</span> </div> Sets the MFDI function for <i>bit 1</i> of MEMOBUS/Modbus register <i>15C0 (Hex.)</i> .	F (1 - 19F)

■ **H1-42: Mbus Reg 15C0h bit2 Input Func**

No. (Hex.)	Name	Description	Default (Range)
H1-42 (0B56)	Mbus Reg 15C0h bit2 Input Func	<div style="display: flex; justify-content: space-between; font-size: 0.8em; font-weight: bold;"> <span>V/f</span> <span>CL-V/f</span> <span>OLV</span> <span>CLV</span> <span>AOLV</span> <span>OLV/PM</span> <span>AOLV/PM</span> <span>CLV/PM</span> <span>EZOLV</span> </div> Sets the MFDI function for <i>bit 2</i> of MEMOBUS/Modbus register <i>15C0 (Hex.)</i> .	F (1 - 19F)

◆ **Multi-Function Digital Input Setting Values**

Selects a function set with *H1-01* to *H1-08*.

■ **0: 3-Wire Sequence**

Setting	Function	Description
0	3-Wire Sequence	<div style="display: flex; justify-content: space-between; font-size: 0.8em; font-weight: bold;"> <span>V/f</span> <span>CL-V/f</span> <span>OLV</span> <span>CLV</span> <span>AOLV</span> <span>OLV/PM</span> <span>AOLV/PM</span> <span>CLV/PM</span> <span>EZOLV</span> </div> Sets the direction of motor rotation for 3-wire sequence.

If the 3-wire sequence is set to a terminal that is not MFDI terminals S1 and S2, these terminals will be the input terminals for Forward run/Reverse run command.

The drive will automatically set terminal S1 to Run command (RUN) and terminal S2 to Stop command (STOP). When terminal S1 (Run command) activates for 1 ms minimum, the drive rotates the motor. When terminal S2 (Stop command) deactivates, the drive stops. When terminal Sx that is set in 3-wire sequence deactivates, the drive operates in the forward direction, and when it activates, the drive operates in the reverse direction.

**WARNING!** *Sudden Movement Hazard. Set the MFDI terminal parameters before you close the control circuit wiring. Incorrect Run/Stop circuit sequence settings can cause death or serious injury from moving equipment.*

**WARNING! Sudden Movement Hazard.**

When using a 3-Wire sequence:

- Set the drive for 3-Wire sequence.
- Set b1-17 = 0 [Run Command at Power Up = Disregard Existing RUN Command]
- Wire the drive for 3-Wire sequence.

If these three conditions are correct, the motor can rotate in reverse when energizing the drive:

- The drive is wired for 3-Wire sequence.
- The drive is set for a 2-Wire sequence (default).
- b1-17 = 1 [Accept Existing RUN Command]

Failure to obey can cause death or serious injury from moving equipment.

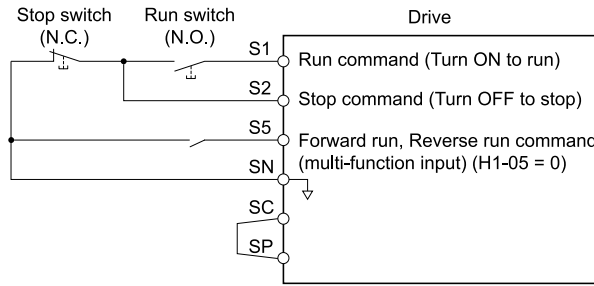


Figure 11.79 3-Wire Sequence Wiring Example

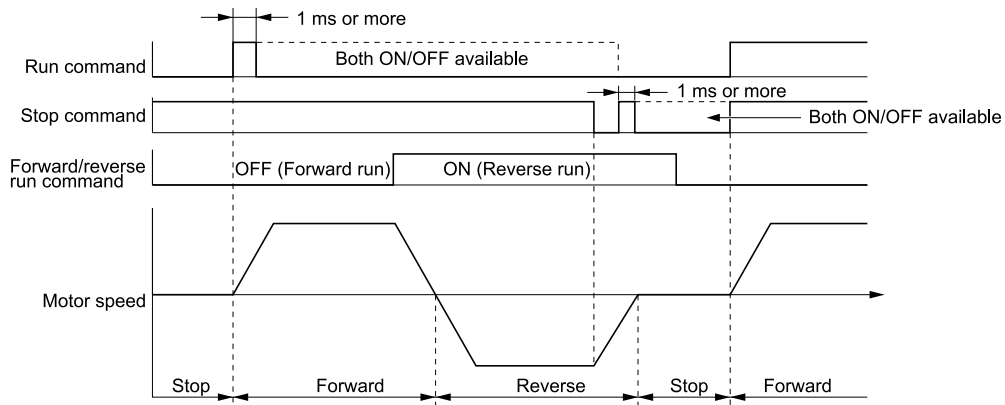




Figure 11.80 3-Wire Sequence Time Chart

**Note:**



- To input the Run command, activate the terminal for 1 ms minimum.
- The default setting for b1-17 [Run Command at Power Up] is 0 [Disregard Existing RUN Command]. If you enable the Run command

when the drive is energized, the protective function will activate and the  will flash quickly. If Run is permitted in the application, set b1-17 = 1 [Accept Existing RUN Command].

**■ 1: LOCAL/REMOTE Selection**

Setting	Function	Description
1	LOCAL/REMOTE Selection	 Sets drive control for the keypad (LOCAL) or an external source (REMOTE).

**Note:**

- When the MFDI terminal sets the LOCAL/REMOTE selection,  on the keypad is disabled.
- When LOCAL Mode is selected, the green light for  comes on.
- When the Run command is ON, you cannot switch between LOCAL Mode and REMOTE Mode.

**ON : LOCAL**

The keypad is the Frequency reference source and Run command source.

**OFF : REMOTE**

The frequency reference and Run command settings are set in b1-01, b1-02 [Frequency Reference Selection 1/2] or b1-15, b1-16 [Run Command Selection 1/2].

## ■ 2: External Reference 1/2 Selection

Setting	Function	Description
2	External Reference 1/2 Selection	<div style="display: flex; justify-content: space-between; align-items: center;"> <span>V/f</span> <span>CL-V/f</span> <span>OLV</span> <span>CLV</span> <span>AOLV</span> <span>OLV/PM</span> <span>AOLV/PM</span> <span>CLV/PM</span> <span>EZOLV</span> </div> <p>Sets the drive to use Run command source 1/2 or Reference command source 1/2 when in REMOTE Mode.</p>

**Note:**

When the drive is receiving a Run command, you cannot switch between reference sources.

**ON : b1-15 = [Frequency Reference Selection 2], b1-16 [Run Command Selection 2]**

**OFF : b1-01 = [Frequency Reference Selection 1], b1-02 [Run Command Selection 1]**

## ■ 3: Multi-Step Speed Reference 1

Setting	Function	Description
3	Multi-Step Speed Reference 1	<div style="display: flex; justify-content: space-between; align-items: center;"> <span>V/f</span> <span>CL-V/f</span> <span>OLV</span> <span>CLV</span> <span>AOLV</span> <span>OLV/PM</span> <span>AOLV/PM</span> <span>CLV/PM</span> <span>EZOLV</span> </div> <p>Uses speed references d1-01 to d1-08 [Multi-Step Speed Reference] to set a multi-step speed reference.</p>

**Note:**

Refer to "Setting Procedures for Multi-step Speed Operation" in "d: Reference Settings" for more information.

## ■ 4: Multi-Step Speed Reference 2

Setting	Function	Description
4	Multi-Step Speed Reference 2	<div style="display: flex; justify-content: space-between; align-items: center;"> <span>V/f</span> <span>CL-V/f</span> <span>OLV</span> <span>CLV</span> <span>AOLV</span> <span>OLV/PM</span> <span>AOLV/PM</span> <span>CLV/PM</span> <span>EZOLV</span> </div> <p>Uses speed references d1-01 to d1-08 [Multi-Step Speed Reference] to set a multi-step speed reference.</p>

**Note:**

Refer to "Setting Procedures for Multi-step Speed Operation" in "d: Reference Settings" for more information.

## ■ 5: Multi-Step Speed Reference 3

Setting	Function	Description
5	Multi-Step Speed Reference 3	<div style="display: flex; justify-content: space-between; align-items: center;"> <span>V/f</span> <span>CL-V/f</span> <span>OLV</span> <span>CLV</span> <span>AOLV</span> <span>OLV/PM</span> <span>AOLV/PM</span> <span>CLV/PM</span> <span>EZOLV</span> </div> <p>Uses speed references d1-01 to d1-08 [Multi-Step Speed Reference] to set a multi-step speed reference.</p>

**Note:**

Refer to "Setting Procedures for Multi-step Speed Operation" in "d: Reference Settings" for more information.

## ■ 6: Jog Reference Selection

Setting	Function	Description
6	Jog Reference Selection	<div style="display: flex; justify-content: space-between; align-items: center;"> <span>V/f</span> <span>CL-V/f</span> <span>OLV</span> <span>CLV</span> <span>AOLV</span> <span>OLV/PM</span> <span>AOLV/PM</span> <span>CLV/PM</span> <span>EZOLV</span> </div> <p>Sets the drive to use the JOG Frequency Reference (JOG command) set in d1-17. The JOG Frequency Reference (JOG command) overrides Frequency References 1 to 16 (d1-01 to d1-16).</p>

## ■ 7: Accel/Decel Time Selection 1

Setting	Function	Description
7	Accel/Decel Time Selection 1	<div style="display: flex; justify-content: space-between; align-items: center;"> <span>V/f</span> <span>CL-V/f</span> <span>OLV</span> <span>CLV</span> <span>AOLV</span> <span>OLV/PM</span> <span>AOLV/PM</span> <span>CLV/PM</span> <span>EZOLV</span> </div> <p>Sets the drive to use Acceleration/Deceleration Time 1 [C1-01, C1-02] or Acceleration/Deceleration Time 2 [C1-03, C1-04].</p>

**Note:**

Refer to "C1: Accel & Decel Time" for more information.

## ■ 8: Baseblock Command (N.O.)

Setting	Function	Description
8	Baseblock Command (N.O.)	<div style="display: flex; justify-content: space-between; align-items: center;"> <span>V/f</span> <span>CL-V/f</span> <span>OLV</span> <span>CLV</span> <span>AOLV</span> <span>OLV/PM</span> <span>AOLV/PM</span> <span>CLV/PM</span> <span>EZOLV</span> </div> <p>Sets the command that stops drive output and coasts the motor to stop when the input is ON.</p>

The keypad flashes *bb* [Baseblock]. If you cancel the baseblock command when the Run command is active, the drive will restart the motor and use the speed search function.

**WARNING! Sudden Movement Hazard.** When you use the Baseblock command with hoist applications, make sure that you close the holding brake when you input the Baseblock command and the drive shuts off its output. Failure to do obey can cause death or serious injury if the load moves or falls when motor suddenly coasts after you input the Baseblock command.

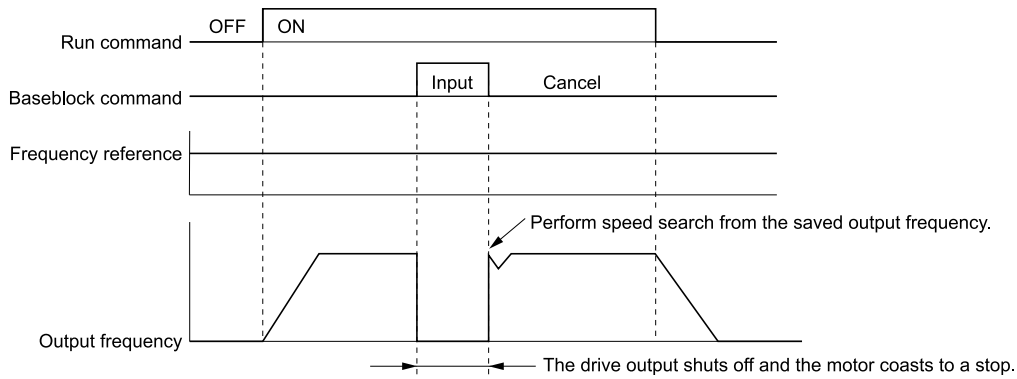


Figure 11.81 Baseblock Command Time Chart

**ON : Baseblock (drive output stop)**

**OFF : Normal operation**

■ **9: Baseblock Command (N.C.)**

Setting	Function	Description
9	Baseblock Command (N.C.)	<span>V/f</span> <span>CL-V/f</span> <span>OLV</span> <span>CLV</span> <span>AOLV</span> <span>OLV/PM</span> <span>AOLV/PM</span> <span>CLV/PM</span> <span>EZOLV</span> Sets the command that stops drive output and coasts the motor to stop when the input terminal is OFF.

The keypad flashes *bb* [Baseblock]. If you cancel the baseblock command when the Run command is active, the drive will restart the motor and use the speed search function.

**ON : Normal operation**

**OFF : Baseblock (drive output stop)**

**WARNING! Sudden Movement Hazard.** When you use the Baseblock command with hoist applications, make sure that you close the holding brake when you input the Baseblock command and the drive shuts off its output. Failure to do obey can cause death or serious injury if the load moves or falls when motor suddenly coasts after you input the Baseblock command.

■ **A: Accel/Decel Ramp Hold**

Setting	Function	Description
A	Accel/Decel Ramp Hold	<span>V/f</span> <span>CL-V/f</span> <span>OLV</span> <span>CLV</span> <span>AOLV</span> <span>OLV/PM</span> <span>AOLV/PM</span> <span>CLV/PM</span> <span>EZOLV</span> Momentarily pauses motor acceleration and deceleration when the terminal is turned ON, retains the output frequency that was stored in the drive at the time of the pause, and restarts motor operation.

If the terminal is deactivated, the drive restarts acceleration and deceleration.

When the acceleration/deceleration ramp hold terminal is activated and  $d4-01 = 1$  [Freq Reference Retention Select = Enabled], the drive will store the output frequency in memory. While the acceleration/deceleration ramp hold command is activated, the drive will always restart the motor at this output frequency.

**Note:**

Refer to “d4-01: Freq Reference Retention Select” for more information.

■ **B: Drive Overheat Alarm (oH2)**

Setting	Function	Description
B	Overheat Alarm (oH2)	<span>V/f</span> <span>CL-V/f</span> <span>OLV</span> <span>CLV</span> <span>AOLV</span> <span>OLV/PM</span> <span>AOLV/PM</span> <span>CLV/PM</span> <span>EZOLV</span> Sets the drive to display an <i>oH2</i> [Drive Overheat Warning] alarm when the input terminal is ON. The alarm does not have an effect on drive operation.

### ■ C: Analog Terminal Enable Selection

Setting	Function	Description
C	Analog Terminal Enable Selection	<div style="display: flex; justify-content: space-between; font-size: small;"> <span>V/f</span> <span>CL-V/f</span> <span>OLV</span> <span>CLV</span> <span>AOLV</span> <span>OLV/PM</span> <span>AOLV/PM</span> <span>CLV/PM</span> <span>EZOLV</span> </div> Sets the command that enables or disables the terminals selected in H3-14 [Analog Input Terminal Enable Sel].

**ON** : Terminal selected with H3-14 is enabled

**OFF** : Terminal selected with H3-14 is disabled

### ■ D: Ignore Speed Fdbk (V/f w/o Enc)

Setting	Function	Description
D	Ignore Speed Fdbk (V/f w/o Enc)	<div style="display: flex; justify-content: space-between; font-size: small;"> <span>V/f</span> <span>CL-V/f</span> <span>OLV</span> <span>CLV</span> <span>AOLV</span> <span>OLV/PM</span> <span>AOLV/PM</span> <span>CLV/PM</span> <span>EZOLV</span> </div> Sets the command to disable speed feedback control and run the drive in V/f control or use speed feedback from the encoder.

**ON** : Speed feedback control disable (V/f Control)

**OFF** : Speed feedback control enable (Closed Loop V/f Control)

### ■ E: ASR Integral Reset

Setting	Function	Description
E	ASR Integral Reset	<div style="display: flex; justify-content: space-between; font-size: small;"> <span>V/f</span> <span>CL-V/f</span> <span>OLV</span> <span>CLV</span> <span>AOLV</span> <span>OLV/PM</span> <span>AOLV/PM</span> <span>CLV/PM</span> <span>EZOLV</span> </div> Sets the command to reset the integral value and use PI control or P control for the speed control loop.

**ON** : P control

**OFF** : PI control

### ■ F: Not Used

Setting	Function	Description
F	Not Used	<div style="display: flex; justify-content: space-between; font-size: small;"> <span>V/f</span> <span>CL-V/f</span> <span>OLV</span> <span>CLV</span> <span>AOLV</span> <span>OLV/PM</span> <span>AOLV/PM</span> <span>CLV/PM</span> <span>EZOLV</span> </div> Setting for terminals that are not being used or terminals being used in through mode.

Through Mode uses the signal input to the terminal as a digital input for the upper sequence through a communication option or MEMOBUS/Modbus communications. This input signal does not have an effect on drive operation.

### ■ 10: Up Command

Setting	Function	Description
10	Up Command	<div style="display: flex; justify-content: space-between; font-size: small;"> <span>V/f</span> <span>CL-V/f</span> <span>OLV</span> <span>CLV</span> <span>AOLV</span> <span>OLV/PM</span> <span>AOLV/PM</span> <span>CLV/PM</span> <span>EZOLV</span> </div> Sets the command to use a button to increase the drive frequency reference. You must also set Setting 11 [Down Command].

**ON** : Raises the frequency reference.

**OFF** : Holds the current frequency reference.

**Note:**

- If you only set the Up command or only set the Down command, the drive will detect *oPE03* [Multi-Function Input Setting Err].
- If you set two or more of these functions at the same time, *oPE03* occurs:
  - Up/Down command
  - Accel/Decel Ramp Hold
  - Reference sample hold
  - Offset Frequency 1, 2, 3 addition
  - Up/Down 2 Command
- You can use the Up/Down command when the keypad is in REMOTE mode and when  $b1-01 \neq 0$  [Frequency Reference Selection 1 ≠ Keypad].
- The Up/Down command does not function when you use *External Reference 1/2 Selection* [ $H1-xx = 2$ ] to switch to parameter  $b1-15$  [Frequency Reference Selection 2].

When you input the Up command, the frequency reference increases. When you input the Down command, the frequency reference decreases.

The Up and Down commands are more important than all other frequency references. When the Up/Down command is enabled, the drive will ignore these frequency references:

- Frequency reference from Keypad [ $b1-01 = 0$ ]
- Frequency reference from Analog Input [ $b1-01 = 1$ ]
- Frequency reference from Pulse Train Input [ $b1-01 = 4$ ]

Table 11.60 shows the Up and Down commands with their operation.

**Table 11.60 Up Command and Down Command**

Command status		Drive operation
Up command (10)	Down command (11)	
OFF	OFF	Keeps the current frequency reference.
ON	OFF	Increases the frequency reference.
OFF	ON	Decreases the frequency reference.
ON	ON	Keeps the current frequency reference.

#### Combine Frequency Reference Hold Functions and Up/Down Commands

- When you clear the Run command or when  $d4-01 = 0$  [Freq Reference Retention Function = Disabled] and you restart the drive, the Up/Down command resets to 0.
- When  $d4-01 = 1$  [Enabled], the drive saves the frequency reference set during the Up/Down command. When you cycle the Run command or restart the drive, the drive saves the frequency reference value and restarts the motor at this frequency value. After you clear the Run command, activate the terminal set for the Up command or Down command to set the saved reference value to 0.

**Note:**

Refer to “d4-01: Freq Reference Retention Select” for more information.

#### Combine Upper/Lower Limits of the Frequency Reference and the Up/Down Commands

Set the upper limit value of the frequency reference to  $d2-01$  [Frequency Reference Upper Limit].

Use an analog input or  $d2-02$  [Frequency Reference Lower Limit] to set the lower limit value of the frequency reference. The configurable values change when the setting for  $d4-10$  [Up/Down Freq Lower Limit Select] changes. When you input a Run command, these are the lower limits of the frequency reference:

- When the lower limit of the frequency reference is set only for  $d2-02$ , the drive accelerates the motor to the lower limit value of the frequency reference at the same time that you input the Run command.
- When the lower limit of the frequency reference is set only for analog input, the drive accelerates the motor to the lower limit value of the frequency reference when the Run command, and Up command or Down command for the drive is enabled. When only the Run command is enabled, the motor does not start.
- When these conditions occur, the drive accelerates the motor to the  $d2-02$  setting value when the Run command is input. When the motor accelerates to the setting value of  $d2-02$ , if the Up/Down command is enabled, the motor accelerates to the lower limit value of the analog input.
  - The lower limit value of the frequency reference is set for the analog input and  $d2-02$
  - The lower limit value of the analog input is higher than the setting value of  $d2-02$

**Note:**

Refer to “d4-10: Up/Down Freq Lower Limit Select” for details.

Figure 11.82 shows an example of how Up/Down command operates. In this example, the lower limit value of the frequency reference is set in  $d2-02$ . The time chart when Freq Reference Retention Select [ $d4-01$ ] is enabled and disabled is shown in Figure 11.82.

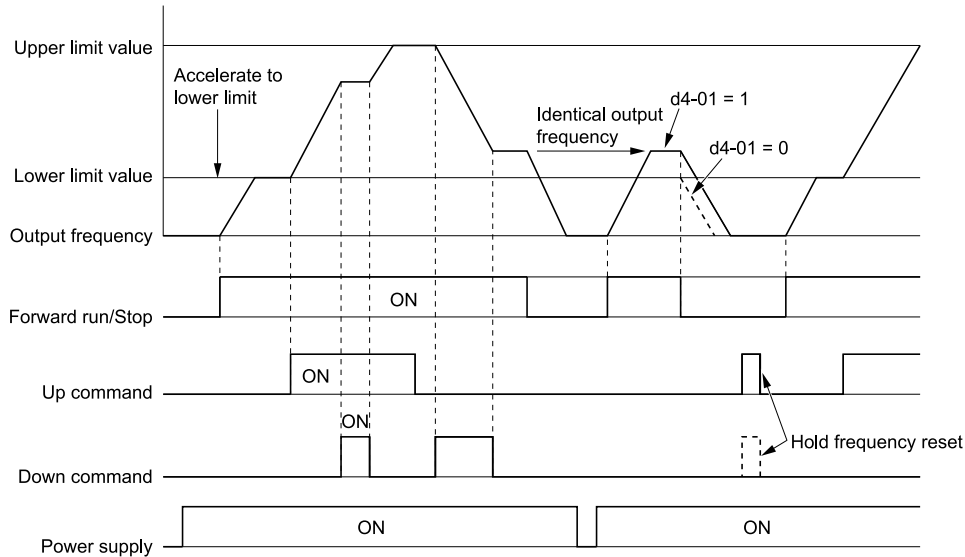


Figure 11.82 Up/Down Command Time Chart

■ 11: Down Command

Setting	Function	Description
11	Down Command	<div style="display: flex; justify-content: space-between; font-size: small;"> <span>V/f</span> <span>CL-V/f</span> <span>OLV</span> <span>CLV</span> <span>AOLV</span> <span>OLV/PM</span> <span>AOLV/PM</span> <span>CLV/PM</span> <span>EZOLV</span> </div> <p>Sets the command to decrease the drive frequency reference using a button. Users must also set <i>Setting 10 [Up Command]</i>.</p>

**ON** : Decreases the frequency reference.

**OFF** : Holds the current frequency reference.

**Note:**

- If you set only the Up command or only the Down command, the drive will detect *oPE03 [Multi-Function Input Setting Err]*.
- If you set two or more of these functions at the same time, the drive will detect *oPE03*:
  - Up/Down command
  - Accel/Decel Ramp Hold
  - Reference sample hold
  - Offset Frequency 1, 2, 3 addition
  - Up/Down 2 Command
- To use the Up/Down command when the keypad is in REMOTE mode or *b1-01 ≠ 0 [Frequency Reference Selection 1 ≠ Keypad]*. If you use *External Reference 1/2 Selection [H1-xx = 2]* to switch to parameter *b1-15 [Frequency Reference Selection 2]*, the Up/Down command will not function.

When you input the Up command, the frequency reference will increase. When you input the Down command, the frequency reference will decrease.

The Up and Down commands have priority over all other frequency references. When you enable the Up/Down command, the drive will ignore these frequency references:

- Frequency reference from Keypad [*b1-01 = 0*]
- Frequency reference from Analog Input [*b1-01 = 1*]
- Frequency reference from Pulse Train Input [*b1-01 = 4*]

■ 12: Forward Jog

Setting	Function	Description
12	Forward Jog	<div style="display: flex; justify-content: space-between; font-size: small;"> <span>V/f</span> <span>CL-V/f</span> <span>OLV</span> <span>CLV</span> <span>AOLV</span> <span>OLV/PM</span> <span>AOLV/PM</span> <span>CLV/PM</span> <span>EZOLV</span> </div> <p>Sets the command to operate the motor in the forward direction at the Jog Frequency set in <i>d1-17 [Jog Reference]</i>.</p>

**Note:**

- It is not necessary to input the Run command.
- The Forward JOG command has priority over all other frequency references.
- When the Forward JOG and Reverse JOG commands are activated at the same time for 500 ms or longer, the drive will ramp to stop.



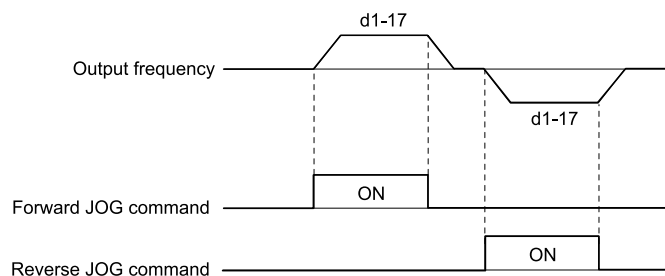


Figure 11.83 JOG Operation Pattern

### 13: Reverse Jog

Setting	Function	Description
13	Reverse Jog	<b>V/f</b> <b>CL-V/f</b> <b>OLV</b> <b>CLV</b> <b>AOLV</b> <b>OLV/PM</b> <b>AOLV/PM</b> <b>CLV/PM</b> <b>EZOLV</b> Sets the command to operate the motor in the reverse direction at the Jog Frequency set in <i>d1-17</i> [Jog Reference].


**Note:**

- It is not necessary to input the Run command.
- The Reverse JOG command has priority over all other frequency references.
- When the Forward JOG and Reverse JOG commands are activated at the same time for 500 ms or longer, the drive will ramp to stop.

### 14: Fault Reset

Setting	Function	Description
14	Fault Reset	<b>V/f</b> <b>CL-V/f</b> <b>OLV</b> <b>CLV</b> <b>AOLV</b> <b>OLV/PM</b> <b>AOLV/PM</b> <b>CLV/PM</b> <b>EZOLV</b> Sets the command to reset the current fault when the Run command is inactive.

If the drive detects a fault, the drive will activate the fault relay output, turn off the output, and the motor will coast to stop.

If the drive detects a fault for which you can set the stopping method, apply the appropriate Stopping Method. Then push  (RESET) on the keypad to turn the Run command OFF, or activate the fault reset terminal to reset the fault.

**Note:**

The drive ignores the fault reset command when the Run command is active. Remove the Run command before trying to reset a fault.

### 15: Fast Stop (N.O.)

Setting	Function	Description
15	Fast Stop (N.O.)	<b>V/f</b> <b>CL-V/f</b> <b>OLV</b> <b>CLV</b> <b>AOLV</b> <b>OLV/PM</b> <b>AOLV/PM</b> <b>CLV/PM</b> <b>EZOLV</b> Sets the command to ramp to stop in the deceleration time set in <i>C1-09</i> [Fast Stop Time] when the input terminal is ON while the drive is operating.

If you cancel the fast stop input, the drive will not restart the motor until you meet these conditions:

- Fully stop the motor
- Cancel the Run command
- Cancel the fast stop command

**Note:**

- To use the N.C. switch to input the fast stop command, set 17 (Fast Stop (N.C.)).
- Refer to “C1-09: Fast Stop Time” for more information.

**NOTICE:** Fast deceleration can trigger an overvoltage fault. To prevent and uncontrolled motor and to make sure that the motor stops quickly and safely, set an applicable Fast Stop time in *C1-09* [Fast Stop Time]. When there is a fault, the drive output will turn off and the motor will coast to stop.

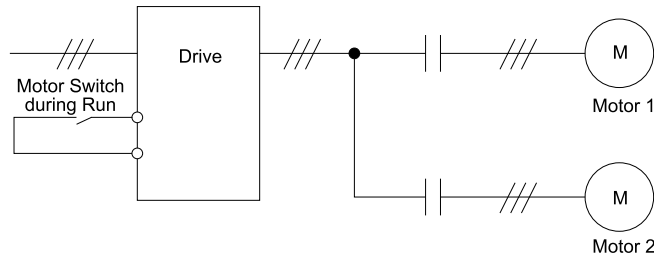
### 16: Motor 2 Selection

Setting	Function	Description
16	Motor 2 Selection	<b>V/f</b> <b>CL-V/f</b> <b>OLV</b> <b>CLV</b> <b>AOLV</b> <b>OLV/PM</b> <b>AOLV/PM</b> <b>CLV/PM</b> <b>EZOLV</b> Sets the command for the drive to operate motor 1 or motor 2. Stop the motors before switching.

You can use an external input to switch operation between two induction motors. The drive will save the control methods, V/f patterns, and motor parameters for the two motors.

**ON : Selects motor 2**

**OFF : Selects motor 1**



When you select motor 2, the drive will switch to motor 2 parameters.

**Table 11.61 Parameters that Switch between Motor 1 and Motor 2**

Parameters	Motor 2 Selection	
	OFF (Motor 1)	ON (Motor 2)
C1-xx [Accel & Decel Time]	C1-01 to C1-04	C1-05 to C1-08
C3-xx [Slip Compensation]	C3-01 to C3-04	C3-21 to C3-24
C4-xx [Torque Compensation]	C4-01	C4-07
C5-xx [Automatic Speed Regulator (ASR)]	C5-01 to C5-08, C5-12, C5-17, C5-18	C5-21 to C5-28, C5-32, C5-37, C5-38
E1-xx, E3-xx [V/f Patterns] E2-xx, E-4xx [Motor Parameters]	E1-xx, E2-xx	E3-xx, E4-xx
F1-xx [Number of PG pulses per Revolution]	F1-01 to F1-21	F1-02 to F1-04, F1-08 to F1-11, F1-14, F1-31 to F1-37

**Note:**

- When you use 2 motors, the drive applies the protective function set in L1-01 [Motor Overload Protection Select] to motor 1 and motor 2.
- You cannot switch between motors 1 and 2 during run. If you try to switch motors when they are running, it will cause a rUn error.
- After you switch between encoder motors, you must wait 500 ms minimum to input a Run command. You must wait 200 ms minimum for other control methods.

**■ 17: Fast Stop (N.C.)**

Setting	Function	Description
17	Fast Stop (N.C.)	<div style="display: flex; justify-content: space-between; font-size: small;"> <span>V/f</span> <span>CL-V/f</span> <span>OLV</span> <span>CLV</span> <span>AOLV</span> <span>OLV/PM</span> <span>AOLV/PM</span> <span>CLV/PM</span> <span>EZOLV</span> </div> <p>Sets the command to ramp to stop in the deceleration time set in C1-09 [Fast Stop Time] when the input terminal is ON while the drive is operating.</p>

If you cancel the fast stop input, the drive will not restart the motor until you meet these conditions:

- Fully stop the motor
- Cancel the Run command
- Cancel the fast stop command

**Note:**

- To use the N.O. switch to input the fast stop command, set 15 (Fast Stop (N.O.)).
- Refer to “C1-09: Fast Stop Time” for more information.

**NOTICE:** Fast deceleration can trigger an overvoltage fault. To prevent and uncontrolled motor and to make sure that the motor stops quickly and safely, set an applicable Fast Stop time in C1-09 [Fast Stop Time]. When there is a fault, the drive output will turn off and the motor will coast to stop.

Figure 11.84 shows an example of how fast stop operates.

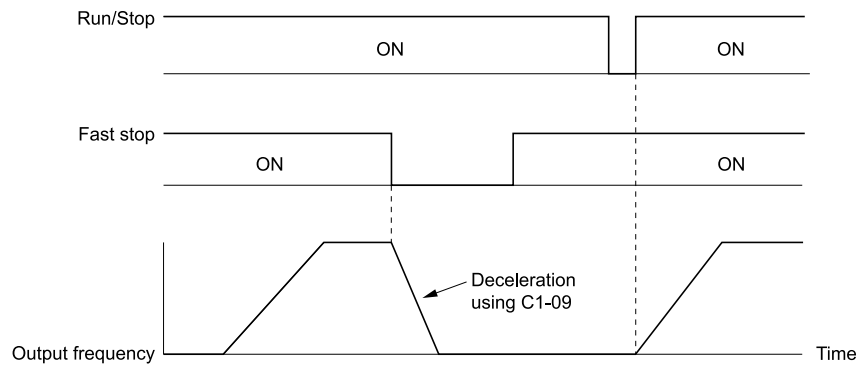


Figure 11.84 Fast Stop Time Chart

## ■ 18: Timer Function

Setting	Function	Description
18	Timer Function	<input type="checkbox"/> V/f <input type="checkbox"/> CL-V/f <input type="checkbox"/> OLV <input type="checkbox"/> CLV <input type="checkbox"/> AOLV <input type="checkbox"/> OLV/PM <input type="checkbox"/> AOLV/PM <input type="checkbox"/> CLV/PM <input type="checkbox"/> EZOLV Sets the command to start the timer function. Use this setting with <i>Timer Output [H2-xx = 12]</i> .

### Note:

Refer to “b4: Timer Function” for more information.

## ■ 19: PID Disable

Setting	Function	Description
19	PID Disable	<input type="checkbox"/> V/f <input type="checkbox"/> CL-V/f <input type="checkbox"/> OLV <input type="checkbox"/> CLV <input type="checkbox"/> AOLV <input type="checkbox"/> OLV/PM <input type="checkbox"/> AOLV/PM <input type="checkbox"/> CLV/PM <input type="checkbox"/> EZOLV Sets the command to disable PID control when $b5-01 = 1$ to $8$ [ <i>PID Mode Setting = Enabled</i> ].

**ON** : PID control disabled

**OFF** : PID control enabled

## ■ 1A: Accel/Decel Time Selection 2

Setting	Function	Description
1A	Accel/Decel Time Selection 2	<input type="checkbox"/> V/f <input type="checkbox"/> CL-V/f <input type="checkbox"/> OLV <input type="checkbox"/> CLV <input type="checkbox"/> AOLV <input type="checkbox"/> OLV/PM <input type="checkbox"/> AOLV/PM <input type="checkbox"/> CLV/PM <input type="checkbox"/> EZOLV Set this function and $H1-xx = 7$ [ <i>Accel/decel Time Selection 1</i> ] together. Sets the drive to use <i>Acceleration/Deceleration Time 3 [C1-05, C1-06]</i> or <i>Acceleration/Deceleration Time 4 [C1-07, C1-08]</i> .

### Note:

Refer to “C1: Accel & Decel Time” for more information.

## ■ 1B: Programming Lockout

Setting	Function	Description
1B	Programming Lockout	<input type="checkbox"/> V/f <input type="checkbox"/> CL-V/f <input type="checkbox"/> OLV <input type="checkbox"/> CLV <input type="checkbox"/> AOLV <input type="checkbox"/> OLV/PM <input type="checkbox"/> AOLV/PM <input type="checkbox"/> CLV/PM <input type="checkbox"/> EZOLV Sets the command to prevent parameter changes when the terminal is OFF.

You can continue to view parameter setting values when the terminal is *OFF* [*Parameters Cannot be Edited*].

**ON** : Program Lockout

**OFF** : Parameter Write Prohibit

## ■ 1E: Reference Sample Hold

Setting	Function	Description
1E	Reference Sample Hold	<input type="checkbox"/> V/f <input type="checkbox"/> CL-V/f <input type="checkbox"/> OLV <input type="checkbox"/> CLV <input type="checkbox"/> AOLV <input type="checkbox"/> OLV/PM <input type="checkbox"/> AOLV/PM <input type="checkbox"/> CLV/PM <input type="checkbox"/> EZOLV Sets the command to sample the frequency reference at terminals A1, A2, or A3 and hold the frequency reference at that frequency.

When the terminal is active for 100 ms, this function reads a sample of the analog frequency reference and holds that sample. When you input the sample/hold command again, the function again reads a sample of the analog frequency reference and holds that sample. When you turn off the power, the drive erases the saved analog frequency and resets the frequency reference to 0.

Figure 11.85 shows an example of how the function operates.

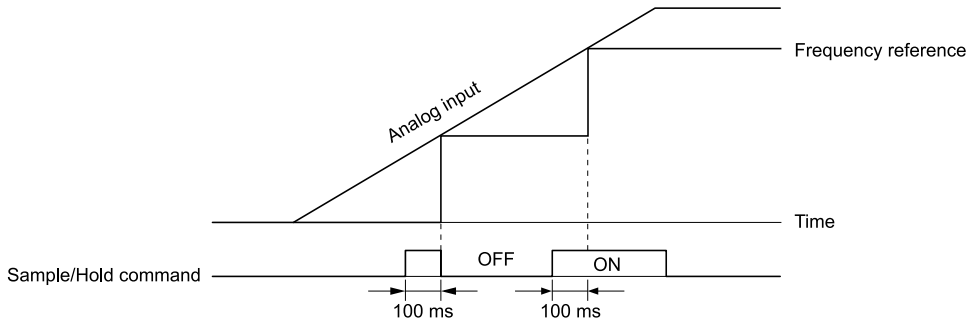


Figure 11.85 Reference Sample Hold

You cannot set the Reference Sample Hold function at the same time as these functions:

- $H1-xx = A$  [Accel/Decel Ramp Hold]
- $H1-xx = 10, 11$  [Up Command, Down Command]
- $H1-xx = 44$  to  $46$  [Add Offset Frequency 1 to 3]
- $H1-xx = 75, 76$  [Up 2 Command, Down 2 Command]

If you set them at the same time, the drive will detect  $oPE03$  [Multi-Function Input Setting Err].

### ■ 20 to 2F: External Fault

Setting	Function	Description
20 to 2F	External Fault	<div style="display: flex; justify-content: space-between; font-size: small;"> <span>V/f</span> <span>CL-V/f</span> <span>OLV</span> <span>CLV</span> <span>AOLV</span> <span>OLV/PM</span> <span>AOLV/PM</span> <span>CLV/PM</span> <span>EZOLV</span> </div> Sets a command to stop the drive when a failure or fault occurs on an external device.

If an external fault is input to the drive, the keypad will show  $EFx$  [External Fault (Terminal  $Sx$ )], where x is the number of the terminal (terminal  $Sx$ ) to which the external fault signal is assigned. For example, when an external fault signal is input to terminal  $S3$ , the keypad will show  $EF3$ .

Use these conditions to select the value to set in  $H1-xx$ :

- Signal input method from peripheral devices
- External fault detection method
- Motor stopping method (operation after external fault detection)

Table 11.62 shows the relation between the conditions and the value set to  $H1-xx$ .

Table 11.62 Stopping Methods for External Fault

Setting	Signal Input Method from Peripheral Devices <sup>*1</sup>		External Fault Detection Method <sup>*2</sup>		Stopping Method			
	N.O.	N.C.	Always Detected	Detected during RUN Only	Ramp to Stop (Fault)	Coast to Stop (Fault)	Fast Stop (Fault)	Continuous Operation (Alarm Only)
20	x	-	x	-	x	-	-	-
21	-	x	x	-	x	-	-	-
22	x	-	-	x	x	-	-	-
23	-	x	-	x	x	-	-	-
24	x	-	x	-	-	x	-	-
25	-	x	x	-	-	x	-	-
26	x	-	-	x	-	x	-	-
27	-	x	-	x	-	x	-	-
28	x	-	x	-	-	-	x	-
29	-	x	x	-	-	-	x	-
2A	x	-	-	x	-	-	x	-
2B	-	x	-	x	-	-	x	-
2C	x	-	x	-	-	-	-	x

Setting	Signal Input Method from Peripheral Devices <sup>*1</sup>		External Fault Detection Method <sup>*2</sup>		Stopping Method			
	N.O.	N.C.	Always Detected	Detected during RUN Only	Ramp to Stop (Fault)	Coast to Stop (Fault)	Fast Stop (Fault)	Continuous Operation (Alarm Only)
2D	-	x	x	-	-	-	-	x
2E	x	-	-	x	-	-	-	x
2F	-	x	-	x	-	-	-	x

\*1 Set the terminal to N.O. (detects external fault when switched ON) or N.C. (detects external fault when switched OFF).

\*2 Set the drive to always detect each fault or to detect only during run.

### ■ 30: PID Integrator Reset

Setting	Function	Description
30	PID Integrator Reset	<b>V/f</b> <b>CL-V/f</b> <b>OLV</b> <b>CLV</b> <b>AOLV</b> <b>OLV/PM</b> <b>AOLV/PM</b> <b>CLV/PM</b> <b>EZOLV</b> Sets the command to reset and hold the PID control integral to 0 when the terminal is ON.

**Note:**

Refer to "PID control block diagram" for more information.

### ■ 31: PID Integrator Hold

Setting	Function	Description
31	PID Integrator Hold	<b>V/f</b> <b>CL-V/f</b> <b>OLV</b> <b>CLV</b> <b>AOLV</b> <b>OLV/PM</b> <b>AOLV/PM</b> <b>CLV/PM</b> <b>EZOLV</b> Sets the command to hold the integral value of the PID control while the terminal is activated.

When you turn off the input terminal, PID control restarts the integral.

**Note:**

Refer to "PID control block diagram" for more information.

### ■ 32: Multi-Step Speed Reference 4

Setting	Function	Description
32	Multi-Step Speed Reference 4	<b>V/f</b> <b>CL-V/f</b> <b>OLV</b> <b>CLV</b> <b>AOLV</b> <b>OLV/PM</b> <b>AOLV/PM</b> <b>CLV/PM</b> <b>EZOLV</b> Sets the command to switch <i>d1-09</i> to <i>d1-16</i> [Reference 9 to 16] with multi-step speed references 1, 2 and 3.

**Note:**

Refer to "Setting procedure for the multi-step speed operation" for more information.

### ■ 34: PID Soft Starter Disable

Setting	Function	Description
34	PID Soft Starter Disable	<b>V/f</b> <b>CL-V/f</b> <b>OLV</b> <b>CLV</b> <b>AOLV</b> <b>OLV/PM</b> <b>AOLV/PM</b> <b>CLV/PM</b> <b>EZOLV</b> Sets the PID soft starter function.

#### ON : Disabled

Disables *b5-17* [PID Accel/Decel Time].

#### OFF : Enabled

Enables *b5-17* [PID Accel/Decel Time].

**Note:**

Refer to "PID control block diagram" for more information.

### ■ 35: PID Input (Error) Invert

Setting	Function	Description
35	PID Input (Error) Invert	<b>V/f</b> <b>CL-V/f</b> <b>OLV</b> <b>CLV</b> <b>AOLV</b> <b>OLV/PM</b> <b>AOLV/PM</b> <b>CLV/PM</b> <b>EZOLV</b> Sets the command to turn the terminal ON and OFF to switch the PID input level (polarity).

**Note:**

Refer to "PID control block diagram" for more information.

■ 3E: PID Setpoint Selection 1

Setting	Function	Description
3E	PID Setpoint Selection 1	<div style="display: flex; justify-content: space-between; font-size: small;"> <span>V/f</span> <span>CL-V/f</span> <span>OLV</span> <span>CLV</span> <span>AOLV</span> <span>OLV/PM</span> <span>AOLV/PM</span> <span>CLV/PM</span> <span>EZOLV</span> </div> <p>Set this function and <math>H1-xx = 3F</math> [PID Setpoint Selection 2] together. Sets the function to switch the PID setpoint to <math>b5-58</math> to <math>b5-60</math> [PID Setpoint 2 to 4].</p>

Refer to “b5-58 to b5-60: PID Setpoint 2 to 4” for more information.

■ 3F: PID Setpoint Selection 2

Setting	Function	Description
3F	PID Setpoint Selection 2	<div style="display: flex; justify-content: space-between; font-size: small;"> <span>V/f</span> <span>CL-V/f</span> <span>OLV</span> <span>CLV</span> <span>AOLV</span> <span>OLV/PM</span> <span>AOLV/PM</span> <span>CLV/PM</span> <span>EZOLV</span> </div> <p>Set this function and <math>H1-xx = 3E</math> [PID Setpoint Selection 1] together. Sets the function to switch the PID setpoint to <math>b5-58</math> to <math>b5-60</math> [PID Setpoint 2 to 4].</p>

Refer to “b5-58 to b5-60: PID Setpoint 2 to 4” for more information.

■ 40: Forward RUN (2-Wire)

Setting	Function	Description
40	Forward RUN (2-Wire)	<div style="display: flex; justify-content: space-between; font-size: small;"> <span>V/f</span> <span>CL-V/f</span> <span>OLV</span> <span>CLV</span> <span>AOLV</span> <span>OLV/PM</span> <span>AOLV/PM</span> <span>CLV/PM</span> <span>EZOLV</span> </div> <p>Sets the Forward Run command for 2-wire sequence 1. Set this function and <math>H1-xx = 41</math> [Reverse Run Command (2-Wire Seq)] together.</p>

ON : Forward Run

OFF : Run Stop

Note:

- Turning ON the Forward Run command terminal and the Reverse Run command terminal will cause alarm *EF* [FWD/REV Run Command Input Error] and the motor will ramp to stop.
- Initialize the drive with a 2-wire sequence to set the Forward Run command to terminal S1.
- This function will not operate at the same time as  $H1-xx = 42, 43$  [Run Command/FWD/REV Command (2-Wire Seq 2)].

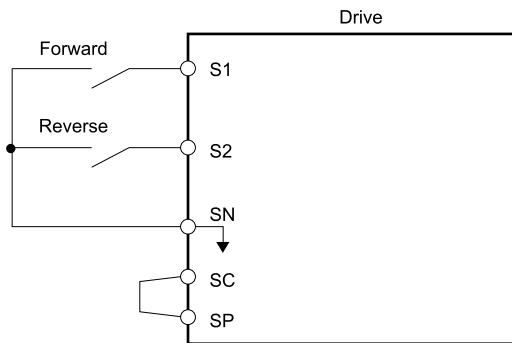


Figure 11.86 2-Wire Sequence Wiring Example

■ 41: Reverse RUN (2-Wire)

Setting	Function	Description
41	Reverse RUN (2-Wire)	<div style="display: flex; justify-content: space-between; font-size: small;"> <span>V/f</span> <span>CL-V/f</span> <span>OLV</span> <span>CLV</span> <span>AOLV</span> <span>OLV/PM</span> <span>AOLV/PM</span> <span>CLV/PM</span> <span>EZOLV</span> </div> <p>Sets the Reverse Run command for 2-wire sequence 1. Set this function and <math>H1-xx = 40</math> [Forward Run Command (2-Wire Seq)] together.</p>

ON : Reverse Run

OFF : Run Stop

Note:

- Turning ON the Forward Run command terminal and the Reverse Run command terminal will cause alarm *EF* [FWD/REV Run Command Input Error] and the motor will ramp to stop.
- Initialize the drive with a 2-wire sequence to set the Reverse Run command to terminal S2.
- This function will not operate at the same time as  $H1-xx = 42, 43$  [Run Command/FWD/REV Command (2-Wire Seq 2)].

### ■ 42: Run Command (2-Wire Sequence 2)

Setting	Function	Description
42	Run Command (2-Wire Sequence 2)	<div style="display: flex; justify-content: space-between; align-items: center;"> <span>V/f</span> <span>CL-V/f</span> <span>OLV</span> <span>CLV</span> <span>AOLV</span> <span>OLV/PM</span> <span>AOLV/PM</span> <span>CLV/PM</span> <span>EZOLV</span> </div> <p>Sets the Run command for 2-wire sequence 2. Set this function and <math>H1-xx = 43</math> [FWD/REV Command (2-Wire Seq 2)] together.</p>

**ON : Run**

**OFF : Stop**

**Note:**

This function will not operate at the same time as  $H1-xx = 40, 41$  [Forward/Reverse Run Command (2-Wire Seq)].

### ■ 43: FWD/REV (2-Wire Sequence 2)

Setting	Function	Description
43	FWD/REV (2-Wire Sequence 2)	<div style="display: flex; justify-content: space-between; align-items: center;"> <span>V/f</span> <span>CL-V/f</span> <span>OLV</span> <span>CLV</span> <span>AOLV</span> <span>OLV/PM</span> <span>AOLV/PM</span> <span>CLV/PM</span> <span>EZOLV</span> </div> <p>Sets the direction of motor rotation for 2-wire sequence 2. Set this function and <math>H1-xx = 42</math> [Run Command (2-Wire Sequence 2)] together.</p>

**ON : Reverse**

**OFF : Forward**

**Note:**

- You must input the Run command to rotate the motor.
- This function will not operate at the same time as  $H1-xx = 40, 41$  [Forward/Reverse Run Command (2-Wire Seq)].

### ■ 44: Add Offset Frequency 1 (d7-01)

Setting	Function	Description
44	Add Offset Frequency 1 (d7-01)	<div style="display: flex; justify-content: space-between; align-items: center;"> <span>V/f</span> <span>CL-V/f</span> <span>OLV</span> <span>CLV</span> <span>AOLV</span> <span>OLV/PM</span> <span>AOLV/PM</span> <span>CLV/PM</span> <span>EZOLV</span> </div> <p>Sets the function to add the offset frequency set in <math>d7-01</math> [Offset Frequency 1] to the frequency reference when the terminal activates.</p>

**Note:**

Refer to “d7: Offset Frequency” for more information.

### ■ 45: Add Offset Frequency 2 (d7-02)

Setting	Function	Description
45	Add Offset Frequency 2 (d7-02)	<div style="display: flex; justify-content: space-between; align-items: center;"> <span>V/f</span> <span>CL-V/f</span> <span>OLV</span> <span>CLV</span> <span>AOLV</span> <span>OLV/PM</span> <span>AOLV/PM</span> <span>CLV/PM</span> <span>EZOLV</span> </div> <p>Sets the function to add the offset frequency set in <math>d7-02</math> [Offset Frequency 2] to the frequency reference when the terminal activates.</p>

**Note:**

Refer to “d7: Offset Frequency” for more information.

### ■ 46: Add Offset Frequency 3 (d7-03)

Setting	Function	Description
46	Add Offset Frequency 3 (d7-03)	<div style="display: flex; justify-content: space-between; align-items: center;"> <span>V/f</span> <span>CL-V/f</span> <span>OLV</span> <span>CLV</span> <span>AOLV</span> <span>OLV/PM</span> <span>AOLV/PM</span> <span>CLV/PM</span> <span>EZOLV</span> </div> <p>Sets the function to add the offset frequency set in <math>d7-03</math> [Offset Frequency 3] to the frequency reference when the terminal activates.</p>

**Note:**

Refer to “d7: Offset Frequency” for more information.

### ■ 47: Node Setup (CANopen)

Setting	Function	Description
47	Node Setup (CANopen)	<div style="display: flex; justify-content: space-between; align-items: center;"> <span>V/f</span> <span>CL-V/f</span> <span>OLV</span> <span>CLV</span> <span>AOLV</span> <span>OLV/PM</span> <span>AOLV/PM</span> <span>CLV/PM</span> <span>EZOLV</span> </div> <p>Sets the function in CANopen communications to start the Node Setup function to set the drive node address from the host controller.</p>

### 60: DC Injection Braking Command

Setting	Function	Description
60	DC Injection Braking Command	<div style="display: flex; justify-content: space-between; font-size: small;"> <span>V/f</span> <span>CL-V/f</span> <span>OLV</span> <span>CLV</span> <span>AOLV</span> <span>OLV/PM</span> <span>AOLV/PM</span> <span>CLV/PM</span> <span>EZOLV</span> </div> <p>Sets the command to use DC Injection Braking to stop the motor.</p>

If you input the Run command or JOG command, it will cancel DC Injection Braking.

Figure 11.87 shows the DC Injection Braking function:

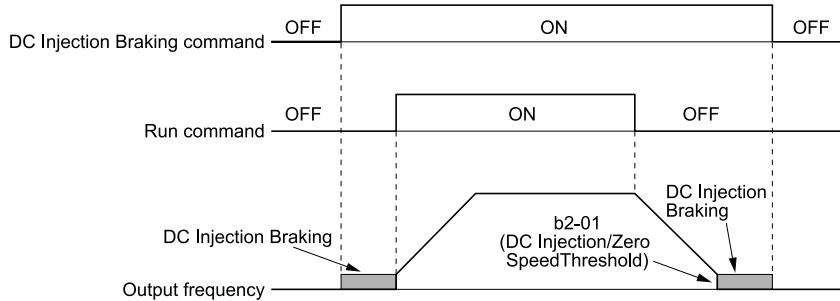


Figure 11.87 DC Injection Braking Time Chart

**Note:**

- When  $A1-02 = 8$  [Control Method Selection = EZ Open Loop Vector Control], this function is available if you use a PM motor.
- Refer to “b2: DC Circuit Braking” for more information.

### 61: Speed Search from Fmax

Setting	Function	Description
61	Speed Search from Fmax	<div style="display: flex; justify-content: space-between; font-size: small;"> <span>V/f</span> <span>CL-V/f</span> <span>OLV</span> <span>CLV</span> <span>AOLV</span> <span>OLV/PM</span> <span>AOLV/PM</span> <span>CLV/PM</span> <span>EZOLV</span> </div> <p>Sets the function to start speed search using an external reference although <math>b3-01 = 0</math> [Speed Search Selection at Start = Disabled].</p>

When the terminal is turned ON for  $b3-24 = 2$  [Speed Search Method Selection = Current Detection 2], the drive starts speed search from the maximum output frequency.

**Note:**

- The drive will detect  $oPE03$  [Multi-Function Input Setting Err] when  $H1-xx = 61$  and  $62$  are set at the same time.
- Refer to “b3: Speed Search” for more information.

### 62: Speed Search from Fref

Setting	Function	Description
62	Speed Search from Fref	<div style="display: flex; justify-content: space-between; font-size: small;"> <span>V/f</span> <span>CL-V/f</span> <span>OLV</span> <span>CLV</span> <span>AOLV</span> <span>OLV/PM</span> <span>AOLV/PM</span> <span>CLV/PM</span> <span>EZOLV</span> </div> <p>Sets the function to start speed search using an external reference although <math>b3-01 = 0</math> [Speed Search Selection at Start = Disabled].</p>

When the terminal is turned ON for  $b3-24 = 2$  [Speed Search Method Selection = Current Detection 2], the drive starts speed search from the frequency reference.

**Note:**

- The drive will detect  $oPE03$  [Multi-Function Input Setting Err] when  $H1-xx = 61$  and  $62$  are set at the same time.
- Refer to “b3: Speed Search” for more information.

### 63: Field Weakening

Setting	Function	Description
63	Field Weakening	<div style="display: flex; justify-content: space-between; font-size: small;"> <span>V/f</span> <span>CL-V/f</span> <span>OLV</span> <span>CLV</span> <span>AOLV</span> <span>OLV/PM</span> <span>AOLV/PM</span> <span>CLV/PM</span> <span>EZOLV</span> </div> <p>Sets the function to send the Field Weakening Level and Field Weakening Frequency Limit commands set in <math>d6-01</math> [Field Weakening Level] and <math>d6-02</math> [Field Weakening Frequency Limit] when the input terminal is activated.</p>

**Note:**

Refer to “d6: Field Weak & Field Force” for more information.



### ■ 65: KEB Ride-Thru 1 Activate (N.C.)

Setting	Function	Description
65	KEB Ride-Thru 1 Activate (N.C.)	<b>V/f</b> <b>CL-V/f</b> <b>OLV</b> <b>CLV</b> <b>AOLV</b> <b>OLV/PM</b> <b>AOLV/PM</b> <b>CLV/PM</b> <b>EZOLV</b> Sets operation of the KEB1 function through the KEB Ride-Thru 1 (N.C.).

**ON : Normal operation**

**OFF : Deceleration during momentary power loss**

When you enable KEB Ride-Thru 1, set *L2-29 [KEB Method Selection]*. The drive operates with the selected KEB method.

**Note:**

- If you set *KEB Ride-Thru 1 [H1-xx = 65, 66]* and *KEB Ride-Thru 2 [H1-xx = 7A, 7B]* at the same time, the drive will detect *oPE03 [Multi-Function Input Setting Err]*.
- Refer to "KEB Ride-Thru function" for more information.

### ■ 66: KEB Ride-Thru 1 Activate (N.O.)

Setting	Function	Description
66	KEB Ride-Thru 1 Activate (N.O.)	<b>V/f</b> <b>CL-V/f</b> <b>OLV</b> <b>CLV</b> <b>AOLV</b> <b>OLV/PM</b> <b>AOLV/PM</b> <b>CLV/PM</b> <b>EZOLV</b> Sets operation of the KEB1 function through the KEB Ride-Thru 1 (N.O.).

**ON : Deceleration during momentary power loss**

**OFF : Normal operation**

When you enable KEB Ride-Thru 1, set *L2-29 [KEB Method Selection]*. The drive operates with the selected KEB method.

**Note:**

- If you set *KEB Ride-Thru 1 [H1-xx = 65, 66]* and *KEB Ride-Thru 2 [H1-xx = 7A, 7B]* at the same time, the drive will detect *oPE03 [Multi-Function Input Setting Err]*.
- Refer to "KEB Ride-Thru function" for more information.

### ■ 67: Communications Test Mode

Setting	Function	Description
67	Communications Test Mode	<b>V/f</b> <b>CL-V/f</b> <b>OLV</b> <b>CLV</b> <b>AOLV</b> <b>OLV/PM</b> <b>AOLV/PM</b> <b>CLV/PM</b> <b>EZOLV</b> Set the function for the drive to self-test RS-485 serial communications operation.

The Self-Diagnostics function connects the transmission terminal of the control terminal block to the reception terminal. The function transmits the data that the drive sent to make sure that the drive can communicate correctly.

**Note:**

Refer to MEMOBUS/Modbus communications "Self-Diagnostics" for the self-diagnostics procedure.

### ■ 68: High Slip Braking (HSB) Activate

Setting	Function	Description
68	High Slip Braking (HSB) Activate	<b>V/f</b> <b>CL-V/f</b> <b>OLV</b> <b>CLV</b> <b>AOLV</b> <b>OLV/PM</b> <b>AOLV/PM</b> <b>CLV/PM</b> <b>EZOLV</b> Sets the command to use high-slip braking to stop the motor.

**Note:**

- When you restart the drive after you use high-slip braking, make sure that the drive fully stops the motor then clear the high-slip braking input.
- Refer to "n3: High Slip/Overex Braking" for more information.

### ■ 6A: Drive Enable

Setting	Function	Description
6A	Drive Enable	<b>V/f</b> <b>CL-V/f</b> <b>OLV</b> <b>CLV</b> <b>AOLV</b> <b>OLV/PM</b> <b>AOLV/PM</b> <b>CLV/PM</b> <b>EZOLV</b> Sets the function to show <i>dnE [Drive Enabled]</i> on the keypad and ignore Run commands when the terminal is OFF.

If you input the Run command before you turn ON the Drive Enable terminal, you must input the Run command again to operate the drive. When the terminal set for Drive Enable is turned OFF when the drive is operating, the drive will use the stopping method set in *b1-03 [Stopping Method Selection]* to stop the motor.

**ON : Run command is accepted.**

**OFF : Run command is disabled. When the drive is running, it stops according to *b1-03* setting.**

**■ 71: Torque Control**

Setting	Function	Description
71	Torque Control	<div style="display: flex; justify-content: space-between; font-size: small;"> <span>V/f</span> <span>CL-V/f</span> <span>OLV</span> <span>CLV</span> <span>AOLV</span> <span>OLV/PM</span> <span>AOLV/PM</span> <span>CLV/PM</span> <span>EZOLV</span> </div> <p>Sets the function to switch between torque control and speed control.</p>

**ON : Torque control**

**OFF : Speed control**

**Note:**

When this function is enabled, set *d5-01* = 0 [*Torque Control Selection = Speed Control*].

**Input the Speed/Torque Control Switchover Time**

Use parameter *d5-06* [*Speed/Torque Changeover Time*] to set the length of time, in milliseconds, that the drive will wait to switch between speed and torque control. When the speed/torque control switchover signal changes in the time set in *d5-06*, the three analog inputs will keep their present value. Complete the signal switchover with an external source in this time.

**Note:**

Refer to “Switch Speed Control and Torque Control” for more information.

**■ 72: Zero Servo**

Setting	Function	Description
72	Zero Servo	<div style="display: flex; justify-content: space-between; font-size: small;"> <span>V/f</span> <span>CL-V/f</span> <span>OLV</span> <span>CLV</span> <span>AOLV</span> <span>OLV/PM</span> <span>AOLV/PM</span> <span>CLV/PM</span> <span>EZOLV</span> </div> <p>Sets the function to hold a stopped motor.</p>

This function will hold a stopped motor if an external force is applied or an analog reference is offset.

**Note:**

- Refer to “b9: Zero Servo” for more information.
- When you use the Zero Servo function, keep the Run command ON. Zero servo stops the motor and if you turn OFF the Run command, it will not have power.

**■ 75: Up 2 Command**

Setting	Function	Description
75	Up 2 Command	<div style="display: flex; justify-content: space-between; font-size: small;"> <span>V/f</span> <span>CL-V/f</span> <span>OLV</span> <span>CLV</span> <span>AOLV</span> <span>OLV/PM</span> <span>AOLV/PM</span> <span>CLV/PM</span> <span>EZOLV</span> </div> <p>Sets the function to increase the frequency reference bias value to accelerate the motor when the terminal is activated. Set this function and <i>H1-xx</i> = 76 [<i>Down 2 Command</i>] together.</p>

When you activate the terminal set for Up2 Command, the bias will increase. When you activate the terminal set for Down 2 Command, the bias will decrease. When you activate or deactivate the two commands, the drive will hold the frequency reference. [Table 11.63](#) gives information about the relation between operation of the Up/Down 2 Command and *d4-01*, *d4-03*, *d4-05*.

**Note:**

- When using this function, set the optimal bias limit value with *d4-08* and *d4-09* [*Up/Down 2 Bias Upper Limit/Lower Limit*].
- Refer to “d4: Frequency Ref Up/Down & Hold” for more information.

Table 11.63 Up 2 Command, Down 2 Command

Function	Frequency Reference Source	d4-03	d4-05	d4-01	Operation	Storing the Frequency Reference or Frequency Bias
1	Multi-step speed reference	0.00	0	0	<ul style="list-style-type: none"> <li>When the Up 2 Command is active, the drive accelerates the motor (increases the bias value).</li> <li>When the Down 2 Command is active, the drive decelerates the motor (decreases the bias value)</li> <li>When the Up 2 Command and Down 2 Command are not active and when the Up 2 Command and Down 2 Command are active, the drive holds the output frequency (holds the bias value).</li> <li>When the frequency changes, it will reset the bias.</li> <li>For all other statuses, the drive will follow the frequency reference.</li> </ul>	Not stored.
2				1		When the bias value and frequency reference are constant for 5 seconds after the frequency reference hold starts, the drive will add the bias value to the enabled frequency reference, then reset.
3			1	-		<ul style="list-style-type: none"> <li>When the Up 2 Command is active, the drive accelerates the motor.</li> <li>When the Down 2 Command is active, the drive decelerates the motor.</li> <li>For all other statuses, the drive will follow the frequency reference.</li> </ul>
4	Multi-step speed reference	> 0	-	0	<ul style="list-style-type: none"> <li>When the Up 2 Command is active, the drive accelerates the motor to "Freq Reference + d4-03" (the bias value will increase to the value set in d4-03).</li> <li>When the Down 2 Command is active, the drive decelerates the motor to "Freq Reference - d4-03" (the bias value will decrease to the value set in d4-03).</li> <li>When the Up 2 Command and Down 2 Command are not active and when the Up 2 Command and Down 2 Command are active, the drive holds the output frequency (holds the bias value).</li> <li>When the frequency changes, it will reset the bias.</li> <li>For all other statuses, the drive will follow the frequency reference.</li> </ul>	Not stored.
5				1		When the bias value and frequency reference are constant for 5 seconds after the frequency reference hold starts, the drive will add the bias value to the enabled frequency reference, then reset.
6	Others (Analog input, transmission)	0	0	0	<ul style="list-style-type: none"> <li>When the Up 2 Command is active, the drive accelerates the motor (increases the bias value).</li> <li>When the Down 2 Command is active, the drive decelerates the motor (decreases the bias value).</li> <li>When the Up 2 Command and Down 2 Command are not active and when the Up 2 Command and Down 2 Command are active, the drive holds the output frequency (holds the bias value).</li> <li>During acceleration or deceleration, when the frequency reference increases or decreases more than d4-07 [<i>Analog Freq Ref Fluctuate Limit</i>], the drive holds the bias value until the output frequency and the actual frequency reference agree (speed agreement).</li> </ul>	Not stored.
7				1		When the bias value is constant for 5 seconds after the frequency reference hold starts, the drive will store the bias value in d4-06. You cannot rewrite the frequency reference is not possible. The drive will store only the bias value.

Function	Frequency Reference Source	d4-03	d4-05	d4-01	Operation	Storing the Frequency Reference or Frequency Bias
8	Others (Analog input, transmission)	0	1	-	<ul style="list-style-type: none"> <li>When the Up 2 Command is active, the drive accelerates the motor.</li> <li>When the Down 2 Command is active, the drive decelerates the motor.</li> <li>For all other statuses, the drive will follow the frequency reference.</li> </ul>	Not stored.
9		> 0	-	0	<ul style="list-style-type: none"> <li>When the Up 2 Command is active, the drive accelerates the motor to "Freq Reference + d4-03" (the bias value will increase to the value set in d4-03).</li> <li>When the Down 2 Command is active, the drive decelerates the motor to "Freq Reference - d4-03" (the bias value will decrease to the value set in d4-03).</li> <li>During acceleration or deceleration, when the frequency reference increases or decreases more than d4-07 [Analog Freq Ref Fluctuate Limit], the drive holds the bias value until the output frequency and the actual frequency reference agree (speed agreement).</li> </ul>	Not stored.
10				1	<ul style="list-style-type: none"> <li>When the Up 2 Command is active, the drive accelerates the motor to "Freq Reference + d4-03" (the bias value will increase to the value set in d4-03).</li> <li>When the Down 2 Command is active, the drive decelerates the motor to "Freq Reference - d4-03" (the bias value will decrease to the value set in d4-03).</li> <li>During acceleration or deceleration, when the frequency reference increases or decreases more than d4-07 [Analog Freq Ref Fluctuate Limit], the drive holds the bias value until the output frequency and the actual frequency reference agree (speed agreement).</li> </ul>	When the bias value is constant for 5 seconds after the frequency reference hold starts, the drive will store the bias value in d4-06. You cannot rewrite the frequency reference is not possible. The drive will store only the bias value.

■ 76: Down 2 Command

Setting	Function	Description
76	Down 2 Command	<p><input type="checkbox"/> V/f <input type="checkbox"/> CL-V/f <input type="checkbox"/> OLV <input type="checkbox"/> CLV <input type="checkbox"/> AOLV <input type="checkbox"/> OLV/PM <input type="checkbox"/> AOLV/PM <input type="checkbox"/> CLV/PM <input type="checkbox"/> EZOLV</p> <p>Sets the function to increase the frequency reference bias value to accelerate the motor when the terminal is activated. Set this function and H1-xx = 75 [Up 2 Command] together.</p>

When you activate the terminal set for Up2 Command, the bias will increase. When you activate the terminal set for Down 2 Command, the bias will decrease. When you activate or deactivate the two commands, the drive will hold the frequency reference.

**Note:**

- When using this function, set the optimal bias limit value with d4-08 and d4-09 [Up/Down 2 Bias Upper Limit/Lower Limit].
- Refer to "d4: Frequency Ref Up/Down & Hold" for more information.

■ 77: ASR Gain (C5-03) Select

Setting	Function	Description
77	ASR Gain (C5-03) Select	<p><input type="checkbox"/> V/f <input type="checkbox"/> CL-V/f <input type="checkbox"/> OLV <input checked="" type="checkbox"/> CLV <input type="checkbox"/> AOLV <input type="checkbox"/> OLV/PM <input type="checkbox"/> AOLV/PM <input type="checkbox"/> CLV/PM <input type="checkbox"/> EZOLV</p> <p>Sets the function to switch the ASR proportional gain set in C5-01 [ASR Proportional Gain 1] and C5-03 [ASR Proportional Gain 1/2].</p>

**ON : C5-03**

Switches the proportional gain to C5-03 [ASR Proportional Gain 2].

**OFF : C5-01**

Switches the proportional gain to C5-01 [ASR Proportional Gain 1].

**Note:**

Refer to "C5: Automatic Speed Regulator (ASR)" for more information.

■ 78: Analog TorqueRef Polarity Invert

Setting Value	Function	Description
78	Analog TorqueRef Polarity Invert	<p><input type="checkbox"/> V/f <input type="checkbox"/> CL-V/f <input type="checkbox"/> OLV <input checked="" type="checkbox"/> CLV <input type="checkbox"/> AOLV <input type="checkbox"/> OLV/PM <input type="checkbox"/> AOLV/PM <input type="checkbox"/> CLV/PM <input type="checkbox"/> EZOLV</p> <p>Sets the rotation direction of the external torque reference.</p>

**ON : External torque reference reverse direction**

**OFF : External torque reference forward direction**

### ■ 7A: KEB Ride-Thru 2 Activate (N.C.)

Setting	Function	Description
7A	KEB Ride-Thru 2 Activate (N.C.)	<div style="display: flex; justify-content: space-between; align-items: center;"> <span>V/f</span> <span>CL-V/f</span> <span>OLV</span> <span>CLV</span> <span>AOLV</span> <span>OLV/PM</span> <span>AOLV/PM</span> <span>CLV/PM</span> <span>EZOLV</span> </div> Sets operation of the KEB2 function through the KEB Ride-Thru 2 (N.C.).

**ON : Normal operation**

**OFF : Deceleration during momentary power loss**

When KEB Ride-Thru 2 is input, the drive will use Single Drive KEB Ride-Thru 2 for KEB operation. The *L2-29 [KEB Method Selection]* setting will not have an effect.

**Note:**

- If you set *KEB Ride-Thru 1 [H1-xx = 65, 66]* and *KEB Ride-Thru 2 [H1-xx = 7A, 7B]* at the same time, the drive will detect *oPE03 [Multi-Function Input Setting Err]*.
- Refer to “KEB Ride-Thru function” for more information.

### ■ 7B: KEB Ride-Thru 2 Activate (N.O.)

Setting	Function	Description
7B	KEB Ride-Thru 2 Activate (N.O.)	<div style="display: flex; justify-content: space-between; align-items: center;"> <span>V/f</span> <span>CL-V/f</span> <span>OLV</span> <span>CLV</span> <span>AOLV</span> <span>OLV/PM</span> <span>AOLV/PM</span> <span>CLV/PM</span> <span>EZOLV</span> </div> Sets operation of the KEB2 function through the KEB Ride-Thru 2 (N.O.).

**ON : Deceleration during momentary power loss**

**OFF : Normal operation**

When KEB Ride-Thru 2 is input, the drive will use Single Drive KEB Ride-Thru 2 for KEB operation. The *L2-29 [KEB Method Selection]* setting will not have an effect.

**Note:**

- If you set *KEB Ride-Thru 1 [H1-xx = 65, 66]* and *KEB Ride-Thru 2 [H1-xx = 7A, 7B]* at the same time, the drive will detect *oPE03 [Multi-Function Input Setting Err]*.
- Refer to “KEB Ride-Thru function” for more information.

### ■ 7C: Short Circuit Braking (N.O.)

Setting	Function	Description
7C	Short Circuit Braking (N.O.)	<div style="display: flex; justify-content: space-between; align-items: center;"> <span>V/f</span> <span>CL-V/f</span> <span>OLV</span> <span>CLV</span> <span>AOLV</span> <span>OLV/PM</span> <span>AOLV/PM</span> <span>CLV/PM</span> <span>EZOLV</span> </div> Sets operation of Short Circuit Braking (N.O.).

If a three-phase PM motor short circuits, the drive will generate braking torque in the spinning motor. This will stop motor rotation and also prevent external forces from spinning the motor.

**Note:**

- When *A1-02 = 8 [Control Method Selection = EZ Open Loop Vector Control]*, this function is available if you use a PM motor.
- Refer to “b2: DC Circuit Braking” for more information.

**ON : Short Circuit Braking is enabled.**

**OFF : Normal operation**

### ■ 7D: Short Circuit Braking (N.C.)

Setting	Function	Description
7D	Short Circuit Braking (N.C.)	<div style="display: flex; justify-content: space-between; align-items: center;"> <span>V/f</span> <span>CL-V/f</span> <span>OLV</span> <span>CLV</span> <span>AOLV</span> <span>OLV/PM</span> <span>AOLV/PM</span> <span>CLV/PM</span> <span>EZOLV</span> </div> Sets operation of Short Circuit Braking (N.C.).

If a three-phase PM motor short circuits, the drive will generate braking torque in the spinning motor. This will stop motor rotation and also prevent external forces from spinning the motor.

**Note:**

- When *A1-02 = 8 [Control Method Selection = EZ Open Loop Vector Control]*, this function is available if you use a PM motor.
- Refer to “b2: DC Circuit Braking” for more information.

**ON : Normal operation**

**OFF : Short Circuit Braking is enabled.**

■ **7E: Reverse Rotation Identifier**

Setting	Function	Description
7E	Reverse Rotation Identifier	<div style="display: flex; justify-content: space-between; font-size: small;"> <span>V/f</span> <span>CL-V/f</span> <span>OLV</span> <span>CLV</span> <span>AOLV</span> <span>OLV/PM</span> <span>AOLV/PM</span> <span>CLV/PM</span> <span>EZOLV</span> </div> <p>Sets the rotation direction of the motor when in Simple Closed Loop V/f Control method and <math>F1-21, F1-37 = 0</math> [Encoder Option Function Selection = A pulse detection], or when in Closed Loop V/f Control method.</p>

**ON : Reverse**

Detects if the motor is rotating in the reverse direction.

**OFF : Forward**

Detects if the motor is rotating in the forward direction.

■ **7F: PID Bi-Directional Enable**

Setting	Function	Description
7F	PID Bi-Directional Enable	<div style="display: flex; justify-content: space-between; font-size: small;"> <span>V/f</span> <span>CL-V/f</span> <span>OLV</span> <span>CLV</span> <span>AOLV</span> <span>OLV/PM</span> <span>AOLV/PM</span> <span>CLV/PM</span> <span>EZOLV</span> </div> <p>Sets operation of the PID Bi-Directional function.</p>

**ON : Enabled**

**OFF : Disabled**

■ **90 to 97: DriveWorksEZ Digital Inputs 1 to 8**

Setting	Function	Description
90 to 97	DriveWorksEZ Digital Inputs 1 to 8	<div style="display: flex; justify-content: space-between; font-size: small;"> <span>V/f</span> <span>CL-V/f</span> <span>OLV</span> <span>CLV</span> <span>AOLV</span> <span>OLV/PM</span> <span>AOLV/PM</span> <span>CLV/PM</span> <span>EZOLV</span> </div> <p>Sets digital inputs used with DriveWorksEZ. Refer to the DriveWorksEZ Online Manual for more information.</p>

**Note:**

You cannot set values 90 to 97 for inverse output.

■ **9F: DWEZ Disable**

Setting	Function	Description
9F	DWEZ Disable	<div style="display: flex; justify-content: space-between; font-size: small;"> <span>V/f</span> <span>CL-V/f</span> <span>OLV</span> <span>CLV</span> <span>AOLV</span> <span>OLV/PM</span> <span>AOLV/PM</span> <span>CLV/PM</span> <span>EZOLV</span> </div> <p>Sets operation of the DriveWorksEZ program saved in the drive.</p>

**Note:**

Set  $A1-07 = 2$  [DriveWorksEZ Function Selection = Digital input] to use this function.

**ON : Disabled**

**OFF : Enabled**

■ **101 to 19F: Inverse Input of 1 to 9F**

Setting Value	Function	Description
101 to 19F	Inverse Input of 1 to 9F	Sets the function of the selected MFDI to operate inversely. To select the function, enter "1xx", where the "xx" is the function setting value.

For example, to use the inverse input of  $E$  [ASR Integral Reset], set  $H1-xx = 10E$ .

**Note:**

You cannot use inverse input for all functions. Refer to [Table 11.59](#) for more information.

◆ **H2: Multi-function Digital Output**

$H2$  parameters set the MFDO terminal functions.

■ **H2-01 to H2-03 Terminal M1-M2, M3-M4, M5-M6 Function Selection**

The drive has three MFDO terminals. [Table 11.64](#) shows the default function settings for the terminals.

Table 11.64 MFDO Terminals Default Function Settings

No.	Name	Default Setting	Function
H2-01	Term M1-M2 Function Selection	0	During Run
H2-02	Term M3-M4 Function Selection	1	Zero Speed
H2-03	Terminal M5-M6 Function Select	2	Speed Agree 1

Refer to Table 11.65 to set H2-xx [MFDO Function Select].

Table 11.65 MFDO Setting Value

Setting Value	Function	Setting Value	Function
0	During Run	22	Mechanical Weakening Detection
1	Zero Speed	2F	Maintenance Notification
2	Speed Agree 1	30	During Torque Limit
3	User-Set Speed Agree 1	31	During Speed Limit
4	Frequency Detection 1	32	In Speed Limit During Trq Ctrl
5	Frequency Detection 2	33	Zero Servo Complete
6	Drive Ready	37	During Frequency Output
7	DC Bus Undervoltage	38	Drive Enabled
8	During Baseblock (N.O.)	39	Watt Hour Pulse Output
9	Frequency Reference from Keypad	3C	LOCAL Control Selected
A	Run Command from Keypad	3D	During Speed Search
B	Torque Detection 1 (N.O.)	3E	PID Feedback Low
C	Frequency Reference Loss	3F	PID Feedback High
D	Braking Resistor Fault	4A	During KEB Ride-Thru
E	Fault	4B	During Short Circuit Braking
F *1	Not Used	4C	During Fast Stop
10	Alarm	4D	oH Pre-Alarm Reduction Limit
11	Fault Reset Command Active	4E *2	Braking Transistor Fault (rr)
12	Timer Output	4F *2	Braking Resistor Overheat (rH)
13	Speed Agree 2	60	Internal Cooling Fan Failure
14	User-Set Speed Agree 2	61	Pole Position Detection Complete
15	Frequency Detection 3	62	Modbus Reg 1 Status Satisfied
16	Frequency Detection 4	63	Modbus Reg 2 Status Satisfied
17	Torque Detection 1 (N.C.)	65	Standby Output
18	Torque Detection 2 (N.O.)	66	Comparator1
19	Torque Detection 2 (N.C.)	67	Comparator2
1A	During Reverse	69	External Power 24V Supply
1B	During Baseblock (N.C.)	90 to 93	DWEZ Digital Output 1 to 4
1C	Motor 2 Selected	A0 to A7	DWEZ Extended Digital Output 1 to 8
1D	During Regeneration	100 to 1A7	Inverse output of 0 to A7 Sets an inverse output of the function for the MFDO. Put a 1 at the front of the function setting to set inverse output. For example, set 138 for inverse output of 38 [Drive Enabled].
1E	Executing Auto-Restart		
1F	Motor Overload Alarm (oL1)		
20	Drive Overheat Pre-Alarm (oH)		
21	Safe Torque OFF		

\*1 Inverse output is not available.

\*2 You cannot set this parameter on models 2169 to 2415 and 4089 to 4675.

**■ Extend MFDO1 to MFDO3 Function Selection**

You can set MFDO functions to bit 0 to bit 2 [MEMOBUS MFDO1 to 3] of MEMOBUS register 15E0 (Hex.). Use H2-40 to H2-42 [Mbus Reg 15E0h bit0 to bit2 Output Func] to select the function.



Figure 11.88 Functional Block Diagram of MEMOBUS Multi-function Output

Table 11.66 MEMOBUS MFDO Registers

Register No. (Hex.)	Name	
15E0	bit0	MEMOBUS MFDO 1
	bit1	MEMOBUS MFDO 2
	bit2	MEMOBUS MFDO 3

**Note:**

- Refer to H2-xx “MFDO Setting Values” for more information about MFDO setting values.
- When you do not set functions to H2-40 to H2-42, set them to F.

**■ Output of Logical Operation Results of MFDO**

This enables the logical operation results of two MFDOs to be output to one MFDO terminal.

Use H2-60, H2-63, and H2-66 [Term M1-M2 Secondary Function to Term M5-M6 Secondary Function] to set the function of the output signal for which logical operations are performed.

Use H2-61, H2-64, H2-67 [Terminal M1-M2 Logical Operation to Terminal M5-M6 Logical Operation] to set the logical operation.

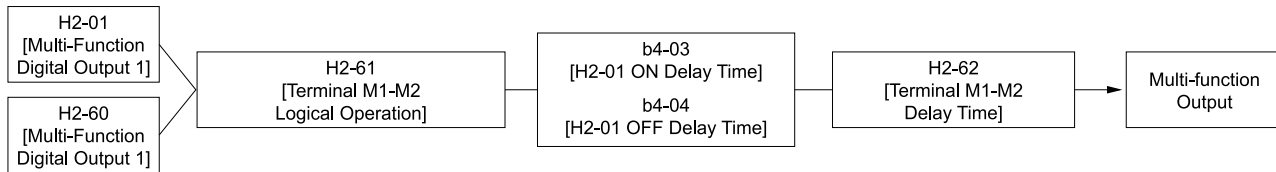


Figure 11.89 Functional Block Diagram of Logical Operation Output for MFDO 1

Table 11.67 MFDO Logical Operation Table

Logical Operation Selection	Logical Operation Expression	Logical Operation Notation
H2-61, H2-64, H2-67		
0	$A=B=1$	
1	$A=1 \text{ or } B=1$	
2	$A=0 \text{ or } B=0$	
3	$A=B=0$	
4	$A=B$	$A=B$
5	$A \neq B$	
6	$AND(A, \bar{B})$	
7	$OR(A, \bar{B})$	
8	-	On



**Note:**

- If you use the function to output logical calculation results, you cannot set  $H2-01$  to  $H2-03 = 1xx$  [Inverse Output of  $xx$ ]. If you do, the drive will detect  $oPE33$  [Digital Output Selection Error].
- You cannot set  $0$  [3-Wire Sequence] and  $20$  to  $2F$  [External Fault] for  $H2-60$ ,  $H2-63$ , and  $H2-66$ .
- When you do not use  $H2-60$ ,  $H2-63$ , and  $H2-66$ , set them to  $F$ . The Through Mode function is not supported.

## ◆ H2 MFDO Parameters

### ■ H2-01: Term M1-M2 Function Selection

No. (Hex.)	Name	Description	Default (Range)
H2-01 (040B)	Term M1-M2 Function Selection	<div style="display: flex; justify-content: space-between; font-size: 0.8em; font-weight: bold;"> <span>V/f</span> <span>CL-V/f</span> <span>OLV</span> <span>CLV</span> <span>AOLV</span> <span>OLV/PM</span> <span>AOLV/PM</span> <span>CLV/PM</span> <span>EZOLV</span> </div> Sets the function for MFDO terminal M1-M2.	0 (0 - 1A7)

**Note:**

Set this parameter to  $F$  when not using the terminal or to use the terminal in through mode.

### ■ H2-02: Term M3-M4 Function Selection

No. (Hex.)	Name	Description	Default (Range)
H2-02 (040C)	Term M3-M4 Function Selection	<div style="display: flex; justify-content: space-between; font-size: 0.8em; font-weight: bold;"> <span>V/f</span> <span>CL-V/f</span> <span>OLV</span> <span>CLV</span> <span>AOLV</span> <span>OLV/PM</span> <span>AOLV/PM</span> <span>CLV/PM</span> <span>EZOLV</span> </div> Sets the function for MFDO terminal M3-M4.	1 (0 - 1A7)

**Note:**

Set this parameter to  $F$  when not using the terminal or to use the terminal in through mode.

### ■ H2-03: Term M5-M6 Function Selection

No. (Hex.)	Name	Description	Default (Range)
H2-03 (040D)	Term M5-M6 Function Selection	<div style="display: flex; justify-content: space-between; font-size: 0.8em; font-weight: bold;"> <span>V/f</span> <span>CL-V/f</span> <span>OLV</span> <span>CLV</span> <span>AOLV</span> <span>OLV/PM</span> <span>AOLV/PM</span> <span>CLV/PM</span> <span>EZOLV</span> </div> Sets the function for MFDO terminal M5-M6.	2 (0 - 1A7)

**Note:**

Set this parameter to  $F$  when not using the terminal or to use the terminal in through mode.

### ■ H2-06: Watt Hour Output Unit Selection

No. (Hex.)	Name	Description	Default (Range)
H2-06 (0437)	Watt Hour Output Unit Selection	<div style="display: flex; justify-content: space-between; font-size: 0.8em; font-weight: bold;"> <span>V/f</span> <span>CL-V/f</span> <span>OLV</span> <span>CLV</span> <span>AOLV</span> <span>OLV/PM</span> <span>AOLV/PM</span> <span>CLV/PM</span> <span>EZOLV</span> </div> Sets the unit for the output signal when $H2-01$ to $H2-03 = 39$ [MFDO Function Select = Watt Hour Pulse Output].	0 (0 - 4)

This output is input to the Watt hour meter or PLC through a 200 ms pulse signal. This parameter sets the kWh unit for each pulse output.

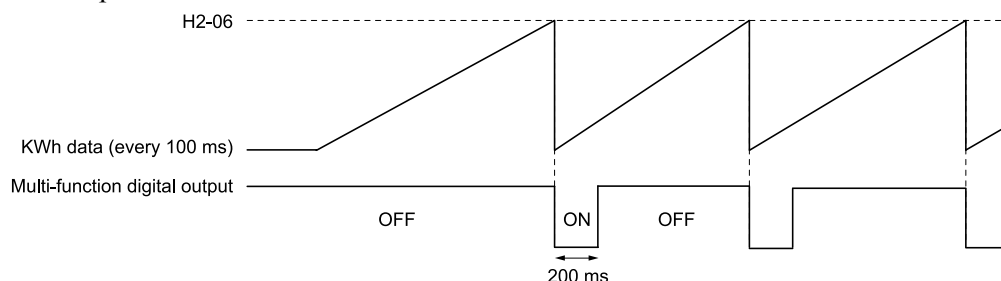


Figure 11.90 Example MFDO when Configured for Watt Hours

**Note:**

- When the power value is a negative value (regenerative state), the drive does not count Watt hours.
- When the control power supply to the drive is operating, the drive will keep the Watt hours. If a momentary power loss causes the drive to lose control power, the Watt hour count will reset.

0 : 0.1 kWh units

1 : 1 kWh units

2 : 10 kWh units

3 : 100 kWh units

4 : 1000 kWh units

### ■ H2-07: Modbus Register 1 Address Select

No. (Hex.)	Name	Description	Default (Range)
H2-07 (0B3A)	Modbus Register 1 Address Select	<div style="display: flex; justify-content: space-between; font-size: 0.8em; font-weight: bold;"> <span>V/f</span> <span>CL-V/f</span> <span>OLV</span> <span>CLV</span> <span>AOLV</span> <span>OLV/PM</span> <span>AOLV/PM</span> <span>CLV/PM</span> <span>EZOLV</span> </div> Sets the address of the MEMOBUS/Modbus register output to the MFDO terminal.	0001 (0001 - 1FFF)

Configures *H2-07* with the address of the register that is output to *Modbus Reg 1 Status Satisfied [H2-01 to H2-03 = 62]* and configures *H2-08* with the bit.

### ■ H2-08: Modbus Register 1 Bit Select

No. (Hex.)	Name	Description	Default (Range)
H2-08 (0B3B)	Modbus Register 1 Bit Select	<div style="display: flex; justify-content: space-between; font-size: 0.8em; font-weight: bold;"> <span>V/f</span> <span>CL-V/f</span> <span>OLV</span> <span>CLV</span> <span>AOLV</span> <span>OLV/PM</span> <span>AOLV/PM</span> <span>CLV/PM</span> <span>EZOLV</span> </div> Sets the bit of the MEMOBUS/Modbus register output to the MFDO terminal.	0000 (0000 - FFFF)

Sets the bit of the register that is output to *Modbus Reg 1 Status Satisfied [H2-01 to H2-03 = 62]* and uses the address in *H2-07 [Modbus Register 1 Address Select]*.

### ■ H2-09: Modbus Register 2 Address Select

No. (Hex.)	Name	Description	Default (Range)
H2-09 (0B3C)	Modbus Register 2 Address Select	<div style="display: flex; justify-content: space-between; font-size: 0.8em; font-weight: bold;"> <span>V/f</span> <span>CL-V/f</span> <span>OLV</span> <span>CLV</span> <span>AOLV</span> <span>OLV/PM</span> <span>AOLV/PM</span> <span>CLV/PM</span> <span>EZOLV</span> </div> Sets the address of the MEMOBUS/Modbus register output to the MFDO terminal.	0001 (0001 - 1FFF)

Sets *H2-09* with the address of the register that is output to *Modbus Reg 2 Status Satisfied [H2-01 to H2-03 = 63]* and uses the bit in *H2-10 [Modbus Register 2 Bit Select]*.

### ■ H2-10: Modbus Register 2 Bit Select

No. (Hex.)	Name	Description	Default (Range)
H2-10 (0B3D)	Modbus Register 2 Bit Select	<div style="display: flex; justify-content: space-between; font-size: 0.8em; font-weight: bold;"> <span>V/f</span> <span>CL-V/f</span> <span>OLV</span> <span>CLV</span> <span>AOLV</span> <span>OLV/PM</span> <span>AOLV/PM</span> <span>CLV/PM</span> <span>EZOLV</span> </div> Sets the bit of the MEMOBUS/Modbus register output to the MFDO terminal.	0000 (0000 - FFFF)

Sets the bit of the register that is output to *Modbus Reg 2 Status Satisfied [H2-01 to H2-03 = 63]* and uses the address in *H2-09*.

### ■ H2-20: Comparator 1 Monitor Selection

No. (Hex.)	Name	Description	Default (Range)
H2-20 (1540)	Comparator 1 Monitor Selection	<div style="display: flex; justify-content: space-between; font-size: 0.8em; font-weight: bold;"> <span>V/f</span> <span>CL-V/f</span> <span>OLV</span> <span>CLV</span> <span>AOLV</span> <span>OLV/PM</span> <span>AOLV/PM</span> <span>CLV/PM</span> <span>EZOLV</span> </div> Sets the monitor number for comparator 1. Set the <i>x-xx</i> part of the <i>Ux-xx [Monitor]</i> . For example, set <i>x-xx</i> to 102 to monitor <i>U1-02 [Output Frequency]</i> .	102 (000 - 999)

**Note:**

- Refer to *H2-xx = 66 and 67 [MFDO Function Select = Comparator1 and Comparator2]* for more information about the comparator function.
- The configurable monitor changes when the control method changes.

### ■ H2-21: Comparator 1 Lower Limit

No. (Hex.)	Name	Description	Default (Range)
H2-21 (1541)	Comparator 1 Lower Limit	<div style="display: flex; justify-content: space-between; font-size: 0.8em; font-weight: bold; margin-bottom: 5px;"> <span>V/f</span> <span>CL-V/f</span> <span>OLV</span> <span>CLV</span> <span>AOLV</span> <span>OLV/PM</span> <span>AOLV/PM</span> <span>CLV/PM</span> <span>EZOLV</span> </div> Sets the lower limit detection level for comparator 1 when the full scale analog output for the monitor selected in H2-20 [Comparator 1 Monitor Selection] is the 100% value.	0.0% (0.0 - 300.0%)

**Note:**

Refer to H2-xx = 66 and 67 [MFDO Function Select = Comparator1 and Comparator2] for more information about the comparator function.

### ■ H2-22: Comparator 1 Upper Limit

No. (Hex.)	Name	Description	Default (Range)
H2-22 (1542)	Comparator 1 Upper Limit	<div style="display: flex; justify-content: space-between; font-size: 0.8em; font-weight: bold; margin-bottom: 5px;"> <span>V/f</span> <span>CL-V/f</span> <span>OLV</span> <span>CLV</span> <span>AOLV</span> <span>OLV/PM</span> <span>AOLV/PM</span> <span>CLV/PM</span> <span>EZOLV</span> </div> Sets the upper limit detection level for comparator 1 when the full scale analog output for the monitor selected in H2-20 [Comparator 1 Monitor Selection] is the 100% value.	0.0% (0.0 - 300.0%)

**Note:**

Refer to H2-xx = 66 and 67 [MFDO Function Select = Comparator1 and Comparator2] for more information about the comparator function.

### ■ H2-23: Comparator 1 Hysteresis

No. (Hex.)	Name	Description	Default (Range)
H2-23 (1543)	Comparator 1 Hysteresis	<div style="display: flex; justify-content: space-between; font-size: 0.8em; font-weight: bold; margin-bottom: 5px;"> <span>V/f</span> <span>CL-V/f</span> <span>OLV</span> <span>CLV</span> <span>AOLV</span> <span>OLV/PM</span> <span>AOLV/PM</span> <span>CLV/PM</span> <span>EZOLV</span> </div> Sets the hysteresis level for comparator 1 when the full scale analog output for the monitor selected in H2-20 [Comparator 1 Monitor Selection] is the 100% value.	0.0% (0.0 - 10.0%)

**Note:**

Refer to H2-xx = 66 and 67 [MFDO Function Select = Comparator1 and Comparator2] for more information about the comparator function.

### ■ H2-24: Comparator 1 On-Delay Time

No. (Hex.)	Name	Description	Default (Range)
H2-24 (1544)	Comparator 1 On-Delay Time	<div style="display: flex; justify-content: space-between; font-size: 0.8em; font-weight: bold; margin-bottom: 5px;"> <span>V/f</span> <span>CL-V/f</span> <span>OLV</span> <span>CLV</span> <span>AOLV</span> <span>OLV/PM</span> <span>AOLV/PM</span> <span>CLV/PM</span> <span>EZOLV</span> </div> Sets the on-delay time for comparator 1.	0.0 s (0.0 - 600.0 s)

**Note:**

Refer to H2-xx = 66 and 67 [MFDO Function Select = Comparator1 and Comparator2] for more information about the comparator function.

### ■ H2-25: Comparator 1 Off-Delay Time

No. (Hex.)	Name	Description	Default (Range)
H2-25 (1545)	Comparator 1 Off-Delay Time	<div style="display: flex; justify-content: space-between; font-size: 0.8em; font-weight: bold; margin-bottom: 5px;"> <span>V/f</span> <span>CL-V/f</span> <span>OLV</span> <span>CLV</span> <span>AOLV</span> <span>OLV/PM</span> <span>AOLV/PM</span> <span>CLV/PM</span> <span>EZOLV</span> </div> Sets the off-delay time for comparator 1.	0.0 s (0.0 - 600.0 s)

**Note:**

Refer to H2-xx = 66 and 67 [MFDO Function Select = Comparator1 and Comparator2] for more information about the comparator function.

### ■ H2-26: Comparator 2 Monitor Selection

No. (Hex.)	Name	Description	Default (Range)
H2-26 (1546)	Comparator 2 Monitor Selection	<div style="display: flex; justify-content: space-between; font-size: 0.8em; font-weight: bold; margin-bottom: 5px;"> <span>V/f</span> <span>CL-V/f</span> <span>OLV</span> <span>CLV</span> <span>AOLV</span> <span>OLV/PM</span> <span>AOLV/PM</span> <span>CLV/PM</span> <span>EZOLV</span> </div> Sets the monitor number for comparator 2. Set the <i>x-xx</i> part of the <i>Ux-xx [Monitor]</i> . For example, set <i>x-xx</i> to 102 to monitor <i>U1-02 [Output Frequency]</i> .	103 (000 - 999)

**Note:**

- The configurable monitor changes when the control method changes.
- To use in through mode, set this parameter to *000* or *031*. You can set the terminal output level from the PLC through MEMOBUS/Modbus communications or the communication option.
- Refer to *H2-xx = 66 and 67 [MFDO Function Select = Comparator1 and Comparator2]* for more information about the comparator function.

### ■ H2-27: Comparator 2 Lower Limit

No. (Hex.)	Name	Description	Default (Range)
H2-27 (1547)	Comparator 2 Lower Limit	<div style="display: flex; justify-content: space-between; font-size: 0.8em; font-weight: bold; margin-bottom: 5px;"> <span>V/f</span> <span>CL-V/f</span> <span>OLV</span> <span>CLV</span> <span>AOLV</span> <span>OLV/PM</span> <span>AOLV/PM</span> <span>CLV/PM</span> <span>EZOLV</span> </div> Sets the lower limit detection level for comparator 1 when the full scale analog output for the monitor selected in <i>H2-26 [Comparator 2 Monitor Selection]</i> is the 100% value.	0.0% (0.0 - 300.0%)

**Note:**

Refer to *H2-xx = 66 and 67 [MFDO Function Select = Comparator1 and Comparator2]* for more information about the comparator function.

### ■ H2-28: Comparator 2 Upper Limit

No. (Hex.)	Name	Description	Default (Range)
H2-28 (1548)	Comparator 2 Upper Limit	<div style="display: flex; justify-content: space-between; font-size: 0.8em; font-weight: bold; margin-bottom: 5px;"> <span>V/f</span> <span>CL-V/f</span> <span>OLV</span> <span>CLV</span> <span>AOLV</span> <span>OLV/PM</span> <span>AOLV/PM</span> <span>CLV/PM</span> <span>EZOLV</span> </div> Sets the upper limit detection level for comparator 1 when the full scale analog output for the monitor selected in <i>H2-26 [Comparator 2 Monitor Selection]</i> is the 100% value.	0.0% (0.0 - 300.0%)

**Note:**

Refer to *H2-xx = 66 and 67 [MFDO Function Select = Comparator1 and Comparator2]* for more information about the comparator function.

### ■ H2-29: Comparator 2 Hysteresis

No. (Hex.)	Name	Description	Default (Range)
H2-29 (1549)	Comparator 2 Hysteresis	<div style="display: flex; justify-content: space-between; font-size: 0.8em; font-weight: bold; margin-bottom: 5px;"> <span>V/f</span> <span>CL-V/f</span> <span>OLV</span> <span>CLV</span> <span>AOLV</span> <span>OLV/PM</span> <span>AOLV/PM</span> <span>CLV/PM</span> <span>EZOLV</span> </div> Sets the hysteresis level for comparator 2 when the full scale analog output for the monitor selected in <i>H2-26 [Comparator 2 Monitor Selection]</i> is the 100% value.	0.0% (0.0 - 10.0%)

**Note:**

Refer to *H2-xx = 66 and 67 [Multi-Function Digital Out Function Select = Comparator1 and Comparator 2]* for more information about the comparator function.

### ■ H2-30: Comparator 2 On-Delay Time

No. (Hex.)	Name	Description	Default (Range)
H2-30 (154A)	Comparator 2 On-Delay Time	<div style="display: flex; justify-content: space-between; font-size: 0.8em; font-weight: bold; margin-bottom: 5px;"> <span>V/f</span> <span>CL-V/f</span> <span>OLV</span> <span>CLV</span> <span>AOLV</span> <span>OLV/PM</span> <span>AOLV/PM</span> <span>CLV/PM</span> <span>EZOLV</span> </div> Sets the on-delay time for comparator 2.	0.0 s (0.0 - 600.0 s)

**Note:**

Refer to *H2-xx = 66 and 67 [Multi-Function Digital Out Function Select = Comparator 1 and Comparator 2]* for more information about the comparator function.

### ■ H2-31: Comparator 2 Off-Delay Time

No. (Hex.)	Name	Description	Default (Range)
H2-31 (154B)	Comparator 2 Off-Delay Time	<b>V/f</b> <b>CL-V/f</b> <b>OLV</b> <b>CLV</b> <b>AOLV</b> <b>OLV/PM</b> <b>AOLV/PM</b> <b>CLV/PM</b> <b>EZOLV</b> Sets the off-delay time for comparator 2.	0.0 s (0.0 - 600.0 s)

**Note:**

Refer to H2-xx = 66 and 67 [MFDO Function Select = Comparator1 and Comparator2] for more information about the comparator function.

### ■ H2-32: Comparator 1 Filter Time

No. (Hex.)	Name	Description	Default (Range)
H2-32 (159A)	Comparator 1 Filter Time	<b>V/f</b> <b>CL-V/f</b> <b>OLV</b> <b>CLV</b> <b>AOLV</b> <b>OLV/PM</b> <b>AOLV/PM</b> <b>CLV/PM</b> <b>EZOLV</b> Sets the time constant that is applied to the primary delay filter used for the analog output of the monitor selected with H2-20 [Comparator 1 Monitor Selection].	0.0s (0.0 - 10.0 s)

### ■ H2-33: Comparator1 Protection Selection

No. (Hex.)	Name	Description	Default (Range)
H2-33 (159B)	Comparator1 Protection Selection	<b>V/f</b> <b>CL-V/f</b> <b>OLV</b> <b>CLV</b> <b>AOLV</b> <b>OLV/PM</b> <b>AOLV/PM</b> <b>CLV/PM</b> <b>EZOLV</b> Sets drive operation when it detects CP1 [Comparator1 Limit Fault].	4 (0 - 4)

#### 0 : Ramp to Stop

The drive ramps to stop in the set deceleration time. Fault relay output terminal MA-MC activates and terminal MB-MC deactivates.

#### 1 : Coast to Stop

The drive output shuts off and the motor coasts to stop. Fault relay output terminal MA-MC activates and terminal MB-MC deactivates.

#### 2 : Fast Stop (Use C1-09)

The drive stops the motor in the deceleration time set in C1-09 [Fast Stop Time]. Fault relay output terminal MA-MC activates and terminal MB-MC deactivates.

#### 3 : Alarm Only

The keypad shows “CP1” and the drive continues operation at the current frequency reference.

**Note:**

The output terminal set for Alarm [H2-01 to H2-03 = 10] activates.

#### 4 : Digital Output Only

### ■ H2-34: Comparator 2 Filter Time

No. (Hex.)	Name	Description	Default (Range)
H2-34 (159C)	Comparator 2 Filter Time	<b>V/f</b> <b>CL-V/f</b> <b>OLV</b> <b>CLV</b> <b>AOLV</b> <b>OLV/PM</b> <b>AOLV/PM</b> <b>CLV/PM</b> <b>EZOLV</b> Sets the time constant that is applied to the primary delay filter used for the analog output of the monitor selected with H2-26 [Comparator 2 Monitor Selection].	0.0s (0.0 - 10.0 s)

### ■ H2-35: Comparator2 Protection Selection

No. (Hex.)	Name	Description	Default (Range)
H2-35 (159D)	Comparator2 Protection Selection	<b>V/f</b> <b>CL-V/f</b> <b>OLV</b> <b>CLV</b> <b>AOLV</b> <b>OLV/PM</b> <b>AOLV/PM</b> <b>CLV/PM</b> <b>EZOLV</b> Sets drive operation when it detects CP2 [Comparator2 Limit Fault].	4 (0 - 4)

#### 0 : Ramp to Stop

The drive ramps to stop in the set deceleration time. Fault relay output terminal MA-MC activates and terminal MB-MC deactivates.

**1 : Coast to Stop**

The drive output shuts off and the motor coasts to stop. Fault relay output terminal MA-MC activates and terminal MB-MC deactivates.

**2 : Fast Stop (Use C1-09)**

The drive stops the motor in the deceleration time set in *C1-09 [Fast Stop Time]*. Fault relay output terminal MA-MC activates and terminal MB-MC deactivates.

**3 : Alarm Only**

The keypad shows “CP2” and the drive continues operation at the current frequency reference.

**Note:**

The output terminal set for Alarm [*H2-01 to H2-03 = 10*] activates.

**4 : Digital Output Only**

**■ H2-36: Comparator 1 Ineffective Time**

No. (Hex.)	Name	Description	Default (Range)
H2-36 (159E)	Comparator 1 Ineffective Time	<b>V/f</b> <b>CL-V/f</b> <b>OLV</b> <b>CLV</b> <b>AOLV</b> <b>OLV/IPM</b> <b>AOLV/IPM</b> <b>CLV/IPM</b> <b>EZOLV</b> Sets the length of time that <i>CP1 [Comparator1 Limit Fault]</i> is disabled.	0.0 s (0.0 - 10.0 s)

**Note:**

- After you enter a Run command and wait for the time set in this parameter, the drive will monitor operation and make sure that it is in the Comparator 1 range until you enter the Stop command.
- When *CP1* detection is disabled, the drive will trigger a digital output.

**■ H2-37: Comparator 2 Ineffective Time**

No. (Hex.)	Name	Description	Default (Range)
H2-37 (159F)	Comparator 2 Ineffective Time	<b>V/f</b> <b>CL-V/f</b> <b>OLV</b> <b>CLV</b> <b>AOLV</b> <b>OLV/IPM</b> <b>AOLV/IPM</b> <b>CLV/IPM</b> <b>EZOLV</b> Sets the length of time that <i>CP2 [Comparator2 Limit Fault]</i> is disabled.	0.0 s (0.0 - 10.0 s)

**Note:**

- After you enter a Run command and wait for the time set in this parameter, the drive will monitor operation and make sure that it is in the Comparator 2 range until you enter the Stop command.
- When *CP2* detection is disabled, the drive will trigger a digital output.

**■ H2-40: Mbus Reg 15E0h bit0 Output Func**

No. (Hex.)	Name	Description	Default (Range)
H2-40 (0B58)	Mbus Reg 15E0h bit0 Output Func	<b>V/f</b> <b>CL-V/f</b> <b>OLV</b> <b>CLV</b> <b>AOLV</b> <b>OLV/IPM</b> <b>AOLV/IPM</b> <b>CLV/IPM</b> <b>EZOLV</b> Sets the MFDO for bit 0 of MEMOBUS register 15E0 (Hex.).	F (0 - 1A7)

**■ H2-41: Mbus Reg 15E0h bit1 Output Func**

No. (Hex.)	Name	Description	Default (Range)
H2-41 (0B59)	Mbus Reg 15E0h bit1 Output Func	<b>V/f</b> <b>CL-V/f</b> <b>OLV</b> <b>CLV</b> <b>AOLV</b> <b>OLV/IPM</b> <b>AOLV/IPM</b> <b>CLV/IPM</b> <b>EZOLV</b> Sets the MFDO for bit 1 of MEMOBUS register 15E0 (Hex.).	F (0 - 1A7)

**■ H2-42: Mbus Reg 15E0h bit2 Output Func**

No. (Hex.)	Name	Description	Default (Range)
H2-42 (0B5A)	Mbus Reg 15E0h bit2 Output Func	<b>V/f</b> <b>CL-V/f</b> <b>OLV</b> <b>CLV</b> <b>AOLV</b> <b>OLV/IPM</b> <b>AOLV/IPM</b> <b>CLV/IPM</b> <b>EZOLV</b> Sets the MFDO for bit 2 of MEMOBUS register 15E0 (Hex.).	F (0 - 1A7)

### ■ H2-60: Term M1-M2 Secondary Function

No. (Hex.)	Name	Description	Default (Range)
H2-60 (1B46) Expert	Term M1-M2 Secondary Function	<b>V/f</b> <b>CL-V/f</b> <b>OLV</b> <b>CLV</b> <b>AOLV</b> <b>OLV/PM</b> <b>AOLV/PM</b> <b>CLV/PM</b> <b>EZOLV</b> Selects the second function for terminal M1-M2. The logical calculation results of the terminals assigned to functions by H2-01 [Term M1-M2 Function Selection] is output.	F (0 - A7)

### ■ H2-61: Terminal M1-M2 Logical Operation

No. (Hex.)	Name	Description	Default (Range)
H2-61 (1B47) Expert	Terminal M1-M2 Logical Operation	<b>V/f</b> <b>CL-V/f</b> <b>OLV</b> <b>CLV</b> <b>AOLV</b> <b>OLV/PM</b> <b>AOLV/PM</b> <b>CLV/PM</b> <b>EZOLV</b> Sets the logical operation for the functions set in H2-01 [Term M1-M2 Function Selection] and H2-60 [Term M1-M2 Secondary Function].	0 (0 - 8)

**Note:**

Refer to [Output of Logical Operation Results of MFDO on page 888](#) for more information about the relation between parameter settings and logical operations.

### ■ H2-62: Terminal M1-M2 Delay Time

No. (Hex.)	Name	Description	Default (Range)
H2-62 (1B48) Expert	Terminal M1-M2 Delay Time	<b>V/f</b> <b>CL-V/f</b> <b>OLV</b> <b>CLV</b> <b>AOLV</b> <b>OLV/PM</b> <b>AOLV/PM</b> <b>CLV/PM</b> <b>EZOLV</b> Sets the minimum on time used to output the logical calculation results from terminal M1-M2.	0.1 s (0.0 - 25.0 s)

### ■ H2-63: Term M3-M4 Secondary Function

No. (Hex.)	Name	Description	Default (Range)
H2-63 (1B49) Expert	Term M3-M4 Secondary Function	<b>V/f</b> <b>CL-V/f</b> <b>OLV</b> <b>CLV</b> <b>AOLV</b> <b>OLV/PM</b> <b>AOLV/PM</b> <b>CLV/PM</b> <b>EZOLV</b> Selects the second function for terminal M3-M4. The logical calculation results of the terminals assigned to functions by H2-02 [Term M3-M4 Function Selection] is output.	F (0 - A7)

### ■ H2-64: Terminal M3-M4 Logical Operation

No. (Hex.)	Name	Description	Default (Range)
H2-64 (1B4A) Expert	Terminal M3-M4 Logical Operation	<b>V/f</b> <b>CL-V/f</b> <b>OLV</b> <b>CLV</b> <b>AOLV</b> <b>OLV/PM</b> <b>AOLV/PM</b> <b>CLV/PM</b> <b>EZOLV</b> Sets the logical operation for the functions set in H2-02 [Term M3-M4 Function Selection] and H2-63 [Term M3-M4 Secondary Function].	0 (0 - 8)

**Note:**

Refer to [Output of Logical Operation Results of MFDO on page 888](#) for more information about the relation between parameter settings and logical operations.

### ■ H2-65: Terminal M3-M4 Delay Time

No. (Hex.)	Name	Description	Default (Range)
H2-65 (1B4B) Expert	Terminal M3-M4 Delay Time	<b>V/f</b> <b>CL-V/f</b> <b>OLV</b> <b>CLV</b> <b>AOLV</b> <b>OLV/PM</b> <b>AOLV/PM</b> <b>CLV/PM</b> <b>EZOLV</b> Sets the minimum on time used to output the logical calculation results from terminal M3-M4.	0.1 s (0.0 - 25.0 s)

■ **H2-66: Term M5-M6 Secondary Function**

No. (Hex.)	Name	Description	Default (Range)
H2-66 (1B4C) Expert	Term M5-M6 Secondary Function	<span>V/f</span> <span>CL-V/f</span> <span>OLV</span> <span>CLV</span> <span>AOLV</span> <span>OLV/PM</span> <span>AOLV/PM</span> <span>CLV/PM</span> <span>EZOLV</span> Selects the second function for terminal M5-M6. The logical calculation results of the terminals assigned to functions by H2-03 [Term M5-M6 Function Selection] is output.	F (0 - A7)

■ **H2-67: Terminal M5-M6 Logical Operation**

No. (Hex.)	Name	Description	Default (Range)
H2-67 (1B4D) Expert	Terminal M5-M6 Logical Operation	<span>V/f</span> <span>CL-V/f</span> <span>OLV</span> <span>CLV</span> <span>AOLV</span> <span>OLV/PM</span> <span>AOLV/PM</span> <span>CLV/PM</span> <span>EZOLV</span> Sets the logical operation for the functions set in H2-03 [Term M5-M6 Function Selection] and H2-66 [Term M5-M6 Secondary Function].	0 (0 - 8)

**Note:**

Refer to *Output of Logical Operation Results of MFDO on page 888* for more information about the relation between parameter settings and logical operations.

■ **H2-68: Terminal M5-M6 Delay Time**

No. (Hex.)	Name	Description	Default (Range)
H2-68 (1B4E) Expert	Terminal M5-M6 Delay Time	<span>V/f</span> <span>CL-V/f</span> <span>OLV</span> <span>CLV</span> <span>AOLV</span> <span>OLV/PM</span> <span>AOLV/PM</span> <span>CLV/PM</span> <span>EZOLV</span> Sets the minimum on time used to output the logical calculation results from terminal M5-M6.	0.1 s (0.0 - 25.0 s)

◆ **MFDO Setting Value**

Selects the function configured to MFDO.

■ **0: During Run**

Setting	Function	Description
0	During Run	<span>V/f</span> <span>CL-V/f</span> <span>OLV</span> <span>CLV</span> <span>AOLV</span> <span>OLV/PM</span> <span>AOLV/PM</span> <span>CLV/PM</span> <span>EZOLV</span> The terminal activates when the Run command is input and when the drive is making voltage.

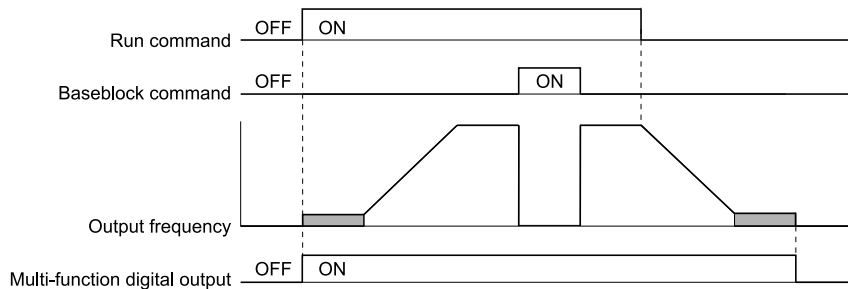


Figure 11.91 Drive Running Time Chart

**ON : Drive is running**

Drive is operating or making voltage.

**OFF : Drive is stopping**

Drive is stopped.

■ **1: Zero Speed**

Setting	Function	Description
1	Zero Speed	<span>V/f</span> <span>CL-V/f</span> <span>OLV</span> <span>CLV</span> <span>AOLV</span> <span>OLV/PM</span> <span>AOLV/PM</span> <span>CLV/PM</span> <span>EZOLV</span> The terminal activates when the output frequency is less than the value of E1-09 [Minimum Output Frequency] or b2-01 [DC Injection/Zero SpeedThreshold].



**Note:**

A1-02 [Control Method Selection] selects which parameter is the reference.

A1-02 Setting	Control Method	Parameter Used as the Reference
0	V/f Control	E1-09
1	Closed Loop V/f Control	E1-09
2	Open Loop Vector Control	b2-01
3	Closed Loop Vector Control	E1-09
4	Advanced OpenLoop Vector Control	E1-09
5	PM Open Loop Vector Control	E1-09
6	PM Advanced Open Loop Vector	E1-09
7	PM Closed Loop Vector Control	b2-01
8	EZ Open Loop Vector Control	E1-09

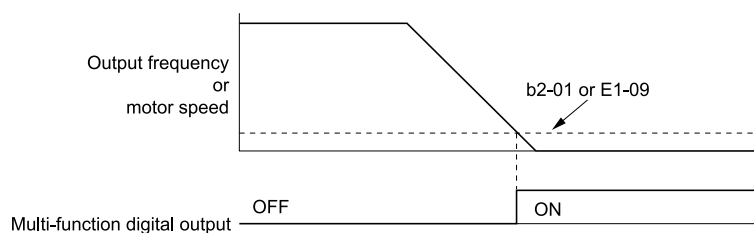


Figure 11.92 Zero Speed Time Chart

**ON :** Output frequency < value of E1-09 or b2-01.

**OFF :** Output frequency ≥ value of E1-09 or b2-01.

■ **2: Speed Agree 1**

Setting	Function	Description
2	Speed Agree 1	<p>V/f CL-V/f OLV CLV AOLV OLV/PM AOLV/PM CLV/PM EZOLV</p> <p>The terminal turns on when the output frequency is in the range of the frequency reference ± L4-02 [Speed Agree Detection Width].</p>

**Note:**

- The motor rotation direction does not have an effect on the detection function.
- CLV control uses motor speed as the reference.

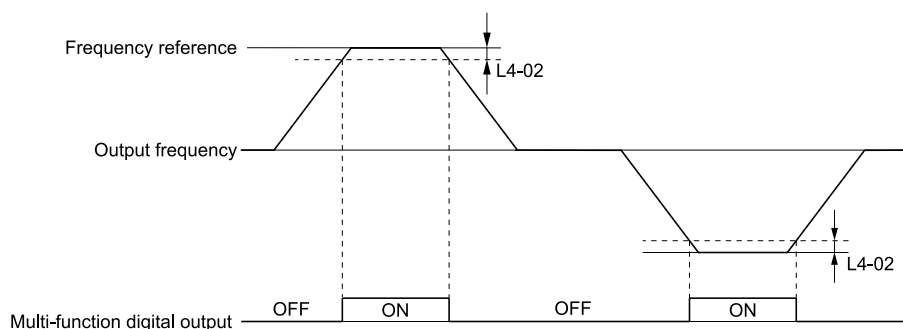


Figure 11.93 Speed Agree 1 Time Chart

**ON :** The output frequency is in the range of “frequency reference ± L4-02.”

**OFF :** The output frequency does not align with the frequency reference although the drive is running.

■ **3: User-Set Speed Agree 1**

Setting	Function	Description
3	User-Set Speed Agree 1	<p>V/f CL-V/f OLV CLV AOLV OLV/PM AOLV/PM CLV/PM EZOLV</p> <p>The terminal activates when the output frequency is in the range of L4-01 [Speed Agree Detection Level] ± L4-02 [Speed Agree Detection Width] and in the range of the frequency reference ± L4-02.</p>

**Note:**

- The motor rotation direction does not have an effect on the detection function. The drive uses the *L4-01* value as the forward/reverse detection level.
- CLV control uses motor speed as the reference.

**ON :** The output frequency is in the range of “*L4-01 ± L4-02*” and the range of frequency reference  $\pm L4-02$ .

**OFF :** The output frequency is not in the range of “*L4-01 ± L4-02*” or the in the range of frequency reference  $\pm L4-02$ .

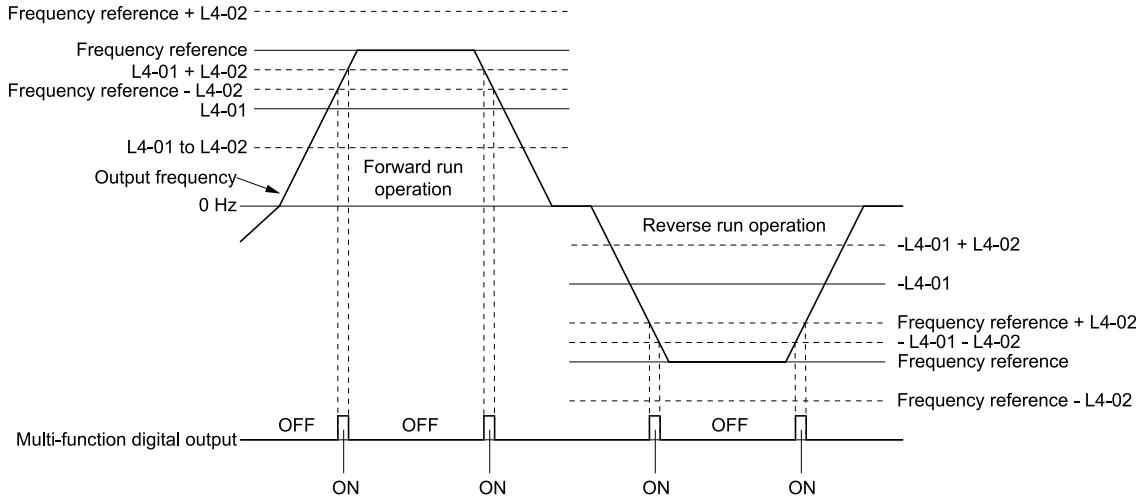


Figure 11.94 User-Defined Speed Agree 1 Time Chart

■ 4: Frequency Detection 1

Setting	Function	Description
4	Frequency Detection 1	<p><b>V/f</b> <b>CL-V/f</b> <b>OLV</b> <b>CLV</b> <b>AOLV</b> <b>OLV/PM</b> <b>AOLV/PM</b> <b>CLV/PM</b> <b>EZOLV</b></p> <p>The terminal activates when the output frequency is higher than the value of <i>L4-01</i> [Speed Agree Detection Level] + <i>L4-02</i> [Speed Agree Detection Width]. After the terminal deactivates, the terminal stays off until the output frequency is at the level set with <i>L4-01</i>.</p>

**Note:**

- The motor rotation direction does not have an effect on the detection function. The drive uses the *L4-01* value as the forward/reverse detection level.
- CLV control uses motor speed as the reference.

**ON :** The output frequency is less than the value of *L4-01* or is not more than the value of *L4-01 + L4-02*.

**OFF :** The output frequency is higher than the value of *L4-01 + L4-02*.

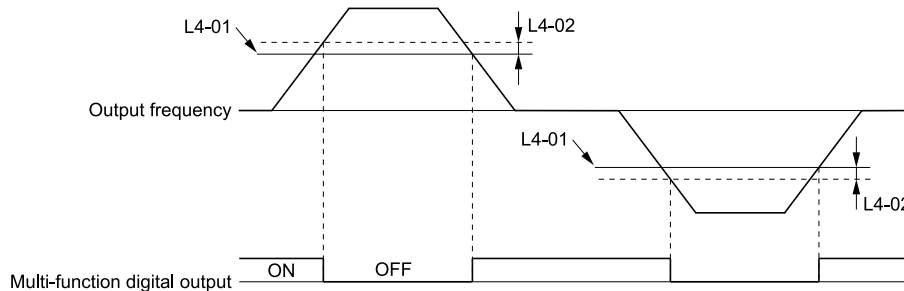


Figure 11.95 Frequency Detection 1 Time Chart

**Note:**

Figure 11.95 shows the result of the configuration when *L4-07* = 1 [Speed Agree Detection Selection = Detection Always Enabled]. The default setting of *L4-07* is 0 [No Detection during Baseblock]. When the speed agreement detection selection is “No Detection during Baseblock”, the terminal is deactivated when the drive output stops.

## ■ 5: Frequency Detection 2

Setting	Function	Description
5	Frequency Detection 2	<div style="display: flex; justify-content: space-between; align-items: center;"> <span>V/f</span> <span>CL-V/f</span> <span>OLV</span> <span>CLV</span> <span>AOLV</span> <span>OLV/PM</span> <span>AOLV/PM</span> <span>CLV/PM</span> <span>EZOLV</span> </div> <p>The terminal activates when the output frequency is higher than the setting value of L4-01 [Speed Agree Detection Level]. After the terminal activates, the terminal stays on until the output frequency is at the value of L4-01 - L4-02.</p>

### Note:

- The motor rotation direction does not have an effect on the detection function. The drive uses the L4-01 value as the forward/reverse detection level.
- CLV control uses motor speed as the reference.

**ON :** The output frequency is higher than the value of L4-01.

**OFF :** The output frequency is less than the value of “L4-01 - L4-02”, or is less than the value of L4-01.

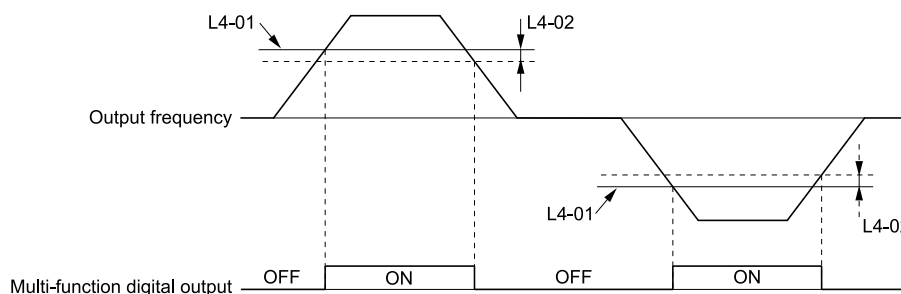


Figure 11.96 Frequency Detection 2 Time Chart

## ■ 6: Drive Ready

Setting	Function	Description
6	Drive Ready	<div style="display: flex; justify-content: space-between; align-items: center;"> <span>V/f</span> <span>CL-V/f</span> <span>OLV</span> <span>CLV</span> <span>AOLV</span> <span>OLV/PM</span> <span>AOLV/PM</span> <span>CLV/PM</span> <span>EZOLV</span> </div> <p>The terminal activates when the drive is ready and running.</p>

The terminal deactivates in these conditions:

- When the power supply is OFF
- During a fault
- When there is problem with the control power supply
- When there is a parameter configuration error and the drive cannot operate although there is a Run command
- When you enter a Run command and it immediately triggers an overvoltage or undervoltage fault
- When the drive is in Programming Mode and will not accept a Run command

## ■ 7: DC Bus Undervoltage

Setting	Function	Description
7	DC Bus Undervoltage	<div style="display: flex; justify-content: space-between; align-items: center;"> <span>V/f</span> <span>CL-V/f</span> <span>OLV</span> <span>CLV</span> <span>AOLV</span> <span>OLV/PM</span> <span>AOLV/PM</span> <span>CLV/PM</span> <span>EZOLV</span> </div> <p>The terminal activates when the DC bus voltage or control circuit power supply is less than the voltage set with L2-05 [Undervoltage Detect Level (Uv1)]. The terminal also turns on when there is a fault with the DC bus voltage.</p>

**ON :** The DC bus voltage is less than the setting value of L2-05.

**OFF :** The DC bus voltage is more than the setting value of L2-05.

## ■ 8: During Baseblock (N.O.)

Setting	Function	Description
8	During Baseblock (N.O.)	<div style="display: flex; justify-content: space-between; align-items: center;"> <span>V/f</span> <span>CL-V/f</span> <span>OLV</span> <span>CLV</span> <span>AOLV</span> <span>OLV/PM</span> <span>AOLV/PM</span> <span>CLV/PM</span> <span>EZOLV</span> </div> <p>The terminal turns on during baseblock. When the drive is in baseblock, the drive output transistor stops switching and the drive will not make DC bus voltage.</p>

**ON :** During baseblock

**OFF :** The drive is not in baseblock.

### ■ 9: Frequency Reference from Keypad

Setting	Function	Description
9	Frequency Reference from Keypad	<b>V/f</b> <b>CL-V/f</b> <b>OLV</b> <b>CLV</b> <b>AOLV</b> <b>OLV/PM</b> <b>AOLV/PM</b> <b>CLV/PM</b> <b>EZOLV</b> Shows the selected frequency reference source.

**ON** : The keypad is the frequency reference source.

**OFF** : **b1-01** or **b1-15** [*Frequency Reference Selection 1 or 2*] is the frequency reference source.

### ■ A: Run Command from Keypad

Setting	Function	Description
A	Run Command from Keypad	<b>V/f</b> <b>CL-V/f</b> <b>OLV</b> <b>CLV</b> <b>AOLV</b> <b>OLV/PM</b> <b>AOLV/PM</b> <b>CLV/PM</b> <b>EZOLV</b> Shows the selected Run command source.

**ON** : The keypad is the Run command source.

**OFF** : **b1-02** or **b1-16** [*Run Command Selection 1 or 2*] is the Run command source.

### ■ B: Torque Detection 1 (N.O.)

Setting	Function	Description
B	Torque Detection 1 (N.O.)	<b>V/f</b> <b>CL-V/f</b> <b>OLV</b> <b>CLV</b> <b>AOLV</b> <b>OLV/PM</b> <b>AOLV/PM</b> <b>CLV/PM</b> <b>EZOLV</b> The terminal activates when the drive detects overtorque or undertorque.

**ON** : The output current/torque is more than the torque value set with **L6-02** [*Torque Detection Level 1*], or the level is less than the torque value set with **L6-02** for longer than the time set with **L6-03** [*Torque Detection Time 1*].

Note:

- When **L6-01**  $\geq 5$ , the drive will detect when the output current/torque is less than the detection level of **L6-02** for longer than the time set in **L6-03**.
- Refer to "L6: Torque Detection" for more information.

### ■ C: Frequency Reference Loss

Setting	Function	Description
C	Frequency Reference Loss	<b>V/f</b> <b>CL-V/f</b> <b>OLV</b> <b>CLV</b> <b>AOLV</b> <b>OLV/PM</b> <b>AOLV/PM</b> <b>CLV/PM</b> <b>EZOLV</b> The terminal activates when the drive detects a loss of frequency reference.

Note:

Refer to "L4-05: Fref Loss Detection Selection" for more information.

### ■ D: Braking Resistor Fault

Setting	Function	Description
D	Braking Resistor Fault	<b>V/f</b> <b>CL-V/f</b> <b>OLV</b> <b>CLV</b> <b>AOLV</b> <b>OLV/PM</b> <b>AOLV/PM</b> <b>CLV/PM</b> <b>EZOLV</b> The terminal activates when the mounting-type braking resistor is overheating or when there is a braking transistor fault.

### ■ E: Fault

Setting	Function	Description
E	Fault	<b>V/f</b> <b>CL-V/f</b> <b>OLV</b> <b>CLV</b> <b>AOLV</b> <b>OLV/PM</b> <b>AOLV/PM</b> <b>CLV/PM</b> <b>EZOLV</b> The terminal activates when the drive detects a fault.

Note:

The terminal will not turn on for **CPF00** and **CPF01** [*Control Circuit Error*] faults.

### ■ F: Not Used

Setting	Function	Description
F	Not Used	<b>V/f</b> <b>CL-V/f</b> <b>OLV</b> <b>CLV</b> <b>AOLV</b> <b>OLV/PM</b> <b>AOLV/PM</b> <b>CLV/PM</b> <b>EZOLV</b> Use this setting for unused terminals or to use terminals in through mode. Also use this setting as the PLC contact output via MEMOBUS/Modbus or the communication option. This signal does not function if signals from the PLC are not configured.

### ■ 10: Alarm

Setting	Function	Description
10	Alarm	<b>V/f</b> <b>CL-V/f</b> <b>OLV</b> <b>CLV</b> <b>AOLV</b> <b>OLV/PM</b> <b>AOLV/PM</b> <b>CLV/PM</b> <b>EZOLV</b> The terminal turns on when the drive detects a minor fault.

### ■ 11: Fault Reset Command Active

Setting	Function	Description
11	Fault Reset Command Active	<b>V/f</b> <b>CL-V/f</b> <b>OLV</b> <b>CLV</b> <b>AOLV</b> <b>OLV/PM</b> <b>AOLV/PM</b> <b>CLV/PM</b> <b>EZOLV</b> The terminal turns on when the drive receives the Reset command from the control circuit terminal, serial communications, or the communication option.

### ■ 12: Timer Output

Setting	Function	Description
12	Timer Output	<b>V/f</b> <b>CL-V/f</b> <b>OLV</b> <b>CLV</b> <b>AOLV</b> <b>OLV/PM</b> <b>AOLV/PM</b> <b>CLV/PM</b> <b>EZOLV</b> Use this setting when the drive uses the timer function as an output terminal.

**Note:**

Refer to “b4: Timer Function” for more information.

### ■ 13: Speed Agree 2

Setting	Function	Description
13	Speed Agree 2	<b>V/f</b> <b>CL-V/f</b> <b>OLV</b> <b>CLV</b> <b>AOLV</b> <b>OLV/PM</b> <b>AOLV/PM</b> <b>CLV/PM</b> <b>EZOLV</b> The terminal activates when the output frequency is in the range of the frequency reference $\pm L4-04$ [Speed Agree Detection Width (+/-)].

**Note:**

- The motor rotation direction does not have an effect on the detection function. The drive uses the *L4-01* value as the forward/reverse detection level.
- CLV and CLV/PM control use motor speed as the reference.

**ON** : The output frequency is in the range of “frequency reference  $\pm L4-04$ ”.

**OFF** : The output frequency is not in the range of “frequency reference  $\pm L4-04$ ”.

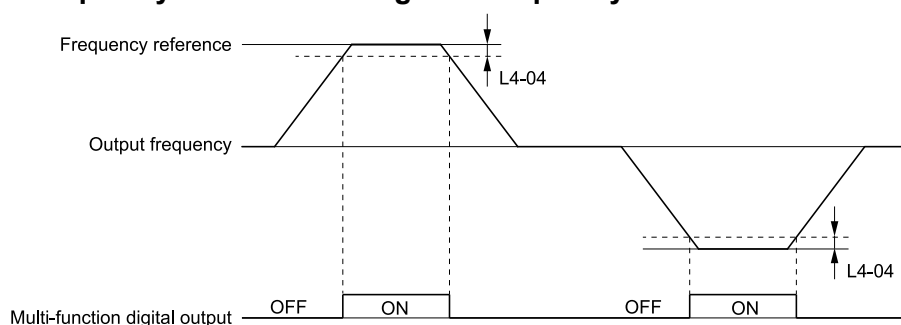


Figure 11.97 Speed Agree 2 Time Chart

### ■ 14: User-Set Speed Agree 2

Setting	Function	Description
14	User-Set Speed Agree 2	<b>V/f</b> <b>CL-V/f</b> <b>OLV</b> <b>CLV</b> <b>AOLV</b> <b>OLV/PM</b> <b>AOLV/PM</b> <b>CLV/PM</b> <b>EZOLV</b> The terminal activates when the output frequency is in the range of <i>L4-03</i> [Speed Agree Detect Level (+/-)] $\pm L4-04$ [Speed Agree Detect Width (+/-)] and in the range of the frequency reference $\pm L4-04$ .

**Note:**

- The detection level configured with *L4-03* is a signed value. The drive will only detect in one direction.
- CLV and CLV/PM control use motor speed as the reference.

**ON** : The output frequency is in the range of “*L4-03*  $\pm L4-04$ ” and the range of frequency reference  $\pm L4-04$ .

**OFF** : The output frequency is not in the range of “*L4-03*  $\pm L4-04$ ” or the in the range of frequency reference  $\pm L4-04$ .

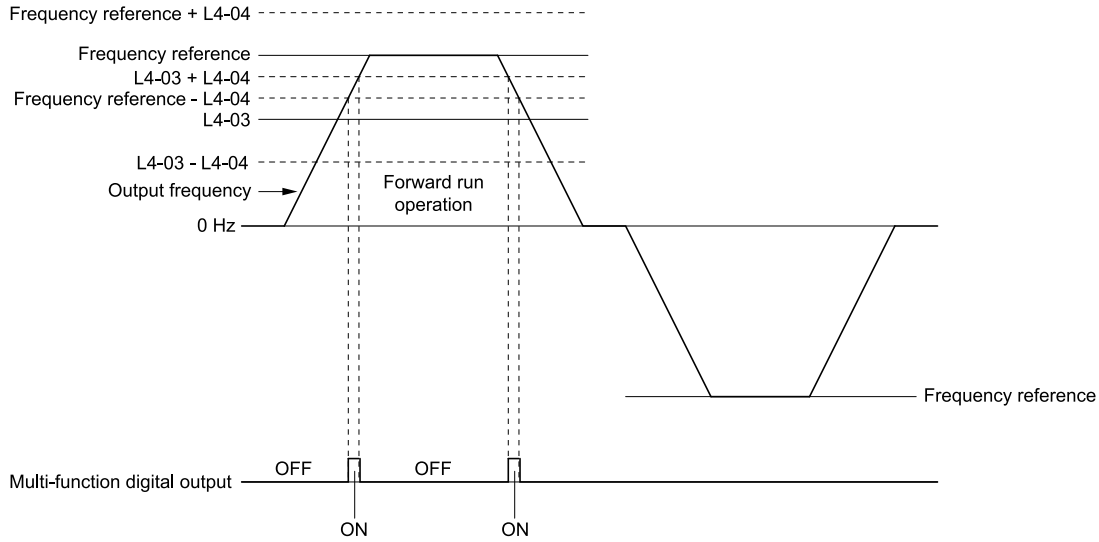


Figure 11.98 Example of User-set Speed Agree 2 (L4-03 Is Positive)

■ 15: Frequency Detection 3

Setting	Function	Description
15	Frequency Detection 3	<p><b>V/f</b> <b>CL-V/f</b> <b>OLV</b> <b>CLV</b> <b>AOLV</b> <b>OLV/PM</b> <b>AOLV/PM</b> <b>CLV/PM</b> <b>EZOLV</b></p> <p>The terminal deactivates when the output frequency is higher than the setting value of “L4-03 [Speed Agree Detect Level (+/-)] + L4-04 [Speed Agree Detect Width (+/-)]”. After the terminal deactivates, the terminal stays off until the output frequency is at the value of L4-03.</p>

**Note:**

- The detection level set with L4-03 is a signed value. The drive will only detect in one direction.
- CLV and CLV/PM control use motor speed as the reference.

**ON :** The output frequency is less than the value of L4-03 or is not higher than the value of L4-03 + L4-04.

**OFF :** The output frequency is higher than the value of L4-03 + L4-04.

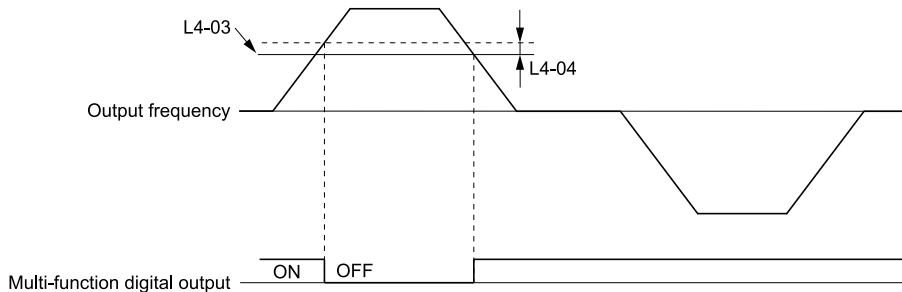


Figure 11.99 Example of Frequency Detection 3 (value of L4-03 Is Positive)

**Note:**

Figure 11.99 shows the result of the configuration when L4-07 = 1 [Speed Agree Detection Selection = Detection Always Enabled]. The default setting of L4-07 is 0 [No Detection during Baseblock]. When the speed agreement detection selection is “No Detection during Baseblock”, the terminal is deactivated when the drive output stops.

■ 16: Frequency Detection 4

Setting	Function	Description
16	Frequency Detection 4	<p><b>V/f</b> <b>CL-V/f</b> <b>OLV</b> <b>CLV</b> <b>AOLV</b> <b>OLV/PM</b> <b>AOLV/PM</b> <b>CLV/PM</b> <b>EZOLV</b></p> <p>The terminal activates when the output frequency is higher than the value of L4-03 [Speed Agree Detect Level (+/-)]. After the terminal activates, the terminal stays on until the output frequency is at the value of L4-03 - L4-04.</p>

**Note:**

- The detection level set with L4-03 is a signed value. The drive will only detect in one direction.
- CLV control uses motor speed as the reference.

**ON :** The output frequency is higher than the value of L4-03.

**OFF** : The output frequency is less than the value of “L4-03 - L4-04”, or it is not higher than the value of L4-03.

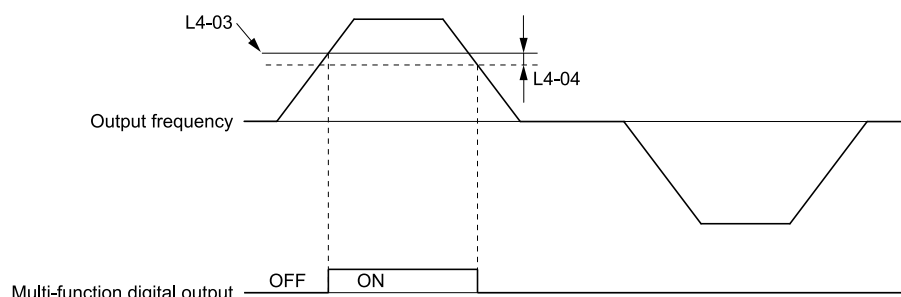


Figure 11.100 Example of Frequency Detection 4 (value of L4-03 is Positive)

### ■ 17: Torque Detection 1 (N.C.)

Setting	Function	Description
17	Torque Detection 1 (N.C.)	<b>V/f</b> <b>CL-V/f</b> <b>OLV</b> <b>CLV</b> <b>AOLV</b> <b>OLV/PM</b> <b>AOLV/PM</b> <b>CLV/PM</b> <b>EZOLV</b> The terminal deactivates when the drive detects overtorque or undertorque.

Use the L6 [Torque Detection] parameters to set torque detection.

**OFF** : The output current/torque is more than the torque value set with L6-02 [Torque Detection Level 1], or the level is less than the torque value set with L6-02 for longer than the time set with L6-03 [Torque Detection Time 1].

**Note:**

- When  $L6-01 \geq 5$ , the drive will detect when the output current/torque is less than the detection level of L6-02 for longer than the time set in L6-03.
- Refer to “L6: Torque Detection” for more information.

### ■ 18: Torque Detection 2 (N.O.)

Setting	Function	Description
18	Torque Detection 2 (N.O.)	<b>V/f</b> <b>CL-V/f</b> <b>OLV</b> <b>CLV</b> <b>AOLV</b> <b>OLV/PM</b> <b>AOLV/PM</b> <b>CLV/PM</b> <b>EZOLV</b> The terminal activates when the drive detects overtorque or undertorque.

Use the L6 [Torque Detection] parameters to set torque detection.

**ON** : The output current/torque is more than the torque value set with L6-05 [Torque Detection Level 2], or the level is less than the torque value set with L6-05 for longer than the time set with L6-06 [Torque Detection Time 2].

**Note:**

- When  $L6-04 \geq 5$ , the drive will detect when the output current/torque is less than the detection level of L6-05 for longer than the time set in L6-06.
- Refer to “L6: Torque Detection” for more information.

### ■ 19: Torque Detection 2 (N.C.)

Setting	Function	Description
19	Torque Detection 2 (N.C.)	<b>V/f</b> <b>CL-V/f</b> <b>OLV</b> <b>CLV</b> <b>AOLV</b> <b>OLV/PM</b> <b>AOLV/PM</b> <b>CLV/PM</b> <b>EZOLV</b> The terminal deactivates when the drive detects overtorque or undertorque.

Use the L6 [Torque Detection] parameters to set torque detection.

**OFF** : The output current/torque is more than the torque value set with L6-05 [Torque Detection Level 2], or the level is less than the torque value set with L6-05 for longer than the time set with L6-06 [Torque Detection Time 2].

**Note:**

- When  $L6-04 \geq 5$ , the drive will detect when the output current/torque is less than the detection level of L6-05 for longer than the time set in L6-06.
- Refer to “L6: Torque Detection” for more information.

■ 1A: During Reverse

Setting	Function	Description
1A	During Reverse	<div style="display: flex; justify-content: space-between; font-size: small;"> <span>V/f</span> <span>CL-V/f</span> <span>OLV</span> <span>CLV</span> <span>AOLV</span> <span>OLV/PM</span> <span>AOLV/PM</span> <span>CLV/PM</span> <span>EZOLV</span> </div> <p>The terminal activates when the motor operates in the reverse direction.</p>

**ON :** The motor is operating in the reverse direction.

**OFF :** The motor is operating in the forward direction or the motor stopped.

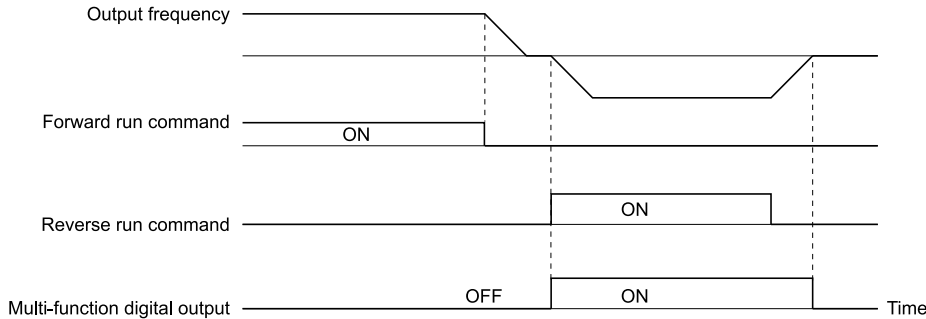


Figure 11.101 Reverse Operation Output Time Chart

■ 1B: During Baseblock (N.C.)

Setting	Function	Description
1B	During Baseblock (N.C.)	<div style="display: flex; justify-content: space-between; font-size: small;"> <span>V/f</span> <span>CL-V/f</span> <span>OLV</span> <span>CLV</span> <span>AOLV</span> <span>OLV/PM</span> <span>AOLV/PM</span> <span>CLV/PM</span> <span>EZOLV</span> </div> <p>The terminal deactivates during baseblock. When the drive is in baseblock, the drive output transistor stops switching and does not make DC bus voltage.</p>

**ON :** The drive is not in baseblock.

**OFF :** During baseblock

■ 1C: Motor 2 Selected

Setting	Function	Description
1C	Motor 2 Selected	<div style="display: flex; justify-content: space-between; font-size: small;"> <span>V/f</span> <span>CL-V/f</span> <span>OLV</span> <span>CLV</span> <span>AOLV</span> <span>OLV/PM</span> <span>AOLV/PM</span> <span>CLV/PM</span> <span>EZOLV</span> </div> <p>The terminal activates when motor 2 is selected.</p>

**ON :** Motor 2 Selection

**OFF :** Motor 1 Selection

■ 1D: During Regeneration

Setting	Function	Description
1D	During Regeneration	<div style="display: flex; justify-content: space-between; font-size: small;"> <span>V/f</span> <span>CL-V/f</span> <span>OLV</span> <span>CLV</span> <span>AOLV</span> <span>OLV/PM</span> <span>AOLV/PM</span> <span>CLV/PM</span> <span>EZOLV</span> </div> <p>The terminal activates on when the motor is regenerating.</p>

**ON :** Motor is regenerating.

**OFF :** Motor is operating or stopped.

■ 1E: Executing Auto-Restart

Setting	Function	Description
1E	Executing Auto-Restart	<div style="display: flex; justify-content: space-between; font-size: small;"> <span>V/f</span> <span>CL-V/f</span> <span>OLV</span> <span>CLV</span> <span>AOLV</span> <span>OLV/PM</span> <span>AOLV/PM</span> <span>CLV/PM</span> <span>EZOLV</span> </div> <p>The terminal activates when the Auto Restart function is trying to restart after a fault.</p>

The terminal deactivates when the Auto Restart function automatically resets a fault. The terminal deactivates when the Auto Restart function detects the fault again because the Auto Restart function cannot operate when the drive reaches the number of attempts set with L5-01 [Number of Auto Restart Attempts].

**Note:**

Refer to "L5: Fault Restart" for more information.



### ■ 1F: Motor Overload Alarm (oL1)

Setting	Function	Description
1F	Motor Overload Alarm (oL1)	<div style="display: flex; justify-content: space-between; gap: 5px;"> <span>V/f</span> <span>CL-V/f</span> <span>OLV</span> <span>CLV</span> <span>AOLV</span> <span>OLV/PM</span> <span>AOLV/PM</span> <span>CLV/PM</span> <span>EZOLV</span> </div> <p>The terminal activates when the electronic thermal protection value of the motor overload protective function is a minimum of 90% of the detection level.</p>

**Note:**

Refer to “L1-01: Motor Overload (oL1) Protection” for more information.

### ■ 20: Drive Overheat Pre-Alarm (oH)

Setting	Function	Description
20	Drive Overheat Pre-Alarm (oH)	<div style="display: flex; justify-content: space-between; gap: 5px;"> <span>V/f</span> <span>CL-V/f</span> <span>OLV</span> <span>CLV</span> <span>AOLV</span> <span>OLV/PM</span> <span>AOLV/PM</span> <span>CLV/PM</span> <span>EZOLV</span> </div> <p>The terminal activates when the drive heatsink temperature is at the level set with L8-02 [Overheat Alarm Level].</p>

**Note:**

Refer to “L8-02: Overheat Alarm Level” for more information.

### ■ 21: Safe Torque OFF

Setting	Function	Description
21	Safe Torque OFF	<div style="display: flex; justify-content: space-between; gap: 5px;"> <span>V/f</span> <span>CL-V/f</span> <span>OLV</span> <span>CLV</span> <span>AOLV</span> <span>OLV/PM</span> <span>AOLV/PM</span> <span>CLV/PM</span> <span>EZOLV</span> </div> <p>The terminal turns on (safety stop state) when the safety circuit and safety diagnosis circuit are operating correctly and when terminals H1-HC and H2-HC are off (released).</p>

**Note:**

EDM = External Device Monitor

### ON : Safety stop state

Terminals H1-HC and H2-HC are OFF or released (safety stop state).

### OFF : Safety circuit fault or RUN/READY

Terminal H1-HC or terminal H2-HC is OFF or released (safety circuit fault), or the two terminals are ON or have short circuited (RUN/READY).

### ■ 22: Mechanical Weakening Detection

Setting	Function	Description
22	Mechanical Weakening Detection	<div style="display: flex; justify-content: space-between; gap: 5px;"> <span>V/f</span> <span>CL-V/f</span> <span>OLV</span> <span>CLV</span> <span>AOLV</span> <span>OLV/PM</span> <span>AOLV/PM</span> <span>CLV/PM</span> <span>EZOLV</span> </div> <p>The terminal activates when the drive detects mechanical weakening.</p>

**Note:**

Refer to “Mechanical Weakening Detection Function” for more information.

### ■ 2F: Maintenance Notification

Setting	Function	Description
2F	Maintenance Notification	<div style="display: flex; justify-content: space-between; gap: 5px;"> <span>V/f</span> <span>CL-V/f</span> <span>OLV</span> <span>CLV</span> <span>AOLV</span> <span>OLV/PM</span> <span>AOLV/PM</span> <span>CLV/PM</span> <span>EZOLV</span> </div> <p>The terminal activates when drive components are at their estimated maintenance period.</p>

Tells the user about the maintenance period for these items:

- IGBT
- Cooling fan
- Capacitor
- Soft charge bypass relay

**Note:**

Refer to “Alarm Outputs for Maintenance Monitors” for more information.

■ **30: During Torque Limit**

Setting	Function	Description
30	During Torque Limit	<div style="display: flex; justify-content: space-between; align-items: center;"> <span>V/f</span> <span>CL-V/f</span> <span>OLV</span> <span>CLV</span> <span>AOLV</span> <span>OLV/PM</span> <span>AOLV/PM</span> <span>CLV/PM</span> <span>EZOLV</span> </div> <p>The terminal activates when the torque reference is the torque limit set with <i>L7 parameters, H3-02, H3-06, or H3-10 [MFAI Function Select]</i>.</p>

**Note:**

Refer to “L7: Torque Limit” for more information.

■ **31: During Speed Limit**

Setting	Function	Description
31	During Speed Limit	<div style="display: flex; justify-content: space-between; align-items: center;"> <span>V/f</span> <span>CL-V/f</span> <span>OLV</span> <span>CLV</span> <span>AOLV</span> <span>OLV/PM</span> <span>AOLV/PM</span> <span>CLV/PM</span> <span>EZOLV</span> </div> <p>The terminal activates when the speed limit is active.</p>

The frequency limit activates and the terminal activates in these conditions:

- The frequency reference  $\geq d2-01$  [*Frequency Reference Upper Limit*]
- The frequency reference  $\leq d2-02$  [*Frequency Reference Lower Limit*] or  $d2-03$  [*Analog Frequency Ref Lower Limit*].
- The frequency reference  $\leq E1-09$  [*Minimum Output Frequency*] when  $b1-05 = 1, 2, \text{ or } 3$  [*Operation Below Minimum Freq = Baseblock (Motor Coasts), Operate at Minimum Frequency, or Operate at Zero Speed*].
- The frequency reference  $\leq$  *Output Freq Lower Limit Level [H3-xx = 9]* through analog input.

■ **32: In Speed Limit During Trq Ctrl**

Setting	Function	Description
32	In Speed Limit During Trq Ctrl	<div style="display: flex; justify-content: space-between; align-items: center;"> <span>V/f</span> <span>CL-V/f</span> <span>OLV</span> <span>CLV</span> <span>AOLV</span> <span>OLV/PM</span> <span>AOLV/PM</span> <span>CLV/PM</span> <span>EZOLV</span> </div> <p>The motor accelerates in the forward direction or the reverse direction after enabling torque control and the externally input torque reference is disproportionate to the load. The output terminal activates when this speed is not higher than a constant speed and the motor speed is at the speed limit. This does not include operation when the drive is stopped.</p>

**Note:**

Refer to “d5-03: Speed Limit Selection” for more information.

■ **33: Zero Servo Complete**

Setting	Function	Description
33	Zero Servo Complete	<div style="display: flex; justify-content: space-between; align-items: center;"> <span>V/f</span> <span>CL-V/f</span> <span>OLV</span> <span>CLV</span> <span>AOLV</span> <span>OLV/PM</span> <span>AOLV/PM</span> <span>CLV/PM</span> <span>EZOLV</span> </div> <p>The terminal activates when positioning in the range set with <math>b9-02</math> [<i>Zero Servo Completion Window</i>] completes after sending the Zero-Servo command.</p>

**Note:**

Refer to “b9: Zero Servo” for more information.

■ **37: During Frequency Output**

Setting	Function	Description
37	During Frequency Output	<div style="display: flex; justify-content: space-between; align-items: center;"> <span>V/f</span> <span>CL-V/f</span> <span>OLV</span> <span>CLV</span> <span>AOLV</span> <span>OLV/PM</span> <span>AOLV/PM</span> <span>CLV/PM</span> <span>EZOLV</span> </div> <p>The terminal activates when the drive outputs frequency.</p>

**ON** : The drive outputs frequency.

**OFF** : The drive does not output frequency.

**Note:**

The terminal deactivates in these conditions:

- During Stop
- During baseblock
- During DC Injection Braking (initial excitation)
- During Short Circuit Braking

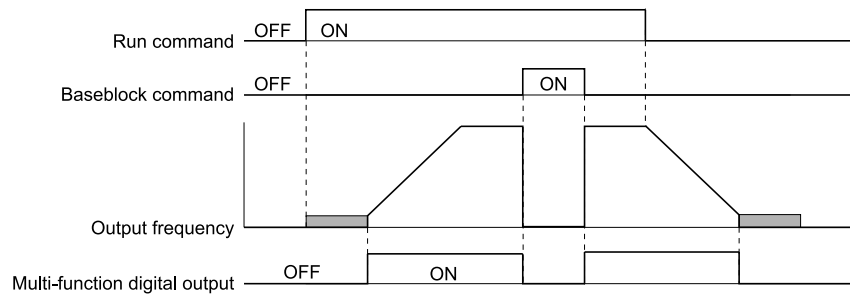


Figure 11.102 Active Frequency Output Time Chart

### ■ 38: Drive Enabled

Setting	Function	Description
38	Drive Enabled	<b>V/f</b> <b>CL-V/f</b> <b>OLV</b> <b>CLV</b> <b>AOLV</b> <b>OLV/PM</b> <b>AOLV/PM</b> <b>CLV/PM</b> <b>EZOLV</b> This terminal activates when the $H1-xx = 6A$ [Drive Enable] terminal activates.

### ■ 39: Watt Hour Pulse Output

Setting	Function	Description
39	Watt Hour Pulse Output	<b>V/f</b> <b>CL-V/f</b> <b>OLV</b> <b>CLV</b> <b>AOLV</b> <b>OLV/PM</b> <b>AOLV/PM</b> <b>CLV/PM</b> <b>EZOLV</b> Outputs the pulse that shows the watt hours.

**Note:**

Refer to “H2-06: Watt Hour Output Unit Selection” for more information.

### ■ 3C: LOCAL Control Selected

Setting	Function	Description
3C	LOCAL Control Selected	<b>V/f</b> <b>CL-V/f</b> <b>OLV</b> <b>CLV</b> <b>AOLV</b> <b>OLV/PM</b> <b>AOLV/PM</b> <b>CLV/PM</b> <b>EZOLV</b> The terminal activates when the Run command source or frequency reference source is LOCAL.

#### ON : LOCAL

The keypad is the Run command source or the frequency reference source.

#### OFF : REMOTE

The Run command source or frequency reference source is an external source set with  $b1-01$  [Frequency Reference Selection 1],  $b1-15$  [Frequency Reference Selection 2],  $b1-02$  [Run Command Selection 1], or  $b1-16$  [Run Command Selection 2].

### ■ 3D: During Speed Search

Setting	Function	Description
3D	During Speed Search	<b>V/f</b> <b>CL-V/f</b> <b>OLV</b> <b>CLV</b> <b>AOLV</b> <b>OLV/PM</b> <b>AOLV/PM</b> <b>CLV/PM</b> <b>EZOLV</b> The terminal activates when the drive is doing speed search.

**Note:**

Refer to “b3: Speed Search” for more information.

### ■ 3E: PID Feedback Low

Setting	Function	Description
3E	PID Feedback Low	<b>V/f</b> <b>CL-V/f</b> <b>OLV</b> <b>CLV</b> <b>AOLV</b> <b>OLV/PM</b> <b>AOLV/PM</b> <b>CLV/PM</b> <b>EZOLV</b> The activates when the drive detects $FbL$ [PID Feedback Loss].

The drive detects  $FbL$  [PID Feedback Loss] when the PID feedback value  $< b5-13$  [PID Feedback Loss Detection Lvl] for longer than the time set in  $b5-14$  [PID Feedback Loss Detection Time].

**Note:**

Refer to “PID Feedback Loss Detection” for more information.

### ■ 3F: PID Feedback High

Setting	Function	Description
3F	PID Feedback High	<div style="display: flex; justify-content: space-between; gap: 5px;"> <span>V/f</span> <span>CL-V/f</span> <span>OLV</span> <span>CLV</span> <span>AOLV</span> <span>OLV/PM</span> <span>AOLV/PM</span> <span>CLV/PM</span> <span>EZOLV</span> </div> <p>The terminal activates when the drive detects <i>FbH</i> [Excessive PID Feedback].</p>

The drive detects *FbH* [Excessive PID Feedback] when the PID feedback value > *b5-36* [PID High Feedback Detection Lvl] for longer than the time set in *b5-37* [PID High Feedback Detection Time].

**Note:**

Refer to “PID Feedback Loss Detection” for more information.

### ■ 4A: During KEB Ride-Thru

Setting	Function	Description
4A	During KEB Ride-Thru	<div style="display: flex; justify-content: space-between; gap: 5px;"> <span>V/f</span> <span>CL-V/f</span> <span>OLV</span> <span>CLV</span> <span>AOLV</span> <span>OLV/PM</span> <span>AOLV/PM</span> <span>CLV/PM</span> <span>EZOLV</span> </div> <p>The activates during KEB Ride-Thru.</p>

**Note:**

Refer to “KEB Ride-Thru function” for more information.

### ■ 4B: During Short Circuit Braking

Setting	Function	Description
4B	During Short Circuit Braking	<div style="display: flex; justify-content: space-between; gap: 5px;"> <span>V/f</span> <span>CL-V/f</span> <span>OLV</span> <span>CLV</span> <span>AOLV</span> <span>OLV/PM</span> <span>AOLV/PM</span> <span>CLV/PM</span> <span>EZOLV</span> </div> <p>The terminal activates during Short Circuit Braking.</p>

**Note:**

- When *A1-02* = 8 [Control Method Selection = EZ Vector Control], this function is available if you use a PM motor.

- Refer to “b2: DC Circuit Braking” for more information.

### ■ 4C: During Fast Stop

Setting	Function	Description
4C	During Fast Stop	<div style="display: flex; justify-content: space-between; gap: 5px;"> <span>V/f</span> <span>CL-V/f</span> <span>OLV</span> <span>CLV</span> <span>AOLV</span> <span>OLV/PM</span> <span>AOLV/PM</span> <span>CLV/PM</span> <span>EZOLV</span> </div> <p>The terminal activates when the fast stop is in operation.</p>

### ■ 4D: oH Pre-Alarm Reduction Limit

Setting	Function	Description
4D	oH Pre-Alarm Reduction Limit	<div style="display: flex; justify-content: space-between; gap: 5px;"> <span>V/f</span> <span>CL-V/f</span> <span>OLV</span> <span>CLV</span> <span>AOLV</span> <span>OLV/PM</span> <span>AOLV/PM</span> <span>CLV/PM</span> <span>EZOLV</span> </div> <p>The terminal activates when <i>L8-03</i> = 4 [Overheat Pre-Alarm Selection = Operate at Reduced Speed (L8-19)] and <i>oH</i> [Heatsink Overheat] does not clear after the drive decreases the frequency for 10 cycles.</p>

**Note:**

Refer to “L8-03: Overheat Pre-Alarm Selection” for more information.

### ■ 4E: Braking Transistor Fault (rr)

Setting	Function	Description
4E	Braking Transistor Fault (rr)	<div style="display: flex; justify-content: space-between; gap: 5px;"> <span>V/f</span> <span>CL-V/f</span> <span>OLV</span> <span>CLV</span> <span>AOLV</span> <span>OLV/PM</span> <span>AOLV/PM</span> <span>CLV/PM</span> <span>EZOLV</span> </div> <p>The terminal activates when the internal braking transistor overheats and the drive detects an <i>rr</i> [Dynamic Braking Transistor Fault] fault.</p>

### ■ 4F: Braking Resistor Overheat (rH)

Setting	Function	Description
4F	Braking Resistor Overheat (rH)	<div style="display: flex; justify-content: space-between; gap: 5px;"> <span>V/f</span> <span>CL-V/f</span> <span>OLV</span> <span>CLV</span> <span>AOLV</span> <span>OLV/PM</span> <span>AOLV/PM</span> <span>CLV/PM</span> <span>EZOLV</span> </div> <p>The terminal activates when the braking resistor overheats and the drive detects an <i>rH</i> [Braking Resistor Overheat] fault.</p>

The braking resistor overheats when the deceleration time is short and there is too much motor regeneration energy.

### 60: Internal Cooling Fan Failure

Setting	Function	Description
60	Internal Cooling Fan Failure	<b>V/f</b> <b>CL-V/f</b> <b>OLV</b> <b>CLV</b> <b>AOLV</b> <b>OLV/PM</b> <b>AOLV/PM</b> <b>CLV/PM</b> <b>EZOLV</b> The terminal activates when the drive detects a cooling fan failure in the drive.

### 61: Pole Position Detection Complete

Setting	Function	Description
61	Pole Position Detection Complete	<b>V/f</b> <b>CL-V/f</b> <b>OLV</b> <b>CLV</b> <b>AOLV</b> <b>OLV/PM</b> <b>AOLV/PM</b> <b>CLV/PM</b> <b>EZOLV</b> The terminal activates when drive receives a Run command and the drive detects the motor magnetic pole position of the PM motor.

### 62: Modbus Reg 1 Status Satisfied

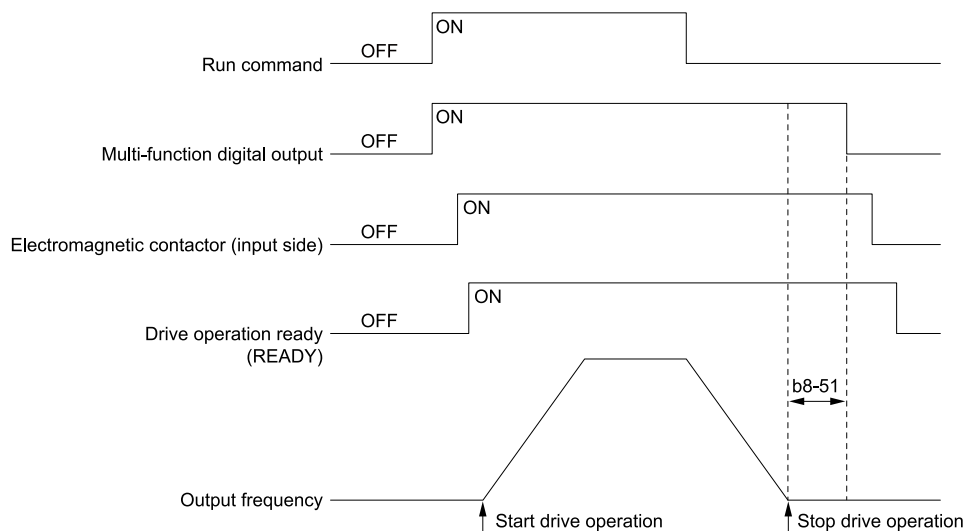
Setting	Function	Description
62	Modbus Reg 1 Status Satisfied	<b>V/f</b> <b>CL-V/f</b> <b>OLV</b> <b>CLV</b> <b>AOLV</b> <b>OLV/PM</b> <b>AOLV/PM</b> <b>CLV/PM</b> <b>EZOLV</b> The terminal activates when the bit specified by <i>H2-08 [Modbus Register 1 Bit Select]</i> for the MEMOBUS register address set with <i>H2-07 [Modbus Register 1 Address Select]</i> activates.

### 63: Modbus Reg 2 Status Satisfied

Setting	Function	Description
63	Modbus Reg 2 Status Satisfied	<b>V/f</b> <b>CL-V/f</b> <b>OLV</b> <b>CLV</b> <b>AOLV</b> <b>OLV/PM</b> <b>AOLV/PM</b> <b>CLV/PM</b> <b>EZOLV</b> The terminal activates when the bit specified by <i>H2-10 [Modbus Register 2 Bit Select]</i> for the MEMOBUS register address set with <i>H2-09 [Modbus Register 2 Address Select]</i> activates.

### 65: Standby Output

Setting	Function	Description
65	Standby Output	<b>V/f</b> <b>CL-V/f</b> <b>OLV</b> <b>CLV</b> <b>AOLV</b> <b>OLV/PM</b> <b>AOLV/PM</b> <b>CLV/PM</b> <b>EZOLV</b> The terminal deactivates after the drive stops operating and after the time set with <i>b8-51 [Standby Mode Wait Time]</i> .



**ON** : The Run command turns on and the magnetic contactor on the input side turns on.

**OFF** : The Run command turns off and the drive stops operating. Then, the magnetic contactor on the input side turns off after the time set with *b8-51 [Standby Mode Wait Time]* elapses.

### 66: Comparator1

Setting	Function	Description
66	Comparator1	<b>V/f</b> <b>CL-V/f</b> <b>OLV</b> <b>CLV</b> <b>AOLV</b> <b>OLV/PM</b> <b>AOLV/PM</b> <b>CLV/PM</b> <b>EZOLV</b> The monitor value set with <i>H2-20 [Comparator 1 Monitor Selection]</i> is on while in range of the time set with <i>H2-24 [Comparator 1 On-Delay Time]</i> and the values of <i>H2-21 [Comparator 1 Lower Limit]</i> and <i>H2-22 [Comparator 1 Upper Limit]</i> are in range.

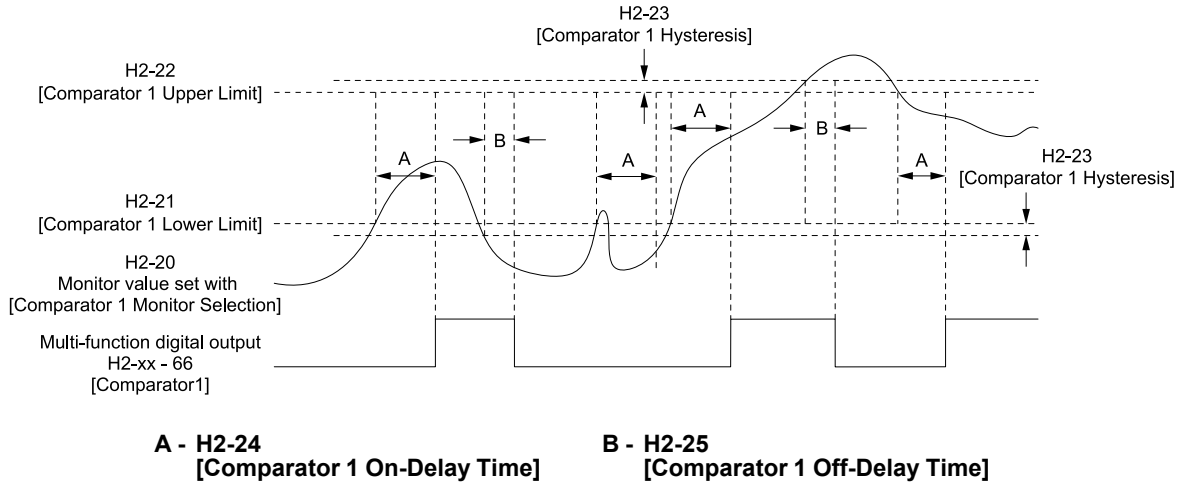


Figure 11.103 Comparator 1 Output Time Chart

**Note:**

The drive compares the monitors set with H2-20 as absolute values.

■ **67: Comparator2**

Setting	Function	Description
67	Comparator2	<div style="display: flex; justify-content: space-between; font-size: small;"> <span>V/f</span> <span>CL-V/f</span> <span>OLV</span> <span>CLV</span> <span>AOLV</span> <span>OLV/PM</span> <span>AOLV/PM</span> <span>CLV/PM</span> <span>EZOLV</span> </div> <p>The monitor value set with H2-26 [Comparator 2 Monitor Selection] is on while in range of the time set with H2-30 [Comparator 2 On-Delay Time] and the values of H2-27 [Comparator 2 Lower Limit] and H2-28 [Comparator 2 Upper Limit] are in range.</p>

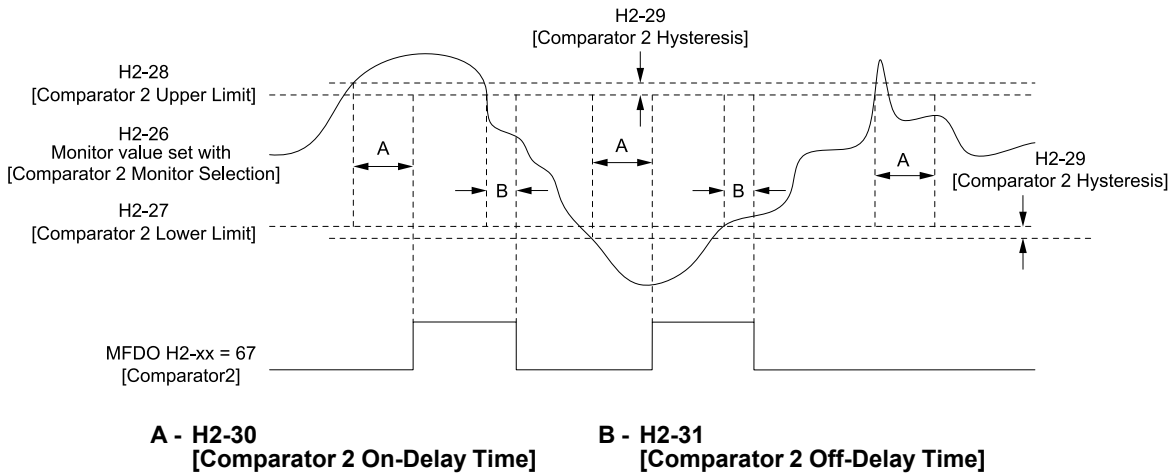


Figure 11.104 Comparator 2 Output Time Chart

**Note:**

The drive compares the monitors set with H2-26 as absolute values.

■ **69: External Power 24V Supply**

Setting	Function	Description
69	External Power 24V Supply	<div style="display: flex; justify-content: space-between; font-size: small;"> <span>V/f</span> <span>CL-V/f</span> <span>OLV</span> <span>CLV</span> <span>AOLV</span> <span>OLV/PM</span> <span>AOLV/PM</span> <span>CLV/PM</span> <span>EZOLV</span> </div> <p>The terminal activates when there is an external 24V power supply between terminals PS-AC.</p>

**ON** : An external 24V power supply supplies power.

**OFF** : An external 24V power supply does not supply power.

■ **6A: Data Logger Error**

Setting	Function	Description
6A	Data Logger Error	<div style="display: flex; justify-content: space-between; font-size: small;"> <span>V/f</span> <span>CL-V/f</span> <span>OLV</span> <span>CLV</span> <span>AOLV</span> <span>OLV/PM</span> <span>AOLV/PM</span> <span>CLV/PM</span> <span>EZOLV</span> </div> <p>The terminal activates when the drive detects a LoG [Com Error / Abnormal SD card].</p>

### ■ 90 to 93: DWEZ Digital Outputs 1 to 4

Setting	Function	Description
90 to 93	DWEZ Digital Outputs 1 to 4	<b>V/f</b> <b>CL-V/f</b> <b>OLV</b> <b>CLV</b> <b>AOLV</b> <b>OLV/PM</b> <b>AOLV/PM</b> <b>CLV/PM</b> <b>EZOLV</b> Sets the DriveWorksEZ digital output. Refer to the DriveWorksEZ online manual for more information.

### ■ A0 to A7: DWEZ Extended Digital Output 1 to 8

Setting Value	Function	Description
A0 to A7	DWEZ Extended Digital Output 1 to 8	<b>V/f</b> <b>CL-V/f</b> <b>OLV</b> <b>CLV</b> <b>AOLV</b> <b>OLV/PM</b> <b>AOLV/PM</b> <b>CLV/PM</b> <b>EZOLV</b> Sets the digital output for the DriveWorksEZ DO-A3 option card. Refer to the DriveWorksEZ online manual for more information.

### ■ 100 to 1A7: Inverse Output of 0 to A7

Setting	Function	Description
100 to 1A7	Inverse Output of 0 to A7	<b>V/f</b> <b>CL-V/f</b> <b>OLV</b> <b>CLV</b> <b>AOLV</b> <b>OLV/PM</b> <b>AOLV/PM</b> <b>CLV/PM</b> <b>EZOLV</b> Causes inverse output of the function for the selected MFDO. Uses the last two digits of 1xx to select which function to inversely output.

For example, set  $H2-xx = 10E$  for the inverse output of  $E$  [Fault].

## ◆ H3: Analog Inputs

**WARNING! Sudden Movement Hazard.** Do test runs and examine the drive to make sure that command references are configured correctly. If you set the command reference incorrectly, it can cause death, serious injury, or equipment damage from unwanted motor rotation.

Drives have three analog input terminals, terminals A1, A2, and A3. H3 parameters select the functions set to these analog input terminals and adjust signal levels.

Table 11.68 shows the functions that you can set to analog input terminals. Use H3-02, H3-06, and H3-10 [MFAI Function Select] to set functions.

Table 11.68 MFAI Setting Values

Setting	Function	Setting	Function
0	Frequency Reference	E	Motor Temperature (PTC Input)
1	Frequency Gain	F	Not Used
2	Auxiliary Frequency Reference 1	10	Forward Torque Limit
3	Auxiliary Frequency Reference 2	11	Reverse Torque Limit
4	Output Voltage Bias	12	Regenerative Torque Limit
5	Accel/Decel Time Gain	13	Torque Reference / Torque Limit
6	DC Injection Braking Current	14	Torque Compensation
7	Torque Detection Level	15	General Torque Limit
8	Stall Prevent Level During Run	16	Differential PID Feedback
9	Output Frequency Lower Limit	1F	Not Used
B	PID Feedback	30	DWEZ Analog Input 1
C	PID Setpoint	31	DWEZ Analog Input 2
D	Frequency Bias	32	DWEZ Analog Input 3

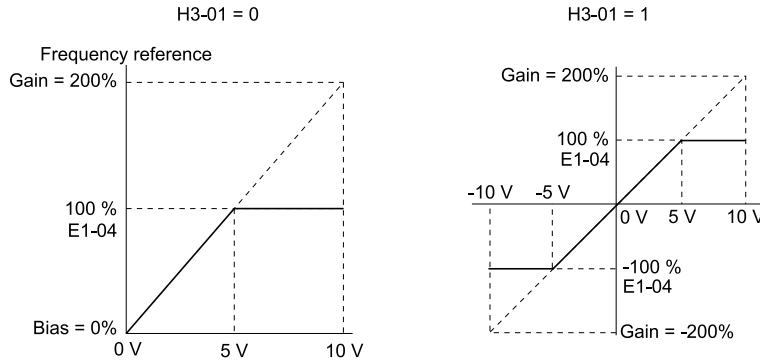
**Note:**

All analog input scaling uses gain and bias for adjustment. Set the gain and bias values correctly.

### ■ Example Analog Input Settings

- The function set for terminal A1 is set with Frequency Reference [ $H3-02 = 0$ ], the gain is 200% [ $H3-03 = 200.0$ ], and the bias is 0% [ $H3-04 = 0.0$ ].  
When you input a 10 V signal, the frequency reference will be 200%.

When you input a 5 V signal, the frequency reference will be 100%. Parameter *E1-04 [Maximum Output Frequency]* restricts drive output. When you input a 5 V or more signal, the frequency reference will be 100%.



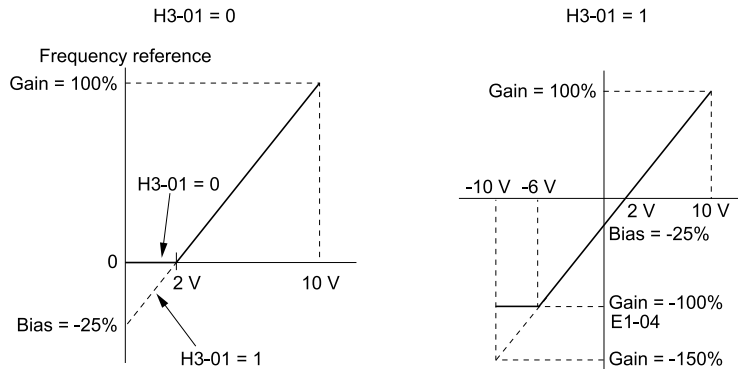
**Figure 11.105 Freq Reference When the Analog Input Gain Setting Is Adjusted**

- The function set for terminal A1 is set with *Frequency Reference [H3-02 = 0]*, the gain is 100% [*H3-03 = 100.0*], and the bias is -25% [*H3-04 = -25.0*].

When you input a 0 V signal, the frequency reference will be -25%.

When *H3-01 = 0 [Terminal A1 Signal Level Select = 0 to 10V (Lower Limit at 0)]*, when you input a 0 V to 2 V signal, the frequency reference will be 0%. When you input a 2 V to 10 V signal, the frequency reference will be 0% to 100%.

When *H3-01 = 1 [-10 to +10V (Bipolar Reference)]*, it enables signals of positive and negative polarities. When you input a 0 V to 2 V signal, and the motor rotates in reverse.



**Figure 11.106 Frequency Reference When Negative Number Bias Is Configured**

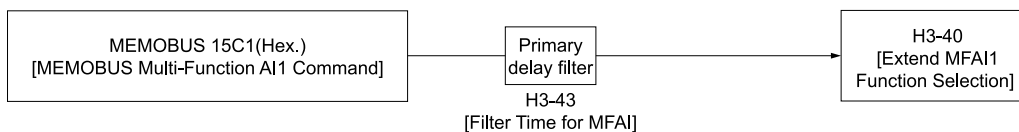
■ MEMOBUS/Modbus Multi-Function A11 to 3 Function Selection

Let the MFAI function be assigned to MEMOBUS/Modbus register *15C1 to 15C3 (Hex.) [Mbus Reg 15C1h through 15C3h Input Function]*. Use *H3-40 to H3-42 [Mbus Reg 15C1h through 15C3h Input Function]* to set the function and use *H3-43 [Mbus Reg Inputs FilterTime Const]* to set the input filter.

**Table 11.69 MEMOBUS Multi-Function AI Command Register**

Register No. (Hex.)	Name	Range *1	Parameter
15C1	Mbus Reg 15C1h Input Function	-32767 to 32767	H3-40
15C2	Mbus Reg 15C2h Input Function	-32767 to 32767	H3-41
15C3	Mbus Reg 15C3h Input Function	-32767 to 32767	H3-42

\*1 Set as 100% = 4096.



**Figure 11.107 Functional Block Diagram for MEMOBUS Multi-Function AI Command 1**



**Note:**

- Refer to H3-xx “MFAI Setting Values” for the analog input setting values.
- When you will not use the terminal, set H3-40 to H3-42 = F. The through mode function is not supported.
- You cannot use H3-40 to H3-42 to set these MFAI terminals:

H3-xx Setting Value	Function
0	Frequency Reference
1	Frequency Gain
2	Auxiliary Frequency Reference 1
3	Auxiliary Frequency Reference 2
30	DWEZ Analog Input 1
31	DWEZ Analog Input 2
32	DWEZ Analog Input 3

## ◆ H3: MFAI Parameters

### ■ H3-01: Terminal A1 Signal Level Select

No. (Hex.)	Name	Description	Default (Range)
H3-01 (0410)	Terminal A1 Signal Level Select	<div style="display: flex; gap: 5px;"> <span>V/f</span> <span>CL-V/f</span> <span>OLV</span> <span>CLV</span> <span>AOLV</span> <span>OLV/PM</span> <span>AOLV/PM</span> <span>CLV/PM</span> <span>EZOLV</span> </div> Sets the input signal level for MFAI terminal A1.	0 (0 - 3)

#### 0 : 0 to 10V (Lower Limit at 0)

The voltage signal is 0 Vdc to 10 Vdc. The minimum input level limit is 0%. The drive will read a negative input signal caused by gain and bias settings as 0%.

#### 1 : -10 to +10V (Bipolar Reference)

The voltage signal is -10 Vdc to 10 Vdc. This setting enables positive and negative polarity signals. When the drive uses this setting as the frequency reference, a Forward Run command will run the motor in reverse and a Reverse Run command will run the motor forward. The gain and bias settings will cause the signal to be a negative number.

#### 2 : 4 to 20 mA

The current signal is 4 mA to 20 mA. The minimum input level limit is 0%. The drive will read a negative input signal caused by gain and bias settings as 0%.

#### 3 : 0 to 20 mA

The current signal is 0 mA to 20 mA. The minimum input level limit is 0%. The drive will read a negative input signal caused by gain and bias settings as 0%.

**Note:**

When H3-01 = 0, 1, set DIP switch S1-1 to the V side (voltage). When H3-01 = 2, 3, set DIP switch S1-1 to the I side (current). The default setting is the V side (voltage).

### ■ H3-02: Terminal A1 Function Selection

No. (Hex.)	Name	Description	Default (Range)
H3-02 (0434)	Terminal A1 Function Selection	<div style="display: flex; gap: 5px;"> <span>V/f</span> <span>CL-V/f</span> <span>OLV</span> <span>CLV</span> <span>AOLV</span> <span>OLV/PM</span> <span>AOLV/PM</span> <span>CLV/PM</span> <span>EZOLV</span> </div> Sets a function for MFAI terminal A1.	0 (0 - 32)

### ■ H3-03: Terminal A1 Gain Setting

No. (Hex.)	Name	Description	Default (Range)
H3-03 (0411) RUN	Terminal A1 Gain Setting	<div style="display: flex; gap: 5px;"> <span>V/f</span> <span>CL-V/f</span> <span>OLV</span> <span>CLV</span> <span>AOLV</span> <span>OLV/PM</span> <span>AOLV/PM</span> <span>CLV/PM</span> <span>EZOLV</span> </div> Sets the gain of the analog signal input to MFAI terminal A1.	100.0% (-999.9 - +999.9%)

This parameter sets the quantity of reference for the function set for terminal A1 as a percentage when 10 V (or 20 mA) is input.

Use this parameter and H3-04 [Terminal A1 Bias Setting] to adjust the characteristics of the analog input signal to terminal A1.

■ **H3-04: Terminal A1 Bias Setting**

No. (Hex.)	Name	Description	Default (Range)
H3-04 (0412) RUN	Terminal A1 Bias Setting	<b>V/f</b> <b>CL-V/f</b> <b>OLV</b> <b>CLV</b> <b>AOLV</b> <b>OLV/PM</b> <b>AOLV/PM</b> <b>CLV/PM</b> <b>EZOLV</b> Sets the bias of the analog signal input to MFAI terminal A1.	0.0% (-999.9 - +999.9%)

This parameter sets the bias for the function set for terminal A1 as a percentage when 0 V (4 mA or 0 mA) is input.

Use this parameter and H3-03 [Terminal A1 Gain Setting] to adjust the characteristics of the analog input signal to terminal A1.

■ **H3-05: Terminal A3 Signal Level Select**

No. (Hex.)	Name	Description	Default (Range)
H3-05 (0413)	Terminal A3 Signal Level Select	<b>V/f</b> <b>CL-V/f</b> <b>OLV</b> <b>CLV</b> <b>AOLV</b> <b>OLV/PM</b> <b>AOLV/PM</b> <b>CLV/PM</b> <b>EZOLV</b> Sets the input signal level for MFAI terminal A3.	0 (0 - 3)

**0 : 0-10V (LowLim=0)**

The voltage signal is 0 Vdc to 10 Vdc. The minimum input level limit is 0%. The drive will read a negative input signal caused by gain and bias settings as 0%.

**1 : -10 to +10V (Bipolar Reference)**

The voltage signal is -10 Vdc to 10 Vdc. This setting enables positive and negative polarity signals. When the drive uses this setting as the frequency reference, a Forward Run command will run the motor in reverse and a Reverse Run command will run the motor forward. The gain and bias settings will cause the signal to be a negative number.

**2 : 4 to 20 mA**

The current signal is 4 mA to 20 mA. The minimum input level limit is 0%. The drive will read a negative input signal caused by gain and bias settings as 0%.

**3 : 0 to 20 mA**

The current signal is 0 mA to 20 mA. The minimum input level limit is 0%. The drive will read a negative input signal caused by gain and bias settings as 0%.

**Note:**

When H3-05 = 0, 1, set DIP switch S1-3 to the V side (voltage). When H3-05 = 2, 3, set DIP switch S1-3 to the I side (current). The default setting is the V side (voltage).

■ **H3-06: Terminal A3 Function Selection**

No. (Hex.)	Name	Description	Default (Range)
H3-06 (0414)	Terminal A3 Function Selection	<b>V/f</b> <b>CL-V/f</b> <b>OLV</b> <b>CLV</b> <b>AOLV</b> <b>OLV/PM</b> <b>AOLV/PM</b> <b>CLV/PM</b> <b>EZOLV</b> Sets a function for MFAI terminal A3.	2 (0 - 32)

**Note:**

- When terminal A3 is the PTC input terminal:
- Set H3-06 = E [Motor Temperature (PTC input)]
  - Set DIP switch S4 to the PTC side
  - Set DIP switch S1-3 to the V side

### ■ H3-07: Terminal A3 Gain Setting

No. (Hex.)	Name	Description	Default (Range)
H3-07 (0415) RUN	Terminal A3 Gain Setting	<b>V/f</b> <b>CL-V/f</b> <b>OLV</b> <b>CLV</b> <b>AOLV</b> <b>OLV/PM</b> <b>AOLV/PM</b> <b>CLV/PM</b> <b>EZOLV</b> Sets the gain of the analog signal input to MFAI terminal A3.	100.0% (-999.9 - +999.9%)

When 10 V (or 20 mA) is input, this parameter sets the reference quantity for the function set for terminal A3 as a percentage.

Use this parameter and H3-08 [Terminal A3 Bias Setting] to adjust the characteristics of the analog input signal to terminal A3.

### ■ H3-08: Terminal A3 Bias Setting

No. (Hex.)	Name	Description	Default (Range)
H3-08 (0416) RUN	Terminal A3 Bias Setting	<b>V/f</b> <b>CL-V/f</b> <b>OLV</b> <b>CLV</b> <b>AOLV</b> <b>OLV/PM</b> <b>AOLV/PM</b> <b>CLV/PM</b> <b>EZOLV</b> Sets the bias of the analog signal input to MFAI terminal A3.	0.0% (-999.9 - +999.9%)

When 0 V (4 mA or 0 mA) is input, this parameter sets the bias for the function set for terminal A3 as a percentage.

Use this parameter and H3-07 [Terminal A3 Gain Setting] to adjust the characteristics of the analog input signal to terminal A3.

### ■ H3-09: Terminal A2 Signal Level Select

No. (Hex.)	Name	Description	Default (Range)
H3-09 (0417)	Terminal A2 Signal Level Select	<b>V/f</b> <b>CL-V/f</b> <b>OLV</b> <b>CLV</b> <b>AOLV</b> <b>OLV/PM</b> <b>AOLV/PM</b> <b>CLV/PM</b> <b>EZOLV</b> Sets the input signal level for MFAI terminal A2.	2 (0 - 3)

#### 0 : 0-10V (LowLim=0)

The voltage signal is 0 Vdc to 10 Vdc. The minimum input level is limited to 0%, so that a negative input signal due to gain and bias settings will be read as 0%.

#### 1 : -10 to +10V (Bipolar Reference)

The voltage signal is -10 Vdc to 10 Vdc. Signals of both positive and negative polarities are enabled. When this setting is used as the frequency reference, the motor runs reverse when the Forward run command is input, or runs forward when the Reverse run signal is input, while the signal is a negative number due to gain and bias.

#### 2 : 4 to 20 mA

The current signal is 4 mA to 20 mA. The minimum input level is limited to 0%, so that a negative input signal due to gain and bias settings will be read as 0%.

#### 3 : 0 to 20 mA

The current signal is 0 mA to 20 mA. The minimum input level is limited to 0%, so that a negative input signal due to gain and bias settings will be read as 0%.

#### Note:

When H3-09 = 0, 1, set DIP switch S1-2 to the V side (voltage). When H3-09 = 2, 3, set DIP switch S1-2 to the I side (current). The default setting is the I side (current).

### ■ H3-10: Terminal A2 Function Selection

No. (Hex.)	Name	Description	Default (Range)
H3-10 (0418)	Terminal A2 Function Selection	<b>V/f</b> <b>CL-V/f</b> <b>OLV</b> <b>CLV</b> <b>AOLV</b> <b>OLV/PM</b> <b>AOLV/PM</b> <b>CLV/PM</b> <b>EZOLV</b> Sets a function for MFAI terminal A2.	0 (0 - 32)

### ■ H3-11: Terminal A2 Gain Setting

No. (Hex.)	Name	Description	Default (Range)
H3-11 (0419) RUN	Terminal A2 Gain Setting	<b>V/f</b> <b>CL-V/f</b> <b>OLV</b> <b>CLV</b> <b>AOLV</b> <b>OLV/PM</b> <b>AOLV/PM</b> <b>CLV/PM</b> <b>EZOLV</b> Sets the gain of the analog signal input to MFAI terminal A2.	100.0% (-999.9 - +999.9%)

When 10 V (or 20 mA) is input, this parameter sets the reference quantity for the function set for terminal A2 as a percentage.

Use this parameter and H3-12 [Terminal A2 Bias Setting] to adjust the characteristics of the analog input signal to terminal A2.

### ■ H3-12: Terminal A2 Bias Setting

No. (Hex.)	Name	Description	Default (Range)
H3-12 (041A) RUN	Terminal A2 Bias Setting	<b>V/f</b> <b>CL-V/f</b> <b>OLV</b> <b>CLV</b> <b>AOLV</b> <b>OLV/PM</b> <b>AOLV/PM</b> <b>CLV/PM</b> <b>EZOLV</b> Sets the bias of the analog signal input to MFAI terminal A2.	0.0% (-999.9 - +999.9%)

When 0 V (4 mA or 0 mA) is input, this parameter sets the bias for the function set for terminal A2 as a percentage.

Use this parameter and H3-11 [Terminal A2 Gain Setting] to adjust the characteristics of the analog input signal to terminal A2.

### ■ H3-13: Analog Input FilterTime Constant

No. (Hex.)	Name	Description	Default (Range)
H3-13 (041B)	Analog Input FilterTime Constant	<b>V/f</b> <b>CL-V/f</b> <b>OLV</b> <b>CLV</b> <b>AOLV</b> <b>OLV/PM</b> <b>AOLV/PM</b> <b>CLV/PM</b> <b>EZOLV</b> Sets the time constant to apply a primary delay filter to the MFAI terminal.	0.03 s (0.00 - 2.00 s)

Apply the primary delay filter to the analog input to enable an analog input signal without the use of high-frequency noise components. An analog input filter prevents irregular drive control. Drive operation becomes more stable as the programmed time becomes longer, but it also becomes less responsive to quickly changing analog signals.

### ■ H3-14: Analog Input Terminal Enable Sel

No. (Hex.)	Name	Description	Default (Range)
H3-14 (041C)	Analog Input Terminal Enable Sel	<b>V/f</b> <b>CL-V/f</b> <b>OLV</b> <b>CLV</b> <b>AOLV</b> <b>OLV/PM</b> <b>AOLV/PM</b> <b>CLV/PM</b> <b>EZOLV</b> Sets the enabled terminal or terminals when $H1-xx = C$ [MFDI Function Select = Analog Terminal Enable Selection] is ON.	7 (1 - 7)

Input signals do not have an effect on terminals not set as targets.

**1 : Terminal A1 only**

**2 : Terminal A2 only**

**3 : Terminals A1 and A2**

**4 : Terminal A3 only**

**5 : Terminals A1 and A3**

**6 : Terminals A2 and A3**

**7 : Terminals A1, A2, and A3**

**Note:**

- The ON/OFF operation of terminal Sx set in Analog Terminal Input Selection [ $H1-xx = C$ ] has an effect on only the analog input terminal selected with H3-14.
- When  $H1-xx \neq C$ , the functions set to terminals A1 to A3 are always enabled.

### ■ H3-16: Terminal A1 Offset

No. (Hex.)	Name	Description	Default (Range)
H3-16 (02F0)	Terminal A1 Offset	<b>V/f</b> <b>CL-V/f</b> <b>OLV</b> <b>CLV</b> <b>AOLV</b> <b>OLV/PM</b> <b>AOLV/PM</b> <b>CLV/PM</b> <b>EZOLV</b> Sets the offset level for analog signals input to terminal A1. Usually it is not necessary to change this setting.	0 (-500 - +500)

Adds the offset value for the analog input value. For voltage input, this parameter will set the offset when a signal of 0 V is input. For current input, this parameter will set the offset when a signal of 4 mA [H3-01 = 2] or 0 mA [H3-01 = 3] is input.

### ■ H3-17: Terminal A2 Offset

No. (Hex.)	Name	Description	Default (Range)
H3-17 (02F1)	Terminal A2 Offset	<b>V/f</b> <b>CL-V/f</b> <b>OLV</b> <b>CLV</b> <b>AOLV</b> <b>OLV/PM</b> <b>AOLV/PM</b> <b>CLV/PM</b> <b>EZOLV</b> Sets the offset level for analog signals input to terminal A2. Usually it is not necessary to change this setting.	0 (-500 - +500)

Adds the offset value for the analog input value. For voltage input, this parameter will set the offset when a signal of 0 V is input. For current input, this parameter will set the offset when a signal of 4 mA [H3-09 = 2] or 0 mA [H3-09 = 3] is input.

### ■ H3-18: Terminal A3 Offset

No. (Hex.)	Name	Description	Default (Range)
H3-18 (02F2)	Terminal A3 Offset	<b>V/f</b> <b>CL-V/f</b> <b>OLV</b> <b>CLV</b> <b>AOLV</b> <b>OLV/PM</b> <b>AOLV/PM</b> <b>CLV/PM</b> <b>EZOLV</b> Sets the offset level for analog signals input to terminal A3. Usually it is not necessary to change this setting.	0 (-500 - +500)

Adds the offset value for the analog input value. For voltage input, this parameter will set the offset when a signal of 0 V is input. For current input, this parameter will set the offset when a signal of 4 mA [H3-05 = 2] or 0 mA [H3-05 = 3] is input.

### ■ H3-40: Mbus Reg 15C1h Input Function

No. (Hex.)	Name	Description	Default (Range)
H3-40 (0B5C)	Mbus Reg 15C1h Input Function	<b>V/f</b> <b>CL-V/f</b> <b>OLV</b> <b>CLV</b> <b>AOLV</b> <b>OLV/PM</b> <b>AOLV/PM</b> <b>CLV/PM</b> <b>EZOLV</b> Sets the MEMOBUS AI1 function.	F (4 - 2F)

You can use the MFAI function from MEMOBUS/Modbus communications. Use this parameter to set the function. Sets the input for the function in MEMOBUS/Modbus register 15C1. Refer to H3-xx "MFAI Setting Values" for the setting values.

### ■ H3-41: Mbus Reg 15C2h Input Function

No. (Hex.)	Name	Description	Default (Range)
H3-41 (0B5F)	Mbus Reg 15C2h Input Function	<b>V/f</b> <b>CL-V/f</b> <b>OLV</b> <b>CLV</b> <b>AOLV</b> <b>OLV/PM</b> <b>AOLV/PM</b> <b>CLV/PM</b> <b>EZOLV</b> Sets the MEMOBUS AI2 function.	F (4 - 2F)

Refer to H3-xx "MFAI Setting Values" for the setting values.

### ■ H3-42: Mbus Reg 15C3h Input Function

No. (Hex.)	Name	Description	Default (Range)
H3-42 (0B62)	Mbus Reg 15C3h Input Function	<b>V/f</b> <b>CL-V/f</b> <b>OLV</b> <b>CLV</b> <b>AOLV</b> <b>OLV/PM</b> <b>AOLV/PM</b> <b>CLV/PM</b> <b>EZOLV</b> Sets the MEMOBUS AI3 function.	F (4 - 2F)

Refer to H3-xx "MFAI Setting Values" for the setting values.

■ **H3-43: Mbus Reg Inputs FilterTime Const**

No. (Hex.)	Name	Description	Default (Range)
H3-43 (117F)	Mbus Reg Inputs FilterTime Const	<span>V/f</span> <span>CL-V/f</span> <span>OLV</span> <span>CLV</span> <span>AOLV</span> <span>OLV/PM</span> <span>AOLV/PM</span> <span>CLV/PM</span> <span>EZOLV</span> Sets the time constant to apply a primary delay filter to the MEMOBUS analog input terminal.	0.00 s (0.00 - 2.00 s)

◆ **Multi-Function Analog Input Terminal Settings**

This section gives information about the functions set with *H3-02*, *H3-06*, and *H3-10*.

■ **0: Frequency Reference**

Setting	Function	Description
0	Frequency Reference	<span>V/f</span> <span>CL-V/f</span> <span>OLV</span> <span>CLV</span> <span>AOLV</span> <span>OLV/PM</span> <span>AOLV/PM</span> <span>CLV/PM</span> <span>EZOLV</span> The input value from the MFAI terminal set with this function becomes the master frequency reference.

- You can copy the configuration to more than one of the analog input terminals A1 through A3. When you set more than one analog input terminal with the master frequency reference, the sum value becomes the frequency bias.
- If you use this function to set the analog input value as the master frequency reference, set  $b1-01 = 1$  [*Frequency Reference Selection 1 = Analog Input*]. This setting value is the default value for terminals A1 and A2.
- The frequency reference is the sum of the input values for terminals A1 and A2 when they are used at the same time. For example, when a 20% bias is input to terminal A2 while a frequency reference of 50% is input from terminal A1, the calculated frequency reference will be 70% of the maximum output frequency.

■ **1: Frequency Gain**

Setting	Function	Description
1	Frequency Gain	<span>V/f</span> <span>CL-V/f</span> <span>OLV</span> <span>CLV</span> <span>AOLV</span> <span>OLV/PM</span> <span>AOLV/PM</span> <span>CLV/PM</span> <span>EZOLV</span> The drive multiplies the analog frequency reference with the input value from the MFAI set with this function.

Example:

- A 50% frequency gain is input to terminal A2
- A frequency reference of 80% is input from terminal A1
- The frequency gain is set to terminal 2

The calculated frequency reference is 40% of the maximum output frequency.

■ **2: Auxiliary Frequency Reference 1**

Setting	Function	Description
2	Auxiliary Frequency Reference 1	<span>V/f</span> <span>CL-V/f</span> <span>OLV</span> <span>CLV</span> <span>AOLV</span> <span>OLV/PM</span> <span>AOLV/PM</span> <span>CLV/PM</span> <span>EZOLV</span> Sets Reference 2 through multi-step speed reference to enable the command reference (Auxiliary Frequency Reference 1) from the analog input terminal set here. This value is a percentage where <i>E1-04 [Maximum Output Frequency]</i> setting is a setting value of 100%.

■ **3: Auxiliary Frequency Reference 2**

Setting	Function	Description
3	Auxiliary Frequency Reference 2	<span>V/f</span> <span>CL-V/f</span> <span>OLV</span> <span>CLV</span> <span>AOLV</span> <span>OLV/PM</span> <span>AOLV/PM</span> <span>CLV/PM</span> <span>EZOLV</span> Sets Reference 3 through multi-step speed reference to enable the command reference (Auxiliary Frequency Reference 2) from the analog input terminal set here. This value is a percentage where <i>E1-04 [Maximum Output Frequency]</i> setting is a setting value of 100%.

■ **4: Output Voltage Bias**

Setting	Function	Description
4	Output Voltage Bias	<span>V/f</span> <span>CL-V/f</span> <span>OLV</span> <span>CLV</span> <span>AOLV</span> <span>OLV/PM</span> <span>AOLV/PM</span> <span>CLV/PM</span> <span>EZOLV</span> Set this parameter to input a bias signal and amplify the output voltage.

The gain (%) for the MFAI terminals A1, A2, and A3 is 100% of the voltage class standard, which is 200 V for 200 V class drives and 400 V for 400 V class drives. The bias (%) for MFAI terminals A1, A2, and A3 is 100% of the voltage configured for *E1-05 [Maximum Output Voltage]*.

**Note:**

The gain for each terminal A1, A2, and A3 is configured independently with *H3-03 [Terminal A1 Gain Setting]*, *H3-11 [Terminal A2 Gain Setting]*, and *H3-07 [Terminal A3 Gain Setting]*. The bias for each terminal A1, A2, and A3 is configured independently with *H3-04 [Terminal A1 Bias Setting]*, *H3-12 [Terminal A2 Bias Setting]*, and *H3-08 [Terminal A3 Bias Setting]*.

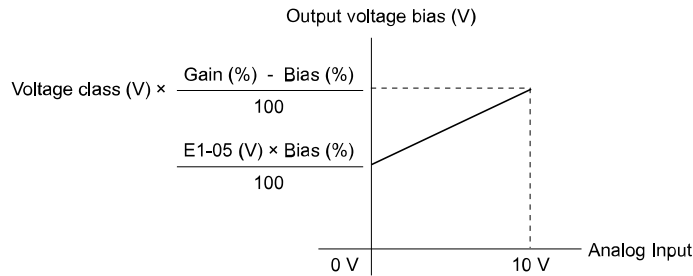


Figure 11.108 Output Voltage Bias through Analog Input

**5: Accel/Decel Time Gain**

Setting	Function	Description
5	Accel/Decel Time Gain	<div style="display: flex; justify-content: space-between; font-size: small;"> <span>V/f</span> <span>CL-V/f</span> <span>OLV</span> <span>CLV</span> <span>AOLV</span> <span>OLV/PM</span> <span>AOLV/PM</span> <span>CLV/PM</span> <span>EZOLV</span> </div> Enters a signal to adjust the gain used for <i>C1-01</i> to <i>C1-08 [Accel &amp; Decel Time 1 through 4]</i> if the full scale analog signal (10 V or 20 mA) is 100%.

When you enable *C1-01 [Acceleration Time 1]*, the acceleration time is:

$$\text{Acceleration Time 1} = C1-01 \text{ setting} \times \text{acceleration and deceleration time gain} / 100$$

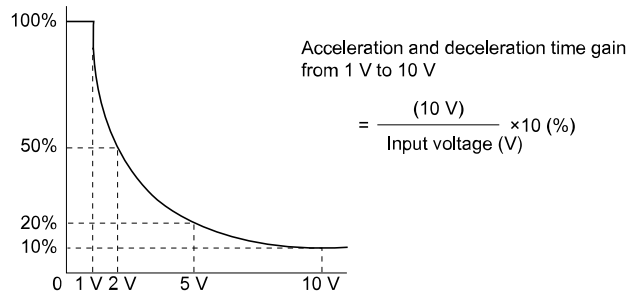


Figure 11.109 Acceleration/Deceleration Time Gain through Analog Input

**6: DC Injection Braking Current**

Setting	Function	Description
6	DC Injection Braking Current	<div style="display: flex; justify-content: space-between; font-size: small;"> <span>V/f</span> <span>CL-V/f</span> <span>OLV</span> <span>CLV</span> <span>AOLV</span> <span>OLV/PM</span> <span>AOLV/PM</span> <span>CLV/PM</span> <span>EZOLV</span> </div> Enters a signal to adjust the current level used for DC Injection Braking if the drive rated output current is 100%.

**Note:**

When you set this function, it will disable the setting value of *b2-02 [DC Injection Braking Current]*.

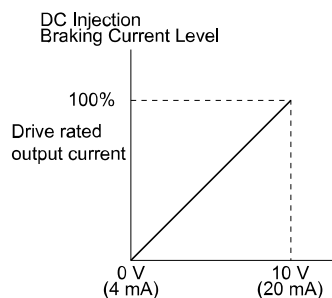


Figure 11.110 DC Injection Braking Current through Analog Input

**7: Torque Detection Level**

Setting	Function	Description
7	Torque Detection Level	<div style="display: flex; justify-content: space-between; font-size: small;"> <span>V/f</span> <span>CL-V/f</span> <span>OLV</span> <span>CLV</span> <span>AOLV</span> <span>OLV/PM</span> <span>AOLV/PM</span> <span>CLV/PM</span> <span>EZOLV</span> </div> Enters a signal to adjust the overtorque/undertorque detection level.

When  $A1-02 = 0, 1, 5$  [Control Method Selection = V/f Control, Closed Loop V/f Control, PM Open Loop Vector Control], the drive rated current is 100%. When  $A1-02 = 2, 3, 4, 6, 7, 8$  [Open Loop Vector Control, Closed Loop Vector Control, Advanced Open Loop Vector Control, PM Advanced Open Loop Vector, PM Closed Loop Vector Control, or EZ Open Loop Vector Control], the motor rated current is 100%.

**Note:**

Use this function with  $L6-01$  [Torque Detection Selection 1]. This parameter functions as an alternative to  $L6-02$  [Torque Detection Level 1].

**8: Stall Prevent Level During Run**

Setting Value	Function	Description
8	Stall Prevent Level During Run	<div style="display: flex; justify-content: space-between; font-size: small;"> <span>V/f</span> <span>CL-V/f</span> <span>OLV</span> <span>CLV</span> <span>AOLV</span> <span>OLV/PM</span> <span>AOLV/PM</span> <span>CLV/PM</span> <span>EZOLV</span> </div> Enters a signal to adjust the stall prevention level during run if the drive rated current is 100%.

**Note:**

The correct stall prevention level during run is the lower value between:

- The analog input value for the MFAI terminal, or
- The value of  $L3-06$  [Stall Prevent Level during Run].

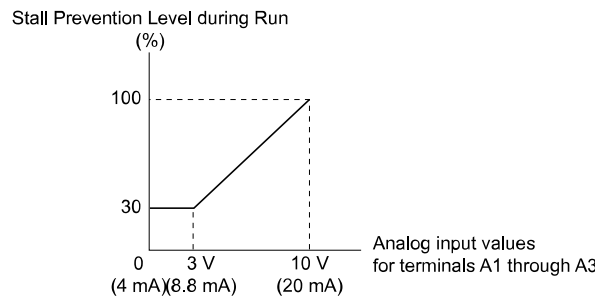


Figure 11.111 Stall Prevention Level during Run through Analog Input

**9: Output Frequency Lower Limit**

Setting	Function	Description
9	Output Frequency Lower Limit	<div style="display: flex; justify-content: space-between; font-size: small;"> <span>V/f</span> <span>CL-V/f</span> <span>OLV</span> <span>CLV</span> <span>AOLV</span> <span>OLV/PM</span> <span>AOLV/PM</span> <span>CLV/PM</span> <span>EZOLV</span> </div> Enters a signal to adjust the output frequency lower limit level if $E1-04$ [Maximum Output Frequency] = 100%.

**B: PID Feedback**

Setting	Function	Description
B	PID Feedback	<div style="display: flex; justify-content: space-between; font-size: small;"> <span>V/f</span> <span>CL-V/f</span> <span>OLV</span> <span>CLV</span> <span>AOLV</span> <span>OLV/PM</span> <span>AOLV/PM</span> <span>CLV/PM</span> <span>EZOLV</span> </div> Enters the PID feedback value.

Sets the current PID feedback value when the 10 V (or 20 mA) analog signal is input as 100%.

When you use this function, set  $b5-01 = 1$  to 8 [PID Function Setting = Enabled].

**C: PID Setpoint**

Setting	Function	Description
C	PID Setpoint	<div style="display: flex; justify-content: space-between; font-size: small;"> <span>V/f</span> <span>CL-V/f</span> <span>OLV</span> <span>CLV</span> <span>AOLV</span> <span>OLV/PM</span> <span>AOLV/PM</span> <span>CLV/PM</span> <span>EZOLV</span> </div> Enters the PID setpoint.

Sets the current PID setpoint value when the 10 V (or 20 mA) analog signal is input as 100%.

Set  $b5-01 = 1$  to 8 [PID Mode Setting = Enabled] when using this function.



**Note:**

Configuring this function disables the frequency reference set with *b1-01* [*Frequency Reference Selection 1*].

**■ D: Frequency Bias**

Setting	Function	Description
D	Frequency Bias	<div style="display: flex; justify-content: space-between; align-items: center;"> <span>V/f</span> <span>CL-V/f</span> <span>OLV</span> <span>CLV</span> <span>AOLV</span> <span>OLV/PM</span> <span>AOLV/PM</span> <span>CLV/PM</span> <span>EZOLV</span> </div> <p>Enters the bias value added to the frequency reference if <i>E1-04</i> [<i>Maximum Output Frequency</i>] is 100%.</p>

The drive adds the input value from the MFAI terminal set with this function to the frequency reference as the bias value. If you select *d1-xx* as the frequency reference, it will disable this function.

**■ E: Motor Temperature (PTC Input)**

Setting	Function	Description
E	Motor Temperature (PTC Input)	<div style="display: flex; justify-content: space-between; align-items: center;"> <span>V/f</span> <span>CL-V/f</span> <span>OLV</span> <span>CLV</span> <span>AOLV</span> <span>OLV/PM</span> <span>AOLV/PM</span> <span>CLV/PM</span> <span>EZOLV</span> </div> <p>Uses the motor Positive Temperature Coefficient (PTC) thermistor to prevent heat damage to the motor if the current value when the 10 V (or 20 mA) analog signal is input is 100%.</p>

- You can use the Positive Temperature Coefficient (PLC) thermistor as an auxiliary or alternative detection function for *oL1* [*Motor Overload*] problems to help prevent heat damage to motors. If the PTC input signal is more than the overload alarm level, *oH3* [*Motor Overheating Alarm*] will flash on the keypad.
- When the drive detects *oH3*, the motor stops with the setting in *L1-03*. When the drive detects *oH4*, the motor stops with the setting in *L1-04*. When the drive incorrectly detects motor overheating problems, set *L1-05*.

**■ F: Not Used**

Setting	Function	Description
F	Not Used	<div style="display: flex; justify-content: space-between; align-items: center;"> <span>V/f</span> <span>CL-V/f</span> <span>OLV</span> <span>CLV</span> <span>AOLV</span> <span>OLV/PM</span> <span>AOLV/PM</span> <span>CLV/PM</span> <span>EZOLV</span> </div> <p>Value for terminals that are not being used or terminals being used in through mode.</p>

When you set a terminal that is not in use to F, you can use the signal input to the terminal as PLC analog signal input through MEMOBUS/Modbus communications or the communication option. This input signal does not have an effect on drive operation. This functions the same as setting 1F (Through Mode).

**■ 10: Forward Torque Limit**

Setting	Function	Description
10	Forward Torque Limit	<div style="display: flex; justify-content: space-between; align-items: center;"> <span>V/f</span> <span>CL-V/f</span> <span>OLV</span> <span>CLV</span> <span>AOLV</span> <span>OLV/PM</span> <span>AOLV/PM</span> <span>CLV/PM</span> <span>EZOLV</span> </div> <p>Enters the forward torque limit if the motor rated torque is 100%.</p>

**WARNING!** *Sudden Movement Hazard. Set correct torque limits for applications, for example elevator applications. If you set torque limits incorrectly, motor torque that is not sufficient can cause damage to equipment and cause serious injury or death.*

**Torque Limit Configuration Method**

Use one of these methods to set torque limits:

- Use *L7-01* to *L7-04* [*Torque Limit*] to set each of the 4 torque limit quadrants.
- Use MFAIs to set each of the 4 torque limit quadrants. Set *H3-02*, *H3-06*, or *H3-10* [*MFAI Function Select*] to *10*, *11*, or *12* [*Forward/Reverse/Regenerative Torque Limit*].
- Use MFAIs to set all 4 torque limit quadrants at one time. Set *H3-02*, *H3-06*, or *H3-10* to *15* [*General Torque Limit*].

Figure 11.112 shows the configuration method for each quadrant.

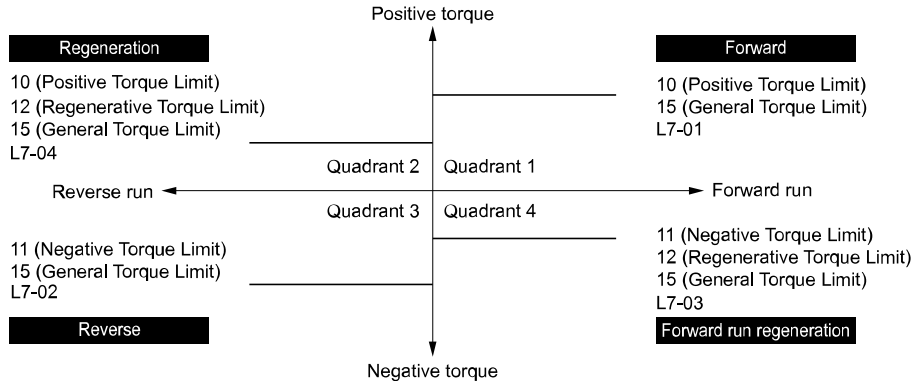


Figure 11.112 Torque Limits and Analog Input Settings Parameters

**Note:**

- When you use L7-01 to L7-04 and analog inputs to set torque limits for the same quadrant, it will enable the lower torque limit. In this example of parameter settings, the torque limit for quadrant 1 is 130% and the torque limit for quadrants 2, 3, and 4 is 150%: Settings: L7-01 = 130%; L7-02 to L7-04 = 200%; and MFAI torque limit = 150%
- The output current of the drive limits the maximum output torque. The torque limit is 150% of the rated output current for HD and to 120% of the rated output current for ND. The actual output torque cannot be more than the limit of the drive rated output current, although the torque limit is high.

If you use drives in applications where the vertical axis can fall, make sure that you know these items:

- Correctly configure drives and motors.
- Correctly set parameters.
- You can change parameter values after you do Auto-Tuning.
- Use a system that will not let the vertical axis fall if the drive fails.

Figure 11.113 shows the relation between torque limits from parameters and torque limits from analog input.

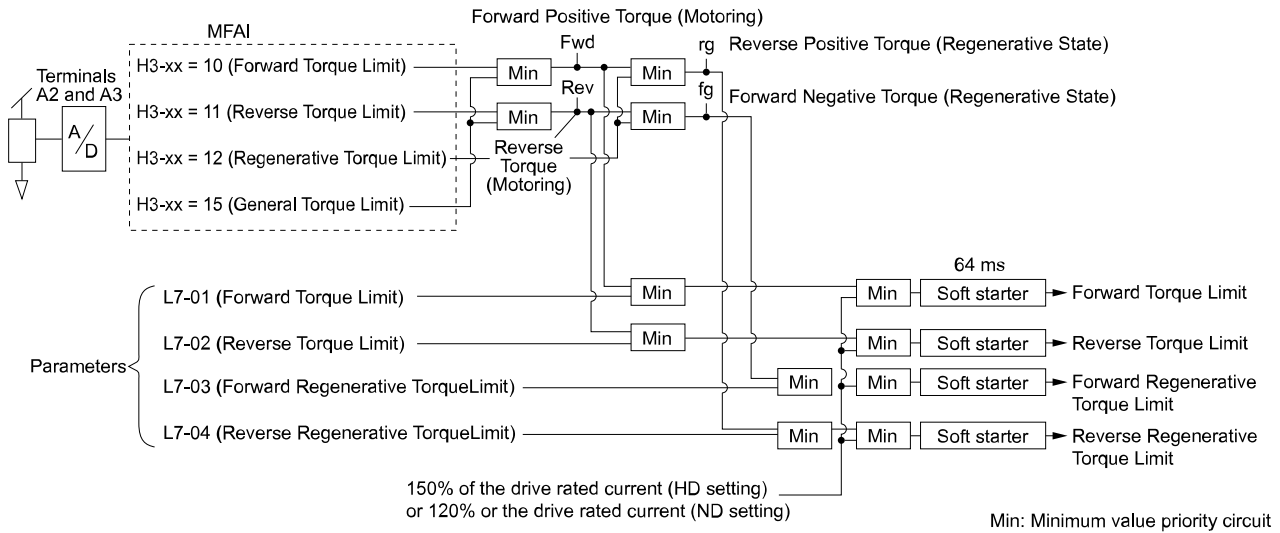


Figure 11.113 Torque Limits from Parameters and Analog Inputs

■ 11: Reverse Torque Limit

Setting	Function	Description
11	Reverse Torque Limit	V/f CL-V/f OLV CLV AOLV OLV/PM AOLV/PM CLV/PM EZOLV Enters the load torque limit if the motor rated torque is 100%.

**Note:**

When you use L7-01 to L7-04 and analog inputs to set torque limits for the same quadrant, it will enable the lower torque limit.

■ 12: Regenerative Torque Limit

Setting	Function	Description
12	Regenerative Torque Limit	V/f CL-V/f OLV CLV AOLV OLV/PM AOLV/PM CLV/PM EZOLV Enters the regenerative torque limit if the motor rated torque is 100%.

**Note:**

When you use L7-01 to L7-04 and analog inputs to set torque limits for the same quadrant, it will enable the lower torque limit.

**■ 13: Torque Reference / Torque Limit**

Setting	Function	Description
13	Torque Reference / Torque Limit	<input type="checkbox"/> V/f <input type="checkbox"/> CL-V/f <input type="checkbox"/> OLV <input checked="" type="checkbox"/> CLV <input type="checkbox"/> AOLV <input type="checkbox"/> OLV/PM <input type="checkbox"/> AOLV/PM <input type="checkbox"/> CLV/PM <input type="checkbox"/> EZOLV Enters the torque reference if the motor rated torque is 100%. This setting is the torque limit for speed control.

**Note:**

When you use L7-01 to L7-04 and analog inputs to set torque limits for the same quadrant, it will enable the lower torque limit.

**■ 14: Torque Compensation**

Setting	Function	Description
14	Torque Compensation	<input type="checkbox"/> V/f <input type="checkbox"/> CL-V/f <input type="checkbox"/> OLV <input checked="" type="checkbox"/> CLV <input type="checkbox"/> AOLV <input type="checkbox"/> OLV/PM <input type="checkbox"/> AOLV/PM <input type="checkbox"/> CLV/PM <input type="checkbox"/> EZOLV Enters the torque compensation value if the motor rated torque is 100%.

**■ 15: General Torque Limit**

Setting	Function	Description
15	General Torque Limit	<input type="checkbox"/> V/f <input type="checkbox"/> CL-V/f <input type="checkbox"/> OLV <input checked="" type="checkbox"/> CLV <input type="checkbox"/> AOLV <input type="checkbox"/> OLV/PM <input type="checkbox"/> AOLV/PM <input type="checkbox"/> CLV/PM <input type="checkbox"/> EZOLV Enters the torque limit that is the same for all quadrants for forward, reverse, and regenerative operation if the motor rated torque is 100%.

**■ 16: Differential PID Feedback**

Setting	Function	Description
16	Differential PID Feedback	<input checked="" type="checkbox"/> V/f <input type="checkbox"/> CL-V/f <input type="checkbox"/> OLV <input type="checkbox"/> CLV <input type="checkbox"/> AOLV <input type="checkbox"/> OLV/PM <input type="checkbox"/> AOLV/PM <input type="checkbox"/> CLV/PM <input type="checkbox"/> EZOLV Enters the PID differential feedback value if the full scale analog signal (10 V or 20 mA) is 100%.

The drive uses the deviation between the PID feedback and the differential feedback value signals to calculate the PID input.

**■ 1F: Not Used**

Setting	Function	Description
1F	Not Used	<input type="checkbox"/> V/f <input type="checkbox"/> CL-V/f <input type="checkbox"/> OLV <input type="checkbox"/> CLV <input type="checkbox"/> AOLV <input type="checkbox"/> OLV/PM <input type="checkbox"/> AOLV/PM <input type="checkbox"/> CLV/PM <input type="checkbox"/> EZOLV Value for terminals that are not being used or terminals being used in through mode.

When you set a terminal that you do not use to 1F, you can use the signal that is input to that terminal as the PLC analog signal input from MEMOBUS/Modbus communications or the communication option. This input signal does not have an effect on drive operation. This signal functions the same as F (Through Mode).

**■ 30: DWEZ Analog Input 1**

Setting	Function	Description
30	DWEZ Analog Input 1	<input type="checkbox"/> V/f <input type="checkbox"/> CL-V/f <input type="checkbox"/> OLV <input type="checkbox"/> CLV <input type="checkbox"/> AOLV <input type="checkbox"/> OLV/PM <input type="checkbox"/> AOLV/PM <input type="checkbox"/> CLV/PM <input type="checkbox"/> EZOLV Use with DriveWorksEZ. Refer to the DriveWorksEZ online manual for more information.

**■ 31: DWEZ Analog Input 2**

Setting	Function	Description
31	DWEZ Analog Input 2	<input type="checkbox"/> V/f <input type="checkbox"/> CL-V/f <input type="checkbox"/> OLV <input type="checkbox"/> CLV <input type="checkbox"/> AOLV <input type="checkbox"/> OLV/PM <input type="checkbox"/> AOLV/PM <input type="checkbox"/> CLV/PM <input type="checkbox"/> EZOLV Use with DriveWorksEZ. Refer to the DriveWorksEZ online manual for more information.

**■ 32: DWEZ Analog Input 3**

Setting	Function	Description
32	DWEZ Analog Input 3	<input type="checkbox"/> V/f <input type="checkbox"/> CL-V/f <input type="checkbox"/> OLV <input type="checkbox"/> CLV <input type="checkbox"/> AOLV <input type="checkbox"/> OLV/PM <input type="checkbox"/> AOLV/PM <input type="checkbox"/> CLV/PM <input type="checkbox"/> EZOLV Use with DriveWorksEZ. Refer to the DriveWorksEZ online manual for more information.

### ◆ H4: Analog Outputs

H4 parameters set the drive analog monitors. These parameters select monitor parameters, adjust gain and bias, and select output signal levels.

#### ■ Calibrate Meters Connected to MFAO Terminals FM and AM

You can use H4-02, H4-03, H4-05, and H4-06 [FM/AM Analog Output Gain/Bias] to calibrate meters connected to terminals FM and AM.

No.	Name	Setting Range	Default Setting
H4-02	Terminal FM Analog Output Gain	-999.9 - 999.9%	100.0%
H4-03	Terminal FM Analog Output Bias	-999.9 - 999.9%	0.0%
H4-05	Terminal AM Analog Output Gain	-999.9 - 999.9%	50.0%
H4-06	Terminal AM Analog Output Bias	-999.9 - 999.9%	0.0%
H4-07	Terminal FM Signal Level Select	0: 0-10 VDC 1: -10 +10 VDC 2: 4-20 mA	0
H4-08	Terminal AM Signal Level Select	0: 0-10 VDC 1: -10 +10 VDC 2: 4-20 mA	0

Figure 11.114 shows the gain and bias.

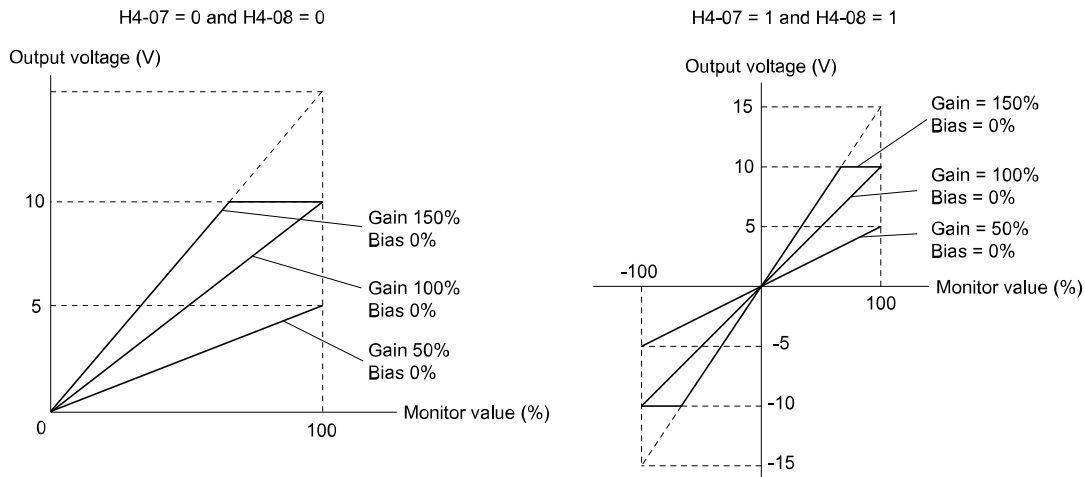


Figure 11.114 Analog Output Gain/Bias Configuration Example 1

For example, when the parameter value set to analog output is 0, and a 3 V signal is output to terminal FM, H4-03 [FM Analog Output Bias] is set to 30%.

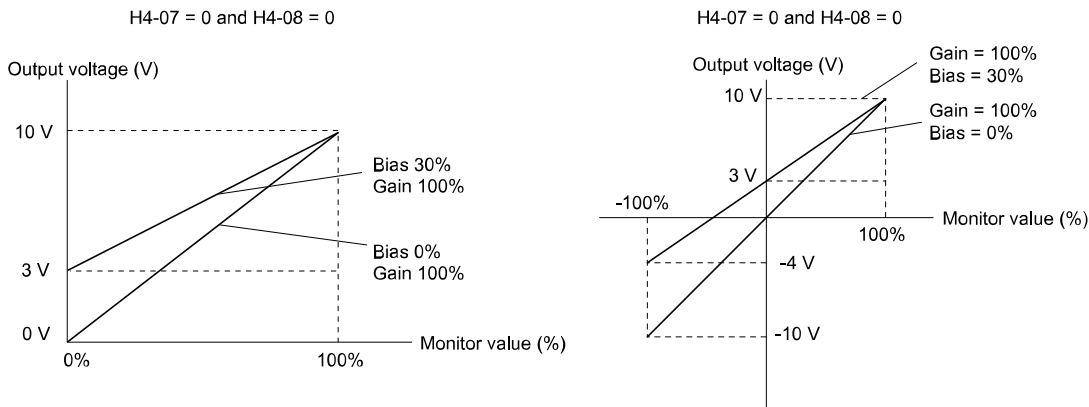


Figure 11.115 Analog Output Gain/Bias Configuration Example 2

#### Calibrate Terminal FM

Stop the drive to calibrate meters. Use this procedure to calibrate:

1. Show H4-02 [FM Analog Output Gain] on the keypad.

Terminal FM outputs the analog signal when the monitor item that you set in *H4-01 [MFAO Terminal FM Monitor Select]* is 100%.

- Adjust *H4-02* and monitor the meter scale connected to terminal FM.
- Show *H4-03 [FM Analog Output Bias]* on the keypad.  
The analog signal at the time when the monitor item selected with *H4-01* is 0% is output from terminal FM.
- Adjust *H4-03* while referencing the meter scale connected to terminal FM.

### Calibrate Terminal AM

Stop the drive to calibrate meters. Use this procedure to calibrate:

- Show *H4-05 [AM Analog Output Gain]* on the keypad.  
Terminal AM outputs the analog signal when the monitor item that you set in *H4-04 [MFAO Terminal AM Monitor Select]* is 100%.
- Adjust *H4-05* and monitor the meter scale connected to terminal AM.
- Show *H4-06 [AM Analog Output Bias]* on the keypad.  
Terminal AM outputs the analog signal when the monitor item that you set in *H4-04 [MFAO Terminal AM Monitor Select]* is 0%.
- Adjust *H4-03* and monitor the meter scale connected to terminal FM.

### ■ H4-01: Terminal FM Analog Output Select

No. (Hex.)	Name	Description	Default (Range)
H4-01 (041D)	Terminal FM Analog Output Select	<b>V/f</b> <b>CL-V/f</b> <b>OLV</b> <b>CLV</b> <b>AOLV</b> <b>OLV/PM</b> <b>AOLV/PM</b> <b>CLV/PM</b> <b>EZOLV</b> Sets the monitor number to send from MFAO terminal FM.	102 (000 - 999)

Set the *x-xx* part of the *Ux-xx [Monitor]*. For example, set *H4-01* to 102 to monitor *U1-02 [Output Frequency]*.

#### Note:

- The configurable monitor changes when the control method changes.
- To use in through mode, set this parameter to 000 or 031. You can set the terminal FM output level from the PLC through MEMOBUS/Modbus communications or the communication option.

### ■ H4-02: Terminal FM Analog Output Gain

No. (Hex.)	Name	Description	Default (Range)
H4-02 (041E) RUN	Terminal FM Analog Output Gain	<b>V/f</b> <b>CL-V/f</b> <b>OLV</b> <b>CLV</b> <b>AOLV</b> <b>OLV/PM</b> <b>AOLV/PM</b> <b>CLV/PM</b> <b>EZOLV</b> Sets the gain of the monitor signal that is sent from MFAO terminal FM.	100.0% (-999.9 - +999.9%)

The analog signal output from the FM terminal is a maximum of  $\pm 10$  V (or 20 mA). Select the signal level with *H4-07 [Terminal FM Signal Level Select]*.

### ■ H4-03: Terminal FM Analog Output Bias

No. (Hex.)	Name	Description	Default (Range)
H4-03 (041F) RUN	Terminal FM Analog Output Bias	<b>V/f</b> <b>CL-V/f</b> <b>OLV</b> <b>CLV</b> <b>AOLV</b> <b>OLV/PM</b> <b>AOLV/PM</b> <b>CLV/PM</b> <b>EZOLV</b> Sets the bias of the monitor signal that is sent from MFAO terminal FM.	0.0% (-999.9 - +999.9%)

The analog signal output from the FM terminal is a maximum of  $\pm 10$  V (or 20 mA). Select the signal level with *H4-07 [Terminal FM Signal Level Select]*.

### ■ H4-04: Terminal AM Analog Output Select

No. (Hex.)	Name	Description	Default (Range)
H4-04 (0420)	Terminal AM Analog Output Select	<b>V/f</b> <b>CL-V/f</b> <b>OLV</b> <b>CLV</b> <b>AOLV</b> <b>OLV/PM</b> <b>AOLV/PM</b> <b>CLV/PM</b> <b>EZOLV</b> Sets the monitoring number to be output from the MFAO terminal AM.	103 (000 - 999)

Set the *x-xx* part of the *Ux-xx [Monitor]*. For example, set *H4-04* to 102 to monitor *U1-02 [Output Frequency]*.

**Note:**

- The configurable monitor changes when the control method changes.
- To use in through mode, set this parameter to 000 or 031. You can set the terminal AM output level from the PLC through MEMOBUS/Modbus communications or the communication option.

■ **H4-05: Terminal AM Analog Output Gain**

No. (Hex.)	Name	Description	Default (Range)
H4-05 (0421) RUN	Terminal AM Analog Output Gain	<b>V/f</b> <b>CL-V/f</b> <b>OLV</b> <b>CLV</b> <b>AOLV</b> <b>OLV/PM</b> <b>AOLV/PM</b> <b>CLV/PM</b> <b>EZOLV</b> Sets the gain of the monitor signal that is sent from MFAO terminal AM.	50.0% (-999.9 - +999.9%)

The analog signal output from the AM terminal is a maximum of ±10 V (or 20 mA). Select the signal level with H4-08 [Terminal AM Signal Level Select].

Examples of possible settings:

When the output current of a monitoring item is 100% (drive rated current) in these examples, the voltage of AM terminal outputs at 5 V (50% of 10 V). Subsequently, the output current at the time the AM terminal outputs a maximum voltage of 10 V will be 200% of the drive rated current.

- H4-04 = 103 [Terminal AM Analog Output Select = Output Current]
- H4-05 = 50.0%
- H4-06 = 0.0% [Terminal AM Analog Output Bias = 0.0%]
- H4-08 = 0 [0 to 10 V]

■ **H4-06: Terminal AM Analog Output Bias**

No. (Hex.)	Name	Description	Default (Range)
H4-06 (0422) RUN	Terminal AM Analog Output Bias	<b>V/f</b> <b>CL-V/f</b> <b>OLV</b> <b>CLV</b> <b>AOLV</b> <b>OLV/PM</b> <b>AOLV/PM</b> <b>CLV/PM</b> <b>EZOLV</b> Sets the bias of the monitor signal that is sent from MFAO terminal AM.	0.0% (-999.9 - +999.9%)

The analog signal output from the AM terminal is a maximum of ±10 V (or 20 mA). Select the signal level with H4-08 [Terminal AM Signal Level Select].

■ **H4-07: Terminal FM Signal Level Select**

No. (Hex.)	Name	Description	Default (Range)
H4-07 (0423)	Terminal FM Signal Level Select	<b>V/f</b> <b>CL-V/f</b> <b>OLV</b> <b>CLV</b> <b>AOLV</b> <b>OLV/PM</b> <b>AOLV/PM</b> <b>CLV/PM</b> <b>EZOLV</b> Sets the MFAO terminal FM output signal level.	0 (0 - 2)

**Note:**

Set jumper S5 on the control circuit terminal block accordingly when changing these parameters.

**0 : 0-10 VDC**

**1 : -10 +10 VDC**

**2 : 4-20 mA**

■ **H4-08: Terminal AM Signal Level Select**

No. (Hex.)	Name	Description	Default (Range)
H4-08 (0424)	Terminal AM Signal Level Select	<b>V/f</b> <b>CL-V/f</b> <b>OLV</b> <b>CLV</b> <b>AOLV</b> <b>OLV/PM</b> <b>AOLV/PM</b> <b>CLV/PM</b> <b>EZOLV</b> Sets the MFAO terminal AM output signal level.	0 (0 - 2)

**Note:**

Set jumper S5 on the terminal board to the correct position after changing this parameter.

**0 : 0-10 VDC**

**1 : -10 +10 VDC**

**2 : 4-20 mA**

## ■ H4-20: Analog Power Monitor 100% Level

No. (Hex.)	Name	Description	Default (Range)
H4-20 (0B53)	Analog Power Monitor 100% Level	<b>V/f</b> <b>CL-V/f</b> <b>OLV</b> <b>CLV</b> <b>AOLV</b> <b>OLV/PM</b> <b>AOLV/PM</b> <b>CLV/PM</b> <b>EZOLV</b> Sets the level at 10 V when U1-08 [Output Power] is set for analog output.	0.00 kW (0.00 - 650.00 kW)

### Note:

- When H4-20 = 0.00 kW, the output power monitor 10 V level = motor rated power (kW). The A1-02 [Control Method Selection] setting sets the motor rated power:
  - A1-02 = 0, 1 [V/f Control, V/f Control with Encoder]: E2-11 [Motor Rated Power (kW)]
  - A1-02 = 2, 3, 4 [Open Loop Vector, Closed Loop Vector, Advanced Open Loop Vector]: E2-11 [Motor Rated Power (kW)]
  - A1-02 = 5, 6, 7 [PM Open Loop Vector, PM Advanced Open Loop Vector, PM Closed Loop Vector]: E5-02 [PM Motor Rated Power (kW)]
  - A1-02 = 8 [EZ Vector Control]: E9-07 [Motor Rated Power (kW)]

## ◆ H5: Memobus/Modbus Communication

H5 parameters configure the drive to use MEMOBUS/Modbus communications.

You can use the MEMOBUS/Modbus protocol over the RS-485 port (terminals D+ and D-) in the drive to use serial communication with programmable controllers (PLC).

### ■ H5-01: Drive Node Address

No. (Hex.)	Name	Description	Default (Range)
H5-01 (0425)	Drive Node Address	<b>V/f</b> <b>CL-V/f</b> <b>OLV</b> <b>CLV</b> <b>AOLV</b> <b>OLV/PM</b> <b>AOLV/PM</b> <b>CLV/PM</b> <b>EZOLV</b> Sets the communication slave address for drives.	1FH (0 - FFH)

### Note:

- Restart the drive after changing the parameter setting.
- Setting 0 will not let the drive respond to MEMOBUS/Modbus communications.

To enable the drive to communicate with the controller (master) over MEMOBUS/Modbus communications, you must set the drive with a slave address. Set H5-01 ≠ 0.

Set a slave address that is different from other slave devices.

### ■ H5-02: Communication Speed Selection

No. (Hex.)	Name	Description	Default (Range)
H5-02 (0426)	Communication Speed Selection	<b>V/f</b> <b>CL-V/f</b> <b>OLV</b> <b>CLV</b> <b>AOLV</b> <b>OLV/PM</b> <b>AOLV/PM</b> <b>CLV/PM</b> <b>EZOLV</b> Sets the communications speed for MEMOBUS/Modbus communications.	3 (0 - 8)

### Note:

Restart the drive after you change the parameter setting.

- 0 : 1200 bps
- 1 : 2400 bps
- 2 : 4800 bps
- 3 : 9600 bps
- 4 : 19.2 kbps
- 5 : 38.4 kbps
- 6 : 57.6 kbps
- 7 : 76.8 kbps
- 8 : 115.2 kbps

### ■ H5-03: Communication Parity Selection

No. (Hex.)	Name	Description	Default (Range)
H5-03 (0427)	Communication Parity Selection	<div style="display: flex; justify-content: space-between; font-size: small;"> <span>V/f</span> <span>CL-V/f</span> <span>OLV</span> <span>CLV</span> <span>AOLV</span> <span>OLV/PM</span> <span>AOLV/PM</span> <span>CLV/PM</span> <span>EZOLV</span> </div> Sets the communications parity used for MEMOBUS/Modbus communications.	0 (0 - 2)

**Note:**

Restart the drive after you change the parameter setting.

**0 : No parity**

**1 : Even parity**

**2 : Odd parity**

### ■ H5-04: Communication Error Stop Method

No. (Hex.)	Name	Description	Default (Range)
H5-04 (0428)	Communication Error Stop Method	<div style="display: flex; justify-content: space-between; font-size: small;"> <span>V/f</span> <span>CL-V/f</span> <span>OLV</span> <span>CLV</span> <span>AOLV</span> <span>OLV/PM</span> <span>AOLV/PM</span> <span>CLV/PM</span> <span>EZOLV</span> </div> Sets the motor Stopping Method when the drive detects <i>CE [Modbus Communication Error]</i> issues.	3 (0 - 3)

**0 : Ramp to Stop**

The drive ramps to stop in the selected deceleration time. Fault relay output terminal MA-MC will activate, and MB-MC will deactivate.

**1 : Coast to Stop**

The drive output shuts off and the motor coasts to stop. Fault relay output terminal MA-MC will activate, and MB-MC will deactivate.

**2 : Fast Stop (Use C1-09)**

The drive uses the deceleration time set in *C1-09 [Fast Stop Time]* to stop the motor. Fault relay output terminal MA-MC will activate, and MB-MC will deactivate.

**3 : Alarm Only**

*CE* is shown on the keypad and operation continues. The output terminal set for *Alarm [H2-01 to H2-03 = 10]* activates.

### ■ H5-05: Comm Fault Detection Selection

No. (Hex.)	Name	Description	Default (Range)
H5-05 (0429)	Comm Fault Detection Selection	<div style="display: flex; justify-content: space-between; font-size: small;"> <span>V/f</span> <span>CL-V/f</span> <span>OLV</span> <span>CLV</span> <span>AOLV</span> <span>OLV/PM</span> <span>AOLV/PM</span> <span>CLV/PM</span> <span>EZOLV</span> </div> Sets the function that detects <i>CE [Modbus Communication Error]</i> issues during MEMOBUS/Modbus communications.	1 (0, 1)

If the drive does not receive data from the master during the time set in *H5-09 [CE Detection Time]*, it will detect a *CE* error.

**0 : Disabled**

Does not detect *CE*. The drive continues operation.

**1 : Enabled**

Detects *CE*. If the drive detects *CE*, it will operate as specified by the setting of *H5-04 [Communication Error Stop Method]*.

### ■ H5-06: Drive Transmit Wait Time

No. (Hex.)	Name	Description	Default (Range)
H5-06 (042A)	Drive Transmit Wait Time	<div style="display: flex; justify-content: space-between; font-size: small;"> <span>V/f</span> <span>CL-V/f</span> <span>OLV</span> <span>CLV</span> <span>AOLV</span> <span>OLV/PM</span> <span>AOLV/PM</span> <span>CLV/PM</span> <span>EZOLV</span> </div> Sets the time to wait to send a response message after the drive receives a command message from the master.	5 ms (0 - 65 ms)



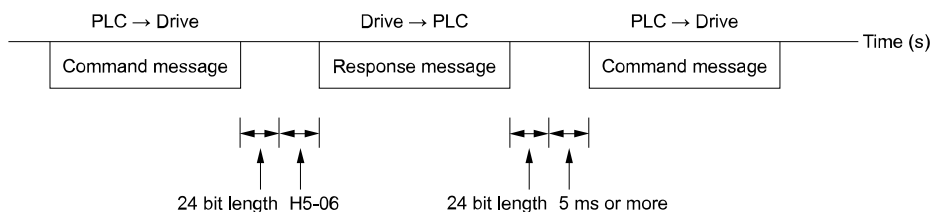


Figure 11.116 Drive Transmit Wait Time

### ■ H5-09: CE Detection Time

No. (Hex.)	Name	Description	Default (Range)
H5-09 (0435)	CE Detection Time	<input type="checkbox"/> V/f <input type="checkbox"/> CL-V/f <input type="checkbox"/> OLV <input type="checkbox"/> CLV <input type="checkbox"/> AOLV <input type="checkbox"/> OLV/PM <input type="checkbox"/> AOLV/PM <input type="checkbox"/> CLV/PM <input type="checkbox"/> EZOLV Sets the detection time for <i>CE [Modbus Communication Error]</i> issues when communication stops.	2.0 s (0.0 - 10.0 s)

### ■ H5-10: Modbus Register 0025H Unit Sel

No. (Hex.)	Name	Description	Default (Range)
H5-10 (0436)	Modbus Register 0025H Unit Sel	<input type="checkbox"/> V/f <input type="checkbox"/> CL-V/f <input type="checkbox"/> OLV <input type="checkbox"/> CLV <input type="checkbox"/> AOLV <input type="checkbox"/> OLV/PM <input type="checkbox"/> AOLV/PM <input type="checkbox"/> CLV/PM <input type="checkbox"/> EZOLV Sets the unit of measure used for the MEMOBUS/Modbus communications monitor register 0025H (output voltage reference monitor).	0 (0, 1)

**0** : 0.1 V units

**1** : 1 V units

### ■ H5-11: Comm ENTER Command Mode

No. (Hex.)	Name	Description	Default (Range)
H5-11 (043C)	Comm ENTER Command Mode	<input type="checkbox"/> V/f <input type="checkbox"/> CL-V/f <input type="checkbox"/> OLV <input type="checkbox"/> CLV <input type="checkbox"/> AOLV <input type="checkbox"/> OLV/PM <input type="checkbox"/> AOLV/PM <input type="checkbox"/> CLV/PM <input type="checkbox"/> EZOLV Sets the function to make the Enter command necessary to change parameters through MEMOBUS/Modbus communications.	0 (0, 1)

**0** : ENTER Command Required

You must use the Enter command to enable changes to parameters. Make all parameter changes then input the Enter command.

**1** : ENTER Command Not Required

It is not necessary to input the Enter command to change parameters.

### ■ H5-12: Run Command Method Selection

No. (Hex.)	Name	Description	Default (Range)
H5-12 (043D)	Run Command Method Selection	<input type="checkbox"/> V/f <input type="checkbox"/> CL-V/f <input type="checkbox"/> OLV <input type="checkbox"/> CLV <input type="checkbox"/> AOLV <input type="checkbox"/> OLV/PM <input type="checkbox"/> AOLV/PM <input type="checkbox"/> CLV/PM <input type="checkbox"/> EZOLV Sets the input method for the Run command when $b1-02 = 2$ [ <i>Run Command Selection 1 = Memobus/Modbus Communications</i> ] or $b1-16 = 2$ [ <i>Run Command Selection 2 = Memobus/Modbus Communications</i> ].	0 (0, 1)

**0** : FWD/Stop, REV/Stop

The drive uses bit 0 in command data 0001H of the MEMOBUS register in the motor forward Run command (bit 0 = 1) and the stop command (bit 0 = 0). The drive uses bit 1 in the motor reverse Run command (bit 1 = 1) and the stop command (bit 1 = 0).

**1** : Run/Stop, FWD/REV

The drive uses bit 0 in command data 0001H of the MEMOBUS register in the motor Run command (bit 0 = 1) and the stop command (bit 0 = 0). The drive uses bit 1 in the direction of motor rotation command (Forward run (bit1 = 0) or Reverse run (bit 1 = 1)).

### ■ H5-17: ENTER command response @CPU BUSY

No. (Hex.)	Name	Description	Default (Range)
H5-17 (11A1) Expert	ENTER command response @CPU BUSY	<b>V/f</b> <b>CL-V/f</b> <b>OLV</b> <b>CLV</b> <b>AOLV</b> <b>OLV/PM</b> <b>AOLV/PM</b> <b>CLV/PM</b> <b>EZOLV</b> Sets operation when the EEPROM write command is sent without EEPROM write available. Usually it is not necessary to change this setting.	0 (0, 1)

**0** : Ignore Command(No ROM/RAM Write)

**1** : Write to RAM Only

### ■ H5-18: Motor Speed Filter over Comms

No. (Hex.)	Name	Description	Default (Range)
H5-18 (11A2)	Motor Speed Filter over Comms	<b>V/f</b> <b>CL-V/f</b> <b>OLV</b> <b>CLV</b> <b>AOLV</b> <b>OLV/PM</b> <b>AOLV/PM</b> <b>CLV/PM</b> <b>EZOLV</b> Sets the filter time constant used when monitoring motor speed during MEMOBUS/Modbus communications or with a communication option.	0 ms (0 - 100 ms)

Sets the filter time constant when you monitor the output frequency or motor speed during MEMOBUS/Modbus communications or use of the communication option.

These are the MEMOBUS registers:

- 003EH (Output Frequency)
- 003FH (Output Frequency)
- 0044H (U1-05: Motor Speed)
- 00ACH (U1-05: Motor Speed)
- 00ADH (U1-05: Motor Speed)

### ■ H5-20: Communication Parameters Reload

No. (Hex.)	Name	Description	Default (Range)
H5-20 (0B57)	Communication Parameters Reload	<b>V/f</b> <b>CL-V/f</b> <b>OLV</b> <b>CLV</b> <b>AOLV</b> <b>OLV/PM</b> <b>AOLV/PM</b> <b>CLV/PM</b> <b>EZOLV</b> Sets the function to immediately enable updated MEMOBUS/Modbus communications parameters.	0 (0, 1)

**0** : Reload at Next Power Cycle

**1** : Reload Now

**Note:**

- The setting value automatically returns to  $H5-20 = 0$  after you enable MEMOBUS/Modbus communications parameter changes.
- The setting values of these parameters are enabled:
  - H5-01 [Drive Node Address]
  - H5-02 [Communication Speed Selection]
  - H5-03 [Communication Parity Selection]
  - H5-06 [Drive Transmit Wait Time]

### ■ H5-25: Function 5A Register 1 Selection

No. (Hex.)	Name	Description	Default (Range)
H5-25 (1589) RUN	Function 5A Register 1 Selection	<b>V/f</b> <b>CL-V/f</b> <b>OLV</b> <b>CLV</b> <b>AOLV</b> <b>OLV/PM</b> <b>AOLV/PM</b> <b>CLV/PM</b> <b>EZOLV</b> Returns the contents of the specified MEMOBUS/Modbus communications register when responding to the master device.	0044H (U1-05) (0000H - FFFFH)

### ■ H5-26: Function 5A Register 2 Selection

No. (Hex.)	Name	Description	Default (Range)
H5-26 (158A) RUN	Function 5A Register 2 Selection	<b>V/f</b> <b>CL-V/f</b> <b>OLV</b> <b>CLV</b> <b>AOLV</b> <b>OLV/PM</b> <b>AOLV/PM</b> <b>CLV/PM</b> <b>EZOLV</b> Returns the contents of the specified MEMOBUS/Modbus communications register when responding to the master device.	0045H (U1-06) (0000H - FFFFH)

### ■ H5-27: Function 5A Register 3 Selection

No. (Hex.)	Name	Description	Default (Range)
H5-27 (158B) RUN	Function 5A Register 3 Selection	<b>V/f</b> <b>CL-V/f</b> <b>OLV</b> <b>CLV</b> <b>AOLV</b> <b>OLV/PM</b> <b>AOLV/PM</b> <b>CLV/PM</b> <b>EZOLV</b> Returns the contents of the specified MEMOBUS/Modbus communications register when responding to the master device.	0042H (U1-03) (0000H - FFFFH)

### ■ H5-28: Function 5A Register 4 Selection

No. (Hex.)	Name	Description	Default (Range)
H5-28 (158C) RUN	Function 5A Register 4 Selection	<b>V/f</b> <b>CL-V/f</b> <b>OLV</b> <b>CLV</b> <b>AOLV</b> <b>OLV/PM</b> <b>AOLV/PM</b> <b>CLV/PM</b> <b>EZOLV</b> Returns the contents of the specified MEMOBUS/Modbus communications register when responding to the master device.	0049H (U1-10) (0000H - FFFFH)

## ◆ H6: Pulse Train Input/Output

*H6 parameters* set the drive pulse train input and pulse train monitor. These parameters select input and monitor parameters and adjust the pulse train frequency.

A pulse train signal with a maximum single pulse of 32 kHz can be input to the drive input terminal RP. You can use the pulse train signal as the frequency reference, PID feedback value, PID setpoint value, and speed feedback for V/f Control mode.

A pulse train signal with a maximum frequency of 32 kHz can be output from the drive output terminal MP as the monitor value. Sinking mode and sourcing mode are supported.

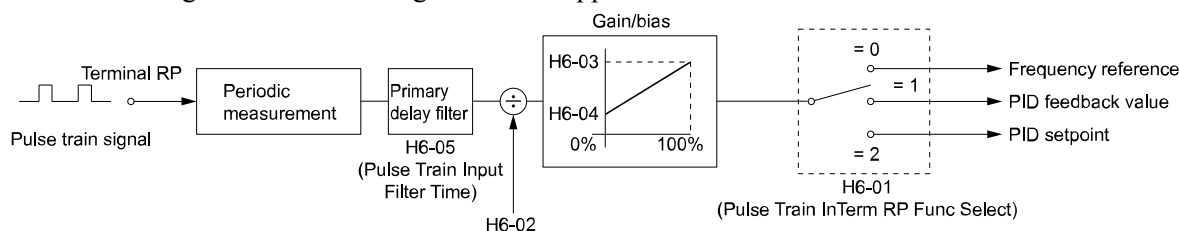


Figure 11.117 Pulse Train Input Block Diagram

### ■ H6-01: Terminal RP Pulse Train Function

No. (Hex.)	Name	Description	Default (Range)
H6-01 (042C)	Terminal RP Pulse Train Function	<b>V/f</b> <b>CL-V/f</b> <b>OLV</b> <b>CLV</b> <b>AOLV</b> <b>OLV/PM</b> <b>AOLV/PM</b> <b>CLV/PM</b> <b>EZOLV</b> Sets the function for pulse train input terminal RP.	0 (0 - 3)

#### 0 : Frequency Reference

When *b1-01 [Frequency Reference Selection 1]* or *b1-15 [Frequency Reference Selection 2]* = 4 [*Pulse Train Input*], the drive inputs the frequency reference received from terminal RP.

#### 1 : PID Feedback Value

The drive inputs the PID control feedback value received from terminal RP.

#### 2 : PID Setpoint Value

The drive inputs the PID control target value received from terminal RP.

#### 3 : Speed Feedback (V/F Control)

Select V/f Control method to enable simple encoder feedback.

Use motor speed feedback for better speed control precision. The drive compares the frequency reference to the motor speed feedback received from the encoder, and uses the ASR function to compensate for motor slip. You cannot use input terminal RP used for the simple encoder to detect the direction of motor rotation. Use a different method to detect motor rotation.

Use these methods to detect the direction of motor rotation.

- Use MFDI

Set MFDI H1-xx = 7E [Reverse Rotation Identifier]. When the configured terminal is activated, the motor operates in Reverse run. When the terminal is deactivated, the motor operates in Forward run. Use an encoder that outputs 2-tracks (phase A, B) to detect the direction of motor rotation.

- Use the frequency reference  
When you do not use the MFDI, the Forward/Reverse run command is the same as the direction of motor rotation.

Figure 11.118 shows speed control in Simple Closed Loop V/f Mode.

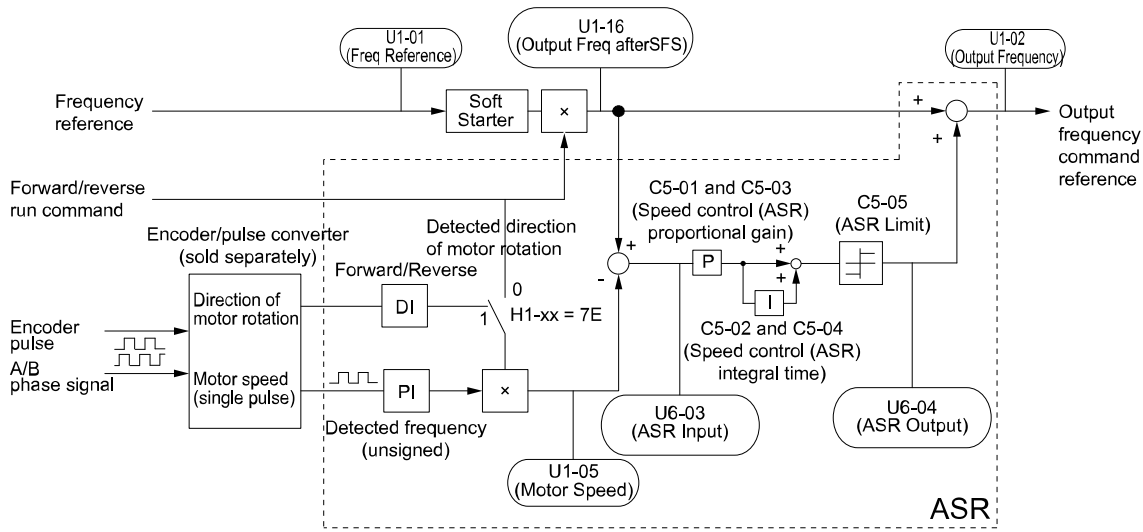


Figure 11.118 Simple Closed Loop Speed Control Block Diagram

**Enable Simple Closed Loop V/f Mode**

1. Connect the encoder output pulse wiring to terminal RP.
2. Set A1-02 = 0 [Control Method Selection = V/f Control].
3. Set H6-01 = 3.
4. Set H6-02 [Terminal RP Frequency Scaling] to the speed feedback (pulse train input signal) frequency at the time when the frequency reference is 100%.  
Make sure that H6-04 [Terminal RP Function Bias] = 0% and H6-03 [Terminal RP Function Gain] = 100%.
5. Select the detection method for the direction of motor rotation.  
When you use an MFDI, set H1-xx = 7E.
6. Set C5 parameters related to ASR gain and integral time to adjust responsiveness.

**Note:**

- Set A1-02 = 0 and H6-01 = 3 to show C5 parameters.
- You cannot use Closed Loop V/f Control mode with the Motor Switch function.

**■ H6-02: Terminal RP Frequency Scaling**

No. (Hex.)	Name	Description	Default (Range)
H6-02 (042D) RUN	Terminal RP Frequency Scaling	<div style="display: flex; justify-content: space-between; font-size: small;"> <span>V/f</span> <span>CL-V/f</span> <span>OLV</span> <span>CLV</span> <span>AOLV</span> <span>OLV/PM</span> <span>AOLV/PM</span> <span>CLV/PM</span> <span>EZOLV</span> </div> Sets the frequency of the pulse train input signal used when the function set with H6-01 [Terminal RP Pulse Train Function] is 100%.	1440 Hz (100 - 32000 Hz)

**■ H6-03: Terminal RP Function Gain**

No. (Hex.)	Name	Description	Default (Range)
H6-03 (042E) RUN	Terminal RP Function Gain	<div style="display: flex; justify-content: space-between; font-size: small;"> <span>V/f</span> <span>CL-V/f</span> <span>OLV</span> <span>CLV</span> <span>AOLV</span> <span>OLV/PM</span> <span>AOLV/PM</span> <span>CLV/PM</span> <span>EZOLV</span> </div> Sets the gain used when the function in H6-01 [Terminal RP Pulse Train Function] is input to terminal RP.	100.0% (0.0 - 1000.0%)

### ■ H6-04: Terminal RP Function Bias

No. (Hex.)	Name	Description	Default (Range)
H6-04 (042F) RUN	Terminal RP Function Bias	<b>V/f</b> <b>CL-V/f</b> <b>OLV</b> <b>CLV</b> <b>AOLV</b> <b>OLV/PM</b> <b>AOLV/PM</b> <b>CLV/PM</b> <b>EZOLV</b> Sets the bias used when the function in H6-01 [Terminal RP Pulse Train Function] is input to terminal RP. Sets a value when the pulse train is 0 Hz.	0.0% (-100.0 - 100.0%)

### ■ H6-05: Terminal RP Filter Time

No. (Hex.)	Name	Description	Default (Range)
H6-05 (0430) RUN	Terminal RP Filter Time	<b>V/f</b> <b>CL-V/f</b> <b>OLV</b> <b>CLV</b> <b>AOLV</b> <b>OLV/PM</b> <b>AOLV/PM</b> <b>CLV/PM</b> <b>EZOLV</b> Sets the time constant for the primary delay filters of the pulse train input.	0.10 s (0.00 - 2.00 s)

### ■ H6-06: Terminal MP Monitor Selection

No. (Hex.)	Name	Description	Default (Range)
H6-06 (0431) RUN	Terminal MP Monitor Selection	<b>V/f</b> <b>CL-V/f</b> <b>OLV</b> <b>CLV</b> <b>AOLV</b> <b>OLV/PM</b> <b>AOLV/PM</b> <b>CLV/PM</b> <b>EZOLV</b> Sets a function for pulse train monitor output terminal MP. Sets the "x-xx" part of the Ux-xx monitor.	102 (000, 031, 101, 102, 105, 116, 501, 502, 801 - 809, 821 - 825, 831 - 839, 851 - 855)

**Note:**

To use in through mode or when terminal MP is not used, set this parameter to 000 or 031.

When you use the pulse train monitor, make sure that you connect peripheral devices as specified by these load conditions:

Incorrect connections can make the characteristics not sufficient or cause mechanical damage.

- Use the pulse train monitor as the sourcing output.

Output Voltage VRL(V)	Load Impedance (kΩ)
5 V or more	1.5 kΩ or more
8 V or more	4.0 kΩ or more
10 V or more	10 kΩ or more

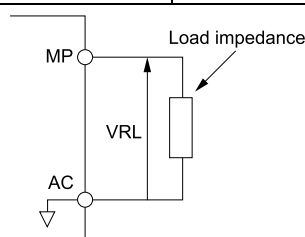


Figure 11.119 Circuit Diagram When Used as the Sourcing Output

- Use the pulse train monitor as the sinking input

External Power Supply (V)	12 VDC ± 10%, 15 VDC ± 10%
Sinking current (mA)	16 mA or less

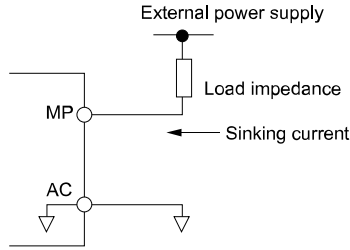


Figure 11.120 Circuit Diagram When Used as the Sinking Input

■ H6-07: Terminal MP Frequency Scaling

No. (Hex.)	Name	Description	Default (Range)
H6-07 (0432) RUN	Terminal MP Frequency Scaling	<span>V/f</span> <span>CL-V/f</span> <span>OLV</span> <span>CLV</span> <span>AOLV</span> <span>OLV/PM</span> <span>AOLV/PM</span> <span>CLV/PM</span> <span>EZOLV</span> Sets the frequency of the pulse train output signal used when the monitor set with H6-06 [Terminal MP Monitor Selection] is 100%.	1440 Hz (0 - 32000 Hz)

When H6-06 = 102 [Terminal MP Monitor Selection = Output Frequency] and H6-07 = 0, the pulse train output terminal MP outputs the same frequency as the drive output frequency.

■ H6-08: Terminal RP Minimum Frequency

No. (Hex.)	Name	Description	Default (Range)
H6-08 (043F)	Terminal RP Minimum Frequency	<span>V/f</span> <span>CL-V/f</span> <span>OLV</span> <span>CLV</span> <span>AOLV</span> <span>OLV/PM</span> <span>AOLV/PM</span> <span>CLV/PM</span> <span>EZOLV</span> Sets the minimum frequency of the pulse train signal that terminal RP can detect.	0.5 Hz (0.1 - 1000.0 Hz)

- When you input a pulse train frequency that is less than the value of H6-08, the pulse train input is 0.0 Hz.
- Set H6-01 [Terminal RP Pulse Train Function] = 0 [Frequency Reference], 1 [PID Feedback Value], or 2 [PID Setpoint Value] to enable this parameter.
- When H6-01 = 3 [Speed Feedback (V/F Control)], the drive applies the setting of F1-14 [Encoder Open-Circuit Detect Time] to the minimum frequency.

■ H6-09: Voltage Phase Sync MP Selection

No. (Hex.)	Name	Description	Default (Range)
H6-09 (156E)	Voltage Phase Sync MP Selection	<span>V/f</span> <span>CL-V/f</span> <span>OLV</span> <span>CLV</span> <span>AOLV</span> <span>OLV/PM</span> <span>AOLV/PM</span> <span>CLV/PM</span> <span>EZOLV</span> Set whether to output the pulse synchronized with drive output voltage phase from the pulse train monitor output terminal MP. This parameter is only enabled when H6-06 = 102 [Terminal MP Monitor Selection = Output Frequency] and H6-07 = 0 [Terminal MP Frequency Scaling = 0 Hz].	0 (0, 1)

0 : Disabled

1 : Enabled

◆ H7: Virtual Multi-Function I/O

The virtual I/O function performs the following.

- Inputs the result of the output from the MFDO terminal to the MFDI terminal without external wiring.
- Inputs the result of the output from the MFAO terminal to the MFAI terminal without external wiring.

**WARNING!** Sudden Movement Hazard. Make sure to confirm the setting values for virtual input and output function parameters before performing drive test runs. Virtual input and output functions may have different default settings and operation even though the input and output terminals are not wired as the drive input and output terminals are virtually wired internally. Failure to obey can cause death or serious injury.

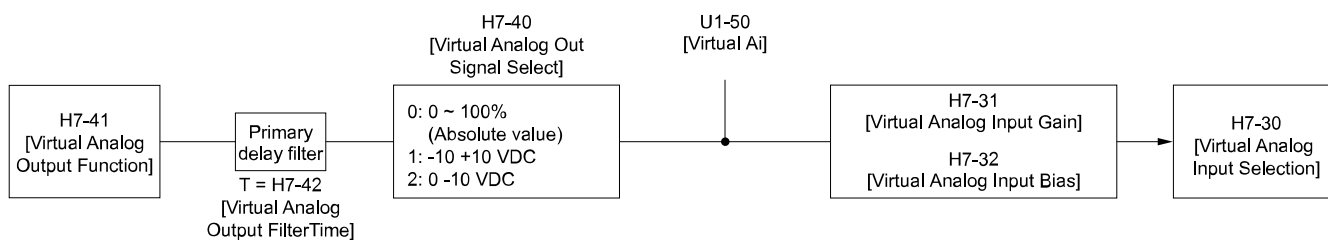


Figure 11.121 Virtual Analog I/O Functional Block Diagram

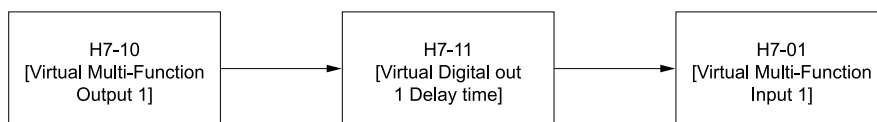


Figure 11.122 Virtual Digital I/O Functional Block Diagram

**Note:**

- Refer to H1-xx "MFDI Setting Values" for more information on the virtual digital input setting values.
- Refer to H2-xx "MFDO Setting Values" for more information on the virtual digital output setting values.
- Refer to H3-xx "MFAI Setting Values" for more information on the virtual analog input setting values.
- Refer to H4-xx "MFAO Setting Values" for more information on the virtual analog output setting values.
- 0 [3-Wire Sequence] and 20 to 2F [External Fault] cannot be selected in H7-01 to H7-04 [Virtual Multi-Function Input 1 to 4].
- If the terminal is not used, set H7-01 to H7-04 = F. However, the through mode function is not supported.
- The virtual I/O function selection and the multi-function input for DI-A3 cannot be used simultaneously.

■ **H7-00: Virtual MFIO selection**

No. (Hex.)	Name	Description	Default (Range)
H7-00 (116F) Expert	Virtual MFIO selection	<div style="display: flex; justify-content: space-between; font-size: small;"> <span>V/f</span> <span>CL-V/f</span> <span>OLV</span> <span>CLV</span> <span>AOLV</span> <span>OLV/PM</span> <span>AOLV/PM</span> <span>CLV/PM</span> <span>EZOLV</span> </div> <p>Sets the function to enable and disable the virtual I/O function. Set this parameter to 1 to operate the virtual I/O function.</p>	0 (0, 1)

**0 : Disabled**

**1 : Enabled**

■ **H7-01: Virtual Multi-Function Input 1**

No. (Hex.)	Name	Description	Default (Range)
H7-01 (1185) Expert	Virtual Multi-Function Input 1	<div style="display: flex; justify-content: space-between; font-size: small;"> <span>V/f</span> <span>CL-V/f</span> <span>OLV</span> <span>CLV</span> <span>AOLV</span> <span>OLV/PM</span> <span>AOLV/PM</span> <span>CLV/PM</span> <span>EZOLV</span> </div> <p>Sets the function that enters the virtual input set in H7-10 [Virtual Multi-Function Output 1].</p>	F (0 - 19F)

■ **H7-02: Virtual Multi-Function Input 2**

No. (Hex.)	Name	Description	Default (Range)
H7-02 (1186) Expert	Virtual Multi-Function Input 2	<div style="display: flex; justify-content: space-between; font-size: small;"> <span>V/f</span> <span>CL-V/f</span> <span>OLV</span> <span>CLV</span> <span>AOLV</span> <span>OLV/PM</span> <span>AOLV/PM</span> <span>CLV/PM</span> <span>EZOLV</span> </div> <p>Sets the function that enters the virtual input set in H7-12 [Virtual Multi-Function Output 2].</p>	F (0 - 19F)

■ **H7-03: Virtual Multi-Function Input 3**

No. (Hex.)	Name	Description	Default (Range)
H7-03 (1187) Expert	Virtual Multi-Function Input 3	<div style="display: flex; justify-content: space-between; font-size: small;"> <span>V/f</span> <span>CL-V/f</span> <span>OLV</span> <span>CLV</span> <span>AOLV</span> <span>OLV/PM</span> <span>AOLV/PM</span> <span>CLV/PM</span> <span>EZOLV</span> </div> <p>Sets the function that enters the virtual input set in H7-14 [Virtual Multi-Function Output 3].</p>	F (0 - 19F)

### ■ H7-04: Virtual Multi-Function Input 4

No. (Hex.)	Name	Description	Default (Range)
H7-04 (1188) Expert	Virtual Multi-Function Input 4	<div style="display: flex; justify-content: space-between; font-size: 0.8em; font-weight: bold; margin-bottom: 5px;"> <span>V/f</span> <span>CL-V/f</span> <span>OLV</span> <span>CLV</span> <span>AOLV</span> <span>OLV/PM</span> <span>AOLV/PM</span> <span>CLV/PM</span> <span>EZOLV</span> </div> Sets the function that enters the virtual input set in H7-16 [Virtual Multi-Function Output 4].	F (0 - 19F)

### ■ H7-10: Virtual Multi-Function Output 1

No. (Hex.)	Name	Description	Default (Range)
H7-10 (11A4) Expert	Virtual Multi-Function Output 1	<div style="display: flex; justify-content: space-between; font-size: 0.8em; font-weight: bold; margin-bottom: 5px;"> <span>V/f</span> <span>CL-V/f</span> <span>OLV</span> <span>CLV</span> <span>AOLV</span> <span>OLV/PM</span> <span>AOLV/PM</span> <span>CLV/PM</span> <span>EZOLV</span> </div> Sets the function for virtual digital output 1.	F (0 - 1A7)

### ■ H7-11: Virtual Output 1 Delay Time

No. (Hex.)	Name	Description	Default (Range)
H7-11 (11A5) Expert	Virtual Output 1 Delay Time	<div style="display: flex; justify-content: space-between; font-size: 0.8em; font-weight: bold; margin-bottom: 5px;"> <span>V/f</span> <span>CL-V/f</span> <span>OLV</span> <span>CLV</span> <span>AOLV</span> <span>OLV/PM</span> <span>AOLV/PM</span> <span>CLV/PM</span> <span>EZOLV</span> </div> Sets the minimum ON time for virtual digital output 1.	0.1 s (0.0 - 25.0 s)

### ■ H7-12: Virtual Multi-Function Output 2

No. (Hex.)	Name	Description	Default (Range)
H7-12 (11A6) Expert	Virtual Multi-Function Output 2	<div style="display: flex; justify-content: space-between; font-size: 0.8em; font-weight: bold; margin-bottom: 5px;"> <span>V/f</span> <span>CL-V/f</span> <span>OLV</span> <span>CLV</span> <span>AOLV</span> <span>OLV/PM</span> <span>AOLV/PM</span> <span>CLV/PM</span> <span>EZOLV</span> </div> Sets the function for virtual digital output 2.	F (0 - 1A7)

### ■ H7-13: Virtual Output 2 Delay Time

No. (Hex.)	Name	Description	Default (Range)
H7-13 (11A7) Expert	Virtual Output 2 Delay Time	<div style="display: flex; justify-content: space-between; font-size: 0.8em; font-weight: bold; margin-bottom: 5px;"> <span>V/f</span> <span>CL-V/f</span> <span>OLV</span> <span>CLV</span> <span>AOLV</span> <span>OLV/PM</span> <span>AOLV/PM</span> <span>CLV/PM</span> <span>EZOLV</span> </div> Sets the minimum ON time for virtual digital output 2.	0.1 s (0.0 - 25.0 s)

### ■ H7-14: Virtual Multi-Function Output 3

No. (Hex.)	Name	Description	Default (Range)
H7-14 (11A8) Expert	Virtual Multi-Function Output 3	<div style="display: flex; justify-content: space-between; font-size: 0.8em; font-weight: bold; margin-bottom: 5px;"> <span>V/f</span> <span>CL-V/f</span> <span>OLV</span> <span>CLV</span> <span>AOLV</span> <span>OLV/PM</span> <span>AOLV/PM</span> <span>CLV/PM</span> <span>EZOLV</span> </div> Sets the function for virtual digital output 3.	F (0 - 1A7)

### ■ H7-15: Virtual Output 3 Delay Time

No. (Hex.)	Name	Description	Default (Range)
H7-15 (11A9) Expert	Virtual Output 3 Delay Time	<div style="display: flex; justify-content: space-between; font-size: 0.8em; font-weight: bold; margin-bottom: 5px;"> <span>V/f</span> <span>CL-V/f</span> <span>OLV</span> <span>CLV</span> <span>AOLV</span> <span>OLV/PM</span> <span>AOLV/PM</span> <span>CLV/PM</span> <span>EZOLV</span> </div> Sets the minimum ON time for virtual digital output 3.	0.1 s (0.0 - 25.0 s)



### ■ H7-16: Virtual Multi-Function Output 4

No. (Hex.)	Name	Description	Default (Range)
H7-16 (11AA) Expert	Virtual Multi-Function Output 4	<b>V/f</b> <b>CL-V/f</b> <b>OLV</b> <b>CLV</b> <b>AOLV</b> <b>OLV/PM</b> <b>AOLV/PM</b> <b>CLV/PM</b> <b>EZOLV</b> Sets the function for virtual digital output 4.	F (0 - 1A7)

### ■ H7-17: Virtual Output 4 Delay Time

No. (Hex.)	Name	Description	Default (Range)
H7-17 (11AB) Expert	Virtual Output 4 Delay Time	<b>V/f</b> <b>CL-V/f</b> <b>OLV</b> <b>CLV</b> <b>AOLV</b> <b>OLV/PM</b> <b>AOLV/PM</b> <b>CLV/PM</b> <b>EZOLV</b> Sets the minimum ON time for virtual digital output 4.	0.1 s (0.0 - 25.0 s)

### ■ H7-30: Virtual Analog Input Selection

No. (Hex.)	Name	Description	Default (Range)
H7-30 (1177)	Virtual Analog Input Selection	<b>V/f</b> <b>CL-V/f</b> <b>OLV</b> <b>CLV</b> <b>AOLV</b> <b>OLV/PM</b> <b>AOLV/PM</b> <b>CLV/PM</b> <b>EZOLV</b> Sets the virtual analog input function.	F (0 - 32)

### ■ H7-31: Virtual Analog Input Gain

No. (Hex.)	Name	Description	Default (Range)
H7-31 (1178) RUN Expert	Virtual Analog Input Gain	<b>V/f</b> <b>CL-V/f</b> <b>OLV</b> <b>CLV</b> <b>AOLV</b> <b>OLV/PM</b> <b>AOLV/PM</b> <b>CLV/PM</b> <b>EZOLV</b> Sets the virtual analog input gain.	100.0% (-999.9 - 999.9%)

### ■ H7-32: Virtual Analog Input Bias

No. (Hex.)	Name	Description	Default (Range)
H7-32 (1179) RUN Expert	Virtual Analog Input Bias	<b>V/f</b> <b>CL-V/f</b> <b>OLV</b> <b>CLV</b> <b>AOLV</b> <b>OLV/PM</b> <b>AOLV/PM</b> <b>CLV/PM</b> <b>EZOLV</b> Sets the virtual analog input bias.	0.0% (-999.9 - 999.9%)

### ■ H7-40: Virtual Analog Out Signal Select

No. (Hex.)	Name	Description	Default (Range)
H7-40 (1163)	Virtual Analog Out Signal Select	<b>V/f</b> <b>CL-V/f</b> <b>OLV</b> <b>CLV</b> <b>AOLV</b> <b>OLV/PM</b> <b>AOLV/PM</b> <b>CLV/PM</b> <b>EZOLV</b> Sets the signal level of the virtual analog output.	0 (0 - 2)

**0** : 0 to 100% (Absolute Value)

**1** : -100 to 100%

**2** : 0 to 100% (Lower Limit at 0)

### ■ H7-41: Virtual Analog Output Function

No. (Hex.)	Name	Description	Default (Range)
H7-41 (1164)	Virtual Analog Output Function	<b>V/f</b> <b>CL-V/f</b> <b>OLV</b> <b>CLV</b> <b>AOLV</b> <b>OLV/PM</b> <b>AOLV/PM</b> <b>CLV/PM</b> <b>EZOLV</b> Sets the monitor to be output from the virtual analog output. Set the <i>x-xx</i> part of the <i>Ux-xx [Monitor]</i> . For example, set <i>x-xx</i> to <i>102</i> to monitor <i>U1-02 [Output Frequency]</i> .	102 (0 - 999)

## ■ H7-42: Virtual Analog Output FilterTime

No. (Hex.)	Name	Description	Default (Range)
H7-42 (1165)	Virtual Analog Output FilterTime	<b>Vf</b> <b>CL-Vf</b> <b>OLV</b> <b>CLV</b> <b>AOLV</b> <b>OLV/PM</b> <b>AOLV/PM</b> <b>CLV/PM</b> <b>EZOLV</b> Sets the time constant for a primary filter of the virtual analog output.	0.00 s (0.00 - 2.00 s)

## 11.9 L: Protection Functions

*L* parameters set the following functions.

- Motor Overload Protection
- Operation During Momentary Power Loss
- Stall Prevention
- Speed Detection
- Auto Restart
- Detection of Overtorque/Undertorque
- Torque Limit
- Hardware Protection

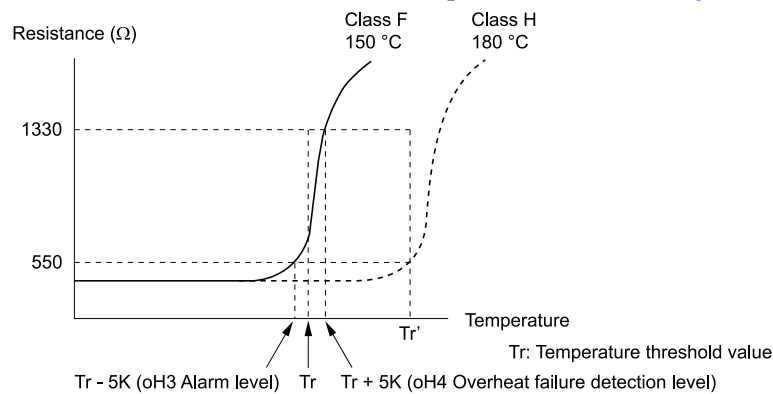
### ◆ L1: Motor Protection

*L1* parameters set the motor overload protection function.

#### ■ Motor Protection Using Positive Temperature Coefficient (PTC) Thermistors

The temperature resistance characteristics of three PTC thermistors in the motor stator winding protect the motor from overheat.

The PTC thermistors must have the characteristics in motor 1 phase as shown in [Figure 11.123](#).



**Figure 11.123 PTC Thermistor Temperature and Resistance**

When the PTC input signal input to the drive is more than the overload alarm level, the drive detects *oH3* [*Motor Overheat (PTC Input)*] and flashes it on the keypad. The drive continues the operation set in *L1-03* [*Motor Thermistor oH Alarm Select*].

The overheat fault level triggers an *oH4* [*Motor Overheat Fault (PTC Input)*] fault, and outputs a fault signal. The drive outputs a fault signal, and stops the motor with the stop method set in *L1-04* [*Motor Thermistor oH Fault Select*].

**Note:**

PTC is an acronym for Positive Temperature Coefficient.

[Figure 11.124](#) shows the configuration procedure when you use terminal A3.

1. Connect the PTC thermistor input from the motor to analog input terminal A3 on the drive.

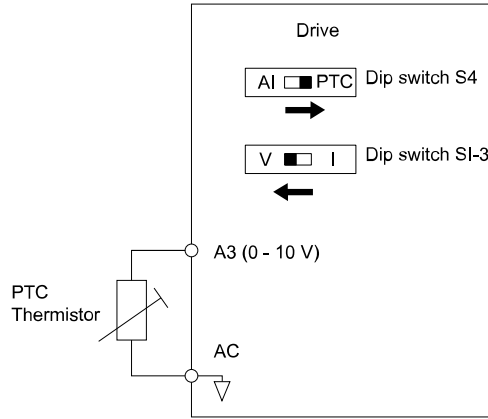


Figure 11.124 Connect Motor PTC

2. Set drive DIP switch S1-3 to V (voltage) and set DIP switch S4 to PTC.
3. Set these MFAI terminals:
  - Set H3-05 = 0 [Terminal A3 Signal Level Select = 0 to 10V (Lower Limit at 0)].
  - Set H3-06 = E [Terminal A3 Function Selection = Motor Temperature (PTC Input)].
4. Set these L1 parameters:
  - L1-03 [Motor Thermistor oH Alarm Select]
  - L1-04 [Motor Thermistor oH Fault Select]
  - L1-05 [Motor Thermistor Filter Time]

■ L1-01: Motor Overload (oL1) Protection

No. (Hex.)	Name	Description	Default (Range)
L1-01 (0480)	Motor Overload (oL1) Protection	<span style="background-color: black; color: white; padding: 2px;">V/f</span> <span style="background-color: black; color: white; padding: 2px;">CL-V/f</span> <span style="background-color: black; color: white; padding: 2px;">OLV</span> <span style="background-color: black; color: white; padding: 2px;">CLV</span> <span style="background-color: black; color: white; padding: 2px;">AOLV</span> <span style="background-color: black; color: white; padding: 2px;">OLV/PM</span> <span style="background-color: black; color: white; padding: 2px;">AOLV/PM</span> <span style="background-color: black; color: white; padding: 2px;">CLV/PM</span> <span style="background-color: black; color: white; padding: 2px;">EZOLV</span> Sets the motor overload protection with electronic thermal protectors.	Determined by A1-02 (0 - 6)

This parameter enables and disables the motor overload protection with electronic thermal protectors. The cooling capability of the motor changes when the speed control range of the motor changes. Use an electronic thermal protector that aligns with the permitted load characteristics of the motor to select motor protection. The electronic thermal protector of the drive uses these items to calculate motor overload tolerance and supply overload protection for the motor:

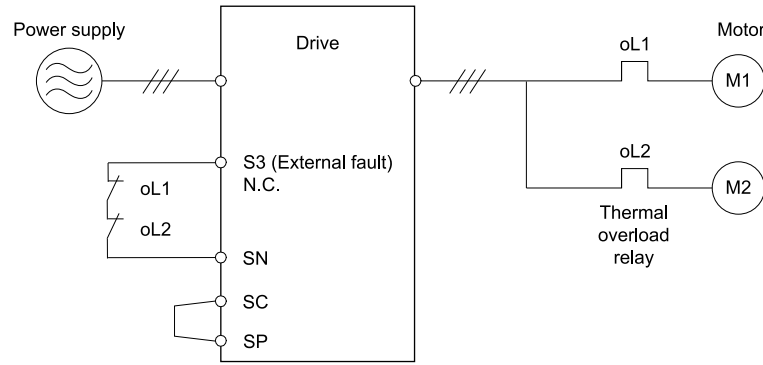
- Output current
- Output frequency
- Motor thermal characteristics
- Time characteristics

If the drive detects motor overload, the drive will trigger an oL1 [Motor Overload] and stop the drive output. Set H2-01 = 1F [Term M1-M2 Function Selection = Motor Overload Alarm (oL1)] to set a motor overload alarm. If the motor overload level is more than 90% of the oL1 detection level, the output terminal turns ON and triggers an overload alarm.

**0 : Disabled**

Disable motor protection when motor overload protection is not necessary or when the drive is operating more than one motor.

Refer to Figure 11.125 for an example of the circuit configuration to connect more than one motor to one drive.



**Figure 11.125 Protection Circuit Configuration to Connect More than One Motor to One Drive**

**NOTICE:** When one drive is operating more than one motor at the same time or when the rated current of the motor is much larger than rated current of a standard motor, you cannot protect the motor with electronic thermal protection. To protect each motor, set L1-01 = 0 [Motor Overload (oL1) Protection = Disabled], configure the circuits, then add thermal relays to each motor. The magnetic contactor installed for motor protection cannot be switched ON/OFF during run. Failure to obey can cause motor failure.

**1 : Variable Torque**

Use this setting for general-purpose motors with a 60 Hz base frequency.

The overload tolerance decreases as motor speed decreases because the cooling fan speed decreases and the ability of the motor to cool decreases in the low speed range.

The overload tolerance characteristics of the motor change the trigger point for the electronic thermal protector. This provides motor overload protection from low speed to high speed across the full speed range.

Load Tolerance	Cooling Capability	Overload Characteristics (at 100% motor load)
	<p>This motor is designed to operate with commercial line power. Operate at a 60 Hz base frequency to maximize the motor cooling ability.</p>	<p>If the motor operates at frequencies less than 60 Hz, the drive will detect oL1. The drive triggers a fault relay output and the motor coasts to stop.</p>

**2 : Constant Torque 10:1 Speed Range**

Use this setting for drive-dedicated motors with a speed range for constant torque of 1:10.

The speed control for this motor is 10% to 100% when at 100% load. Operating slower than 10% speed at 100% load will cause motor overload.

Load Tolerance	Cooling Capability	Overload Characteristics (at 100% motor load)
	<p>This motor is designed to withstand increased temperatures during continuous operation in the low speed range (10% base frequency).</p>	<p>The motor operates continuously at 10% to 100% base frequency. Operating slower than 10% speed at 100% load will cause motor overload.</p>

**3 : Constant Torque 100:1 Speed Range**

## 11.9 L: Protection Functions

Use this setting for vector motors with a speed range for constant torque of 1:100.

The speed control for this motor is 1% to 100% when at 100% load. Operating slower than 1% speed at 100% load will cause motor overload.

Load Tolerance	Cooling Capability	Overload Characteristics (at 100% motor load)
	<p>This motor is designed to withstand increased temperatures during continuous operation in the low speed range (1% base frequency).</p>	<p>The motor operates continuously at 1% to 100% base frequency. Operating slower than 1% speed at 100% load will cause motor overload.</p>

### 4 : PM Variable Torque

Use this setting for PM motors with derated torque characteristics.

The overload tolerance decreases as motor speed decreases because the cooling fan speed decreases and the ability of the motor to cool decreases in the low speed range.

The overload tolerance characteristics of the motor change the trigger point for the electronic thermal protector. This provides motor overheat protection from low speed to high speed across the full speed range.

Load Tolerance	Cooling Capability	Overload Characteristics (at 100% motor load)
	<p>This motor is designed to withstand increased temperatures during continuous operation at rated speed and rated torque.</p>	<p>If the motor operates continuously at lower speed than rated rotation speed at more than 100% torque, the drive will detect <i>oLL</i>. The drive triggers a fault relay output and the motor coasts to stop.</p>

### 5 : PM Constant Torque

Use this setting with a PM motor for constant torque that has a speed range for constant torque of 1:500.

The speed control for this motor is 0.2% to 100% when at 100% load. Operating slower than 0.2% speed at 100% load will cause motor overload.

Load Tolerance	Cooling Capability	Overload Characteristics (at 100% motor load)
	<p>This motor is designed to withstand increased temperatures during continuous operation in the low speed range (0.2% base frequency).</p>	<p>The motor operates continuously at 0.2% to 100% rated speed. Operating slower than 0.2% speed at 100% load will cause motor overload.</p>

### 6 : Variable Torque (50Hz)

Use this setting for general-purpose motors with a base frequency of 50 Hz.

The overload tolerance decreases as motor speed decreases because the cooling fan speed decreases and the ability of the motor to cool decreases in the low speed range.

The overload tolerance characteristics of the motor change the trigger point for the electronic thermal protector. This provides motor overload protection from low speed to high speed across the full speed range.

Load Tolerance	Cooling Capability	Overload Characteristics (at 100% motor load)
	<p>This motor is designed to operate with commercial line power. Operate at a 50 Hz base frequency to maximize the motor cooling ability.</p>	<p>If the motor operates at frequencies less than commercial line power, the drive will detect <i>oLI</i>. The drive triggers a fault relay output and the motor coasts to stop.</p>

**L1-02: Motor Overload Protection Time**

No. (Hex.)	Name	Description	Default (Range)
L1-02 (0481)	Motor Overload Protection Time	<p><b>V/f CL-V/f OLV CLV AOLV OLV/PM AOLV/PM CLV/PM EZOLV</b></p> <p>Sets the operation time for the electronic thermal protector of the drive to prevent damage to the motor. Usually it is not necessary to change this setting.</p>	1.0 min (0.1 - 5.0 min)

Set the overload tolerance time to the length of time that the motor can operate at 150% load from continuous operation at 100% load.

When the motor operates at 150% load continuously for 1 minute after continuous operation at 100% load (hot start), the default setting triggers the electronic thermal protector.

Figure 11.126 shows an example of the electronic thermal protector operation time. Motor overload protection operates in the range between a cold start and a hot start.

This example shows a general-purpose motor operating at the base frequency with *L1-02* set to 1.0 min.

- Cold start  
Shows the motor protection operation time characteristics when the overload occurs immediately after starting operation from a complete stop.
- Hot start  
Shows the motor protection operation time characteristics when overload occurs from continuous operation below the motor rated current.

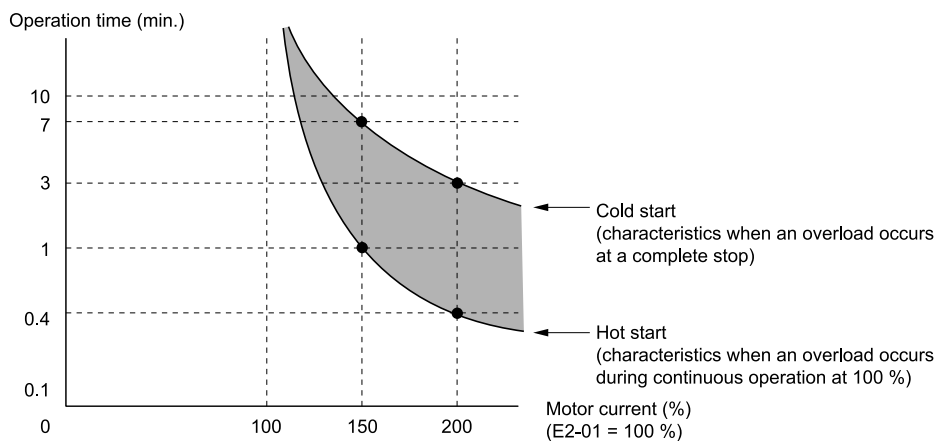


Figure 11.126 Protection Operation Time for a General-purpose Motor at Rated Output Frequency

**L1-03: Motor Thermistor oH Alarm Select**

No. (Hex.)	Name	Description	Default (Range)
L1-03 (0482)	Motor Thermistor oH Alarm Select	<p><b>V/f CL-V/f OLV CLV AOLV OLV/PM AOLV/PM CLV/PM EZOLV</b></p> <p>Sets drive operation when the PTC input signal entered into the drive is at the <i>oH3</i> [Motor Overheat Alarm] detection level.</p>	3 (0 - 3)

**0 : Ramp to Stop**

The drive ramps the motor to stop in the deceleration time. Fault relay output terminal MA-MC turns ON and MB-MC turns OFF.

**1 : Coast to Stop**

The output turns OFF and the motor coasts to stop. Fault relay output terminal MA-MC turns ON, and MB-MC turns OFF.

**2 : Fast Stop (Use C1-09)**

The drive stops the motor in the deceleration time set in *C1-09 [Fast Stop Time]*. Fault relay output terminal MA-MC turns ON, and MB-MC turns OFF.

**3 : Alarm Only**

The keypad shows *oH3*, and operation continues. The output terminal set for *Alarm [H2-01 to H2-03 = 10]* turns ON.

■ **L1-04: Motor Thermistor oH Fault Select**

No. (Hex.)	Name	Description	Default (Range)
L1-04 (0483)	Motor Thermistor oH Fault Select	<b>V/f</b> <b>CL-V/f</b> <b>OLV</b> <b>CLV</b> <b>AOLV</b> <b>OLV/PM</b> <b>AOLV/PM</b> <b>CLV/PM</b> <b>EZOLV</b> Sets the drive operation when the PTC input signal to the drive is at the <i>oH4 [Motor Overheat Fault (PTC Input)]</i> detection level.	1 (0 - 2)

**0 : Ramp to Stop**

The drive ramps the motor to stop in the deceleration time. Fault relay output terminal MA-MC turns ON and MB-MC turns OFF.

**1 : Coast to Stop**

The output turns OFF and the motor coasts to stop. Fault relay output terminal MA-MC turns ON, and MB-MC turns OFF.

**2 : Fast Stop (Use C1-09)**

The drive stops the motor in the deceleration time set in *C1-09 [Fast Stop Time]*. Fault relay output terminal MA-MC turns ON, and MB-MC turns OFF.

■ **L1-05: Motor Thermistor Filter Time**

No. (Hex.)	Name	Description	Default (Range)
L1-05 (0484)	Motor Thermistor Filter Time	<b>V/f</b> <b>CL-V/f</b> <b>OLV</b> <b>CLV</b> <b>AOLV</b> <b>OLV/PM</b> <b>AOLV/PM</b> <b>CLV/PM</b> <b>EZOLV</b> Sets the primary delay time constant for the PTC input signal entered to the drive. This parameter prevents accidental motor overheat faults.	0.20 s (0.00 - 10.00 s)

■ **L1-08: oL1 Current Level**

No. (Hex.)	Name	Description	Default (Range)
L1-08 (1103)	oL1 Current Level	<b>V/f</b> <b>CL-V/f</b> <b>OLV</b> <b>CLV</b> <b>AOLV</b> <b>OLV/PM</b> <b>AOLV/PM</b> <b>CLV/PM</b> <b>EZOLV</b> Sets the reference current for the motor 1 thermal overload detection.	0.0 A (0.0 A or 10% to 150% of the drive rated current)

When *L1-08 = 0.0 A*, the drive uses *E2-01 [Motor Rated Current (FLA)]* to detect the motor overload protection. In PM control mode, the drive uses *E5-03 [PM Motor Rated Current (FLA)]* to detect the motor overload protection.

When *L1-08 ≠ 0.0 A*, the set value is the reference for motor overload protection.

**Note:**

- Display is in these units:  
–Models 2004 to 2042, 4002 to 4023: 0.01 A  
–Models 2056 to 2415, 4031 to 4675: 0.1 A
- When the current level > 0.0 A, you cannot set this value < 10% of drive rated current.



### ■ L1-09: oL1 Current Level for Motor 2

No. (Hex.)	Name	Description	Default (Range)
L1-09 (1104)	oL1 Current Level for Motor 2	<b>V/f</b> <b>CL-V/f</b> <b>OLV</b> <b>CLV</b> <b>AOLV</b> <b>OLV/PM</b> <b>AOLV/PM</b> <b>CLV/PM</b> <b>EZOLV</b> Sets the reference current for the motor 2 thermal overload detection.	0.0 A (0.0 A or 10 to 150% of the drive rated current)

When  $L1-09 = 0.0 A$ , the drive uses  $E4-01$  [Motor 2 Rated Current] to detect the motor overload protection.

When  $L1-09 \neq 0.0 A$ , the set value is the reference for motor overload protection.

**Note:**

- Display is in these units:
  - Models 2004 to 2042, 4002 to 4023: 0.01 A
  - Models 2056 to 2415, 4031 to 4675: 0.1 A
- When the current level  $> 0.0 A$ , you cannot set this value  $< 10\%$  of drive rated current.

### ■ L1-13: Motor Overload Memory Selection

No. (Hex.)	Name	Description	Default (Range)
L1-13 (046D)	Motor Overload Memory Selection	<b>V/f</b> <b>CL-V/f</b> <b>OLV</b> <b>CLV</b> <b>AOLV</b> <b>OLV/PM</b> <b>AOLV/PM</b> <b>CLV/PM</b> <b>EZOLV</b> Sets the function that keeps the current electronic thermal protector value when the drive stops receiving power.	1 (0, 1)

**0 : Disabled**

**1 : Enabled**

Sets if the drive will calculate the motor again when the drive is energized again.

## ◆ L2: Power Loss Ride Through

$L2$  parameters set the drive operation during momentary power loss and the KEB Ride-Thru function method of operation.

### ■ KEB Ride-Thru Function

KEB is an acronym for Kinetic Energy Backup. If the drive detects a power loss or momentary power loss, it will quickly decelerate the motor. The drive uses regenerative energy from the motor to keep the main circuit operating. When you return power during motor deceleration, the drive returns operation to the status before the power loss.

The KEB Ride-Thru function is different than other functions for continuous operation. If the drive detects momentary power loss, the motor will ramp to stop. It will not coast to stop. This function is applicable for applications in which it is necessary to prevent materials from running out, for example control for film and fiber lines. The KEB Ride-Thru function has 4 methods of operation. Parameter  $L2-29$  [Kinetic Energy Backup Method] sets the method.

When you use the KEB Ride-Thru function with one drive, set  $L2-29 = 0, 1$  [Single Drive KEB Ride-Thru 1, Single Drive KEB Ride-Thru 2].

If deceleration in coordination with more than one drive is necessary, for example textile machinery line systems, set  $L2-29 = 2, 3$  [System KEB Ride-Thru 1, System KEB Ride-Thru 2].

Table 11.70 KEB Ride-Thru Function Operation Method

L2-29	Kinetic Energy Backup Method	Operation	Configuration Precautions
0	Single Drive KEB Ride-Thru 1	The drive uses regenerative energy from the motor to keep the DC bus voltage at the level set in L2-11 [KEB DC Bus Voltage Setpoint] while it adjusts the rate of deceleration. The KEB operation continues while the drive adjusts the deceleration rate with the setting of C1-09 [Fast Stop Time].	<ul style="list-style-type: none"> <li>Set C1-09 correctly to prevent Uv1 [DC Bus Undervoltage] and ov [Overvoltage].</li> <li>If the drive detects Uv1 during the KEB operation, decrease the value set in C1-09.</li> <li>If the drive detects ov during the KEB operation, increase the value set in C1-09.</li> </ul>
1	Single Drive KEB Ride-Thru 2	The drive uses information about the inertia of the connected machinery to find the deceleration rate necessary to keep the DC bus voltage at the level set in parameter L2-11. The drive uses system inertia to calculate the deceleration time. You cannot adjust this value.	<ul style="list-style-type: none"> <li>If the drive detects Uv1 during the KEB operation, increase the setting value of L3-20 [DC Bus Voltage Adjustment Gain] and L3-21 [OV Suppression Accel/Decel P Gain].</li> <li>If the drive detects ov during the KEB operation, decrease the setting value of L3-20 and L3-21.</li> </ul>
2	System KEB Ride-Thru 1	The drive does not monitor the DC bus voltage. The drive decelerates at the KEB deceleration time set in L2-06. Use L2-06 to set the time necessary to decelerate from the current frequency reference to 0 Hz. More than one drive can decelerate and keep a constant speed ratio between drives.	Use the dynamic braking option with System KEB Ride-Thru 1.
3	System KEB Ride-Thru 2	The drive uses the KEB deceleration time set in L2-06 to decelerate and it also monitors the DC bus voltage. If the voltage level increases, the drive momentarily holds the frequency to prevent an ov before it continues to decelerate.	If you cannot use the dynamic braking option, use System KEB Ride-Thru 2.

### ■ KEB Ride Thru Start

When L2-01 = 3, 4, 5 [Power Loss Ride Through Select = Kinetic Energy Backup: L2-02, Kinetic Energy Backup: CPU Power; Kinetic Energy Backup: DecelStop], the drive starts the KEB operation immediately after it detects a momentary power loss. When one of these conditions occur, the drive will activate KEB Ride-Thru:

- KEB Ride-Thru 1 set for the MFDI terminal becomes enabled (terminal is deactivated when H1-xx = 65 or terminal is activated when H1-xx = 66).  
The drive uses the mode selected L2-29 [Kinetic Energy Backup Method] to start KEB operation.
- KEB Ride-Thru 2 set for the MFDI terminal becomes enabled (terminal is deactivated when H1-xx = 7A or terminal is activated when H1-xx = 7B).  
The drive automatically starts Single KEB Ride-Thru 2 and it ignores the setting of L2-29.
- The DC bus voltage is less than the level set in L2-05 [Undervoltage Detection Lvl (Uv1)].  
The KEB operation will start as specified in L2-29.

#### Note:

If you try to set KEB Ride-Thru 1 and 2 to the MFDI terminals at the same time, it will trigger oPE03 [Multi-Function Input Setting Err].

In this example, the drive detects that the DC bus voltage is less than the level set in L2-05 and starts the KEB operation. When you return power during KEB operation, the drive will continue KEB operation when the KEB Ride-Thru is input, although the time set in L2-10 [Minimum KEB Time] expired. The motor accelerates again after you cancel the KEB Ride-Thru.

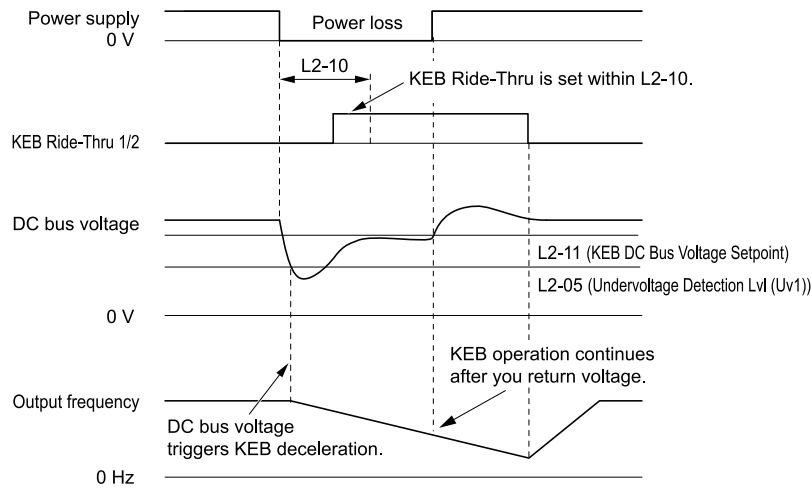


Figure 11.127 KEB Operation through KEB Ride-Thru Input

### ■ KEB Ride-Thru End Detection

Parameter *L2-01* and a digital input programmed for KEB set the KEB function end detection.

#### Use the Momentary Power Loss Ride-Thru Time to Cancel KEB Operation

Figure 11.128 shows an example that uses this configuration:

- *L2-01* = 3 [*Power Loss Ride Through Select* = *Kinetic Energy Backup: L2-02*].
- KEB Ride-Thru is not used.

The drive starts deceleration through KEB operation. The drive stops the KEB operation. When the time set in *L2-10* [*Minimum KEB Time*] expires, the drive stops the KEB operation and then it accelerates the motor again until it is at the frequency reference value used before the power loss.

If you do not return the DC bus voltage in the time set in *L2-02* [*Power Loss Ride Through Time*], the drive detects *Uv1* [*DC Bus Undervoltage*] and the drive turns off its output.

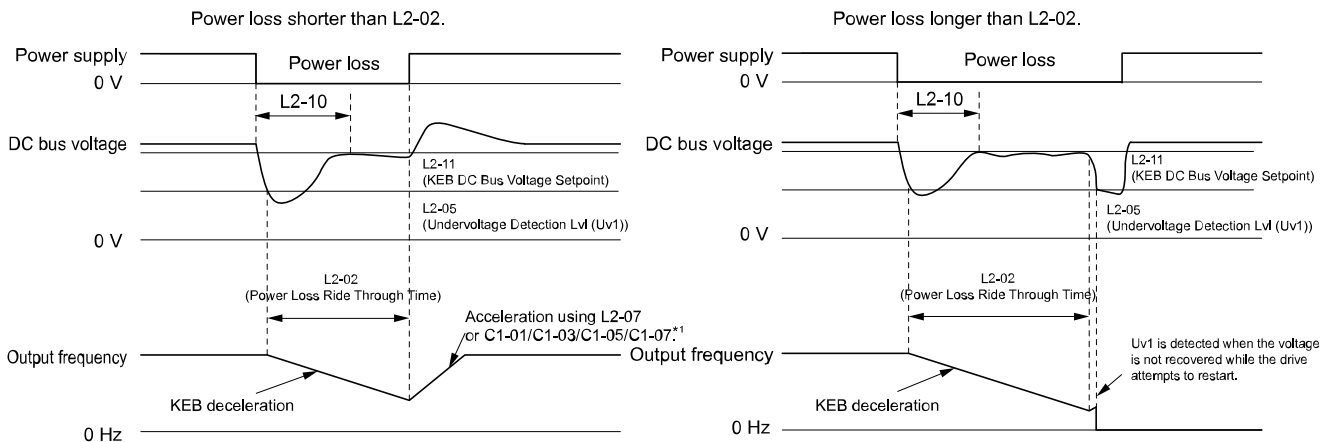


Figure 11.128 Cancel the KEB Operation after the Momentary Power Loss Ride-Thru Time Is Expired without KEB Ride-Thru

\*1 When *L2-07* = 0.00 [*Kinetic Energy Backup Accel Time* = 0.00 s], the drive accelerates again as specified by the applicable *Acceleration Time* [*C1-01, C1-03, C1-05, C1-07*], and usual operation continues.

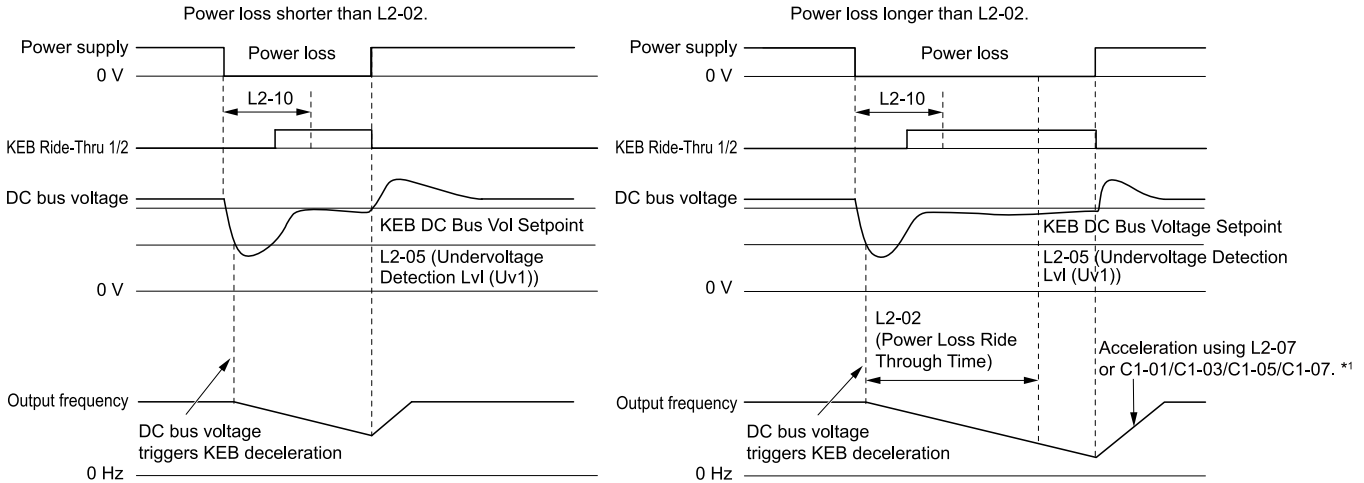
#### Use the Momentary Power Loss Ride-Thru Time and KEB Ride-Thru to Cancel KEB Operation

Figure 11.129 shows an example that uses this configuration:

- *L2-01* = 3.
- Use *KEB Ride-Thru 1* [*H1-xx* = 65, 66] or *KEB Ride-Thru 2* [*H1-xx* = 7A, 7B].

The drive starts deceleration through KEB operation. The drive decelerates for the time set in parameter *L2-10*, then it measures the DC bus voltage and the status of the digital input terminal set for KEB Ride-Thru. When the DC bus voltage is less than the level set in *L2-11* [*KEB DC Bus Voltage Setpoint*] or if the KEB digital input is active, KEB deceleration continues. If the voltage level is more than the level set in *L2-11*, it continues usual operation. The drive accelerates the motor to the frequency reference value used before the power loss, and usual

operation continues. If the time set in *L2-02* is expired, the drive detects *Uv1*. When you cancel the KEB Ride-Thru, the motor accelerates again, and usual operation continues.



**Figure 11.129 Use the Momentary Power Loss Ride-Thru Time and KEB Ride-Thru to Cancel KEB Operation**

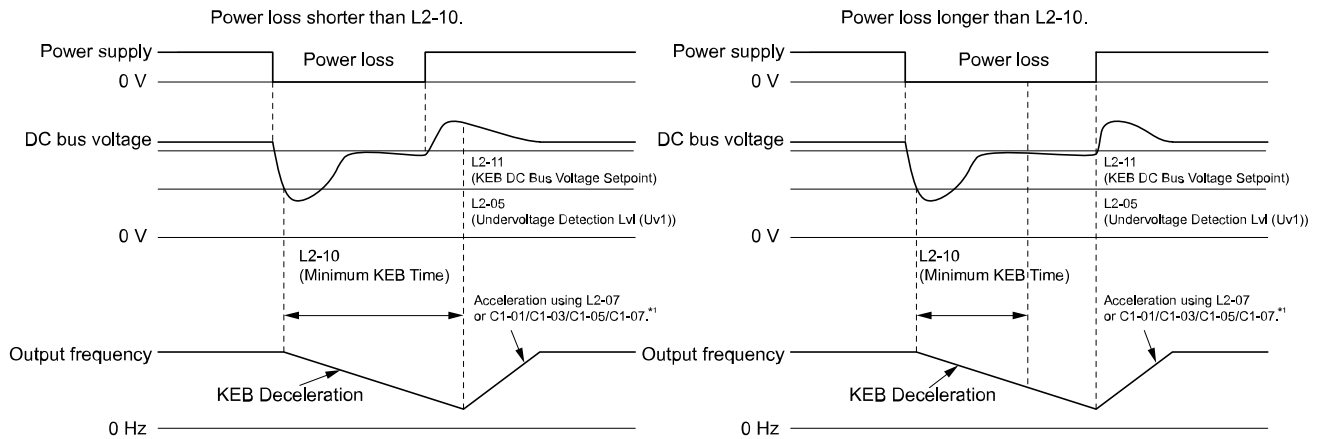
\*1 When *L2-07* = 0.00, the drive accelerates again as specified by the applicable *Acceleration Time* [*C1-01*, *C1-03*, *C1-05*, *C1-07*], and usual operation continues.

**Cancel KEB Operation When Restoration of Power Occurs while the Control Power (Power Supply to the Control Board) is Maintained**

Figure 11.130 shows an example with this configuration:

- *L2-01* = 4 [*Kinetic Energy Backup: CPU Power*] is set.
- KEB Ride-Thru is not used.

The drive starts deceleration through KEB operation. The drive decelerates for the time set in parameter *L2-10*, and then measures the DC bus voltage level. When the DC bus voltage is lower than the level set in *L2-11*, the drive uses the KEB Ride-Thru function to continue deceleration. When the DC bus voltage is more than the level set in *L2-11*, usual operation continues. The drive accelerates the motor to the frequency reference value before the power loss, and usual operation continues.



**Figure 11.130 Cancel KEB Operation without Using the KEB Ride-Thru if Restoration of Power Occurs while the Control Power (Power Supply to the Control Board) is Maintained**

\*1 When setting *L2-07* = 0.00, the drive reaccelerates in accordance with the valid *Acceleration Time* [*C1-01*, *C1-03*, *C1-05*, *C1-07*], and normal operation resumes.

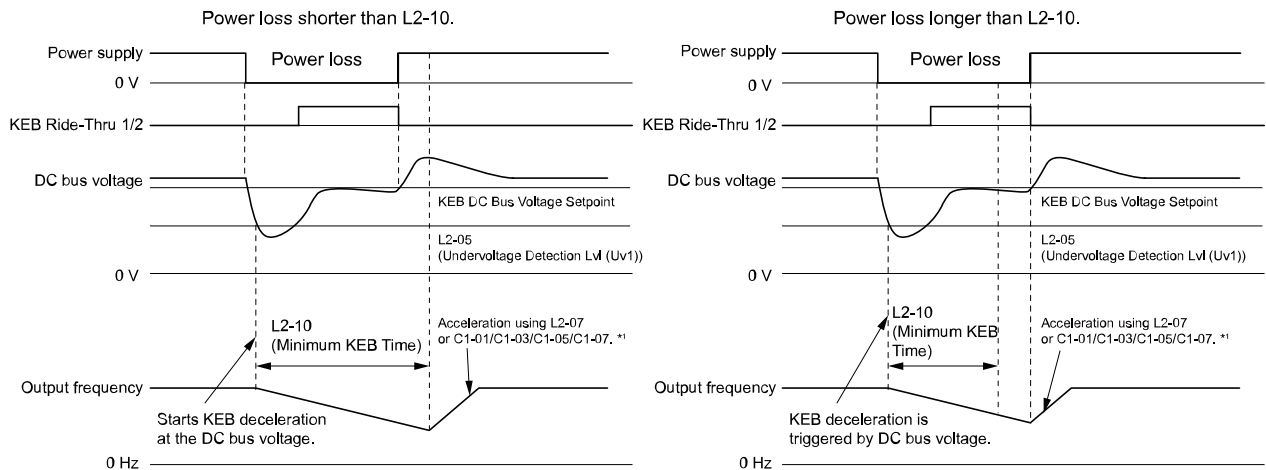
**Use the KEB Ride-Thru to Cancel KEB Operation when Restoration of Power Occurs while the Control Power (Power Supply to the Control Board) is Maintained**

Figure 11.131 shows an example with this configuration:

- *L2-01* = 4.
- Use *KEB Ride-Thru 1* [*H1-xx* = 65, 66] or *KEB Ride-Thru 2* [*H1-xx* = 7A, 7B].

The drive starts deceleration through KEB operation. When the motor decelerates for the time set in *L2-10*, the drive measures the DC bus voltage and the status of the digital input set for KEB Ride-Thru. When the DC bus voltage is less than the level set in *L2-11*, or if the digital input set to KEB Ride-Thru is active, deceleration continues. When the voltage level is more than the value set to *L2-11*, usual operation continues. The drive

accelerates the motor to the frequency reference value before the power loss, and usual operation continues. When the KEB Ride-Thru continues to be input after the time set in *L2-02* is expired, the drive uses the KEB Ride-Thru function to continue to decelerate. When you cancel the KEB Ride-Thru, the motor accelerates again, and usual operation continues.



**Figure 11.131 Use the KEB Ride-Thru to Cancel KEB Operation when Restoration of Power Occurs while the Control Power (Power Supply to the Control Board) is Maintained**

\*1 When *L2-07* = 0.00, the drive accelerates again as specified by the applicable *Acceleration Time* [*C1-01*, *C1-03*, *C1-05*, *C1-07*], and usual operation continues.

**KEB Operation when *L2-01* = 5 [Kinetic Energy Backup: DecelStop]**

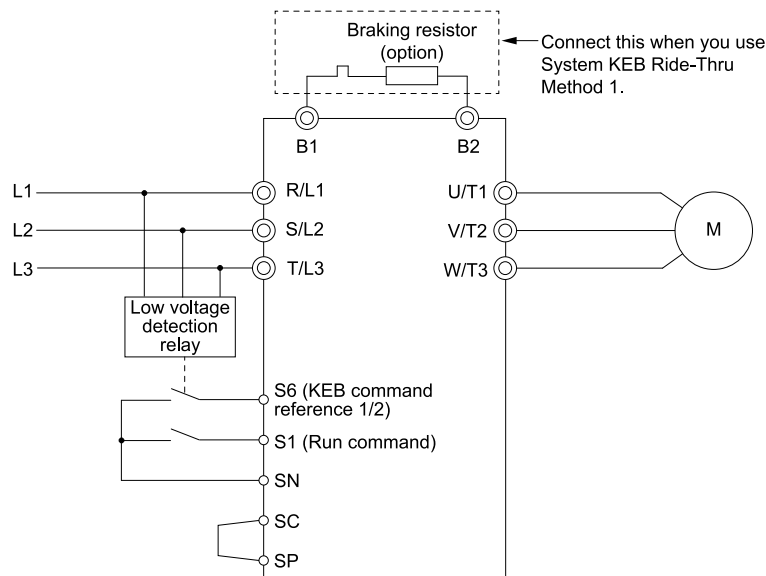
The drive starts deceleration through KEB operation. The drive will continue to decelerate until the motor comes to the minimum output frequency or a complete stop. If you return power during deceleration, the drive continues to decelerate. If you do not input the Run command, the motor cannot restart.

**KEB Operation Wiring Example**

Figure 11.132 shows an example that uses an undervoltage relay to trigger the KEB Ride-Thru at power loss. When a power loss occurs, the undervoltage relay triggers *KEB Ride-Thru* [*H1-06* = 65, 66, 7A, 7B] at terminal S6.

**Note:**

- A dynamic braking option is necessary for *System KEB Ride-Thru 1* [*L2-29* = 2].
- If you turn off the Run command, the drive will not accelerate back to speed when you return power.



**Figure 11.132 KEB Function Wiring Example**

**Parameters for KEB Ride-Thru**

Table 11.71 shows the parameters that adjust the KEB Ride-Thru function. Parameter settings are different for the different KEB methods set in *L2-29* [*Kinetic Energy Backup Method*].

Table 11.71 Parameters for KEB Ride-Thru

No.	Name	Setting Method	L2-29 [Kinetic Energy Backup Method]			
			0	1	2	3
C1-09	Fast Stop Time	<ul style="list-style-type: none"> <li>If <i>ov</i> [Overvoltage] occurs during KEB deceleration, increase the setting value.</li> <li>If <i>Uv1</i> [DC Bus Undervoltage] occurs during KEB deceleration, decrease the setting value.</li> </ul>	x *1	-	-	-
C2-03	S-Curve Time @ Start of Decel	<ul style="list-style-type: none"> <li>If <i>ov</i> [Overvoltage] occurs immediately after you start KEB deceleration, increase the setting value.</li> <li>If <i>Uv1</i> [DC Bus Undervoltage] occurs immediately after you start KEB deceleration, decrease the setting value.</li> </ul>	x	-	x	x
L2-05	Undervoltage Detection Lvl (Uv1)	If <i>Uv1</i> [DC Bus Undervoltage] occurs immediately after you start KEB deceleration, increase the setting value to detect power loss more quickly.	x	x	x	x
L2-06	Kinetic Energy Backup Decel Time	<ul style="list-style-type: none"> <li>Does KEB Tuning.</li> <li>If <i>ov</i> or <i>Uv1</i> occur during KEB deceleration after the KEB Tuning, set L2-06 as follows: <ul style="list-style-type: none"> <li>If <i>ov</i> occurs, increase the setting value</li> <li>If <i>Uv1</i> occurs, decrease the setting value</li> </ul> </li> </ul>	-	-	x *2	x *2
L2-07	Kinetic Energy Backup Accel Time	Sets the acceleration time to return to the frequency reference value before a power loss, after you cancel the KEB operation. When L2-07 = 0, the drive uses standard acceleration times set in C1-01, C1-03, C1-05, and C1-07 [Acceleration Time].	x	x	x	x
L2-08	Frequency Gain at KEB Start	<ul style="list-style-type: none"> <li>If <i>ov</i> [Overvoltage] occurs immediately after you start operation, decrease the setting value.</li> <li>If <i>Uv1</i> [DC Bus Undervoltage] occurs immediately after you start operation, increase the setting value.</li> </ul>	x	-	x	x
L2-10	Minimum KEB Time	<ul style="list-style-type: none"> <li>With KEB Ride-Thru There is <i>Uv1</i> because you set a digital input for KEB Ride-Thru and the device that controls the input operated too slowly after power loss.</li> <li>Without KEB Ride-Thru If the DC bus voltage overshoots immediately after KEB Ride-Thru starts, increase L2-10 to longer than the overshoot.</li> </ul>	x	x	x	x
L2-11	KEB DC Bus Voltage Setpoint	<ul style="list-style-type: none"> <li>Single Drive KEB Ride-Thru 2 Set to approximately 1.22 x input voltage.</li> <li>Single Drive KEB Ride-Thru 1, System KEB Ride-Thru 1, or System KEB Ride-Thru 2 Set to approximately 1.4 x input voltage.</li> </ul>	x	x	x	x
L3-20	DC Bus Voltage Adjustment Gain	<ul style="list-style-type: none"> <li>If <i>ov</i> or <i>Uv1</i> occur at the start of deceleration when you use KEB operation, increase this value in 0.1 unit increments.</li> <li>If there is torque ripple during deceleration when you use KEB Ride-Thru, decrease the value.</li> </ul>	-	x	-	-
L3-21	OVSUPPRESSION Accel/Decel P Gain	If there is large speed or current ripple, decrease the value in 0.05 unit increments. <b>Note:</b> If the setting value is too low, then the drive will have unsatisfactory DC bus voltage control response. The drive can detect <i>ov</i> or <i>Uv1</i> .	-	x	-	-
L3-24	Motor Accel Time @ Rated Torque	Set the motor acceleration time to the maximum frequency at the motor rated torque.	-	x	-	-
L3-25	Load Inertia Ratio	Sets the ratio between motor inertia and machine inertia.	-	x *3	-	-

\*1 When L2-29 = 0 [Kinetic Energy Backup Method = Single Drive KEB Ride-Thru 1], the drive will automatically set C1-09 [Fast Stop Time] in KEB Tuning. If you must not change the Fast Stop time, do not do KEB Tuning.

\*2 If you do KEB Tuning when L2-29 = 1, 2, or 3 [Kinetic Energy Backup Method = Single Drive KEB Ride-Thru 2, System KEB Ride-Thru 1 or System KEB Ride-Thru 2], the drive will automatically set L2-06 [Kinetic Energy Backup Decel Time].

\*3 The drive sets this value automatically when KEB Tuning completes correctly.

## ■ L2-01: Power Loss Ride Through Select

No. (Hex.)	Name	Description	Default (Range)
L2-01 (0485)	Power Loss Ride Through Select	<div style="display: flex; justify-content: space-between; font-size: 0.8em; font-weight: bold; margin-bottom: 5px;"> <span>V/f</span> <span>CL-V/f</span> <span>OLV</span> <span>CLV</span> <span>AOLV</span> <span>OLV/PM</span> <span>AOLV/PM</span> <span>CLV/PM</span> <span>EZOLV</span> </div> Sets the drive operation after a momentary power loss.	0 (0 - 5)

The drive detects momentary power loss when the drive DC bus voltage is less than the value set in *L2-05 [Undervoltage Detection Lvl (Uv1)]*.

### 0 : Disabled

A momentary power loss triggers *Uv1 [DC Bus Undervoltage]* is triggered when a momentary power loss occurs. If power is not restored within 15 ms, a *Uv1* is triggered and the drive shuts off the output. The motor coasts to stop.

### 1 : Enabled for L2-02 Time

When power returns in the time set in *L2-02 [Power Loss Ride Through Time]*, the drive will restart. If power does not return in the time set in *L2-02*, the drive will detect *Uv1*.

The drive momentarily turns OFF its output after a power loss. If the power returns in the time set to *L2-02*, the drive will do Speed Search and try to continue operation.

If the DC bus voltage is less than or equal to the *Uv1* detection level for the time set in *L2-02*, the drive will detect *Uv1* and output a fault signal.

#### Note:

- The necessary time for the drive to restart after power returns is different for different drive capacities.
- The upper limit of the possible momentary power loss Ride-Thru time is different for different drive models.

### 2 : Enabled while CPU Power Active

When power returns and the drive control circuit has power, the drive will restart. This will not trigger *Uv1*.

When there is a momentary power loss, the drive output will turn OFF. If the power returns and the drive control circuit has power, the drive will do Speed Search and try to continue operation. This will not trigger *Uv1*. This function lets the power loss be longer than when *L2-01 = 1*.

### 3 : Kinetic Energy Backup: L2-02

If power does not return in the time set in *L2-02*, the drive will detect *Uv1*.

When the drive detects momentary power loss, the drive will use regenerative energy from the motor through KEB operation to decelerate. When you return power in the time set in *L2-02*, the drive will accelerate to the frequency reference value that was used before the power loss. If you do not return power in the time set to *L2-02*, the drive will detect *Uv1* and the drive output will turn OFF. *L2-29 [Kinetic Energy Backup Method]* sets the type of KEB operation.

### 4 : Kinetic Energy Backup: CPU Power

When power returns and the drive control circuit has power, the drive will restart.

The drive decelerates using regenerative energy from the motor until the power returns and then restarts when a momentary power loss is detected. When power is restored during deceleration, the drive accelerates the motor again to the frequency reference value used before the power loss. If the motor comes to a stop before the power returns, the drive loses control power and the drive output shuts off. A *Uv1* is not triggered when power is restored while power to the CPU in the drive is maintained. The type of KEB operation is determined by *L2-29*.

### 5 : Kinetic Energy Backup: DecelStop

When power returns, the drive will continue to decelerate until the motor fully stops.

If the drive detects momentary power loss, the drive will use regenerative energy from the motor and ramp to stop. When you return power to the drive, the drive will continue to decelerate until the motor comes to a full stop. After you return power, the drive will ramp to stop in the set deceleration time. *L2-29* sets the type of KEB operation.

**Note:**

When you set L2-01, make sure that you know these items:

- You can use a Momentary Power Loss Unit on models 2004 to 2056 and 4002 to 4031 for a longer momentary power loss ride through time. A Momentary Power Loss Unit makes it possible to continue operation of the drive after a maximum of 2 seconds of power loss.
- When you set L2-01 = 1 to 4, keep the magnetic contactor between the motor and the drive closed and keep the control signal while the drive does KEB operation.
- When you set L2-01 = 1 to 5, Uv [Undervoltage] will flash on the keypad while the drive tries to recover from a momentary power loss. The drive will not output a fault signal at this time.
- When you use a magnetic contactor between the motor and the drive, keep the magnetic contactor closed while the drive does KEB operation or tries to restart with Speed Search.
- Keep the Run command active during KEB operation. The drive cannot accelerate back to the frequency reference when the power returns.
- When you set L2-01 = 3 to 5, if the control power supply voltage is less than the CPU operation level during KEB Ride-Thru, it will trigger Uv1.

■ **L2-02: Power Loss Ride Through Time**

No. (Hex.)	Name	Description	Default (Range)
L2-02 (0486)	Power Loss Ride Through Time	<div style="display: flex; justify-content: space-between; font-size: 0.8em; font-weight: bold; margin-bottom: 5px;"> <span>V/f</span> <span>CL-V/f</span> <span>OLV</span> <span>CLV</span> <span>AOLV</span> <span>OLV/PM</span> <span>AOLV/PM</span> <span>CLV/PM</span> <span>EZOLV</span> </div> Sets the maximum time that the drive will wait until trying to restart after power loss.	Determined by o2-04 and C6-01 (0.0 - 25.5 s)

This function is applicable when L2-01 = 1, 3 [Power Loss Ride Through Select = Enabled for L2-02 Time, Kinetic Energy Backup: L2-02]. If power loss operation is longer than the time set in this parameter, the drive will detect Uv1 [DC Bus Undervoltage], turn OFF output, and the motor will coast to stop.

**Note:**

- The length of time that the drive can recover after a power loss changes when drive capacity changes.
- The upper limit of the possible momentary power loss Ride-Thru time changes when drive capacity changes.

■ **L2-03: Minimum Baseblock Time**

No. (Hex.)	Name	Description	Default (Range)
L2-03 (0487)	Minimum Baseblock Time	<div style="display: flex; justify-content: space-between; font-size: 0.8em; font-weight: bold; margin-bottom: 5px;"> <span>V/f</span> <span>CL-V/f</span> <span>OLV</span> <span>CLV</span> <span>AOLV</span> <span>OLV/PM</span> <span>AOLV/PM</span> <span>CLV/PM</span> <span>EZOLV</span> </div> Sets the minimum baseblock time when the drive restores power after a momentary power loss.	Determined by o2-04 and C6-01 (0.1 - 5.0 s)

Sets the length of time that the drive will wait for the residual voltage in the motor to dissipate in estimation to the secondary circuit time constant of the motor. If oC [Overcurrent] or ov [DC Bus Overvoltage] occur at the start of Speed Search, after a power loss, or during DC Injection Braking, increase this setting.

■ **L2-04: Powerloss V/f Recovery Ramp Time**

No. (Hex.)	Name	Description	Default (Range)
L2-04 (0488)	Powerloss V/f Recovery Ramp Time	<div style="display: flex; justify-content: space-between; font-size: 0.8em; font-weight: bold; margin-bottom: 5px;"> <span>V/f</span> <span>CL-V/f</span> <span>OLV</span> <span>CLV</span> <span>AOLV</span> <span>OLV/PM</span> <span>AOLV/PM</span> <span>CLV/PM</span> <span>EZOLV</span> </div> Sets the time for the drive output voltage to go back to correct voltage after completing speed searches.	Determined by o2-04 and C6-01 (0.0 - 5.0 s)

Sets the time for voltage to recover from 0 V to the value set in E1-05 [Maximum Output Voltage].

■ **L2-05: Undervoltage Detection Lvl (Uv1)**

No. (Hex.)	Name	Description	Default (Range)
L2-05 (0489)	Undervoltage Detection Lvl (Uv1)	<div style="display: flex; justify-content: space-between; font-size: 0.8em; font-weight: bold; margin-bottom: 5px;"> <span>V/f</span> <span>CL-V/f</span> <span>OLV</span> <span>CLV</span> <span>AOLV</span> <span>OLV/PM</span> <span>AOLV/PM</span> <span>CLV/PM</span> <span>EZOLV</span> </div> Sets the voltage at which a Uv1 [DC Bus Undervoltage] fault is triggered or at which the KEB function is activated. Usually it is not necessary to change this setting.	Determined by E1-01 (Determined by E1-01)

**NOTICE: Damage to Equipment.** Install an AC reactor option on the input side of the power supply when setting this parameter lower than the default value. Failure to obey will cause damage to drive circuitry.



**Note:**

If the low voltage detection level is near the lower limit value of L2-05, the drive will detect *Uv1* during KEB Ride-Thru operation. Do not set the value too low when you use the KEB Ride-Thru function.

■ **L2-06: Kinetic Energy Backup Decel Time**

No. (Hex.)	Name	Description	Default (Range)
L2-06 (048A) Expert	Kinetic Energy Backup Decel Time	<input type="checkbox"/> V/f <input type="checkbox"/> CL-V/f <input type="checkbox"/> OLV <input type="checkbox"/> CLV <input type="checkbox"/> AOLV <input type="checkbox"/> OLV/PM <input type="checkbox"/> AOLV/PM <input type="checkbox"/> CLV/PM <input type="checkbox"/> EZOLV Sets the deceleration time during KEB operation used to decrease the maximum output frequency to 0.	0.0 s (0.0 to 6000.0 s)

Set L2-29 = 2 or 3 [Kinetic Energy Backup Method = System KEB Ride-Thru 1 or System KEB Ride-Thru 2] to enable this function. When L2-29 = 1, 2, 3 [Kinetic Energy Backup Method = Single Drive KEB Ride-Thru 2, System KEB Ride-Thru 1, System KEB Ride-Thru 2] and you do KEB Auto-Tuning, the drive will automatically set this value.

Sets the deceleration time necessary to decelerate from the frequency reference to 0 Hz when the drive detects a momentary power loss. If a *Uv1* [DC Bus Undervoltage] fault occurs during KEB operation, decrease the deceleration time. If an *ov* [Overvoltage] fault occurs, increase the deceleration time.

• L2-06 = 0

The drive automatically decreases C1-09 [Fast Stop Time] to the base value to keep the DC bus voltage above the low voltage detection level. The drive ignores L2-02 [Momentary Power Loss Ride-Thru Time] in this condition.

• L2-06 ≠ 0

As shown in Figure 11.133, the frequency reference decelerates to the KEB frequency level as specified by the deceleration rate set in L2-06 and then returns to the initial frequency reference as specified by C1-01 [Acceleration Time 1]. The drive uses the setting value of the KEB frequency rate as shown in the this formula to set the KEB frequency level:

$$\text{KEB frequency level} = \text{Output frequency before power loss} \times (1 - (L2-02) / (L2-06))$$

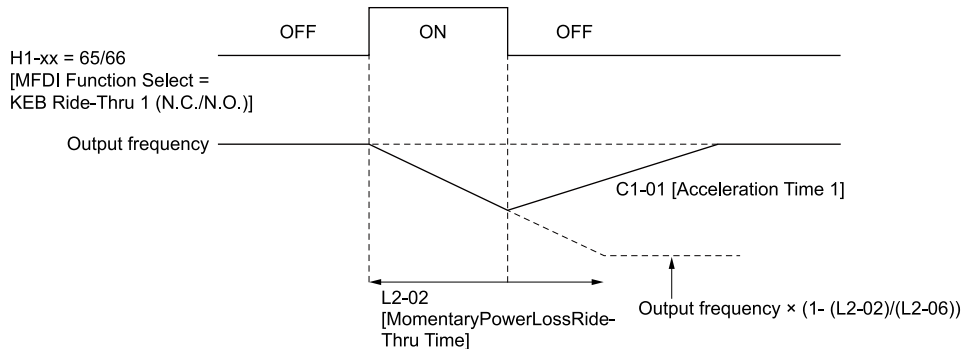


Figure 11.133 Kinetic Energy Backup Decel Time

■ **L2-07: Kinetic Energy Backup Accel Time**

No. (Hex.)	Name	Description	Default (Range)
L2-07 (048B) Expert	Kinetic Energy Backup Accel Time	<input type="checkbox"/> V/f <input type="checkbox"/> CL-V/f <input type="checkbox"/> OLV <input type="checkbox"/> CLV <input type="checkbox"/> AOLV <input type="checkbox"/> OLV/PM <input type="checkbox"/> AOLV/PM <input type="checkbox"/> CLV/PM <input type="checkbox"/> EZOLV Sets the acceleration time to return the frequency to the frequency reference before a power loss after canceling KEB operation.	0.0 s (0.0 to 6000.0 s)

Set this parameter to 0.0 to disable the function. The drive uses the acceleration time in C1-01, C1-03, C1-05, and C1-07 to accelerate again after KEB operation completes.

■ **L2-08: Frequency Gain at KEB Start**

No. (Hex.)	Name	Description	Default (Range)
L2-08 (048C) Expert	Frequency Gain at KEB Start	<input type="checkbox"/> V/f <input type="checkbox"/> CL-V/f <input type="checkbox"/> OLV <input type="checkbox"/> CLV <input type="checkbox"/> AOLV <input type="checkbox"/> OLV/PM <input type="checkbox"/> AOLV/PM <input type="checkbox"/> CLV/PM <input type="checkbox"/> EZOLV Sets the quantity of output frequency reduction used when KEB operation starts as a percentage of the motor rated slip before starting KEB operation.	100% (0 - 300%)

Decreases the output frequency in steps to quickly set the motor to a regenerative condition. Use this formula to calculate the value:

$$\text{Output frequency reduction} = \text{Motor rated slip before KEB operation} \times (L2-08/100) \times 2$$

■ **L2-09: KEB Minimum Frequency Level**

No. (Hex.)	Name	Description	Default (Range)
L2-09 (048D) Expert	KEB Minimum Frequency Level	<b>V/f</b> <b>CL-V/f</b> <b>OLV</b> <b>CLV</b> <b>AOLV</b> <b>OLV/PM</b> <b>AOLV/PM</b> <b>CLV/PM</b> <b>EZOLV</b> Sets the quantity of output frequency reduction used when KEB operation starts as a percentage of the motor rated slip.	20% (0 - 100%)

These conditions set the quantity of decrease:

- Motor rated slip  $\times (L2-09/100)$
- The larger value between the value calculated with *L2-08* and the value calculated with *L2-09*

■ **L2-10: Minimum KEB Time**

No. (Hex.)	Name	Description	Default (Range)
L2-10 (048E) Expert	Minimum KEB Time	<b>V/f</b> <b>CL-V/f</b> <b>OLV</b> <b>CLV</b> <b>AOLV</b> <b>OLV/PM</b> <b>AOLV/PM</b> <b>CLV/PM</b> <b>EZOLV</b> Sets the minimum length of time to operate the KEB after the drive detects a momentary power loss.	50 ms (0 - 25500 ms)

When you return power while KEB is operating, the drive continues KEB operation until the time set in *L2-10* is expired. When the DC bus voltage is less than the level of *L2-05* [*Undervoltage Detect Level (Uv1)*] in one of these conditions, KEB operation continues until the time set in *L2-10* is expired:

- *L2-01* = 3 [Momentary Power Loss Ope Select = KEB Mode].
- *L2-01* = 4 [KEB Stop Mode]
- *L2-01* = 5 [KEB Decel to Stp].
- KEB Ride-Thru 1/2 [H1-xx = 65, 66, 7A, or 7B] is input into the drive.

When you input KEB Ride-Thru, KEB operation continues after the time set in *L2-10* is expired. When you cancel KEB Ride-Thru, the motor accelerates again. When you do not input KEB Ride-Thru during the time set in *L2-10*, the drive accelerates to the frequency reference that the drive had before power loss in the applicable acceleration time.

When *L2-01* = 3, 4, or 5, and the DC bus voltage is a minimum of the value of *L2-11* [*DC Bus Vol Setpoint during KEB*], the drive accelerates again after the time set in *L2-10* is expired. If the DC bus voltage is less than the *L2-11* value, KEB operation continues after the time set in *L2-10* is expired.

**Note:**

- When *L2-01* = 0, 1, or 2 [*Disabled, Enabled, or Enabled when CPU is Running*], increase the value of *L2-10*. Set *L2-10* to cancel KEB operation if the KEB Ride-Thru is not input
- Set this parameter to 0 to disable the function.

■ **L2-11: KEB DC Bus Voltage Setpoint**

No. (Hex.)	Name	Description	Default (Range)
L2-11 (0461) Expert	KEB DC Bus Voltage Setpoint	<b>V/f</b> <b>CL-V/f</b> <b>OLV</b> <b>CLV</b> <b>AOLV</b> <b>OLV/PM</b> <b>AOLV/PM</b> <b>CLV/PM</b> <b>EZOLV</b> Sets the target value that controls the DC bus voltage to a constant level in Single Drive KEB Ride-Thru 2. Sets the DC bus voltage level that completes the KEB operation for all other KEB methods.	Determined by E1-01 (Determined by E1-01)

■ **L2-29: Kinetic Energy Backup Method**

No. (Hex.)	Name	Description	Default (Range)
L2-29 (0475) Expert	Kinetic Energy Backup Method	<b>V/f</b> <b>CL-V/f</b> <b>OLV</b> <b>CLV</b> <b>AOLV</b> <b>OLV/PM</b> <b>AOLV/PM</b> <b>CLV/PM</b> <b>EZOLV</b> Sets the KEB function operation mode.	0 (0 - 3)

Set  $L2-01 = 3, 4, \text{ or } 5$  [*Momentary Power Loss Ope Select = KEB Mode, KEB Stop Mode, or KEB Decel to Stp*] or *KEB Ride-Thru 1/2* [ $H1-xx = 65, 66, 7A, \text{ or } 7B$ ], to enable the KEB function.

### 0 : Single Drive KEB Ride-Thru 1

The drive monitors the DC bus voltage and uses regenerative energy from the motor to hold the DC bus voltage at the level set in  $L2-11$  [*KEB DC Bus Voltage Setpoint*].

The KEB operation continues and the deceleration rate changes as specified by  $C1-09$  [*Fast Stop Time*].

**Note:**

- If the drive detects  $Uv1$  [*DC Bus Undervoltage*] during KEB operation, decrease the value of  $C1-09$ .
- If the drive detects  $ov$  [*Overvoltage*] during KEB operation, increase the value of  $C1-09$ .

### 1 : Single Drive KEB Ride-Thru 2

The drive does KEB operation and automatically calculates the deceleration rate to make sure that the main circuit electrical energy and main current voltage from motor regenerative energy is equal to  $L2-11$  [*DC Bus Vol Setpoint during KEB*].

### 2 : System KEB Ride-Thru 1

The drive does not monitor the DC bus voltage and decelerates as specified by the KEB deceleration time set in  $L2-06$ .

Set  $L2-06$  to the time necessary to decelerate from the frequency reference to 0 Hz when the drive detects a momentary power loss. The drive can decelerate and keep constant deceleration rates for more than one drive.

**Note:**

If you keep constant deceleration rates for more than one drive, it can trigger  $ov$  faults. Use the dynamic braking option with System KEB Ride-Thru 1 to prevent  $ov$  faults.

### 3 : System KEB Ride-Thru 2

The drive monitors the DC bus voltage and decelerates for the deceleration time set in  $L2-06$ .

If the DC bus voltage increases, the drive momentarily holds the frequency to prevent  $ov$  while deceleration continues.

**Note:**

When you cannot use a dynamic braking option, use System KEB Ride-Thru.

## ■ L2-30: KEB Zero Speed Operation

No. (Hex.)	Name	Description	Default (Range)
L2-30 (045E) Expert	KEB Zero Speed Operation	<div style="display: flex; gap: 5px;"> <span>V/f</span> <span>CL-V/f</span> <span>OLV</span> <span>CLV</span> <span>AOLV</span> <span>OLV/PM</span> <span>AOLV/PM</span> <span>CLV/PM</span> <span>EZOLV</span> </div> <p>Sets the operation when the output frequency decreases below the zero level (DC braking injection starting frequency) during <i>KEB deceleration</i> when <math>L2-01 = 3 \text{ to } 5</math> [<i>Momentary Power Loss Ope Select = KEB Mode, KEB Stop Mode, or KEB Decel to Stp</i>].</p>	0 (0, 1)

### 0 : Baseblock

### 1 : DC/SC Braking

Does DC injection braking and short circuit braking as specified by  $b2-04$  [*DC Inject Braking Time at Stop*] and  $b2-13$  [*Short Circuit Brake Time @ Stop*].

## ■ L2-31: KEB Start Voltage Offset Level

No. (Hex.)	Name	Description	Default (Range)
L2-31 (045D) Expert	KEB Start Voltage Offset Level	<div style="display: flex; gap: 5px;"> <span>V/f</span> <span>CL-V/f</span> <span>OLV</span> <span>CLV</span> <span>AOLV</span> <span>OLV/PM</span> <span>AOLV/PM</span> <span>CLV/PM</span> <span>EZOLV</span> </div> <p>Sets the KEB start voltage offset.</p>	Determined by A1-02 (200 V Class: 0 - 100 V, 400 V Class: 0 - 200 V)

The drive uses this formula to calculate the KEB start voltage:

$$\text{KEB start voltage} = L2-05 [\text{Undervoltage Detect Level (Uv1)}] + L2-31$$

## ◆ L3: Stall Prevention

$L3$  parameters set the Stall Prevention function and overvoltage suppression function.

■ **Stall Prevention**

If the load is too heavy or the acceleration and deceleration times are too short, the motor can slip too much because it cannot work at the same rate as the frequency reference. If the motor stalls during acceleration, current increases as the slip increases to cause an *oC* [Overcurrent], *oL2* [Drive Overload], or *oL1* [Motor Overload] and the drive will stop. If the motor stalls during deceleration, too much regenerative power will flow back into the DC bus capacitors, and cause the drive to fault out from *ov* [Overvoltage] and the drive will stop.

The stall prevention function will let the motor get to the set speed without stalling and it is not necessary for you to change the acceleration or deceleration time settings. You can set a separate stall prevention functions for acceleration, operating at constant speeds, and deceleration.

■ **Overvoltage Suppression Function**

Decreases the regenerative torque limit and increases the output frequency when the DC bus voltage increases to prevent *ov*. This function can drive loads with cyclic regenerative operation, for example punch presses or other applications with repeated crank movements. When you use this function, set *L3-11* = 1 [Overvoltage Suppression Select = Enabled].

The drive adjusts the regenerative torque limit and the output frequency during overvoltage suppression to make sure that the DC bus voltage is not more than the level set in *L3-17* [DC Bus Regulation Level].

Set these parameters as necessary when you use the overvoltage suppression function:

- *L3-20* [DC Bus Voltage Adjustment Gain]
- *L3-21* [OVSuppression Accel/Decel P Gain]
- *L3-24* [Motor Accel Time @ Rated Torque]
- *L3-25* [Load Inertia Ratio]

**Note:**

- When overvoltage suppression is triggered, the motor speed is more than the frequency reference. Do not use overvoltage suppression for applications where the frequency reference and the motor speed must align.
- When you use a braking resistor, set *L3-11* = 0 [Disabled].
- The overvoltage suppression function is enabled only when you operate immediately below the maximum frequency. Overvoltage suppression does not increase the output frequency to more than the maximum frequency. Make sure that the motor and machine specifications are correct for the application, then increase the maximum frequency.
- If there is a sudden increase to a regenerative load, *ov* can occur.

■ **L3-01: Stall Prevention during Accel**

No. (Hex.)	Name	Description	Default (Range)
L3-01 (048F)	Stall Prevention during Accel	<div style="display: flex; justify-content: space-between; font-size: small;"> <span>V/f</span> <span>CL-V/f</span> <span>OLV</span> <span>CLV</span> <span>AOLV</span> <span>OLV/PM</span> <span>AOLV/PM</span> <span>CLV/PM</span> <span>EZOLV</span> </div> Sets the method of the Stall Prevention During Acceleration.	1 (0 - 3)

**Note:**

When *A1-02* = 5 [Control Method Selection = PM Open Loop Vector], the setting range is 0 and 1 .

Stall prevention during acceleration will not let motors stall or stop when the drive detects *oC* [Overcurrent], *oL2* [Drive Overload], or *oL1* [Motor Overload] and large loads are applied during acceleration or when setting sudden acceleration times regarding load inertia.

**0 : Disabled**

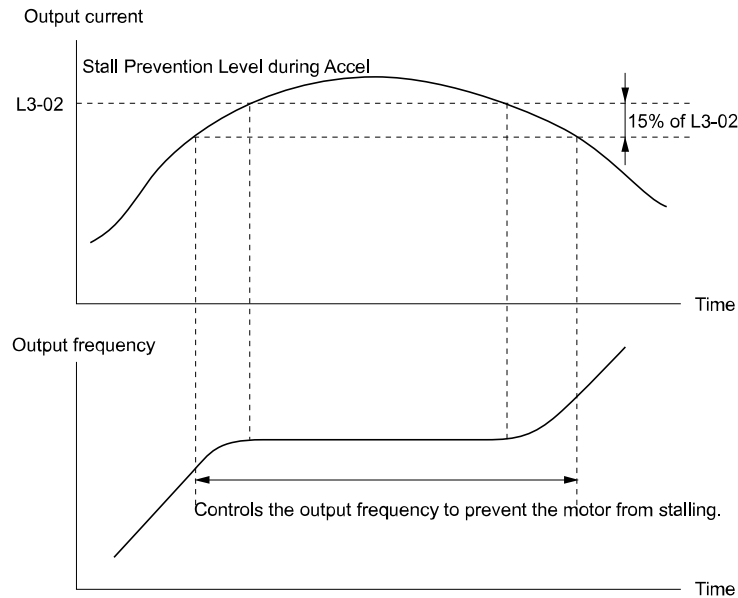
The Stall Prevention function does not operate during acceleration, and acceleration occurs for the set acceleration time. If the acceleration time is too short, the motor does not fully accelerate during the set time, which causes the drive to detect *oL1* or *oL2* and the motor to stop.

**1 : Enabled**

Enables the Stall Prevention During Acceleration function. Operation is different for different control methods.

• **V/f Control, Open Loop Vector Control, or EZ Open Loop Vector Control**

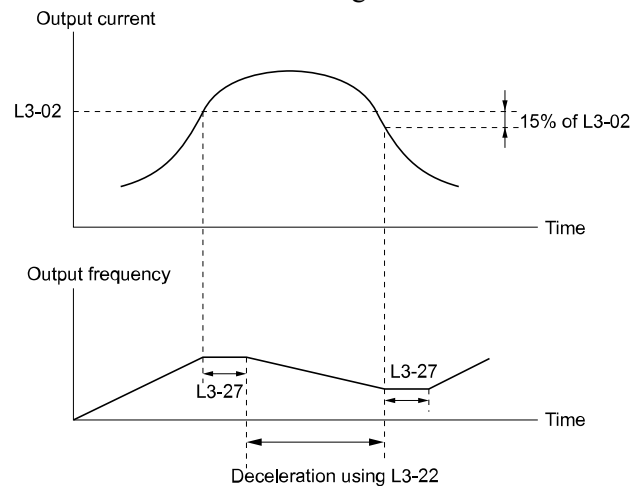
When the output current is more than the value set in *L3-02* [Stall Prevent Level during Accel], the drive stops acceleration. When the output current is less than the value set in *L3-02* - 15%, the drive starts to accelerate again. The Stall Prevention function level automatically falls for constant output ranges.



**Figure 11.134 Stall Prevention During Acceleration when Using Induction Motors**

- **Open Loop Vector Control for PM**

When the output current is more than the value set in *L3-02*, the drive stops acceleration. When the time set in *L3-27* [Stall Prevention Detection Time] is expired and the output current is the value set in *L3-02* at a minimum, the drive will start deceleration in as specified by the value set in *L3-22* [PM Stall Prevention Decel Time]. When the output current is less than the value set in *L3-02* - 15%, the drive stops deceleration. When the time set in *L3-27* is expired, the drive starts acceleration again.



**Figure 11.135 Stall Prevention During Acceleration Function in OLV/PM**

## 2 : Intelligent (Ignore Accel Ramp)

The drive ignores the acceleration time setting and the drive starts to accelerate in the minimum length of time. The drive automatically adjusts the acceleration rate and the output current will not be more than the value set in *L3-02*.

## 3 : Current Limit Method

This function limits the output current with the value set for *L3-02* and automatically adjusts the acceleration rate. When the load (output current) increases to more than the current limit level during acceleration, the drive automatically adjusts the acceleration rate.

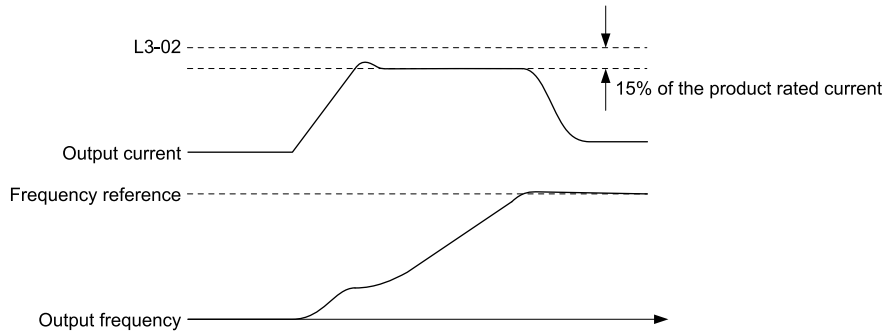


Figure 11.136 Current Limit Acceleration

■ L3-02: Stall Prevent Level during Accel

No. (Hex.)	Name	Description	Default (Range)
L3-02 (0490)	Stall Prevent Level during Accel	<input type="checkbox"/> V/f <input type="checkbox"/> CL-V/f <input type="checkbox"/> OLV <input type="checkbox"/> CLV <input type="checkbox"/> AOLV <input checked="" type="checkbox"/> OLV/PM <input type="checkbox"/> AOLV/PM <input type="checkbox"/> CLV/PM <input type="checkbox"/> EZOLV Sets the output current level to start Stall Prevention during acceleration as a percentage of the drive rated output current.	Determined by C6-01 and L8-38 (0 - 150%)

**Note:**

- If you use a motor that is small compared to the drive and the motor stalls, decrease the setting value.
- When you operate the motor in the constant power range, set L3-03 [Stall Prevent Limit during Accel].

■ L3-03: Stall Prevent Limit during Accel

No. (Hex.)	Name	Description	Default (Range)
L3-03 (0491)	Stall Prevent Limit during Accel	<input type="checkbox"/> V/f <input type="checkbox"/> CL-V/f <input type="checkbox"/> OLV <input type="checkbox"/> CLV <input type="checkbox"/> AOLV <input checked="" type="checkbox"/> OLV/PM <input type="checkbox"/> AOLV/PM <input type="checkbox"/> CLV/PM <input type="checkbox"/> EZOLV Sets the lower limit for the stall prevention level during acceleration used for constant output ranges as a percentage of the drive rated output current.	50% (0 - 100%)

The stall prevention level set in L3-02 [Stall Prevent Level during Accel] is automatically reduced when the motor is running within the constant output range. Parameter L3-03 is the limit value used to prevent the stall prevention level during constant output ranges to fall below the minimum required level.

**Note:**

The function to automatically reduce the stall prevention level does not operate when L3-01 = 3 [Stall Prevention during Accel = Current Limit Method].

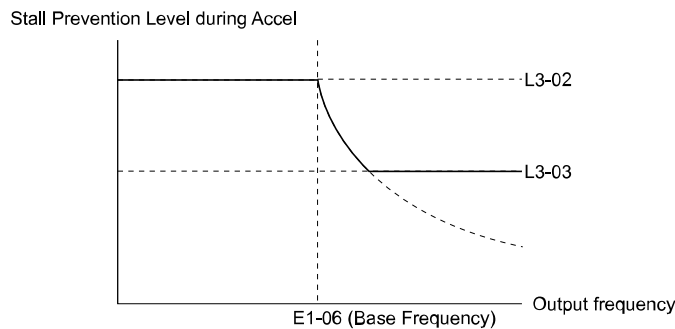


Figure 11.137 Stall Prevent Level during Accel/Limit

■ L3-04: Stall Prevention during Decel

No. (Hex.)	Name	Description	Default (Range)
L3-04 (0492)	Stall Prevention during Decel	<input type="checkbox"/> V/f <input type="checkbox"/> CL-V/f <input type="checkbox"/> OLV <input type="checkbox"/> CLV <input type="checkbox"/> AOLV <input checked="" type="checkbox"/> OLV/PM <input type="checkbox"/> AOLV/PM <input type="checkbox"/> CLV/PM <input type="checkbox"/> EZOLV Sets the method that the drive will use to prevent overvoltage faults when decelerating.	1 (Determined by A1-02)

**Note:**

- To connect a dynamic braking option (braking resistor or braking resistor unit) to the drive, set this parameter to 0 or 3. Parameter values 1, 2, 4, and 5 will enable Stall Prevention function during deceleration, and the dynamic braking option will not function.
- The setting range changes when the A1-02 [Control Method Selection] value changes:
  - When A1-02 = 5 [PM Open Loop Vector], setting range is 0 to 2
  - When A1-02 = 6, 7, or 8 [PM Advanced Open Loop Vector, PM Closed Loop Vector, or EZ Vector Control], setting range is 0, 1.

Stall Prevention during deceleration controls the deceleration as specified by the DC bus voltage and does not let high inertia or fast deceleration cause *ov* [Overvoltage] faults.

**0 : Disabled**

The drive decelerates as specified by the deceleration time. If the deceleration time is too short, the drive can detect an *ov* fault.

**Note:**

If an *ov* fault occurs, connect a dynamic braking option to the drive. If an *ov* fault occurs after you connect a dynamic braking option and A1-02 = 0 or 2 [Control Method Selection = V/f Control or Open Loop Vector] and L3-04 = 0, set L3-04 = 3.

**1 : General Purpose**

The drive decelerates as specified by the deceleration time. When the DC bus voltage is more than the Stall Prevention level, the drive stops deceleration until the DC bus voltage is less than the Stall Prevention Level. The drive then starts to decelerate at the set deceleration time. Frequent use of Stall Prevention will help prevent *ov* faults when the deceleration time is shorter than the drive can usually accept.

**Note:**

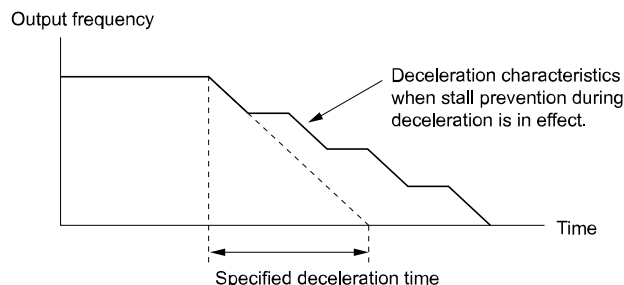
The Decel Stall Prevention function will increase the deceleration time to stop and the deceleration time will be longer than the setting. This function is not applicable for conveyor applications because the precision of the stop position is very important. As an alternative, use a dynamic braking option in these applications.

The input voltage setting of E1-01 [Input AC Supply Voltage] sets the DC bus voltage level for Stall Prevention.

**Table 11.72 Stall Prevention Level during Deceleration**

Drive Input Voltage	Stall Prevention Level during Deceleration
200 V class	377 V
400 V class	754 V

Figure 11.138 shows the Stall Prevention during deceleration function.

**Figure 11.138 Stall Prevention Operation during Deceleration****2 : Intelligent (Ignore Decel Ramp)**

The drive adjusts the deceleration rate to keep the DC bus voltage at the L3-17 [DC Bus Regulation Level] level. This makes the shortest possible deceleration time and will not let the motor stall. The drive ignores the selected deceleration time and the possible deceleration time cannot be less than 1/10 of the set deceleration time.

This function uses these parameters to adjust the deceleration rate:

- L3-20 [DC Bus Voltage Adjustment Gain]
- L3-21 [OVSuppression Accel/Decel P Gain]
- L3-24 [Motor Accel Time @ Rated Torque]
- L3-25 [Load Inertia Ratio]

**Note:**

The deceleration time is not constant. For applications where the precision of the stop position is very important, use a dynamic braking option and set L3-04 = 0. If an *ov* occurs, set L3-04 = 3.

**3 : General Purpose w/ DB resistor**

A braking resistor is necessary for this setting. The braking resistor and the drive work together for the Stall Prevention during deceleration function.

#### 4 : Overexcitation/High Flux

Enables Overexcitation/High Flux and enables a shorter deceleration time than when  $L3-04 = 0$ .

**Note:**

- If the overexcitation time is long and you decelerate frequently, the drive can detect  $oL1$  [Motor Overload] faults. If the drive detects  $oL1$ , decrease the deceleration time or install a braking resistor to the drive.
- The deceleration time during Overexcitation Deceleration changes when the motor characteristics and machine inertia change. Adjust the  $n3-13$  [OverexcitationBraking (OEB) Gain] and  $n3-23$  [Overexcitation Braking Operation] levels. Refer to “n3: HighSlip/OverexciteBraking” for more information.

#### 5 : Overexcitation/High Flux 2

Enables Overexcitation/High Flux 2. This function decreases the possible deceleration time more than Overexcitation/High Flux.

The drive decreases motor speed and tries to keep the DC bus voltage at the  $L3-17$  level.

If the drive detects  $oL1$ , decrease the values set in  $n3-13$  and  $n3-21$ . If the drive detects  $ov$ , increase the values set in  $C1-02$ ,  $C1-04$ ,  $C1-06$ , and  $C1-08$  [Deceleration Times].

**Note:**

- During Overexcitation/High Flux 2, the drive disables Hunting Prevention in V/f Control and also disables Speed Control that uses torque limit in OLV Control.
- Refer to “n3: HighSlip/OverexciteBraking” for more information.

### ■ L3-05: Stall Prevention during RUN

No. (Hex.)	Name	Description	Default (Range)
L3-05 (0493)	Stall Prevention during RUN	<div style="display: flex; justify-content: space-between; font-size: 0.8em; font-weight: bold;"> <span>V/f</span> <span>CL-V/f</span> <span>OLV</span> <span>CLV</span> <span>AOLV</span> <span>OLV/PM</span> <span>AOLV/PM</span> <span>CLV/PM</span> <span>EZOLV</span> </div> <p>Sets the function to enable and disable Stall Prevention During Run.</p>	Determined by A1-02 (0 - Determined by A1-02)

When the drive detects  $oL1$  [Motor Overload] while the motor is operating at constant speed, the Stall Prevention function during run automatically decreases the speed to prevent motor stalling.

**Note:**

An output frequency less than 6 Hz will disable Stall Prevention during Run regardless of  $L3-05$  and  $L3-06$  [Stall Prevent Level during Run] settings.

#### 0 : Disabled

The drive runs at the set frequency reference. A heavy load can cause the drive to detect  $oC$  [Overcurrent] or  $oL1$  and the motor will stall.

#### 1 : Deceleration Time 1 (C1-02)

The drive will decelerate for the time set in  $C1-02$  [Deceleration Time 1] when the current is more than the Stall Prevention level set in  $L3-06$ . When the current level is less than the “ $L3-06$  setting value - 2%” for 100 ms, the drive accelerates again for the acceleration time applicable at that time until it reaches the set frequency.

#### 2 : Deceleration Time 2 (C1-04)

This setting functions the same as *Setting 1 [Deceleration Time 1 (C1-02)]*. When the Stall Prevention function is enabled, the drive decelerates with the value set in  $C1-04$  [Deceleration Time 2].

#### 3 : Intelligent

The drive adjusts the deceleration rate to keep the output current at the level set in  $L3-06$  [Stall Prevent Level during Run]. The drive operates with the largest possible output current and prevents motor stalling.

### ■ L3-06: Stall Prevent Level during Run

No. (Hex.)	Name	Description	Default (Range)
L3-06 (0494)	Stall Prevent Level during Run	<div style="display: flex; justify-content: space-between; font-size: 0.8em; font-weight: bold;"> <span>V/f</span> <span>CL-V/f</span> <span>OLV</span> <span>CLV</span> <span>AOLV</span> <span>OLV/PM</span> <span>AOLV/PM</span> <span>CLV/PM</span> <span>EZOLV</span> </div> <p>Sets the current level that starts Stall Prevention during run. A setting of 100% is equal to the drive rated current.</p>	Determined by C6-01 and L8-38 (30 - 150%)

**Note:**

- This parameter is applicable if  $L3-05 = 1, 2$  [Stall Prevention during RUN = Deceleration Time 1 (C1-02), Deceleration Time 2 (C1-04)].
- When  $L3-23 = 1$  [Stall P Reduction at Constant HP = Automatic Reduction @ CHP Region], the drive will automatically decrease the level in the constant power range.



### Use an Analog Input to Change the Stall Prevent Level during Run

When  $H3-xx = 8$  [*MFAI Function Select = Stall Prevent Level During Run*], you can change the stall prevention level during run through the input gain and bias settings for terminals A1, A2, and A3.

If you set the input level for terminals A1, A2, and A3 [ $H3-xx = 8$ ] and L3-06, the drive will use the smaller value for Stall Prevent Level during Run.

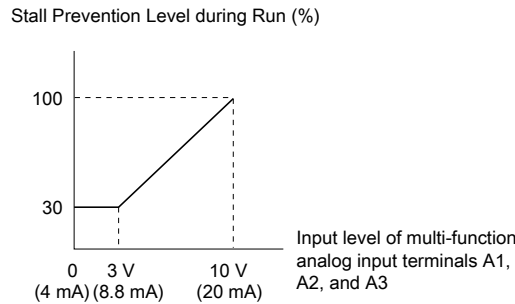


Figure 11.139 Stall Prevention Level during Run with Analog Input

### ■ L3-11: Overvoltage Suppression Select

No. (Hex.)	Name	Description	Default (Range)
L3-11 (04C7)	Overvoltage Suppression Select	<b>V/f</b> <b>CL-V/f</b> <b>OLV</b> <b>CLV</b> <b>AOLV</b> <b>OLV/PM</b> <b>AOLV/PM</b> <b>CLV/PM</b> <b>EZOLV</b> Sets the overvoltage suppression function.	0 (0, 1)

#### 0 : Disabled

The drive does not adjust the regenerative torque limit or the output frequency. If you apply a regenerative load, the drive can detect an *ov* [*Overvoltage*] fault. Use this setting with a dynamic braking option.

#### 1 : Enabled

When a regenerative load increases the DC bus voltage, the drive decreases the regenerative torque limit and increases the output frequency to prevent *ov*

### ■ L3-17: DC Bus Regulation Level

No. (Hex.)	Name	Description	Default (Range)
L3-17 (0462)	DC Bus Regulation Level	<b>V/f</b> <b>CL-V/f</b> <b>OLV</b> <b>CLV</b> <b>AOLV</b> <b>OLV/PM</b> <b>AOLV/PM</b> <b>CLV/PM</b> <b>EZOLV</b> Sets the target value for the DC bus voltage when the overvoltage suppression function and the Decel Stall Prevention function (Intelligent Stall Prevention) are active.	200 V Class: 375 V, 400 V Class: 750 V (200 V Class: 150 - 400 V, 400 V Class: 300 - 800 V)

#### Note:

This value is initialized when *E1-01* [*Input AC Supply Voltage*] is changed.

Sets this parameter for any of the following circumstances.

- $L3-11 = 1$  [*OV Suppression Function Select = Enabled*].
- $L3-04 = 2$  [*Decel Stall Prevention Selection = Automatic Decel Reduction*].

### ■ L3-20: DC Bus Voltage Adjustment Gain

No. (Hex.)	Name	Description	Default (Range)
L3-20 (0465) Expert	DC Bus Voltage Adjustment Gain	<b>V/f</b> <b>CL-V/f</b> <b>OLV</b> <b>CLV</b> <b>AOLV</b> <b>OLV/PM</b> <b>AOLV/PM</b> <b>CLV/PM</b> <b>EZOLV</b> Sets the proportional gain used to control the DC bus voltage.	Determined by A1-02 (0.00 - 5.00)

Set one of these parameters to enable L3-20:

- $L2-29 = 1$  [*KEB Method Selection = Single Drive KEB Ride-Thru 2*]
- $L3-04 = 2$  [*Decel Stall Prevention Selection = Automatic Decel Reduction*]
- $L3-11 = 1$  [*OV Suppression Function Select = Enabled*]
- $H1-xx = 7A$  or  $7B$  [*MFDI Function Select = KEB Ride-Thru 2 (N.O./N.C.)*]

**Note:**

- If stall prevention during deceleration function causes *ov* [Overvoltage] and *Uv1* [DC Bus Undervoltage] faults when you start deceleration and *L2-29* = 1, *H1-xx* = 7A or 7B, or *L3-04* = 2, gradually increase this parameter in 0.1-unit increments. If the setting value is too high, it can cause large speed or current ripples.
- If sudden increases in the regenerative load cause *ov* faults and *L3-11* = 1, gradually increase this parameter in 0.1-unit increments. If the setting value is too high, it can cause large speed or current ripples.

■ **L3-21: OVSUPPRESSION ACCEL/DECCEL P GAIN**

No. (Hex.)	Name	Description	Default (Range)
L3-21 (0466) Expert	OVSUPPRESSION ACCEL/DECCEL P GAIN	<input type="checkbox"/> Vf <input type="checkbox"/> CL-Vf <input type="checkbox"/> OLV <input type="checkbox"/> CLV <input type="checkbox"/> AOLV <input type="checkbox"/> OLV/PM <input type="checkbox"/> AOLV/PM <input type="checkbox"/> CLV/PM <input type="checkbox"/> EZOLV Sets the proportional gain to calculate acceleration and deceleration rates.	Determined by A1-02 (0.10 - 10.00)

Set one of these parameters to enable L3-21:

- *L2-29* = 1 [KEB Method Selection = Single Drive KEB Ride-Thru 2]
- *L3-04* = 2 [Decel Stall Prevention Selection = Automatic Decel Reduction]
- *L3-11* = 1 [OV SUPPRESSION FUNCTION SELECT = Enabled]
- *H1-xx* = 7A or 7B [MFDI Function Select = KEB Ride-Thru 2 (N.O./N.C.)]

**Note:**

- If stall prevention during deceleration function causes large speed or current ripples and *L2-29* = 1, *H1-xx* = 7A or 7B, or *L3-04* = 2, gradually decrease this parameter in 0.05-unit increments. If the drive detects *ov* [Overvoltage] or *oC* [Overcurrent], decrease this parameter. If you decrease the gain too much, it can cause a delay in control in the DC bus voltage or the deceleration time could be longer than the best deceleration time.
- If sudden increases in the regenerative load cause *ov* faults and *L3-11* = 1, gradually increase this parameter in 0.1-unit increments. If there are large speed ripples, gradually decrease this parameter in 0.05-unit increments.

■ **L3-22: PM STALL PREVENTION DECCEL TIME**

No. (Hex.)	Name	Description	Default (Range)
L3-22 (04F9)	PM STALL PREVENTION DECCEL TIME	<input type="checkbox"/> Vf <input type="checkbox"/> CL-Vf <input type="checkbox"/> OLV <input type="checkbox"/> CLV <input type="checkbox"/> AOLV <input checked="" type="checkbox"/> OLV/PM <input type="checkbox"/> AOLV/PM <input type="checkbox"/> CLV/PM <input type="checkbox"/> EZOLV Sets the momentary deceleration time that the drive will use when it tries to accelerate a PM motor and detected motor stalls. This function is applicable when <i>L3-01</i> = 1 [Stall Prevent Select during Accel = General Purpose].	0.0 s (0.0 - 6000.0 s)

Set this parameter to 0.0 s to disable this function. The drive will decelerates in the deceleration time applicable at the time when a motor stall occurs.

■ **L3-23: STALL P REDUCTION AT CONSTANT HP**

No. (Hex.)	Name	Description	Default (Range)
L3-23 (04FD)	STALL P REDUCTION AT CONSTANT HP	<input type="checkbox"/> Vf <input type="checkbox"/> CL-Vf <input type="checkbox"/> OLV <input type="checkbox"/> CLV <input type="checkbox"/> AOLV <input type="checkbox"/> OLV/PM <input type="checkbox"/> AOLV/PM <input type="checkbox"/> CLV/PM <input type="checkbox"/> EZOLV Sets the function to automatically decrease the Stall Prevention Level during Run for constant output ranges.	0 (0, 1)

**0 : Use L3-06 for Entire Speed Range**

The drive uses the level set in *L3-06* [Stall Prevent Level during Run] through the full speed range.

**1 : Automatic Reduction @ CHP Region**

The drive decreases the Stall Prevention level during run in the constant power range. The lower limit is 40% of the *L3-06* value.

■ **L3-24: MOTOR ACCEL TIME @ RATED TORQUE**

No. (Hex.)	Name	Description	Default (Range)
L3-24 (046E) Expert	MOTOR ACCEL TIME @ RATED TORQUE	<input type="checkbox"/> Vf <input type="checkbox"/> CL-Vf <input type="checkbox"/> OLV <input type="checkbox"/> CLV <input type="checkbox"/> AOLV <input type="checkbox"/> OLV/PM <input type="checkbox"/> AOLV/PM <input type="checkbox"/> CLV/PM <input type="checkbox"/> EZOLV Sets the motor acceleration time to reach the maximum frequency at the motor rated torque for stopped single-drive motors.	Determined by o2-04, C6-01, E2-11, and E5-01 (0.001 - 10.000 s)

Set one of these parameters to enable L3-24:

- L2-29 = 1 [KEB Method Selection = Single Drive KEB Ride-Thru 2]
- L3-04 = 2 [Decel Stall Prevention Selection = Automatic Decel Reduction]
- L3-11 = 1 [OV Suppression Function Select = Enabled]
- H1-xx = 7A or 7B [MFDI Function Select = KEB Ride-Thru 2 (N.O./N.C.)]

**Note:**

When Auto-Tuning changes the value of E2-11 [Motor Rated Power (kW)], the drive will automatically set this parameter to the value for a Yaskawa standard motor (4 poles). When you use a PM motor, the drive uses the value in E5-01 [PM Motor Code Selection] to change this parameter.

**Automatically Adjust Parameters**

Execute the Inertia Tuning process when A1-02 = 3 or 7 [Control Method Selection = Closed Loop Vector Control or PM Closed Loop Vector Control]. Parameters are automatically adjusted.

**Manually Adjust Parameters**

Use this formula to find the motor acceleration time:

$$L3-24 = \frac{2\pi \cdot J_{\text{Motor}} \cdot n_{\text{rated}}}{60 \cdot T_{\text{rated}}}$$

- J<sub>Motor</sub> = Moment of inertia of motor (kg m<sup>2</sup>)
- n<sub>rated</sub> = Motor rated speed (min<sup>-1</sup>, r/min)
- T<sub>rated</sub> = Motor rated torque (N·m)

The rated torque is calculated using the following expression.

$$T_{\text{rated}} = \frac{60 \cdot P_{\text{Motor}} \cdot 10^3}{2\pi \cdot n_{\text{rated}}}$$

P<sub>Motor</sub> = Motor Rated Power (kW)

■ **L3-25: Load Inertia Ratio**

No. (Hex.)	Name	Description	Default (Range)
L3-25 (046F) Expert	Load Inertia Ratio	<div style="display: flex; gap: 5px;"> <span>V/f</span> <span>CL-V/f</span> <span>OLV</span> <span>CLV</span> <span>AOLV</span> <span>OLV/PM</span> <span>AOLV/PM</span> <span>CLV/PM</span> <span>EZOLV</span> </div> Sets the ratio between motor inertia and machine inertia.	1.0 (1.0 - 1000.0)

Set one of these parameters to enable L3-25:

- L2-29 = 1 [Kinetic Energy Backup Method = Single Drive KEB Ride-Thru 2]
- L3-04 = 2 [Stall Prevention during Decel = Intelligent (Ignore Decel Ramp)]
- L3-11 = 1 [Overvoltage Suppression Select = Enabled]
- H1-xx = 7A or 7B [MFDI Function Select = KEB Ride-Thru 2 Activate (N.C./N.O.)]

**Note:**

- If you set this value incorrectly when L2-29 = 1, H1-xx = 7A or 7B, or L3-11 = 1, it can cause large current ripples and ov [Overvoltage], Uv1 [DC Bus Undervoltage], or oC [Overcurrent] faults.
- KEB Tuning will automatically set this value.

**Automatically Adjust Parameters**

Do Inertia Tuning when A1-02 = 3 or 7 [Control Method Selection = Closed Loop Vector or PM Closed Loop Vector]. The drive will automatically adjust parameters.

**Manually Adjust Parameters**

Use this formula to find the load inertia ratio:

$$\text{Load inertia ratio} = \frac{\text{Machine inertia (Motor shaft conversion value)}}{\text{Motor inertia}}$$

■ **L3-26: Additional DC Bus Capacitors**

No. (Hex.)	Name	Description	Default (Range)
L3-26 (0455) Expert	Additional DC Bus Capacitors	<div style="display: flex; gap: 5px;"> <span>V/f</span> <span>CL-V/f</span> <span>OLV</span> <span>CLV</span> <span>AOLV</span> <span>OLV/PM</span> <span>AOLV/PM</span> <span>CLV/PM</span> <span>EZOLV</span> </div> Sets the capacity for external main circuit capacitors. Sets this parameter when you use the KEB Ride-Thru function. Usually it is not necessary to change this setting.	0 μF (0 to 65000 μF)

■ **L3-27: Stall Prevention Detection Time**

No. (Hex.)	Name	Description	Default (Range)
L3-27 (0456)	Stall Prevention Detection Time	<div style="display: flex; justify-content: space-between; font-size: 0.8em; font-weight: bold;"> <span>V/f</span> <span>CL-V/f</span> <span>OLV</span> <span>CLV</span> <span>AOLV</span> <span>OLV/PM</span> <span>AOLV/PM</span> <span>CLV/PM</span> <span>EZOLV</span> </div> <p>Sets a delay time between reaching the Stall Prevention level and starting the Stall Prevention function.</p>	50 ms (0 - 5000 ms)

■ **L3-34: Torque Limit Delay Time**

No. (Hex.)	Name	Description	Default (Range)
L3-34 (016F) Expert	Torque Limit Delay Time	<div style="display: flex; justify-content: space-between; font-size: 0.8em; font-weight: bold;"> <span>V/f</span> <span>CL-V/f</span> <span>OLV</span> <span>CLV</span> <span>AOLV</span> <span>OLV/PM</span> <span>AOLV/PM</span> <span>CLV/PM</span> <span>EZOLV</span> </div> <p>Sets the filter time constant that returns the torque limit to its initial value when KEB operation operates in Single Drive KEB Ride-Thru mode.</p>	Determined by A1-02 (0.000 - 1.000 s)

When vibration occurs during operation of Single Drive KEB Ride-Thru 2, increase this parameter in 0.010-unit increments.

**Note:**

The Single Drive KEB Ride-Thru 2 mode operates when  $L2-29 = 1$  [KEB Method Selection = Single Drive KEB Ride-Thru 2] and  $H1-xx = 7A$  or  $7B$  [Terminal Sx Function Selection = KEB Ride-Thru 2 (N.C./N.O.)].

■ **L3-35: Speed Agree Width for Auto Decel**

No. (Hex.)	Name	Description	Default (Range)
L3-35 (0747) Expert	Speed Agree Width for Auto Decel	<div style="display: flex; justify-content: space-between; font-size: 0.8em; font-weight: bold;"> <span>V/f</span> <span>CL-V/f</span> <span>OLV</span> <span>CLV</span> <span>AOLV</span> <span>OLV/PM</span> <span>AOLV/PM</span> <span>CLV/PM</span> <span>EZOLV</span> </div> <p>Sets the width for speed agreement when <math>L3-04 = 2</math> [Decel Stall Prevention Selection = Automatic Decel Reduction]. Usually it is not necessary to change this setting.</p>	0.00 Hz (0.00 - 1.00 Hz)

Set this parameter when hunting occurs while you use a frequency reference through an analog input.

■ **L3-36: Current Suppression Gain@Accel**

No. (Hex.)	Name	Description	Default (Range)
L3-36 (11D0)	Current Suppression Gain@Accel	<div style="display: flex; justify-content: space-between; font-size: 0.8em; font-weight: bold;"> <span>V/f</span> <span>CL-V/f</span> <span>OLV</span> <span>CLV</span> <span>AOLV</span> <span>OLV/PM</span> <span>AOLV/PM</span> <span>CLV/PM</span> <span>EZOLV</span> </div> <p>Sets the gain to suppress current and motor speed hunting during operation when <math>L3-01 = 3</math> [Stall Prevention during Accel = Current Limit Method]. Usually it is not necessary to change this setting.</p>	Determined by A1-02 (0.0 - 100.0)

If there is vibration in the output current during acceleration, increase the setting value.

**Note:**

Set  $L3-01 = 3$  [Stall Prevention during Accel = Current Limit Method] to enable this function.

■ **L3-37: Current Limit P Gain @ Accel**

No. (Hex.)	Name	Description	Default (Range)
L3-37 (11D1) Expert	Current Limit P Gain @ Accel	<div style="display: flex; justify-content: space-between; font-size: 0.8em; font-weight: bold;"> <span>V/f</span> <span>CL-V/f</span> <span>OLV</span> <span>CLV</span> <span>AOLV</span> <span>OLV/PM</span> <span>AOLV/PM</span> <span>CLV/PM</span> <span>EZOLV</span> </div> <p>Usually it is not necessary to change this setting.</p>	5 ms (0 - 100 ms)

**Note:**

Set  $L3-01 = 3$  [Stall Prevent Limit during Accel = ILim Mode] to enable this function.

■ **L3-38: Current Limit I Time @ Accel**

No. (Hex.)	Name	Description	Default (Range)
L3-38 (11D2) Expert	Current Limit I Time @ Accel	<div style="display: flex; justify-content: space-between; font-size: 0.8em; font-weight: bold;"> <span>V/f</span> <span>CL-V/f</span> <span>OLV</span> <span>CLV</span> <span>AOLV</span> <span>OLV/PM</span> <span>AOLV/PM</span> <span>CLV/PM</span> <span>EZOLV</span> </div> <p>Suppresses current hunting and overshooting that occurs when the drive stalls during acceleration. Usually it is not necessary to change this setting.</p>	10.0 (0.0 - 100.0)

**Note:**

Set  $L3-01 = 3$  [*Stall Prevent Limit during Accel = ILim Mode*] to enable this function.

### ■ L3-39: Current Limit Filter Time @Accel

No. (Hex.)	Name	Description	Default (Range)
L3-39 (11D3)	Current Limit Filter Time @Accel	<div style="display: flex; justify-content: space-between; font-size: 0.8em; font-weight: bold;"> <span>V/f</span> <span>CL-V/f</span> <span>OLV</span> <span>CLV</span> <span>AOLV</span> <span>OLV/PM</span> <span>AOLV/PM</span> <span>CLV/PM</span> <span>EZOLV</span> </div> <p>Sets the time constant to adjust the acceleration rate when <math>L3-01 = 3</math> [<i>Stall Prevention during Accel = Current Limit Method</i>]. Usually it is not necessary to change this setting.</p>	100.0 ms (1.0 - 1000.0 ms)

**Note:**

Set  $L3-01 = 3$  [*Stall Prevention during Accel = Current Limit Method*] to enable this function.

### ■ L3-40: Current Limit S-Curve @ Acc/Dec

No. (Hex.)	Name	Description	Default (Range)
L3-40 (11D4)	Current Limit S-Curve @ Acc/Dec	<div style="display: flex; justify-content: space-between; font-size: 0.8em; font-weight: bold;"> <span>V/f</span> <span>CL-V/f</span> <span>OLV</span> <span>CLV</span> <span>AOLV</span> <span>OLV/PM</span> <span>AOLV/PM</span> <span>CLV/PM</span> <span>EZOLV</span> </div> <p>Sets the function to enable and disable the best S-curve characteristic used for current-limited acceleration.</p>	0 (0, 1)

Makes the best motor acceleration rate for start up. If you set this parameter to 1, it will make acceleration more stable, but it can also increase the acceleration time to be longer than the set time. If the drive detects *oC* [*Overcurrent*] faults immediately after acceleration starts, set this parameter.

**0 : Disabled**

**1 : Enabled**

**Note:**

Set  $L3-01 = 3$  [*Stall Prevention during Accel = Current Limit Method*] to enable this function.

## ◆ L4: Speed Detection

*L4 parameters* set the output of signals to the MFDO terminals, for example frequency agree and speed detection. The drive detects motor speed in CLV or CLV/PM control methods.

### ■ L4-01: Speed Agree Detection Level

No. (Hex.)	Name	Description	Default (Range)
L4-01 (0499)	Speed Agree Detection Level	<div style="display: flex; justify-content: space-between; font-size: 0.8em; font-weight: bold;"> <span>V/f</span> <span>CL-V/f</span> <span>OLV</span> <span>CLV</span> <span>AOLV</span> <span>OLV/PM</span> <span>AOLV/PM</span> <span>CLV/PM</span> <span>EZOLV</span> </div> <p>Sets the level to detect speed agree or motor speed.</p>	Determined by A1-02 (Determined by A1-02)

Sets the level to detect speed agree or motor speed when  $H2-01$  to  $H2-03 = 2, 3, 4, 5$  [*MFDO Function Select = Speed Agree 1, User-set Speed Agree 1, Frequency Detection 1, Frequency Detection 2*].

### ■ L4-02: Speed Agree Detection Width

No. (Hex.)	Name	Description	Default (Range)
L4-02 (049A)	Speed Agree Detection Width	<div style="display: flex; justify-content: space-between; font-size: 0.8em; font-weight: bold;"> <span>V/f</span> <span>CL-V/f</span> <span>OLV</span> <span>CLV</span> <span>AOLV</span> <span>OLV/PM</span> <span>AOLV/PM</span> <span>CLV/PM</span> <span>EZOLV</span> </div> <p>Sets the width to detect speed agree or motor speed.</p>	Determined by A1-02 (Determined by A1-02)

Sets the width to detect speed agree or motor speed when  $H2-01$  to  $H2-03 = 2, 3, 4, 5$  [*MFDO Function Select = Speed Agree 1, User-set Speed Agree 1, Frequency Detection 1, Frequency Detection 2*].

■ **L4-03: Speed Agree Detection Level(+/-)**

No. (Hex.)	Name	Description	Default (Range)
L4-03 (049B)	Speed Agree Detection Level(+/-)	<b>V/f</b> <b>CL-V/f</b> <b>OLV</b> <b>CLV</b> <b>AOLV</b> <b>OLV/PM</b> <b>AOLV/PM</b> <b>CLV/PM</b> <b>EZOLV</b> Sets the level to detect speed agree or motor speed.	Determined by A1-02 (Determined by A1-02)

Sets the level to detect speed agree or motor speed when H2-01 to H2-03 = 13, 14, 15, 16 [MFDO Function Select = Speed Agree 2, User-set Speed Agree 2, Frequency Detection 3, Frequency Detection 4].

■ **L4-04: Speed Agree Detection Width(+/-)**

No. (Hex.)	Name	Description	Default (Range)
L4-04 (049C)	Speed Agree Detection Width(+/-)	<b>V/f</b> <b>CL-V/f</b> <b>OLV</b> <b>CLV</b> <b>AOLV</b> <b>OLV/PM</b> <b>AOLV/PM</b> <b>CLV/PM</b> <b>EZOLV</b> Sets the width to detect speed agree or motor speed.	Determined by A1-02 (Determined by A1-02)

Sets the width to detect speed agree or motor speed when H2-01 to H2-03 = 13, 14, 15, 16 [MFDO Function Select = Speed Agree 2, User-set Speed Agree 2, Frequency Detection 3, Frequency Detection 4].

■ **L4-05: Fref Loss Detection Selection**

No. (Hex.)	Name	Description	Default (Range)
L4-05 (049D)	Fref Loss Detection Selection	<b>V/f</b> <b>CL-V/f</b> <b>OLV</b> <b>CLV</b> <b>AOLV</b> <b>OLV/PM</b> <b>AOLV/PM</b> <b>CLV/PM</b> <b>EZOLV</b> Sets the operation when the drive detects a loss of frequency reference.	0 (0, 1)

Enables the detection of a loss of an analog frequency reference when the frequency reference is input from the MFAI terminals (A1, A2, and A3). Set H2-01 to H2-03 = C [MFDO Function Select = Frequency Reference Loss] to enable this function.

If the frequency reference is less than 10% in 400 ms, the drive detects frequency reference loss.

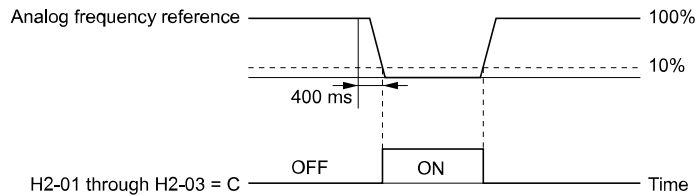


Figure 11.140 Detection of Frequency Reference Loss

**0 : Stop**

The drive follows the frequency reference and stops the motor.

**1 : Run at (L4-06 x Last Reference)**

The drive continues to operate at the frequency reference value set in L4-06 [FreqReference at Reference Loss]. When you return the external frequency reference value, the drive continues to operate with the frequency reference.

■ **L4-06: Frequency Reference @Loss of Ref**

No. (Hex.)	Name	Description	Default (Range)
L4-06 (04C2)	Frequency Reference @Loss of Ref	<b>V/f</b> <b>CL-V/f</b> <b>OLV</b> <b>CLV</b> <b>AOLV</b> <b>OLV/PM</b> <b>AOLV/PM</b> <b>CLV/PM</b> <b>EZOLV</b> Sets the frequency reference as a percentage to continue drive operation after it detects a frequency reference loss. The value is a percentage of the frequency reference before the drive detected the loss.	80.0% (0.0 - 100.0%)

Set L4-05 = 1 [FreqReference Loss Detect Select = Run@L4-06PrevRef] to enable this parameter.

## ■ L4-07: Speed Agree Detection Selection

No. (Hex.)	Name	Description	Default (Range)
L4-07 (0470)	Speed Agree Detection Selection	<b>V/f</b> <b>CL-V/f</b> <b>OLV</b> <b>CLV</b> <b>AOLV</b> <b>OLV/PM</b> <b>AOLV/PM</b> <b>CLV/PM</b> <b>EZOLV</b> Sets the condition that activates speed detection.	0 (0, 1)

### 0 : No Detection during Baseblock

Detects the frequency while the drive is operating. When the drive turns off its output, it will not detect frequency.

### 1 : Detection Always Enabled

## ◆ L5: Fault Restart

The Auto Restart function tries to keep machines operating when the drive detects a transient fault.

The drive can do a self-diagnostic check and continue the operation after a fault has occurred. If the cause of the fault goes away, the drive does speed search and restarts. It will not stop and the drive will not record a fault history. Use L5-02 [Fault Contact at Restart Select] to select the operation of fault relay signals during Auto Restart operation.

Sets if the drive will do Auto Restart and the number of times the drive will try to do Auto Restart in a set time. If the number of Auto Restart tries is more than the set value during the set time, drive output shuts off and operation stops. If this happens, remove the cause of the fault and manually restart the drive.

**DANGER!** Sudden Movement Hazard. Failure to obey can cause death or serious injury. Do not use the fault restart function in hoist or lifting applications.

The drive can do Auto Restart when these faults occur:

#### Note:

You can disable Auto Restart for faults if you must not restart the machine after the fault.

Table 11.73 List of Faults during which Auto Restart is Available

Fault	Name	Parameters to Disable Auto Restart	Fault	Name	Parameters to Disable Auto Restart
GF	Ground Fault	L5-08	ov	Overvoltage	L5-08
LF	Output Phase Loss	-	PF	Input Phase Loss	-
oC	Overcurrent	-	rH	Braking Resistor Overheat	-
oH1	Heatsink Overheat	L5-08	rr	Dynamic Braking Transistor Fault	-
oL1	Motor Overload	L5-07	STPo	Motor Step-Out Detected	-
oL2	Drive Overload	L5-07	Uv1	DC Bus Undervoltage *1	L5-08
oL3	Overtorque Detection 1	L5-07			
oL4	Overtorque Detection 2	L5-07			

\*1 Uv1 is the target for the auto restart process when L2-01 = 1, 2, 3, or 4 [Power Loss Ride Through Select = Enabled for L2-02 Time, Enabled while CPU Power Active, Kinetic Energy Backup: L2-02, or Kinetic Energy Backup: CPU Power].

## ■ L5-01: Number of Auto-Restart Attempts

No. (Hex.)	Name	Description	Default (Range)
L5-01 (049E)	Number of Auto-Restart Attempts	<b>V/f</b> <b>CL-V/f</b> <b>OLV</b> <b>CLV</b> <b>AOLV</b> <b>OLV/PM</b> <b>AOLV/PM</b> <b>CLV/PM</b> <b>EZOLV</b> Sets the number of times that the drive will try to restart.	0 (0 - 10 times)

The drive resets the number of Auto Restart attempts to 0 in these conditions:

- The drive operates correctly for 10 minutes after a fault restart.
- When you manually clear a fault after the drive triggers protective functions.
- When you re-energize the drive.

■ **L5-02: Fault Contact at Restart Select**

No. (Hex.)	Name	Description	Default (Range)
L5-02 (049F)	Fault Contact at Restart Select	<b>V/f</b> <b>CL-V/f</b> <b>OLV</b> <b>CLV</b> <b>AOLV</b> <b>OLV/PM</b> <b>AOLV/PM</b> <b>CLV/PM</b> <b>EZOLV</b> Sets the function that sends signals to the MFDO terminal set for <i>Fault [H2-xx = E]</i> while the drive is automatically restarting.	0 (0, 1)

**0 : Active Only when Not Restarting**

**1 : Always Active**

■ **L5-04: Interval Method Restart Time**

No. (Hex.)	Name	Description	Default (Range)
L5-04 (046C)	Interval Method Restart Time	<b>V/f</b> <b>CL-V/f</b> <b>OLV</b> <b>CLV</b> <b>AOLV</b> <b>OLV/PM</b> <b>AOLV/PM</b> <b>CLV/PM</b> <b>EZOLV</b> Sets the time interval between each Auto Restart attempt. Set <i>L5-05 = 1</i> [ <i>Auto-Restart Method = Continuous/Immediate Attempts</i> ] to enable this function.	10.0 s (0.5 - 600.0 s)

■ **L5-05: Auto-Restart Method**

No. (Hex.)	Name	Description	Default (Range)
L5-05 (0467)	Auto-Restart Method	<b>V/f</b> <b>CL-V/f</b> <b>OLV</b> <b>CLV</b> <b>AOLV</b> <b>OLV/PM</b> <b>AOLV/PM</b> <b>CLV/PM</b> <b>EZOLV</b> Sets the count method for the Auto Restart operation.	0 (0, 1)

**0 : Continuous/Immediate Attempts**

Counts the number of successful fault resets through Auto Restart.

When this value > *L5-01*, the drive will send a fault signal and fault code to the keypad and the motor will coast to stop.

**1 : Interval/Attempt after L5-04 sec**

Counts the number of successful and unsuccessful fault resets through Auto Restart. The drive does the Auto Restart process again in the intervals set in *L5-04* [*Interval Method Restart Time*].

When this value > *L5-01*, the drive will send a fault signal and fault code to the keypad and the motor will coast to stop.

■ **L5-07: Fault Reset Enable Select Grp1**

No. (Hex.)	Name	Description	Default (Range)
L5-07 (0B2A)	Fault Reset Enable Select Grp1	<b>V/f</b> <b>CL-V/f</b> <b>OLV</b> <b>CLV</b> <b>AOLV</b> <b>OLV/PM</b> <b>AOLV/PM</b> <b>CLV/PM</b> <b>EZOLV</b> Use these 4 digits to set the Auto Restart function for <i>oL1</i> to <i>oL4</i> . From left to right, the digits set <i>oL1</i> , <i>oL2</i> , <i>oL3</i> , and <i>oL4</i> , in order.	1111 (0000 - 1111)

**0 : Disabled**

**1 : Enabled(—/—/—/—/oL4)**

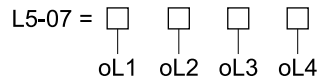


Figure 11.141 Setting Digits and Fault Code

■ **L5-08: Fault Reset Enable Select Grp2**

No. (Hex.)	Name	Description	Default (Range)
L5-08 (0B2B)	Fault Reset Enable Select Grp2	<b>V/f</b> <b>CL-V/f</b> <b>OLV</b> <b>CLV</b> <b>AOLV</b> <b>OLV/PM</b> <b>AOLV/PM</b> <b>CLV/PM</b> <b>EZOLV</b> Use these 4 digits to set the Auto Restart function for <i>Uv1</i> , <i>ov</i> , <i>oH1</i> , and <i>GF</i> . From left to right, the digits set <i>Uv1</i> , <i>ov</i> , <i>oH1</i> , and <i>GF</i> , in order.	1111 (0000 - 1111)

**0 : Disabled**

**1 : Enabled(—/—/—/—/GF)**



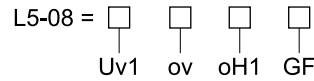


Figure 11.142 Setting Digits and Fault Code

## ◆ L6: Torque Detection

The overtorque/undertorque detection function prevents damage to machinery and loads.

Overtorque is the when there is too much load on the machine. If the motor current or output torque is at the overtorque detection level for the overtorque detection time, the drive will output an alarm and turn off the output.

Undertorque is the when a load suddenly decreases. When the motor current or output torque is at the undertorque detection level for the undertorque detection time, the drive will output an alarm and turn off the output.

You can use the undertorque detection function to detect these conditions, for example:

- Machine belt cuts
- Unusual operation of the electromagnetic contactor on the drive output side
- Clogged output side air filters in fans and blowers
- Damage to blade tips and broken string

### Note:

If there is *oC* [Overcurrent] or *oLI* [Motor Overload], the drive can stop during overtorque conditions. Use torque detection to identify overload conditions before the drive detects *oC* or *oLI* and stops. Use this function to detect issues that occur in the application.

## ■ Parameter Settings

You can individually set the two overtorque/undertorque detection functions with the drive. Use the information in Table 11.74 to set the parameters.

Table 11.74 Overtorque/Undertorque Detection Parameters

Configuration Parameter	Overtorque/Undertorque Detection 1	Overtorque/Undertorque Detection 2
MFDO Function Select	H2-01, H2-02, and H2-03 = B N.O.: Activated when detected	H2-01, H2-02, and H2-03 = 18 N.O.: Activated when detected
<ul style="list-style-type: none"> <li>• Terminals M1-M2</li> <li>• Terminals M3-M4</li> <li>• Terminals M5-M6</li> </ul>	H2-01, H2-02, and H2-03 = 17 N.C.: Disactivated when detected	H2-01, H2-02, and H2-03 = 19 N.C.: Disactivated when detected
Detection conditions and selection of operation after detection	L6-01	L6-04
Detection Level	L6-02	L6-05
	Analog Input Terminal *1 H3-xx = 7	-
Detection Time	L6-03	L6-06

\*1 An analog input terminal can also supply the torque detection level. Set *H3-xx = 7* [MFAI Function Select = Overtorque/Undertorque DetectLvl] to enable this function. If *L6-02* and *H3-xx = 7*, the analog input is more important, and the drive disables *L6-02*.

You cannot use Overtorque/Undertorque Detection 2 to set the detection level for the analog input terminals.

### Note:

In V/f Control, the drive uses the current level (100% of the drive rated output current) to detect overtorque/undertorque. In vector control, the drive uses the motor torque (100% of the motor rated torque) to detect overtorque/undertorque. When you enable the mechanical weakening detection function, the overtorque/undertorque detection level for all control modes is the current level (100% of the drive rated output current).

## ■ Time Chart for Detection of Overtorque/Undertorque

### Overtorque Detection Time Chart

When you use Overtorque/Undertorque Detection 1, the drive detects overtorque if the motor current or motor torque is at the detection level set in *L6-02* [Torque Detection Level 1] for the set in *L6-03* [Torque Detection Time 1]. Parameter *L6-01* [Torque Detection Selection 1] sets the operation after detection.

When you use Overtorque/Undertorque Detection 2, set *L6-05* [Torque Detection Level 2], *L6-06* [Torque Detection Time 2], and *L6-04* [Torque Detection Selection 2].

Set the terminal that outputs the alarm in *H2-01* to *H2-03* [MFDO Function Select].

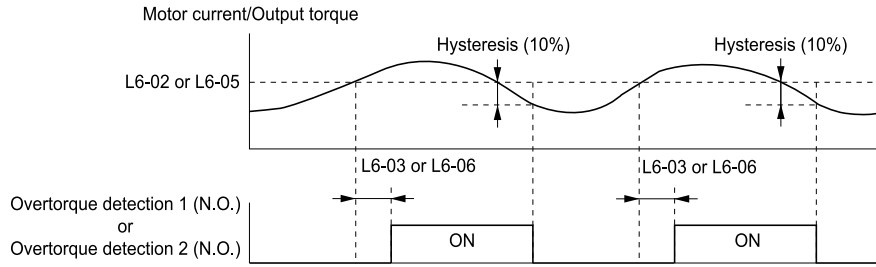


Figure 11.143 Overtorque Detection Time Chart

**Note:**

The drive applies a hysteresis of approximately 10% of the drive rated output current or the motor rated torque to the overtorque/undertorque detection function.

**Undertorque Detection Time Chart**

When you use Overtorque/Undertorque Detection 1, the drive detects undertorque if the motor current or motor torque is less than or equal to the detection level set in L6-02 for the time set in L6-03.

Parameter L6-01 sets the operation after detection. When you use Overtorque/Undertorque Detection 2, set the operation in L6-05, L6-06, and L6-04.

Set the terminal that outputs an alarm in H2-01 to H2-03.

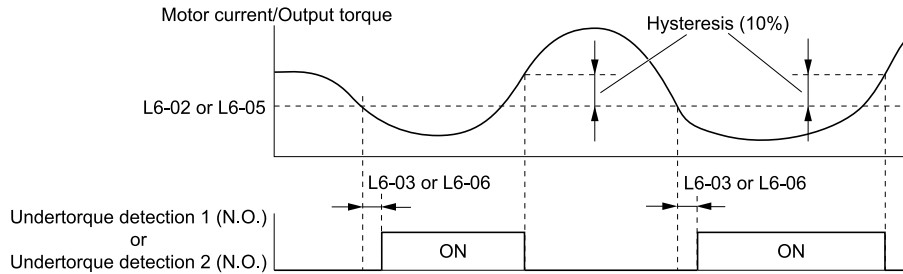


Figure 11.144 Undertorque Detection Time Chart

**Note:**

The drive applies a hysteresis of approximately 10% of the drive rated output current or the motor rated torque to the overtorque/undertorque detection function.

**■ Mechanical Weakening Detection**

The Mechanical Weakening Detection function detects the mechanical weakening of a machine that can cause overtorque or undertorque because of motor speed and total drive operation time.

The drive activates the function if the drive total operation time is longer than the time set in L6-11 [Mech Fatigue Hold Off Time]. You can use U4-01 [Cumulative Ope Time] to monitor the total operation time.

**Parameter Settings**

The drive detects Mechanical Weakening if overtorque or undertorque occur during the speed range set in L6-08 [Mechanical Fatigue Detect Select] and L6-09 [Mech Fatigue Detect Speed Level] for the length of time set in L6-10 [Mech Fatigue Detect Delay Time]. The drive uses L6-01 to L6-03 [Torque Detection 1 Setting Parameter] to detect oL5 [Mechanical Weakening Detection 1] or UL5 [Mechanical Weakening Detection 2]. Parameter L6-08 sets the operation after detection.










Set the terminal that outputs the fault in H2-01 to H2-03 [MFDO Function Select].

Table 11.75 Mechanical Weakening Detection Settings Parameters

Configuration Parameter	Mechanical Deterioration Detection
MFDO Function Select • Terminals M1-M2 • Terminals M3-M4 • Terminals M5-M6	H2-01, H2-02, and H2-03 = 22
Operation Selection after Detection	L6-08
Detection Start Time	L6-11

Configuration Parameter		Mechanical Deterioration Detection
Speed Range	Detection Criteria	L6-08
	Detection Level	L6-09
	Detection Time	L6-10
Overtorque	Detection Criteria	L6-01
	Detection Level	L6-02
	Detection Time	L6-03

### ■ L6-01: Torque Detection Selection 1

No. (Hex.)	Name	Description	Default (Range)
L6-01 (04A1)	Torque Detection Selection 1	         Sets the speed range that detects overtorque and undertorque and the operation of drives (operation status) after detection.	0 (0 - 8)

The drive detects overtorque if the motor current or output torque is more than the level set in *L6-02 [Torque Detection Level 1]* for the length of time set in *L6-03 [Torque Detection Time 1]*. The drive detects undertorque if the motor current or output torque is less than the level set in *L6-02* for the length the time set in *L6-03*.

#### 0 : Disabled

The drive will not detect overtorque or undertorque.

#### 1 : oL @ Speed Agree - Alarm only

The drive detects overtorque when the output frequency aligns with the frequency reference. Detection does not occur during acceleration/deceleration. The drive outputs an *oL3 [Overtorque Detection 1]* and operation continues.

#### 2 : oL @ RUN - Alarm only

When the Run command is enabled, the drive constantly detects overtorque. The drive outputs an *oL3* and operation continues.

#### 3 : oL @ Speed Agree - Fault

The drive detects overtorque when the output frequency aligns with the frequency reference. Detection does not occur during acceleration/deceleration. The drive outputs an *oL3 [Overtorque Detection 1]* and operation stops.

#### 4 : oL @ RUN - Fault

When the Run command is enabled, the drive constantly detects overtorque. The drive outputs an *oL3* and operation stops.

#### 5 : UL @ Speed Agree - Alarm only

The drive detects undertorque when the output frequency aligns with the frequency reference. Detection does not occur during acceleration/deceleration. The drive outputs a *UL3 [Undertorque Detection 1]* and operation continues.

#### 6 : UL @ RUN - Alarm only

When the Run command is enabled, the drive constantly detects undertorque. The drive outputs a *UL3* and operation continues.

#### 7 : UL @ Speed Agree - Fault

The drive detects undertorque when the output frequency aligns with the frequency reference. Detection does not occur during acceleration/deceleration. The drive outputs a *UL3* and operation stops.

#### 8 : UL @ RUN - Fault

When the Run command is enabled, the drive constantly detects undertorque. The drive outputs a *UL3* and operation stops.

### ■ L6-02: Torque Detection Level 1

No. (Hex.)	Name	Description	Default (Range)
L6-02 (04A2)	Torque Detection Level 1	<div style="display: flex; justify-content: space-between; font-size: 0.8em; font-weight: bold; margin-bottom: 5px;"> <span>V/f</span> <span>CL-V/f</span> <span>OLV</span> <span>CLV</span> <span>AOLV</span> <span>OLV/PM</span> <span>AOLV/PM</span> <span>CLV/PM</span> <span>EZOLV</span> </div> Sets the detection level for Overtorque/Undertorque Detection 1. In V/f control, drive rated output current = 100% value. In vector control, motor rated torque = 100% value.	150% (0 - 300%)

**Note:**

- Set the torque detection level as a percentage of the drive rated output current in all control methods to set the mechanical weakening detection level.
- You can also use an analog input terminal to supply the torque detection level. To enable this function, set  $H3-xx = 7$  [MFAI Function Select = Overtorque/Undertorque DetectLvl]. If you set L6-02 and  $H3-x = 7$ , the analog input is most important and the drive disables L6-02.

### ■ L6-03: Torque Detection Time 1

No. (Hex.)	Name	Description	Default (Range)
L6-03 (04A3)	Torque Detection Time 1	<div style="display: flex; justify-content: space-between; font-size: 0.8em; font-weight: bold; margin-bottom: 5px;"> <span>V/f</span> <span>CL-V/f</span> <span>OLV</span> <span>CLV</span> <span>AOLV</span> <span>OLV/PM</span> <span>AOLV/PM</span> <span>CLV/PM</span> <span>EZOLV</span> </div> Sets the detection time for Overtorque/Undertorque Detection 1.	0.1 s (0.0 - 10.0 s)

### ■ L6-04: Torque Detection Selection 2

No. (Hex.)	Name	Description	Default (Range)
L6-04 (04A4)	Torque Detection Selection 2	<div style="display: flex; justify-content: space-between; font-size: 0.8em; font-weight: bold; margin-bottom: 5px;"> <span>V/f</span> <span>CL-V/f</span> <span>OLV</span> <span>CLV</span> <span>AOLV</span> <span>OLV/PM</span> <span>AOLV/PM</span> <span>CLV/PM</span> <span>EZOLV</span> </div> Sets the speed range that detects overtorque and undertorque and the operation of drives (operation status) after detection.	0 (0 - 8)

The drive detects overtorque if the motor current or output torque is more than the level set in L6-05 [Torque Detection Level 2] for the length of time set in L6-06 [Torque Detection Time 2]. The drive detects undertorque if the motor current or output torque is less than the level set in L6-05 for the length the time set in L6-06.

#### 0 : Disabled

The drive will not detect overtorque or undertorque.

#### 1 : oL @ Speed Agree - Alarm only

The drive detects overtorque when the output frequency aligns with the frequency reference. Detection does not occur during acceleration/deceleration. The drive outputs an oL4 [Overtorque Detection 2] and operation continues.

#### 2 : oL @ RUN - Alarm only

When the Run command is enabled, the drive constantly detects overtorque. The drive outputs an oL4 and operation continues.

#### 3 : oL @ Speed Agree - Fault

The drive detects overtorque when the output frequency aligns with the frequency reference. Detection does not occur during acceleration/deceleration. The drive outputs an oL4 [Overtorque Detection 2] and operation stops.

#### 4 : oL @ RUN - Fault

When the Run command is enabled, the drive constantly detects overtorque. The drive outputs an oL4 and operation stops.

#### 5 : UL @ Speed Agree - Alarm only

The drive detects undertorque when the output frequency aligns with the frequency reference. Detection does not occur during acceleration/deceleration. The drive outputs a UL4 [Undertorque Detection 2] and operation continues.

#### 6 : UL @ RUN - Alarm only

When the Run command is enabled, the drive constantly detects undertorque. The drive outputs a UL4 and operation continues.

#### 7 : UL @ Speed Agree - Fault

The drive detects undertorque when the output frequency aligns with the frequency reference. Detection does not occur during acceleration/deceleration. The drive outputs a UL4 and operation stops.

## 8 : UL @ RUN - Fault

When the Run command is enabled, the drive constantly detects undertorque. The drive outputs a *UL4* and operation stops

### ■ L6-05: Torque Detection Level 2

No. (Hex.)	Name	Description	Default (Range)
L6-05 (04A5)	Torque Detection Level 2	<div style="display: flex; justify-content: space-between; align-items: center;"> <span><b>V/f</b></span> <span><b>CL-V/f</b></span> <span><b>OLV</b></span> <span><b>CLV</b></span> <span><b>AOLV</b></span> <span><b>OLV/PM</b></span> <span><b>AOLV/PM</b></span> <span><b>CLV/PM</b></span> <span><b>EZOLV</b></span> </div> <p>Sets the detection level for Overtorque/Undertorque Detection 2. In V/f control, drive rated output current = 100% value. In vector control, motor rated torque = 100% value.</p>	150% (0 - 300%)

**Note:**

Overtorque/Undertorque Detection 2 cannot set the detection level for the analog input terminal.

### ■ L6-06: Torque Detection Time 2

No. (Hex.)	Name	Description	Default (Range)
L6-06 (04A6)	Torque Detection Time 2	<div style="display: flex; justify-content: space-between; align-items: center;"> <span><b>V/f</b></span> <span><b>CL-V/f</b></span> <span><b>OLV</b></span> <span><b>CLV</b></span> <span><b>AOLV</b></span> <span><b>OLV/PM</b></span> <span><b>AOLV/PM</b></span> <span><b>CLV/PM</b></span> <span><b>EZOLV</b></span> </div> <p>Sets the detection time for Overtorque/Undertorque Detection 2.</p>	0.1 s (0.0 - 10.0 s)

### ■ L6-07: Torque Detection Filter Time

No. (Hex.)	Name	Description	Default (Range)
L6-07 (04E5)	Torque Detection Filter Time	<div style="display: flex; justify-content: space-between; align-items: center;"> <span><b>V/f</b></span> <span><b>CL-V/f</b></span> <span><b>OLV</b></span> <span><b>CLV</b></span> <span><b>AOLV</b></span> <span><b>OLV/PM</b></span> <span><b>AOLV/PM</b></span> <span><b>CLV/PM</b></span> <span><b>EZOLV</b></span> </div> <p>Sets the time constant for a primary filter to the torque reference or to the output current used to detect overtorque/undertorque.</p>	0 ms (0 - 1000 ms)

### ■ L6-08: Mechanical Fatigue Detect Select

No. (Hex.)	Name	Description	Default (Range)
L6-08 (0468)	Mechanical Fatigue Detect Select	<div style="display: flex; justify-content: space-between; align-items: center;"> <span><b>V/f</b></span> <span><b>CL-V/f</b></span> <span><b>OLV</b></span> <span><b>CLV</b></span> <span><b>AOLV</b></span> <span><b>OLV/PM</b></span> <span><b>AOLV/PM</b></span> <span><b>CLV/PM</b></span> <span><b>EZOLV</b></span> </div> <p>Sets the speed where the drive detects mechanical deterioration and how the drive operates (operation status) after detection.</p>	0 (0 - 8)

The drive detects mechanical weakening through overtorque or undertorque as specified by the conditions set in *L6-08 to L6-11 [Mechanical Deterioration Detection Settings Parameters]*. Set overtorque/undertorque detection conditions in *L6-01 to L6-03 [Torque Detection 1 Settings Parameters]*. The drive disables the operation selection set in *L6-01 [Torque Detection Selection 1]*.

#### 0 : Disabled

The drive does not detect mechanical weakening.

#### 1 : oL5 @ Speed > L6-09 - Alarm

When the speed (signed)  $\geq$  *L6-09 [Mech Fatigue Detect Speed Level]*, the drive detects mechanical weakening. The drive will detect *oL5 [Mechanical Weakening Detection 1]* and continue operation.

#### 2 : oL5 @ ISpeed1 > L6-09 - Alarm

When the speed (absolute value)  $\geq$  *L6-09*, the drive detects mechanical weakening. The drive will detect *oL5* and continue operation.

#### 3 : oL5 @ Speed > L6-09 - Fault

When the speed (signed)  $\geq$  *L6-09*, the drive detects mechanical weakening. The drive will detect *oL5* and stop operation.

#### 4 : oL5 @ ISpeed1 > L6-09 - Fault

When the speed (absolute value)  $\geq$  *L6-09*, the drive detects mechanical weakening. The drive will detect *oL5* and stop operation.

#### 5 : UL5 @ Speed < L6-09 - Alarm

When the speed (signed)  $\leq$  *L6-09*, the drive detects mechanical weakening. The drive will detect *UL5 [Mechanical Weakening Detection 2]* and continue operation.

**6 : UL5 @ ISpeedI < L6-09 - Alarm**

When the speed (absolute value)  $\leq L6-09$ , the drive detects mechanical weakening. The drive will detect *UL5* and continue operation.

**7 : UL5 @ Speed < L6-09 - Fault**

When the speed (signed)  $\leq L6-09$ , the drive detects mechanical weakening. The drive will detect *UL5* and stop operation.

**8 : UL5 @ ISpeedI < L6-09 - Fault**

When the speed (absolute value)  $\leq L6-09$ , the drive detects mechanical weakening. The drive will detect *UL5* and stop operation.

**■ L6-09: Mech Fatigue Detect Speed Level**

No. (Hex.)	Name	Description	Default (Range)
L6-09 (0469)	Mech Fatigue Detect Speed Level	<b>V/f</b> <b>CL-V/f</b> <b>OLV</b> <b>CLV</b> <b>AOLV</b> <b>OLV/PM</b> <b>AOLV/PM</b> <b>CLV/PM</b> <b>EZOLV</b> Sets the speed level as a percentage where the drive will operate the mechanical deterioration detection function, with <i>E1-04 [Maximum Output Frequency]</i> is the 100% value.	110.0% (-110.0 - +110.0%)

Parameters *L6-01 to L6-03 [Torque Detection 1 Settings Parameters]* set the overtorque/undertorque detection conditions.

When *L6-08 = 2, 4, 6, 8 [Mechanical Fatigue Detect Select = Speed : unsigned]*, the setting value of *L6-09* is the absolute value. When *L6-09* is set to a negative number, the drive processes this value as a positive number.

**■ L6-10: Mech Fatigue Detect Delay Time**

No. (Hex.)	Name	Description	Default (Range)
L6-10 (046A)	Mech Fatigue Detect Delay Time	<b>V/f</b> <b>CL-V/f</b> <b>OLV</b> <b>CLV</b> <b>AOLV</b> <b>OLV/PM</b> <b>AOLV/PM</b> <b>CLV/PM</b> <b>EZOLV</b> Sets the time for mechanical deterioration detection.	0.1 s (0.0 - 10.0 s)

When the detection conditions set in *L6-08 [Mechanical Weakening Detect Ope]* continue for the time set in *L6-10*, the drive will detect mechanical weakening.

**■ L6-11: Mech Fatigue Hold Off Time**

No. (Hex.)	Name	Description	Default (Range)
L6-11 (046B)	Mech Fatigue Hold Off Time	<b>V/f</b> <b>CL-V/f</b> <b>OLV</b> <b>CLV</b> <b>AOLV</b> <b>OLV/PM</b> <b>AOLV/PM</b> <b>CLV/PM</b> <b>EZOLV</b> Sets the time that the drive will start mechanical deterioration detection triggered by the cumulative operation time of the drive.	0 h (0 - 65535 h)

When the total operation time of the drive is more than the value set in *L6-11*, the drive will detect mechanical weakening. Use *U4-01 [Cumulative Ope Time]* to monitor the drive total operation time.

**◆ L7: Torque Limit**

The torque limit function limits the internal torque reference for the drive to limit the quantity of torque generated by the motor to a constant quantity. This function keeps the torque applied to loads and regenerative torque less than a set quantity. This function also prevents damage to machinery and increases the reliability of continuous operation. You can set torque limits individually for the four quadrants, which include torque direction (motoring/regeneration) and direction of motor rotation (forward/reverse). When the torque reference value is at the set torque limit, the MFDO terminal set for During Torque Limit [*H2-xx = 30*] activates.

**Note:**

- The drive output current limits maximum output torque. The drive limits torque to 150% of the rated output current for Heavy Duty Rating (HD) and to 120% of the rated output current for Normal Duty Rating (ND). The actual output torque is not more than the limits of the drive rated output current when you set the torque limit to a high value.
- When you use torque limits for lifting applications, do not lower the torque limit value too much. When the torque limit function is triggered, falls and rollbacks can occur because of sudden acceleration stops and stalls of the motor.

**■ Configuring Settings**

Use one of these methods to set torque limits:

- Use L7-01 to L7-04 [Torque Limit] to individually set the four torque limit quadrants.
- Use MFAI to individually set the four torque limit quadrants. Set H3-02, H3-06, H3-10 = 10, 11, 12 [MFAI Function Select = Forward/Reverse/Regenerative Torque Limit].
- Use MFAI to set all four torque limit quadrants together. Set H3-02, H3-06, H3-10 = 15 [General Torque Limit].
- Use a communication option to set all four torque limit quadrants together.

Figure 11.145 shows the configuration method for each quadrant.

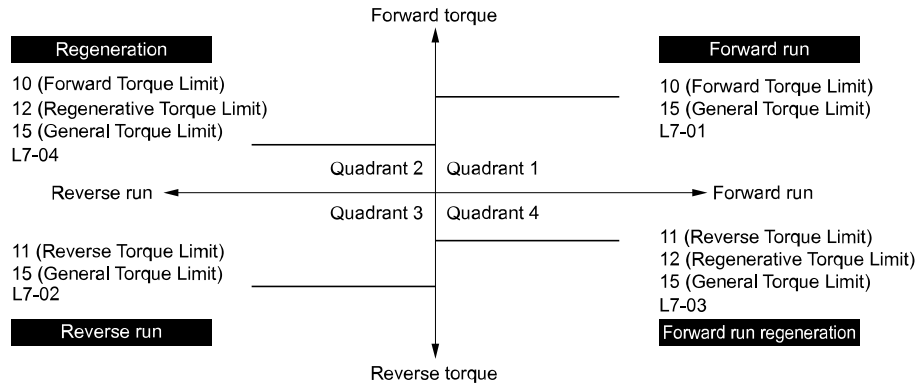


Figure 11.145 Torque Limits and Analog Input Setting Parameters

**Note:**

When L7-01 to L7-04 and analog inputs or communication option torque limits set torque limits for the same quadrant, the lower value is enabled.

In this example of parameter settings, the torque limit for quadrant 1 is 130% and the torque limit for quadrants 2, 3, and 4 is 150%.

Settings: L7-01 = 130%, L7-02, L7-03, L7-04 = 200%, MFAI torque limit = 150%

■ **L7-01: Forward Torque Limit**

No. (Hex.)	Name	Description	Default (Range)
L7-01 (04A7) RUN	Forward Torque Limit	<input type="checkbox"/> V/f <input type="checkbox"/> CL-V/f <input checked="" type="checkbox"/> OLV <input checked="" type="checkbox"/> CLV <input checked="" type="checkbox"/> AOLV <input type="checkbox"/> OLV/PM <input type="checkbox"/> AOLV/PM <input type="checkbox"/> CLV/PM <input type="checkbox"/> EZOLV Sets the torque limit value for forward motoring as a percentage, where motor rated torque is the 100% value.	200% (0 - 300%)

**Note:**

- The lower torque limit is enabled when you set the torque limit by the following method.
  - Set H3-02, H3-06, or H3-10 = 10, 15 [MFAI Function Select = Forward, Reverse/Regenerative Torque Limit].
  - Use a communication option to set the torque limits
- You must think about drive capacity when a large quantity of torque is necessary. If you set the value too high, the drive can detect oC [Overcurrent].
- If you set the value too low with large loads, the motor can stall.

■ **L7-02: Reverse Torque Limit**

No. (Hex.)	Name	Description	Default (Range)
L7-02 (04A8) RUN	Reverse Torque Limit	<input type="checkbox"/> V/f <input type="checkbox"/> CL-V/f <input checked="" type="checkbox"/> OLV <input checked="" type="checkbox"/> CLV <input checked="" type="checkbox"/> AOLV <input type="checkbox"/> OLV/PM <input type="checkbox"/> AOLV/PM <input type="checkbox"/> CLV/PM <input type="checkbox"/> EZOLV Sets the torque limit value for reversed motoring as a percentage, where motor rated torque is the 100% value.	200% (0 - 300%)

**Note:**

- The lower torque limit is enabled when you set the torque limit by the following method.
  - Set H3-02, H3-06, or H3-10 = 10, 15 [MFAI Function Select = Forward, Reverse/Regenerative Torque Limit].
  - Use a communication option to set the torque limits
- You must think about drive capacity when a large quantity of torque is necessary. If you set the value too high, the drive can detect oC [Overcurrent].
- If you set the value too low with large loads, the motor can stall.

### ■ L7-03: Forward Regenerative Trq Limit

No. (Hex.)	Name	Description	Default (Range)
L7-03 (04A9) RUN	Forward Regenerative Trq Limit	<input type="checkbox"/> V/f <input type="checkbox"/> CL-V/f <input checked="" type="checkbox"/> OLV <input type="checkbox"/> CLV <input type="checkbox"/> AOLV <input type="checkbox"/> OLV/PM <input type="checkbox"/> AOLV/PM <input type="checkbox"/> CLV/PM <input type="checkbox"/> EZOLV Sets the torque limit value for forward regenerative conditions as a percentage of the motor rated torque.	200% (0 - 300%)

**Note:**

- The lower torque limit is enabled when you set the torque limit by the following method.
  - Set H3-02, H3-06, or H3-10 = 10, 15 [MFAI Function Select = Forward, Reverse/Regenerative Torque Limit].
  - Use a communication option to set the torque limits
- You must think about drive capacity when a large quantity of torque is necessary. If you set the value too high, the drive can detect *oC* [Overcurrent].
- If you set the value too low with large loads, the motor can stall.

### ■ L7-04: Reverse Regenerative Trq Limit

No. (Hex.)	Name	Description	Default (Range)
L7-04 (04AA) RUN	Reverse Regenerative Trq Limit	<input type="checkbox"/> V/f <input type="checkbox"/> CL-V/f <input checked="" type="checkbox"/> OLV <input type="checkbox"/> CLV <input type="checkbox"/> AOLV <input type="checkbox"/> OLV/PM <input type="checkbox"/> AOLV/PM <input type="checkbox"/> CLV/PM <input type="checkbox"/> EZOLV Sets the torque limit value for reversed regenerative conditions as a percentage of the motor rated torque.	200% (0 - 300%)

**Note:**

- The lower torque limit is enabled when you set the torque limit by the following method.
  - Set H3-02, H3-06, or H3-10 = 10, 15 [MFAI Function Select = Forward, Reverse/Regenerative Torque Limit].
  - Use a communication option to set the torque limits
- You must think about drive capacity when a large quantity of torque is necessary. If you set the value too high, the drive can detect *oC* [Overcurrent].
- If you set the value too low with large loads, the motor can stall.

### ■ L7-06: Torque Limit Integral Time

No. (Hex.)	Name	Description	Default (Range)
L7-06 (04AC)	Torque Limit Integral Time	<input type="checkbox"/> V/f <input type="checkbox"/> CL-V/f <input checked="" type="checkbox"/> OLV <input type="checkbox"/> CLV <input type="checkbox"/> AOLV <input type="checkbox"/> OLV/PM <input type="checkbox"/> AOLV/PM <input type="checkbox"/> CLV/PM <input type="checkbox"/> EZOLV Sets the integral time constant for the torque limit function.	200 ms (5 - 10000 ms)

Decrease the setting value to increase torque limit responsiveness when you use torque limits and  $L7-07 = 1$  [Torque Limit during Accel/Decel = Proportional & Integral control].

If there is hunting when torque limits are active, increase the setting value.

### ■ L7-07: Torque Limit during Accel/Decel

No. (Hex.)	Name	Description	Default (Range)
L7-07 (04C9)	Torque Limit during Accel/Decel	<input type="checkbox"/> V/f <input type="checkbox"/> CL-V/f <input checked="" type="checkbox"/> OLV <input type="checkbox"/> CLV <input type="checkbox"/> AOLV <input type="checkbox"/> OLV/PM <input type="checkbox"/> AOLV/PM <input type="checkbox"/> CLV/PM <input type="checkbox"/> EZOLV Sets the torque limit function during acceleration and deceleration.	0 (0, 1)

#### 0 : Proportional only

The torque limit function works with proportional control during acceleration and deceleration, and switches to integral control at constant speed. Use this setting when acceleration and deceleration to the correct speed is more important than the torque limit during speed changes.

#### 1 : Proportional & Integral control

The torque limit function always uses integral control. Use this setting when a very accurate torque limit is necessary during speed changes, for example in winding machine applications.

If you make the torque limit the most important, it can:

- Increase the acceleration and deceleration times.
- Not let the motor speed reach the frequency reference value during run at constant speed.



### ■ L7-16: Torque Limit Process at Start

No. (Hex.)	Name	Description	Default (Range)
L7-16 (044D)	Torque Limit Process at Start	<input type="checkbox"/> V/f <input type="checkbox"/> CL-V/f <input checked="" type="checkbox"/> OLV <input checked="" type="checkbox"/> CLV <input checked="" type="checkbox"/> AOLV <input type="checkbox"/> OLV/PM <input type="checkbox"/> AOLV/PM <input type="checkbox"/> CLV/PM <input type="checkbox"/> EZOLV Assigns a time filter to allow the torque limit to build at start.	1 (0, 1)

#### 0 : Disabled

There is torque limit at start without a delay time.

Use this setting to maximize the response time when sudden acceleration or deceleration at start is necessary.

#### 1 : Enabled

There is a delay time of 64 ms at start to build the torque limit.

### ■ L7-35: Low Freq Regen Torque Limit Lvl

No. (Hex.)	Name	Description	Default (Range)
L7-35 (1B57) Expert	Low Freq Regen Torque Limit Lvl	<input type="checkbox"/> V/f <input type="checkbox"/> CL-V/f <input type="checkbox"/> OLV <input type="checkbox"/> CLV <input checked="" type="checkbox"/> AOLV <input type="checkbox"/> OLV/PM <input type="checkbox"/> AOLV/PM <input type="checkbox"/> CLV/PM <input type="checkbox"/> EZOLV Sets the torque limit used during low-speed regeneration. Usually it is not necessary to change this setting.	50.00% (0.00 - 200.00%)

Decreases the regenerative torque limit to the level set in L7-35 when you use a low frequency and the output frequency is less than L7-36 [Ope Freq Band for Derating Trq Lim Torque Limit]. The drive does not decrease torque limits during ramp to stop operation. If the drive detects *oC* [Overcurrent] when you input a regenerative load and the speed reference is constant, decrease this parameter.

#### Note:

- If the drive detects faults during regenerative loads at low speed, decrease this parameter in 10.00% increments and decrease the setting of L7-36 in 2.00 Hz increments.
- Setting values that are too high can cause faults.
- If you set this parameter > L7-03 [Forward Regenerative TorqueLimit] or L7-04 [Reverse Regenerative TorqueLimit], the torque limit reduction function will not operate.
- If you input a regenerative load at low speeds and set this parameter to a small value, it can cause the motor to rotate faster than the speed reference.

### ■ L7-36: Regen Torque Limit Derate Freq

No. (Hex.)	Name	Description	Default (Range)
L7-36 (1B58) Expert	Regen Torque Limit Derate Freq	<input type="checkbox"/> V/f <input type="checkbox"/> CL-V/f <input type="checkbox"/> OLV <input type="checkbox"/> CLV <input checked="" type="checkbox"/> AOLV <input type="checkbox"/> OLV/PM <input type="checkbox"/> AOLV/PM <input type="checkbox"/> CLV/PM <input type="checkbox"/> EZOLV Sets the frequency width at which L7-35 [Low Freq Regen Torque Limit Lvl] operates.	6.00 Hz (0.00 - 30.00 Hz)

If the drive detects *oC* [Overcurrent] faults when you connect regenerative loads at low speed, increase the setting value. Decreases the torque limit as specified by the setting of L7-35 in a range of  $0 \leq \text{output frequency} < \text{L7-36}$ . When the torque limit gradually changes as specified by the output frequency until the output frequency = L7-36, the value changes to the settings of L7-03 [Forward Regenerative TorqueLimit] and L7-04 [Reverse Regenerative TorqueLimit].

#### Note:

If you input a regenerative load at low speeds and set this parameter to a large value, it can cause the motor to rotate faster than the speed reference. Do not set the value higher than necessary.

## ◆ L8: Drive Protection

L8 parameters set protective functions that prevent faults such as overheating, phase loss, and ground faults.

### ■ L8-01: 3% ERF DB Resistor Protection

No. (Hex.)	Name	Description	Default (Range)
L8-01 (04AD)	3% ERF DB Resistor Protection	<div style="display: flex; justify-content: space-between; font-size: 0.8em; font-weight: bold;"> <span>V/f</span> <span>CL-V/f</span> <span>OLV</span> <span>CLV</span> <span>AOLV</span> <span>OLV/PM</span> <span>AOLV/PM</span> <span>CLV/PM</span> <span>EZOLV</span> </div> Sets the function to enable braking resistor protection with a Yaskawa ERF series braking resistor (3% ED) installed on the heatsink.	0 (0, 1)

#### 0 : Disabled

Disables braking resistor protection. Use this setting for dynamic braking options that are not Yaskawa ERF series braking resistors.

#### 1 : Enabled

Enables protection for Yaskawa ERF series braking resistors.

##### Note:

Set  $L8-01 = 1$  and  $H2-01$  to  $H2-03 = D$  [MFDO Function Select = Braking Resistor Fault]. Use a sequence to turn OFF power with MFDO.

### ■ L8-02: Overheat Alarm Level

No. (Hex.)	Name	Description	Default (Range)
L8-02 (04AE)	Overheat Alarm Level	<div style="display: flex; justify-content: space-between; font-size: 0.8em; font-weight: bold;"> <span>V/f</span> <span>CL-V/f</span> <span>OLV</span> <span>CLV</span> <span>AOLV</span> <span>OLV/PM</span> <span>AOLV/PM</span> <span>CLV/PM</span> <span>EZOLV</span> </div> Sets the <i>oH</i> detection level.	Determined by o2-04 and C6-01 (50 - 150 °C)

If the heatsink temperature is more than the temperature set in this parameter, the drive detects an overheat pre-alarm. To enable this function, set one of  $H2-01$  to  $H2-03$  [MFDO Function Select] to 20 [Drive Overheat Pre-Alarm (*oH*)].

If the temperature increases to the overheat fault level, the drive will trigger an *oH1* [Heatsink Overheat] fault and stop operation.

### ■ L8-03: Overheat Pre-Alarm Selection

No. (Hex.)	Name	Description	Default (Range)
L8-03 (04AF)	Overheat Pre-Alarm Selection	<div style="display: flex; justify-content: space-between; font-size: 0.8em; font-weight: bold;"> <span>V/f</span> <span>CL-V/f</span> <span>OLV</span> <span>CLV</span> <span>AOLV</span> <span>OLV/PM</span> <span>AOLV/PM</span> <span>CLV/PM</span> <span>EZOLV</span> </div> Sets operation after the drive detects an <i>oH</i> alarm.	3 (0 - 4)

#### 0 : Ramp to Stop

The drive ramps to stop in the selected deceleration time. Fault relay output terminal MA-MC will activate, and MB-MC will deactivate.

#### 1 : Coast to Stop

The drive output shuts off and the motor coasts to stop. Fault relay output terminal MA-MC will activate, and MB-MC will deactivate.

#### 2 : Fast Stop (Use C1-09)

The drive uses the deceleration time set in  $C1-09$  [Fast Stop Time] to stop the motor. Fault relay output terminal MA-MC will activate, and MB-MC will deactivate.

#### 3 : Alarm Only

*oH* is shown on the keypad and operation continues. The output terminal set for *Alarm* [ $H2-01$  to  $H2-03 = 10$ ] activates.

#### 4 : Operate at Reduced Speed (L8-19)

The drive decelerates to the level set in  $L8-19$  [Freq Reduction @ *oH* Pre-Alarm] and continues operation. *oH* flashes on the keypad.

The drive decelerates to the level set in  $L8-19$  [Freq Reduction @ *oH* Pre-Alarm] and continues operation. *oH* flashes on the keypad. If the *oH* alarm continues for 10 seconds, the drive decelerates again. When the alarm is output, the drive decelerates each 10 seconds. If the drive decelerates 10 times and the alarm continues to be output, the output terminal set for *oH Pre-Alarm Reduction Limit* [ $H2-01$  to  $H2-03 = 4D$ ] activates. When the alarm is not output during deceleration, the drive accelerates until it is at the frequency reference that was

applicable before the alarm was turned off. Figure 11.146 shows the output of the alarm and the drive operation at a decreased output frequency.

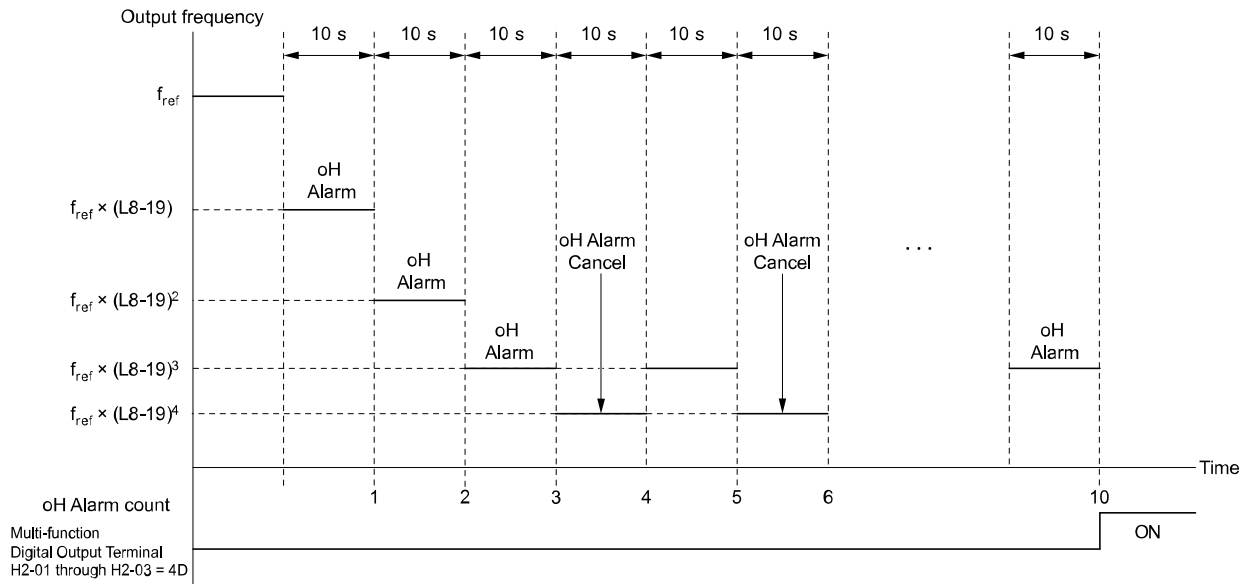


Figure 11.146 Drive Operation at a Decreased Output Frequency when the Overheat Alarm is Output

### ■ L8-05: Input Phase Loss Protection Sel

No. (Hex.)	Name	Description	Default (Range)
L8-05 (04B1)	Input Phase Loss Protection Sel	<b>V/f</b> <b>CL-V/f</b> <b>OLV</b> <b>CLV</b> <b>AOLV</b> <b>OLV/PM</b> <b>AOLV/PM</b> <b>CLV/PM</b> <b>EZOLV</b> Sets the function to enable and disable input phase loss detection.	1 (0, 1)

**0 : Disabled**

**1 : Enabled**

The drive measures ripples in DC bus voltage to detect input phase loss.

The drive detects phase loss when power supply phase loss occurs or the main circuit capacitor becomes unusable, which causes *PF [Input Phase Loss]* to show on the keypad.

Disable the detection of the input power supply phase loss function in these conditions:

- During deceleration
- The run command is not input
- The output current is less than 30% of the drive rated current.

### ■ L8-07: Output Phase Loss Protection Sel

No. (Hex.)	Name	Description	Default (Range)
L8-07 (04B3)	Output Phase Loss Protection Sel	<b>V/f</b> <b>CL-V/f</b> <b>OLV</b> <b>CLV</b> <b>AOLV</b> <b>OLV/PM</b> <b>AOLV/PM</b> <b>CLV/PM</b> <b>EZOLV</b> Sets the function to enable and disable output phase loss detection. The drive starts output phase loss detection when the output current decreases to less than 5% of the drive rated current.	0 (0 - 2)

**Note:**

The drive can incorrectly start output phase loss detection in these conditions:

- The motor rated current is very small compared to the drive rating.
- The drive is operating a PM motor with a small load.

**0 : Disabled**

**1 : Fault when one phase is lost**

If the drive loses one output phase, it will trigger *LF [Output Phase Loss]*.

The output turns off and the motor coasts to stop.

**2 : Fault when two phases are lost**

If the drive loses more than one output phase, it will trigger *LF [Output Phase Loss]*.

The output turns off and the motor coasts to stop.

### ■ L8-09: Output Ground Fault Detection

No. (Hex.)	Name	Description	Default (Range)
L8-09 (04B5)	Output Ground Fault Detection	<b>V/f</b> <b>CL-V/f</b> <b>OLV</b> <b>CLV</b> <b>AOLV</b> <b>OLV/IPM</b> <b>AOLV/IPM</b> <b>CLV/IPM</b> <b>EZOLV</b> Sets the function to enable and disable ground fault protection.	Determined by o2-04 (0, 1)

#### 0 : Disabled

The drive will not detect ground faults.

#### 1 : Enabled

If there is high leakage current or a ground short circuit in one or two output phases, the drive will detect *GF* [Ground Fault].

**Note:**

If the ground path impedance is low, *oC* [Overcurrent], *SC* [Out Short Circuit or IGBT Fault], or *ov* [DC Bus Overvoltage] can stop the motor.

### ■ L8-10: Heatsink Fan Operation Selection

No. (Hex.)	Name	Description	Default (Range)
L8-10 (04B6)	Heatsink Fan Operation Selection	<b>V/f</b> <b>CL-V/f</b> <b>OLV</b> <b>CLV</b> <b>AOLV</b> <b>OLV/IPM</b> <b>AOLV/IPM</b> <b>CLV/IPM</b> <b>EZOLV</b> Sets operation of the heatsink cooling fan.	0 (0 - 2)

#### 0 : During Run, w/ L8-11 Off-Delay

The drive turns on the fan when a Run command is active.

#### 1 : Always On

The fan turns on when you supply power to the drive. When you release the Run command and the delay time set in *L8-11* [HeatsinkCoolingFan OffDelayTime] is expired, the fan stops. his setting extends the fan lifetime.

#### 2 : On when Drive Temp Reaches L8-64

The fan turns on when the drive detects that the main circuit is overheating.

### ■ L8-11: Heatsink Fan Off-Delay Time

No. (Hex.)	Name	Description	Default (Range)
L8-11 (04B7)	Heatsink Fan Off-Delay Time	<b>V/f</b> <b>CL-V/f</b> <b>OLV</b> <b>CLV</b> <b>AOLV</b> <b>OLV/IPM</b> <b>AOLV/IPM</b> <b>CLV/IPM</b> <b>EZOLV</b> Sets the length of time that the drive will wait before stopping the cooling fan after cancelling the Run command when <i>L8-10</i> = 0 [Heatsink Cooling Fan Ope Select = Dur Run (OffDly)].	60 s (0 - 300 s)

### ■ L8-12: Ambient Temperature Setting

No. (Hex.)	Name	Description	Default (Range)
L8-12 (04B8)	Ambient Temperature Setting	<b>V/f</b> <b>CL-V/f</b> <b>OLV</b> <b>CLV</b> <b>AOLV</b> <b>OLV/IPM</b> <b>AOLV/IPM</b> <b>CLV/IPM</b> <b>EZOLV</b> Sets the ambient temperature of the drive installation area.	40 °C (-10 - +50 °C)

The drive automatically adjusts the drive rated current to the best value as specified by the set temperature. Set the ambient temperature of the area where you install the drive to a value that is more than the drive rating.

### ■ L8-15: Drive oL2 @ Low Speed Protection

No. (Hex.)	Name	Description	Default (Range)
L8-15 (04BB)	Drive oL2 @ Low Speed Protection	<b>V/f</b> <b>CL-V/f</b> <b>OLV</b> <b>CLV</b> <b>AOLV</b> <b>OLV/IPM</b> <b>AOLV/IPM</b> <b>CLV/IPM</b> <b>EZOLV</b> Sets the function to decrease drive overload at low speeds to prevent damage to the main circuit transistor during low speed operation (at 6 Hz or slower) to prevent <i>oL2</i> [Drive Overloaded].	1 (0, 1)

**Note:**

Contact Yaskawa or your nearest sales representative for consultation before disabling this function at low speeds. Frequent operation of drives under conditions of high output current in low speed ranges may shorten the service life of the drive IGBT due to heat stress.

**0 : Disabled (No Additional Derate)**

The drive does not decrease the overload protection level.

**1 : Enabled (Reduced oL2 Level)**

When the drive detects *oL2* during low speed operation, it automatically decreases the overload detection level. At zero speed, the drive derates the overload by 50%.

**■ L8-18: Software Current Limit Selection**

No. (Hex.)	Name	Description	Default (Range)
L8-18 (04BE)	Software Current Limit Selection	<input checked="" type="checkbox"/> V/f <input checked="" type="checkbox"/> CL-V/f <input checked="" type="checkbox"/> OLV <input checked="" type="checkbox"/> CLV <input checked="" type="checkbox"/> AOLV <input checked="" type="checkbox"/> OLV/PM <input checked="" type="checkbox"/> AOLV/PM <input checked="" type="checkbox"/> CLV/PM <input checked="" type="checkbox"/> EZOLV Set the software current limit selection function to prevent damage to the main circuit transistor caused by too much current.	0 (0, 1)

**0 : Disabled**

When the output current is at the software current limit value, the drive does not restrict the output voltage.

**Note:**

The drive may detect an *oC* [Overcurrent] when loads are particularly heavy or the acceleration time is particularly short.

**1 : Enabled**

When the output current is at the software current limit value, the drive decreases output voltage to decrease output current.

When the output current decreases to the software current limit level, the drive starts usual operation.

**■ L8-19: Freq Reduction @ oH Pre-Alarm**

No. (Hex.)	Name	Description	Default (Range)
L8-19 (04BF)	Freq Reduction @ oH Pre-Alarm	<input checked="" type="checkbox"/> V/f <input checked="" type="checkbox"/> CL-V/f <input checked="" type="checkbox"/> OLV <input checked="" type="checkbox"/> CLV <input checked="" type="checkbox"/> AOLV <input checked="" type="checkbox"/> OLV/PM <input checked="" type="checkbox"/> AOLV/PM <input checked="" type="checkbox"/> CLV/PM <input checked="" type="checkbox"/> EZOLV Sets the ratio at which the drive derates the frequency reference when during an <i>oH</i> alarm.	0.8 (0.1 to 0.9)

When these two conditions are correct, this function is enabled:

- $L8-03 = 4$  [Overheat Pre-Alarm Ope Selection = Run@L8-19 Rate]
- *oH* alarm is output

**■ L8-20: Control Fault & Step Out Detect**

No. (Hex.)	Name	Description	Default (Range)
L8-20 (04C0) Expert	Control Fault & Step Out Detect	<input checked="" type="checkbox"/> V/f <input checked="" type="checkbox"/> CL-V/f <input checked="" type="checkbox"/> OLV <input checked="" type="checkbox"/> CLV <input checked="" type="checkbox"/> AOLV <input checked="" type="checkbox"/> OLV/PM <input checked="" type="checkbox"/> AOLV/PM <input checked="" type="checkbox"/> CLV/PM <input checked="" type="checkbox"/> EZOLV Sets operation after the drive detects a <i>CF</i> fault when $A1-02 = 4$ [Control Method Selection = Advanced Open Loop Vector].	1 (0 - 2)

If you enter a Stop command but it cannot stop drive operation, the drive will detect *CF*.

**0 : Disabled****1 : CF/STPo Detection Enabled****2 : CF ALM/Stop**

The drive stops DC injection braking as specified by the value of  $b2-03$  [DC Inject Braking Time at Start].

**Note:**

- If  $A1-02 = 4$  and you do not do Rotational Auto-Tuning, control will not be stable. This can cause *CF* faults when you ramp to stop. If the drive detects *CF*, do Rotational Auto-Tuning and Line-to-Line Resistance Tuning.
- If you input a Stop command while the motor rotates on the load side and  $A1-02 = 4$  to use torque control, load conditions can cause operation to not stop and can also cause *CF* faults. Make sure that you do Rotational Auto-Tuning and Line-to-Line Resistance Tuning correctly and then set  $L8-20 = 0$ .

■ **L8-27: Overcurrent Detection Gain**

No. (Hex.)	Name	Description	Default (Range)
L8-27 (04DD)	Overcurrent Detection Gain	<div style="display: flex; justify-content: space-between; font-size: 0.8em; font-weight: normal;"> <span>V/f</span> <span>CL-V/f</span> <span>OLV</span> <span>CLV</span> <span>AOLV</span> <span style="background-color: #cccccc;">OLV/PM</span> <span style="background-color: #cccccc;">AOLV/PM</span> <span style="background-color: #cccccc;">CLV/PM</span> <span style="background-color: #cccccc;">EZOLV</span> </div> <p>Sets the PM motor overcurrent detection level as a percentage of the motor rated current value.</p>	300.0% (0.0 - 400.0%)

If the drive rated current is much higher than the motor rated current, PM motor magnets can demagnetize when current flows at the drive overcurrent detection level. When the overcurrent detection level is low, adjust this parameter to prevent motor demagnetization.

If you set *L7-xx [Torque Limit]* and *L8-27* to the same value or almost the same value, the drive can detect *oC [Overcurrent]*. Lower the torque limit when you use a Yaskawa motor. When you use a non-Yaskawa motor, measure the irreversible demagnetization resistance before you adjust this parameter.

**Note:**

The overcurrent detection function detects the lower of these two values:

- Drive overcurrent level
- Motor rated current × *L8-27* / 100

■ **L8-29: Output Unbalance Detection Sel**

No. (Hex.)	Name	Description	Default (Range)
L8-29 (04DF)	Output Unbalance Detection Sel	<div style="display: flex; justify-content: space-between; font-size: 0.8em; font-weight: normal;"> <span>V/f</span> <span>CL-V/f</span> <span>OLV</span> <span>CLV</span> <span>AOLV</span> <span style="background-color: #cccccc;">OLV/PM</span> <span style="background-color: #cccccc;">AOLV/PM</span> <span style="background-color: #cccccc;">CLV/PM</span> <span style="background-color: #cccccc;">EZOLV</span> </div> <p>Sets the function to detect <i>LF2</i>.</p>	1 (0, 1)

This function prevents damage to PM motors. Current unbalance can heat a PM motor and demagnetize the magnets. When the current is unbalanced, the drive will detect *LF2* to stop the motor and prevent damage to the motor.

**0 : Disabled**

**1 : Enabled**

■ **L8-31: LF2 Detection Time**

No. (Hex.)	Name	Description	Default (Range)
L8-31 (04E1)	LF2 Detection Time	<div style="display: flex; justify-content: space-between; font-size: 0.8em; font-weight: normal;"> <span>V/f</span> <span>CL-V/f</span> <span>OLV</span> <span>CLV</span> <span>AOLV</span> <span style="background-color: #cccccc;">OLV/PM</span> <span style="background-color: #cccccc;">AOLV/PM</span> <span style="background-color: #cccccc;">CLV/PM</span> <span style="background-color: #cccccc;">EZOLV</span> </div> <p>Sets the LF2 [Output Current Imbalance] detection time.</p>	3 (1 to 100)

When the output current is unbalanced for longer than the time set in *L8-31*, the drive detects *LF2*.

**Note:**

- Set *L8-29* = 1 [*Current Unbalance Detect (LF2) = Enabled*] to enable this parameter.
- If the drive detects *LF2* by error, increase the setting value of *L8-31* in 5-unit increments.
- The operator shows this parameter when *E9-01* = 1 [*Motor Type Selection = PM*] under EZ Open Loop Vector Control.

■ **L8-32: Cooling Fan Failure Selection**

No. (Hex.)	Name	Description	Default (Range)
L8-32 (04E2)	Cooling Fan Failure Selection	<div style="display: flex; justify-content: space-between; font-size: 0.8em; font-weight: normal;"> <span>V/f</span> <span>CL-V/f</span> <span>OLV</span> <span>CLV</span> <span>AOLV</span> <span style="background-color: #cccccc;">OLV/PM</span> <span style="background-color: #cccccc;">AOLV/PM</span> <span style="background-color: #cccccc;">CLV/PM</span> <span style="background-color: #cccccc;">EZOLV</span> </div> <p>Sets operation when the drive detects <i>FAn [Internal Agitating Fan Fault]</i>.</p>	1 (0 - 4)

**0 : Ramp to Stop**

The drive ramps to stop in the selected deceleration time. Fault relay output terminal MA-MC will activate, and MB-MC will deactivate.

**1 : Coast to Stop**

The drive output shuts off and the motor coasts to stop. Fault relay output terminal MA-MC will activate, and MB-MC will deactivate.

**2 : Fast Stop (Use C1-09)**

The drive uses the deceleration time set in *C1-09 [Fast Stop Time]* to stop the motor. Fault relay output terminal MA-MC will activate, and MB-MC will deactivate.

### 3 : Alarm Only

*oH* is shown on the keypad and operation continues. The output terminal set for Alarm [*H2-01 to H2-03 = 10*] activates.

### 4 : Operate at Reduced Speed (L8-19)

The drive decelerates to the level set in *L8-19 [Freq Reduction @ oH Pre-Alarm]* and continues operation. *FAN* flashes on the keypad. Refer to “L8-03: Overheat Pre-Alarm Ope Selection” for more information about drive derating operation.

## ■ L8-35: Installation Method Selection

No. (Hex.)	Name	Description	Default (Range)
L8-35 (04EC)	Installation Method Selection	<div style="display: flex; gap: 5px;"> <span>V/f</span> <span>CL-V/f</span> <span>OLV</span> <span>CLV</span> <span>AOLV</span> <span>OLV/PM</span> <span>AOLV/PM</span> <span>CLV/PM</span> <span>EZOLV</span> </div> Sets the type of drive installation.	Determined by the drive model (0 - 3)

#### Note:

- Parameter *A1-03 [Initialize Parameters]* does not initialize this parameter.
- This parameter is set to the correct value when the drive is shipped. Change the value only in these conditions:
  - Side-by-Side installation
  - Mounting a standard drive with the heatsink outside the enclosure panel.

The overload protection detection level for the drive is automatically adjusted to the optimal value in accordance with the setting value. Change this setting when drives are installed Side-by-Side or when mounting a standard drive with the heatsink outside the enclosure panel.

### 0 : IP20/Open-Chassis enclosure

Use this setting to install an IP20 Open Type enclosure drive.

Make sure that there is 30 mm (1.18 in) minimum of space between drives or between the drive and side of the enclosure panel.

### 1 : Side-by-Side Mounting

Use this setting to install more than one drive Side-by-Side.

Make sure that there is 2 mm (0.08 in) minimum of space between drives.

### 2 : IP21/NEMA Type 1/IP55

Use this setting to install UL Type 1 enclosed wall-mounted type drives or IP55 drives.

### 3 : Finless / External Heatsink

Use this setting to install finless type drives or when the heatsink (cooling fin) is outside the enclosure panel.

## ■ L8-38: Carrier Frequency Reduction

No. (Hex.)	Name	Description	Default (Range)
L8-38 (04EF)	Carrier Frequency Reduction	<div style="display: flex; gap: 5px;"> <span>V/f</span> <span>CL-V/f</span> <span>OLV</span> <span>CLV</span> <span>AOLV</span> <span>OLV/PM</span> <span>AOLV/PM</span> <span>CLV/PM</span> <span>EZOLV</span> </div> Sets the carrier frequency reduction function. The drive reduces the carrier frequency when the output current is more than a specified level.	Determined by A1-02, C6-01, and o2-04 (0 - 2)

If you decrease the carrier frequency, it increases the overload tolerance. The overload capacity increases temporarily for *oL2 [Drive Overloaded]* and lets the drive operate through transient load peaks and not trip.

### 0 : Disabled

The drive will not decrease the carrier frequency at high current.

### 1 : Enabled below 6 Hz

The drive decreases the carrier frequency at speeds less than 6 Hz when the current is more than 100% of the drive rated current.

When the current is less than 88% or the output frequency is more than 7 Hz, the drive goes back to the usual carrier frequency.

### 2 : Enabled for All Speeds

The drive decreases the carrier frequency at these speeds:

- Output current is a minimum of 100% of the drive rated current and the frequency reference is less than 6 Hz.
- Output current is a minimum of 109% of the drive rated current, the drive is in Normal Duty mode, and the frequency reference is 7 Hz or more.
- Output current is a minimum of 112% of the drive rated current, the drive is in Heavy Duty mode, and the frequency reference is 7 Hz or more.

When the drive switches the carrier frequency to the set value, it uses the delay time set in *L8-40* [*CarrierFreqReduct Off DelayTime*] and a hysteresis of 12%.

■ **L8-40: Carrier Freq Reduction Off-Delay**

No. (Hex.)	Name	Description	Default (Range)
L8-40 (04F1)	Carrier Freq Reduction Off-Delay	<div style="display: flex; justify-content: space-between; font-size: small;"> <span>V/f</span> <span>CL-V/f</span> <span>OLV</span> <span>CLV</span> <span>AOLV</span> <span>OLV/PM</span> <span>AOLV/PM</span> <span>CLV/PM</span> <span>EZOLV</span> </div> Sets the length of time until the automatically reduced carrier frequency returns to the condition before the reduction.	Determined by A1-02 (0.00 - 2.00 s)

Set *L8-40*  $\neq 0.00$  to enable the carrier frequency reduction function during start-up. When operation starts, the drive automatically decreases the carrier frequency. When the time set in *L8-40* is expired, the carrier frequency returns to the value set in *C6-02* [*Carrier Frequency Selection*].

When *L8-38* = 1, 2 [*Carrier Frequency Reduction = Enabled*], the drive applies *L8-40* as the time for the carrier frequency to return to its configured value after it is decreased.

■ **L8-41: High Current Alarm Selection**

No. (Hex.)	Name	Description	Default (Range)
L8-41 (04F2)	High Current Alarm Selection	<div style="display: flex; justify-content: space-between; font-size: small;"> <span>V/f</span> <span>CL-V/f</span> <span>OLV</span> <span>CLV</span> <span>AOLV</span> <span>OLV/PM</span> <span>AOLV/PM</span> <span>CLV/PM</span> <span>EZOLV</span> </div> Sets the function to cause an <i>HCA</i> [ <i>Current Alarm</i> ] when the output current is more than 150% of the drive rated current.	0 (0, 1)

**0 : Disabled**

The drive will not detect *HCA* [*Current Alarm*].

**1 : Enabled**

If the output current is more than 150% of the drive rated current, the drive will detect *HCA*.

The MFDO terminal set for an alarm [*H2-01 to H2-03* = 10] activates.

■ **L8-51: STPo I Detection Level**

No. (Hex.)	Name	Description	Default (Range)
L8-51 (0471) Expert	STPo I Detection Level	<div style="display: flex; justify-content: space-between; font-size: small;"> <span>V/f</span> <span>CL-V/f</span> <span>OLV</span> <span>CLV</span> <span>AOLV</span> <span>OLV/PM</span> <span>AOLV/PM</span> <span>CLV/PM</span> <span>EZOLV</span> </div> Sets the <i>STPo</i> [ <i>Desynchronization Error</i> ] detection level as a percentage of the output current.	0.0% (0.0 - 300.0%)

**Note:**

The detection level is automatically calculated when *L8-51* = 0.

■ **L8-52: STPo Integration Level**

No. (Hex.)	Name	Description	Default (Range)
L8-52 (0472) Expert	STPo Integration Level	<div style="display: flex; justify-content: space-between; font-size: small;"> <span>V/f</span> <span>CL-V/f</span> <span>OLV</span> <span>CLV</span> <span>AOLV</span> <span>OLV/PM</span> <span>AOLV/PM</span> <span>CLV/PM</span> <span>EZOLV</span> </div> Sets the detection level for <i>STPo</i> [ <i>Desynchronization Error</i> ] related to the ACR integral value.	1.0 (0.1 - 2.0)



### ■ L8-53: STPo Integration Time

No. (Hex.)	Name	Description	Default (Range)
L8-53 (0473) Expert	STPo Integration Time	<span>V/f</span> <span>CL-V/f</span> <span>OLV</span> <span>CLV</span> <span>AOLV</span> <span><b>OLV/PM</b></span> <span>AOLV/PM</span> <span>CLV/PM</span> <span>EZOLV</span> Sets the length of time until the drive detects <i>STPo</i> after exceeding the value of L8-51 [ <i>STPo I Detection Level</i> ].	1.0 s (1.0 - 10.0 s)

### ■ L8-54: STPo Id Diff Detection

No. (Hex.)	Name	Description	Default (Range)
L8-54 (0474) Expert	STPo Id Diff Detection	<span>V/f</span> <span>CL-V/f</span> <span>OLV</span> <span>CLV</span> <span>AOLV</span> <span><b>OLV/PM</b></span> <span>AOLV/PM</span> <span>CLV/PM</span> <span><b>EZOLV</b></span> Sets the Id deviation detection function for <i>STPo</i> [ <i>Desynchronization Error</i> ].	1 (0, 1)

0 : Disabled

1 : Enabled

### ■ L8-55: Internal DB TransistorProtection

No. (Hex.)	Name	Description	Default (Range)
L8-55 (045F)	Internal DB TransistorProtection	<span>V/f</span> <span>CL-V/f</span> <span>OLV</span> <span>CLV</span> <span>AOLV</span> <span><b>OLV/PM</b></span> <span>AOLV/PM</span> <span>CLV/PM</span> <span><b>EZOLV</b></span> Sets the protection function for the internal braking transistor.	1 (0, 1)

0 : Disable

Disables braking transistor protection.

Use this setting, if enabling the braking transistor can cause an *rF* [*Braking Resistor Fault*] in these conditions:

- With a regenerative converter, for example D1000.
- With a regenerative unit, for example R1000.
- When connecting braking resistor options to the drive, for example CDBR units.
- Without an internal braking transistor.

1 : Protection Enabled

Prevents damage to the internal braking transistor when using a braking transistor or optional braking resistors.

These models have a built-in braking transistor:

- 2004 to 2138
- 4002 to 4168

### ■ L8-56: Stall P @ Accel Activation Time

No. (Hex.)	Name	Description	Default (Range)
L8-56 (047D) Expert	Stall P @ Accel Activation Time	<span>V/f</span> <span>CL-V/f</span> <span>OLV</span> <span>CLV</span> <span>AOLV</span> <span><b>OLV/PM</b></span> <span>AOLV/PM</span> <span>CLV/PM</span> <span>EZOLV</span> Sets the length time that the acceleration stall prevention function can continue to operate before the drive detects an <i>STPo</i> [ <i>Desynchronization Error</i> ].	5000 ms (100 - 5000 ms)

Note:

If this value is too small, it can cause incorrect detection of *STPo*. If this value is too large, the drive will not detect *STPo*.

### ■ L8-57: Stall Prevention Retry Counts

No. (Hex.)	Name	Description	Default (Range)
L8-57 (047E) Expert	Stall Prevention Retry Counts	<span>V/f</span> <span>CL-V/f</span> <span>OLV</span> <span>CLV</span> <span>AOLV</span> <span><b>OLV/PM</b></span> <span>AOLV/PM</span> <span>CLV/PM</span> <span>EZOLV</span> Sets the number of times the acceleration stall prevention function can operate until speeds match before the drive detects an <i>STPo</i> [ <i>Desynchronization Error</i> ].	10 times (1 - 10 times)

**Note:**

If this value is too small, it can cause incorrect detection of *STPo*. If this value is too large, the drive will not detect *STPo*.

■ **L8-90: STPo Detection Level (Low Speed)**

No. (Hex.)	Name	Description	Default (Range)
L8-90 (0175) Expert	STPo Detection Level (Low Speed)	<span>V/f</span> <span>CL-V/f</span> <span>OLV</span> <span>CLV</span> <span>AOLV</span> <span>OLV/PM</span> <span>AOLV/PM</span> <span>CLV/PM</span> <span>EZOLV</span> Sets the detection level that the control fault must be equal to or more than to cause an <i>STPo</i> [ <i>Desynchronization Error</i> ].	Determined by A1-02 (0 - 5000 times)

This function detects when PM motors are not synchronized.

The drive cannot detect when motors are not synchronized because the frequency reference is low during start up and the motor is locked. If fault detection is necessary in these conditions, set the control fault detection level to enable detection of desynchronization because of motor locking. Increase the setting in 5-unit increments.

■ **L8-93: Low Speed Pull-out DetectionTime**

No. (Hex.)	Name	Description	Default (Range)
L8-93 (073C) Expert	Low Speed Pull-out DetectionTime	<span>V/f</span> <span>CL-V/f</span> <span>OLV</span> <span>CLV</span> <span>AOLV</span> <span>OLV/PM</span> <span>AOLV/PM</span> <span>CLV/PM</span> <span>EZOLV</span> Sets the length of time the drive will wait to start baseblock after detecting <i>LSo</i> [ <i>LSo Fault</i> ].	1.0 s (0.0 - 10.0 s)

Set this parameter to 0.0 to disable the function.

■ **L8-94: Low Speed Pull-out Detect Level**

No. (Hex.)	Name	Description	Default (Range)
L8-94 (073D) Expert	Low Speed Pull-out Detect Level	<span>V/f</span> <span>CL-V/f</span> <span>OLV</span> <span>CLV</span> <span>AOLV</span> <span>OLV/PM</span> <span>AOLV/PM</span> <span>CLV/PM</span> <span>EZOLV</span> Sets the detection level for <i>LSo</i> [ <i>Low Speed Motor Step-Out</i> ] as a percentage of <i>E1-04</i> [ <i>Maximum Output Frequency</i> ].	3% (0 - 10%)

■ **L8-95: Low Speed Pull-out Amount**

No. (Hex.)	Name	Description	Default (Range)
L8-95 (077F) Expert	Low Speed Pull-out Amount	<span>V/f</span> <span>CL-V/f</span> <span>OLV</span> <span>CLV</span> <span>AOLV</span> <span>OLV/PM</span> <span>AOLV/PM</span> <span>CLV/PM</span> <span>EZOLV</span> Sets the average count of <i>LSo</i> [ <i>Low Speed Motor Step-Out</i> ] detections.	10 times (1 - 50 times)

◆ **L9: Drive Protection 2**

*L9 parameters* are used to configure the protection function used to detect cooling fan faults.

■ **L9-16: FAn1 Detect Time**

No. (Hex.)	Name	Description	Default (Range)
L9-16 (11DC) Expert	FAn1 Detect Time	<span>V/f</span> <span>CL-V/f</span> <span>OLV</span> <span>CLV</span> <span>AOLV</span> <span>OLV/PM</span> <span>AOLV/PM</span> <span>CLV/PM</span> <span>EZOLV</span> Sets the detection time for <i>FAn1</i> [ <i>Drive Cooling Fan Failure</i> ]. Yaskawa recommends that you do not change this parameter value.	4.0 s (0.0 - 30.0 s)

## 11.10 n: Special Adjustment

*n* parameters set these functions:

- Function to prevent hunting
- High-slip braking
- Motor line-to-line resistance online tuning
- Fine-tune the parameters that adjust motor control

### ◆ n1: Hunting Prevention

The Hunting Prevention function will not let low inertia or operation with a light load cause hunting. Hunting frequently occurs when you have a high carrier frequency and an output frequency less than 30 Hz.

#### ■ n1-01: Hunting Prevention Selection

No. (Hex.)	Name	Description	Default (Range)
n1-01 (0580)	Hunting Prevention Selection	<input checked="" type="checkbox"/> V/f <input type="checkbox"/> CL-V/f <input type="checkbox"/> OLV <input type="checkbox"/> CLV <input type="checkbox"/> AOLV <input type="checkbox"/> OLV/PM <input type="checkbox"/> AOLV/PM <input type="checkbox"/> CLV/PM <input type="checkbox"/> EZOLV Sets the function to prevent hunting.	Determined by o2-04 (0 - 2)

When drive response is more important than the decrease of motor vibration, disable this function.

If hunting occurs, or if you use a high carrier frequency or SwingPWM, set this parameter to 2 for better hunting prevention.

**0 : Disabled**

**1 : Enabled (Normal)**

**2 : Enabled (High Carrier Frequency)**

#### ■ n1-02: Hunting Prevention Gain Setting

No. (Hex.)	Name	Description	Default (Range)
n1-02 (0581) Expert	Hunting Prevention Gain Setting	<input checked="" type="checkbox"/> V/f <input checked="" type="checkbox"/> CL-V/f <input type="checkbox"/> OLV <input type="checkbox"/> CLV <input type="checkbox"/> AOLV <input type="checkbox"/> OLV/PM <input type="checkbox"/> AOLV/PM <input type="checkbox"/> CLV/PM <input type="checkbox"/> EZOLV Adjusts the behavior of the hunting prevention function. Usually it is not necessary to change this setting.	1.00 (0.00 - 2.50)

Adjust this parameter in these conditions:

- When  $n1-01 = 1, 2$  [*Hunting Prevention Selection = Enabled (Normal), Enabled (High Carrier Frequency)*]: If oscillation occurs when you operate a motor with a light load, increase the setting value in 0.1-unit increments.
- When  $n1-01 = 1, 2$ , if the motor stalls: Decrease the setting value in 0.1-unit increments.

#### ■ n1-03: Hunting Prevention Time Constant

No. (Hex.)	Name	Description	Default (Range)
n1-03 (0582) Expert	Hunting Prevention Time Constant	<input checked="" type="checkbox"/> V/f <input checked="" type="checkbox"/> CL-V/f <input type="checkbox"/> OLV <input type="checkbox"/> CLV <input type="checkbox"/> AOLV <input type="checkbox"/> OLV/PM <input type="checkbox"/> AOLV/PM <input type="checkbox"/> CLV/PM <input type="checkbox"/> EZOLV Sets the primary delay time constant of the hunting prevention function. Usually it is not necessary to change this setting.	Determined by o2-04 (0 - 500 ms)

Adjust this parameter in these conditions:

- Load inertia is large: Increase the setting value. If the setting value is too high, response will be slower. Also, there will be oscillation when the frequency is low.
- Oscillation occurs at low frequencies: Decrease the setting value.

### ■ n1-05: Hunting Prevent Gain in Reverse

No. (Hex.)	Name	Description	Default (Range)
n1-05 (0530) Expert	Hunting Prevent Gain in Reverse	<b>V/f</b> <b>CL-V/f</b> <b>OLV</b> <b>CLV</b> <b>AOLV</b> <b>OLV/PM</b> <b>AOLV/PM</b> <b>CLV/PM</b> <b>EZOLV</b> Sets the performance of the hunting prevention function. This parameter adjusts Reverse run. Usually it is not necessary to change this setting.	0.00 (0.00 - 2.50)

**Note:**

When you set this parameter to 0, the value set in *n1-02* [Hunting Prevention Gain Setting] is effective when the motor rotates in reverse.

Adjust this parameter in these conditions:

- When *n1-01* = 1, 2 [Hunting Prevention Selection = Enabled (Normal), Enabled (High Carrier Frequency)]: If oscillation occurs when you operate a motor with a light load, increase the setting value in 0.1-unit increments.
- When *n1-01* = 1, 2, if the motor stalls: Decrease the setting value in 0.1-unit increments.

### ■ n1-08: Current Detection Method

No. (Hex.)	Name	Description	Default (Range)
n1-08 (1105) Expert	Current Detection Method	<b>V/f</b> <b>CL-V/f</b> <b>OLV</b> <b>CLV</b> <b>AOLV</b> <b>OLV/PM</b> <b>AOLV/PM</b> <b>CLV/PM</b> <b>EZOLV</b> Sets how the drive decreases the motor vibration that is caused by leakage current. Usually it is not necessary to change this setting.	0 (0, 1)

**0 : 2-Phases**

**1 : 3-Phases**

**Note:**

Set this parameter to 1 to suppress motor vibrations caused by leakage current when the wiring distance is long.

### ■ n1-13: DC Bus Stabilization Control

No. (Hex.)	Name	Description	Default (Range)
n1-13 (1B59) Expert	DC Bus Stabilization Control	<b>V/f</b> <b>CL-V/f</b> <b>OLV</b> <b>CLV</b> <b>AOLV</b> <b>OLV/PM</b> <b>AOLV/PM</b> <b>CLV/PM</b> <b>EZOLV</b> Sets the oscillation suppression function for the DC bus voltage.	0 (0, 1)

**0 : Disabled**

**1 : Enabled**

**Note:**

If the DC bus voltage does not become stable with light loads and the drive detects *ov* [Overvoltage], set this parameter to 1.

### ■ n1-14: DC Bus Stabilization Time

No. (Hex.)	Name	Description	Default (Range)
n1-14 (1B5A) Expert	DC Bus Stabilization Time	<b>V/f</b> <b>CL-V/f</b> <b>OLV</b> <b>CLV</b> <b>AOLV</b> <b>OLV/PM</b> <b>AOLV/PM</b> <b>CLV/PM</b> <b>EZOLV</b> Sets a length of time for the drive to suppress oscillation in relation to the DC bus voltage. Set <i>n1-13</i> = 1 [DC Bus Stabilization Control = Enabled] to enable this parameter.	100.0 ms (50.0 - 500.0 ms)

**Note:**

Adjust this parameter in 100 ms increments.

### ■ n1-15: PWM Voltage Offset Calibration

No. (Hex.)	Name	Description	Default (Range)
n1-15 (0BF8) Expert	PWM Voltage Offset Calibration	<b>V/f</b> <b>CL-V/f</b> <b>OLV</b> <b>CLV</b> <b>AOLV</b> <b>OLV/PM</b> <b>AOLV/PM</b> <b>CLV/PM</b> <b>EZOLV</b> Sets the calibration method that the drive uses to decrease torque/current ripple.	Determined by A1-02 (0 - 2)

This calibration function lets the drive suppress the torque ripple of a motor. Usually it is not necessary to change this setting.

### 0 : No Calibration

### 1 : One Time Calibrate at Next Start

### 2 : Calibrate Every Time at Start

## ■ n1-16: Hunting Prevention High Fc Gain

No. (Hex.)	Name	Description	Default (Range)
n1-16 (0BFB)	Hunting Prevention High Fc Gain	<div style="display: flex; justify-content: space-between; font-size: 0.8em;"> <span>V/f</span> <span>CL-V/f</span> <span>OLV</span> <span>CLV</span> <span>AOLV</span> <span>OLV/PM</span> <span>AOLV/PM</span> <span>CLV/PM</span> <span>EZOLV</span> </div> <p>Sets the gain for the hunting prevention function. This parameter functions best with a high carrier frequency. Usually it is not necessary to change this setting.</p>	Determined by o2-04 (0.00 - 2.50)

Set  $n1-01 = 2$  [*Hunting Prevention Selection = Enabled (High Carrier Frequency)*] to enable this function.

If the motor oscillates, set  $n1-01 = 2$ . If that does not have an effect, increase this parameter in 0.2-unit increments.

## ■ n1-17: Hunting Prevent High Fc Filter

No. (Hex.)	Name	Description	Default (Range)
n1-17 (0BFC) Expert	Hunting Prevent High Fc Filter	<div style="display: flex; justify-content: space-between; font-size: 0.8em;"> <span>V/f</span> <span>CL-V/f</span> <span>OLV</span> <span>CLV</span> <span>AOLV</span> <span>OLV/PM</span> <span>AOLV/PM</span> <span>CLV/PM</span> <span>EZOLV</span> </div> <p>Sets the responsiveness of the hunting prevention function. Usually it is not necessary to change this setting.</p>	500 ms (0 - 1000 ms)

When  $n1-01 = 2$  [*Hunting Prevention Selection = Enabled (High Carrier Frequency)*], if the motor stalls when the load changes, increase the value set in this parameter in 100 ms increments.

If you set  $n1-01 = 2$  and you cannot suppress hunting, increase the value set in this parameter in 100 ms increments.

## ◆ n2: Auto Freq Regulator (AFR)

The speed feedback detection reduction function (or AFR: Automatic Frequency Regulator) helps the speed become stable when you suddenly apply or remove a load.

### Note:

Before you change  $n2-xx$  parameters, do one of these procedures:

- Set the motor parameters and V/f pattern correctly.
- Do Rotational Auto-Tuning.

## ■ n2-01: Automatic Freq Regulator Gain

No. (Hex.)	Name	Description	Default (Range)
n2-01 (0584)	Automatic Freq Regulator Gain	<div style="display: flex; justify-content: space-between; font-size: 0.8em;"> <span>V/f</span> <span>CL-V/f</span> <span>OLV</span> <span>CLV</span> <span>AOLV</span> <span>OLV/PM</span> <span>AOLV/PM</span> <span>CLV/PM</span> <span>EZOLV</span> </div> <p>Sets the gain of the AFR function as a magnification value. Usually it is not necessary to change this setting.</p>	1.00 (0.00 - 10.00)

Adjust this parameter in these conditions:

- If hunting or oscillation occurs with light loads, increase the setting value in 0.05-unit increments and examine the response.
- When torque is not sufficient with heavy loads or to make the torque or speed response better, decrease the setting value in 0.05-unit increments and examine the response.

## ■ n2-02: Automatic Freq Regulator Time 1

No. (Hex.)	Name	Description	Default (Range)
n2-02 (0585)	Automatic Freq Regulator Time 1	<div style="display: flex; justify-content: space-between; font-size: 0.8em;"> <span>V/f</span> <span>CL-V/f</span> <span>OLV</span> <span>CLV</span> <span>AOLV</span> <span>OLV/PM</span> <span>AOLV/PM</span> <span>CLV/PM</span> <span>EZOLV</span> </div> <p>Sets the time constant that sets the rate of change for the AFR function. Usually it is not necessary to change this setting.</p>	50 ms (0 - 2000 ms)

Adjust this parameter in these conditions:

- If there is hunting or oscillation with a light load, increase the setting value in 50 ms increments and examine the response. If the load inertia is large, increase the setting value in 50 ms increments and examine the response.
- If torque is not sufficient with a heavy load or if you must increase torque or speed responsiveness, decrease the setting value in 10 ms increments and examine the response.

**Note:**

- Set  $n2-02 \leq n2-03$  [Automatic Freq Regulator Time 2]. If  $n2-02 > n2-03$ , the drive will detect *oPE08* [Parameter Selection Error].
- When you change the value in  $n2-02$ , also change the value in  $C4-02$  [Torque Compensation Delay Time] by the same ratio.

■ **n2-03: Automatic Freq Regulator Time 2**

No. (Hex.)	Name	Description	Default (Range)
n2-03 (0586)	Automatic Freq Regulator Time 2	<div style="display: flex; justify-content: space-between; font-size: small;"> <span>V/f</span> <span>CL-V/f</span> <span style="background-color: #cccccc;">OLV</span> <span>CLV</span> <span>AOLV</span> <span>OLV/PM</span> <span>AOLV/PM</span> <span>CLV/PM</span> <span>EZOLV</span> </div> <p>Sets the time constant that sets the speed difference of the AFR function. Use this parameter for speed searches or regeneration. Usually it is not necessary to change this setting.</p>	750 ms (0 - 2000 ms)

Adjust this parameter in these conditions:

- If the drive detects *ov* [Overvoltage] when acceleration stops under high-inertia loads, increase the setting value in 50 ms increments. If the drive detects *ov* when the load changes suddenly, increase the setting value in 50 ms increments.
- To increase the responsiveness of torque and speed, decrease the setting value in 10 ms increments and examine the response.

**Note:**

- Set  $n2-02 \leq n2-03$  [Automatic Freq Regulator Time 2]. If  $n2-02 > n2-03$ , the drive will detect *oPE08* [Parameter Selection Error].
- When you change the value in  $n2-03$ , also change the value in  $C4-06$  [Motor 2 Torque Comp Delay Time] by the same ratio.

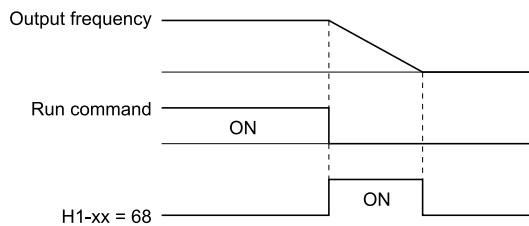
◆ **n3: High Slip Braking (HSB) and Overexcitation Braking**

$n3$  parameters configure High Slip Braking and Overexcitation Deceleration.

■ **High Slip Braking**

High slip braking quickly decelerates motors without braking resistors.

This lets you stop a motor more quickly than with the ramp to stop processes. This function is best for applications that do not frequently stop the motor, for example the fast stop function for high-inertia loads. Braking starts when the MFDDI for *High Slip Braking (HSB) Activate* [ $H1-xx = 68$ ] activates.



**Figure 11.147 High Slip Braking Time Chart**

An induction motor is necessary to use high slip braking.

Set  $A1-02$  [Control Method Selection] to one of these values to enable high slip braking:

- 0 [V/f Control]
- 1 [V/f Control with Encoder]

**Principles of Operation**

HSB increases motor slip by significantly decreasing the frequency supplied to the motor at the same time that deceleration starts. A large quantity of current flows through the motor to increase the motor loss, and the motor decelerates while the motor windings consume the regenerative energy.

The drive keeps the motor current at a constant level during deceleration to prevent overvoltage and do automatic braking and it also keeps a slip level that causes the maximum quantity of deceleration torque.

### High Slip Braking Precautions

- Do not use the high slip braking function in these applications:
  - Frequent deceleration
  - Deceleration time differences
  - Continuous regenerative loads
  - It is necessary to accelerate again during deceleration
- Motor loss increases during high slip braking. Use this function when the duty time factor is 5% ED or less and the braking time is 90 seconds or less. The load inertia and motor characteristics have an effect on the braking time.
- The drive ignores the configured deceleration time during high slip braking. To stop motors in the configured deceleration time, set  $L3-04 = 4$  [*Stall Prevention during Decel = Overexcitation/High Flux*].
- You cannot use high slip braking to decelerate deceleration at user-defined speeds. To decelerate at user-defined speeds, use the overexcitation deceleration function.
- You cannot accelerate the motor again during high slip braking until you fully stop the motor and input the Run command again.
- You cannot use high slip braking and the KEB Ride-Thru function at the same time. If you enable those two functions, the drive will detect *oPE03* [*Multi-Function Input Setting Err*].

### ■ Overexcitation Deceleration

Overexcitation deceleration quickly decelerates motors without braking resistors. This lets you stop a motor more quickly than with the ramp to stop processes.

Overexcitation deceleration increases excitation current during deceleration to cause a large quantity of braking torque through motor overexcitation. You can set the deceleration speed to adjust the deceleration time for overexcitation deceleration.

Overexcitation deceleration lets you accelerate the motor again during deceleration.

Enter the Run command during overexcitation deceleration to cancel overexcitation deceleration and accelerate the drive to the specified speed.

To enable this function, set  $L3-04 = 4, 5$  [*Stall Prevention during Decel = Overexcitation/High Flux, Overexcitation/High Flux 2*].

When  $L3-04 = 4$ , the motor will decelerate for the deceleration time set in  $C1-02$ ,  $C1-04$ ,  $C1-06$ , or  $C1-08$ . If the drive detects *ov* [*Overvoltage*], increase the deceleration time.

When  $L3-04 = 5$ , the drive uses the value in  $C1-02$ ,  $C1-04$ ,  $C1-06$ , or  $C1-08$  to decelerate and it adjusts the deceleration rate to keep the DC bus voltage at the level set in  $L3-17$  [*DC Bus Regulation Level*]. The load inertia and motor characteristics have an effect on the braking time.

#### Notes on Overexcitation Deceleration

- Do not use Overexcitation Deceleration with a braking resistor.
- Do not use Overexcitation Deceleration for these applications. Connect a braking resistor to the drive as an alternative to Overexcitation Deceleration.
  - Frequent sudden decelerations
  - Continuous regenerative loads
  - Low inertia machines
  - Machines that have no tolerance for torque ripples
- Motor loss increases during overexcitation deceleration. Use this function when the duty time factor is 5% ED or less and the braking time is 90 seconds or less. The load inertia and motor characteristics have an effect on the braking time. You can use overexcitation deceleration in OLV control and CLV control, but those control methods decrease the precision of torque control and braking efficiency. Use V/f control for the best results.
- The drive disables these functions during braking with Overexcitation Deceleration 2:
  - Hunting Prevention Function (V/f Control)
  - Torque Limit Speed Control (OLV Control)

### ■ n3-01: HSB Deceleration Frequency Width

No. (Hex.)	Name	Description	Default (Range)
n3-01 (0588) Expert	HSB Deceleration Frequency Width	<b>V/f</b> <b>CL-V/f</b> <b>OLV</b> <b>CLV</b> <b>AOLV</b> <b>OLV/PM</b> <b>AOLV/PM</b> <b>CLV/PM</b> <b>EZOLV</b> Sets how much the drive lowers the output frequency during high-slip braking as a percentage where <i>E1-04 [Maximum Output Frequency]</i> = 100%.	5% (1 - 20%)

When you must detect *ov [DC Bus Overvoltage]* during high-slip braking, set this parameter to a large value.

### ■ n3-02: HSB Current Limit Level

No. (Hex.)	Name	Description	Default (Range)
n3-02 (0589) Expert	HSB Current Limit Level	<b>V/f</b> <b>CL-V/f</b> <b>OLV</b> <b>CLV</b> <b>AOLV</b> <b>OLV/PM</b> <b>AOLV/PM</b> <b>CLV/PM</b> <b>EZOLV</b> Sets the maximum current output during high-slip braking as a percentage where <i>E2-01 [Motor Rated Current (FLA)]</i> = 100%. Also set the current suppression to prevent exceeding drive overload tolerance.	Determined by C6-01, L8-38 (0 - 200%)

When you decrease the setting value for current suppression, it will make the deceleration time longer.

- When you must detect *ov [DC Bus Overvoltage]* during high-slip braking, set this parameter to a low value.
- If the motor current increases during high-slip braking, decrease the setting value to prevent burn damage in the motor.
- The overload tolerance for the drive is 150% for Heavy Duty Rating (HD) and 110% for Normal Duty Rating (ND).

### ■ n3-03: HSB Dwell Time at Stop

No. (Hex.)	Name	Description	Default (Range)
n3-03 (058A) Expert	HSB Dwell Time at Stop	<b>V/f</b> <b>CL-V/f</b> <b>OLV</b> <b>CLV</b> <b>AOLV</b> <b>OLV/PM</b> <b>AOLV/PM</b> <b>CLV/PM</b> <b>EZOLV</b> Sets the dwell time, a length of time when high-slip braking is ending and during which the motor speed decreases and runs at a stable speed. For a set length of time, the drive will hold the actual output frequency at the minimum output frequency set in <i>E1-09</i> .	1.0 s (0.0 - 10.0 s)

If there is too much inertia or when the motor is coasting to a stop after high-slip braking is complete, increase the setting value. If the setting value is too low, machine inertia can cause the motor to rotate after high-slip braking is complete.

### ■ n3-04: HSB Overload Time

No. (Hex.)	Name	Description	Default (Range)
n3-04 (058B) Expert	HSB Overload Time	<b>V/f</b> <b>CL-V/f</b> <b>OLV</b> <b>CLV</b> <b>AOLV</b> <b>OLV/PM</b> <b>AOLV/PM</b> <b>CLV/PM</b> <b>EZOLV</b> Sets the time used to detect <i>oL7 [High Slip Braking Overload]</i> , which occurs when the output frequency does not change during high-slip braking. Usually it is not necessary to change this setting.	40 s (30 - 1200 s)

If a force on the load side is rotating the motor or if there is too much load inertia connected to the motor, the drive will detect *oL7*.

The current flowing to the motor from the load can overheat the motor and cause burn damage to the motor. Set this parameter to prevent burn damage to the motor.

### ■ n3-13: OverexcitationBraking (OEB) Gain

No. (Hex.)	Name	Description	Default (Range)
n3-13 (0531)	OverexcitationBraking (OEB) Gain	<b>V/f</b> <b>CL-V/f</b> <b>OLV</b> <b>CLV</b> <b>AOLV</b> <b>OLV/PM</b> <b>AOLV/PM</b> <b>CLV/PM</b> <b>EZOLV</b> Sets the gain value that the drive multiplies by the V/f pattern output value during overexcitation deceleration to calculate the overexcitation level.	1.10 (1.00 - 1.40)

The V/f pattern output value goes back to its usual level after the motor stops or accelerates again to the frequency reference speed.



The best value of this parameter changes when the flux saturation characteristics of the motor change.

- Gradually increase the value of *n3-13* to 1.25 or 1.30 to increase the braking power of Overexcitation Deceleration. If the gain is too much, the motor can have flux saturation and cause a large quantity of current to flow. This can increase the deceleration time.
- Decrease the setting value if flux saturation causes overcurrent. If you increase the setting value, the drive can detect *oC* [Overcurrent], *oL1* [Motor Overload], and *oL2* [Drive Overload]. Decrease the value of *n3-21* [HSB Current Suppression Level] to prevent *oC* and *oL*.
- Regular use of overexcitation deceleration or extended periods of overexcitation deceleration can increase internal motor temperatures. Decrease the setting value in these conditions.
- If *ov* [Overvoltage] occurs, increase the deceleration time.

### ■ n3-14: OEB High Frequency Injection

No. (Hex.)	Name	Description	Default (Range)
n3-14 (0532) Expert	OEB High Frequency Injection	<input type="checkbox"/> V/f <input type="checkbox"/> CL-V/f <input type="checkbox"/> OLV <input type="checkbox"/> CLV <input type="checkbox"/> AOLV <input type="checkbox"/> OLV/PM <input type="checkbox"/> AOLV/PM <input type="checkbox"/> CLV/PM <input type="checkbox"/> EZOLV Sets the function that injects harmonic signals during overexcitation deceleration.	0 (0, 1)

Enable this parameter to set a shorter deceleration time.

#### Note:

- If you frequently use overexcitation deceleration on a motor, the motor loss will increase the risk of burn damage.
- When you set this parameter to 1, the motor can make a loud excitation sound during overexcitation deceleration. If the excitation sound is unwanted, set this parameter to 0 to disable the function.

#### 0 : Disabled

#### 1 : Enabled

The drive injects harmonic signals at the time of overexcitation deceleration. You can decrease the deceleration time because motor loss increases.

### ■ n3-21: HSB Current Suppression Level

No. (Hex.)	Name	Description	Default (Range)
n3-21 (0579)	HSB Current Suppression Level	<input type="checkbox"/> V/f <input type="checkbox"/> CL-V/f <input type="checkbox"/> OLV <input type="checkbox"/> CLV <input type="checkbox"/> AOLV <input type="checkbox"/> OLV/PM <input type="checkbox"/> AOLV/PM <input type="checkbox"/> CLV/PM <input type="checkbox"/> EZOLV Sets the upper limit of the current that is suppressed at the time of overexcitation deceleration, where the drive rated current = 100% value.	100% (0 - 150%)

If flux saturation during Overexcitation Deceleration makes the motor current become more than the value set in this parameter, the drive will automatically decrease the overexcitation gain. If *oC* [Overcurrent], *oL1* [Motor Overload], or *oL2* [Drive Overloaded] occur during overexcitation deceleration, decrease the setting value.

If repetitive or long overexcitation deceleration cause the motor to overheat, decrease the setting value.

### ■ n3-23: Overexcitation Braking Operation

No. (Hex.)	Name	Description	Default (Range)
n3-23 (057B)	Overexcitation Braking Operation	<input type="checkbox"/> V/f <input type="checkbox"/> CL-V/f <input type="checkbox"/> OLV <input type="checkbox"/> CLV <input type="checkbox"/> AOLV <input type="checkbox"/> OLV/PM <input type="checkbox"/> AOLV/PM <input type="checkbox"/> CLV/PM <input type="checkbox"/> EZOLV Sets the direction of motor rotation where the drive will enable overexcitation.	0 (0 - 2)

#### 0 : Disabled

#### 1 : Enabled Only when Rotating FWD

#### 2 : Enabled Only when Rotating REV

#### Note:

When *n3-23* = 1, 2, the drive enables overexcitation only in the direction of motor rotation in which a regenerative load is applied. Increased motor loss can decrease *ov* [Overvoltage] faults.

## ◆ n4: Adv Open Loop Vector Tune

The following explains how to make special adjustments for *Advanced Open Loop Vector* [*A1-02* = 4].

- First, perform Rotational Auto-Tuning.
- Operation that fluctuates around zero speed cannot be carried out when there is a load. For applications of this sort, set  $AI-02 = 3$  [*Open Loop Vector*].
- The tolerance of regenerative torque at low speeds is diminished. If regenerative torque is required in the low speed range, set  $AI-02 = 3$ .
- This cannot be used for elevators or similar applications. There is a risk that the load could slip.

■ **n4-60: Motoring Low Speed Comp Gain**

No. (Hex.)	Name	Description	Default (Range)
n4-60 (1B80)	Motoring Low Speed Comp Gain	<div style="display: flex; justify-content: space-between; font-size: small;"> <span>V/f</span> <span>CL-V/f</span> <span>OLV</span> <span>CLV</span> <span style="background-color: #cccccc;">AOLV</span> <span>OLV/PM</span> <span>AOLV/PM</span> <span>CLV/PM</span> <span>EZOLV</span> </div> <p>Sets a compensation gain to improve the control qualities for motoring loads in the low speed range.</p>	100.0% (50.0 - 200.0%)

**Note:**

- To increase the torque precision in the motoring direction when you operate at low speeds, do Stationary Auto-Tuning for Line-to-Line Resistance only, or increase the value of this parameter in 5% increments.
- If the output frequency changes when you operate at low speeds, do Stationary Auto-Tuning for Line-to-Line Resistance only. If it is not better, increase this parameter in 10% increments. The recommended setting is 50% to 100%.

■ **n4-61: Low Speed Comp Frequency Level**

No. (Hex.)	Name	Description	Default (Range)
n4-61 (1B81)	Low Speed Comp Frequency Level	<div style="display: flex; justify-content: space-between; font-size: small;"> <span>V/f</span> <span>CL-V/f</span> <span>OLV</span> <span>CLV</span> <span style="background-color: #cccccc;">AOLV</span> <span>OLV/PM</span> <span>AOLV/PM</span> <span>CLV/PM</span> <span>EZOLV</span> </div> <p>Sets a frequency at which the settings for <i>n4-60 [Motoring Low Speed Comp Gain]</i>, <i>n4-62 [Regen Low Speed Comp Gain]</i> are enabled. When the output frequency &lt; <i>n4-61</i>, the drive adjusts the torque to agree with the settings for <i>n4-60</i> and <i>n4-62</i>. Usually it is not necessary to change this setting.</p>	6.00 Hz (0.50 - 12.00 Hz)

■ **n4-62: Regen Low Speed Comp Gain**

No. (Hex.)	Name	Description	Default (Range)
n4-62 (1B82)	Regen Low Speed Comp Gain	<div style="display: flex; justify-content: space-between; font-size: small;"> <span>V/f</span> <span>CL-V/f</span> <span>OLV</span> <span>CLV</span> <span style="background-color: #cccccc;">AOLV</span> <span>OLV/PM</span> <span>AOLV/PM</span> <span>CLV/PM</span> <span>EZOLV</span> </div> <p>Sets a compensation gain to improve the control qualities for regenerative loads in the low speed range.</p>	100.0% (50.0 - 200.0%)

**Note:**

If you do not apply a regenerative load when you operate at low speeds, do stationary Auto-Tuning for Line-to-Line Resistance only. If it is not better, increase this parameter in 5% increments. The recommended setting is 100% to 150%. If you set this parameter too high, the drive will detect *CF [Control Fault]* at stop.

■ **n4-63: Speed EstimateResponse@High Freq**

No. (Hex.)	Name	Description	Default (Range)
n4-63 (1B83)	Speed EstimateResponse@High Freq	<div style="display: flex; justify-content: space-between; font-size: small;"> <span>V/f</span> <span>CL-V/f</span> <span>OLV</span> <span>CLV</span> <span style="background-color: #cccccc;">AOLV</span> <span>OLV/PM</span> <span>AOLV/PM</span> <span>CLV/PM</span> <span>EZOLV</span> </div> <p>Sets the responsiveness of the speed estimation in high speed ranges, where the output frequency is <math>\geq n4-67</math> [<i>Estimate Gain Switchover Freq.</i>]</p>	60.0 (0.1 - 150.0)

If better response of speed estimation is necessary, or if the motor oscillates, or if there is a large quantity of torque ripple, increase the setting value in 10.0 unit increments. If this does not make it better, decrease the setting value in 10.0 unit increments.

**Note:**

Do rotational Auto-Tuning before you adjust *n4-63*, *n4-64 [Speed Estimate Response@Low Freq]*, *n4-65 [Flux Estimate Response@High Freq]*, and *n4-66 [Flux Estimate Response @Low Freq]*.

### ■ n4-64: Speed Estimate Response@Low Freq

No. (Hex.)	Name	Description	Default (Range)
n4-64 (1B84)	Speed Estimate Response@Low Freq	<div style="display: flex; justify-content: space-between; font-size: 0.8em; margin-bottom: 5px;"> <span>V/f</span> <span>CL-V/f</span> <span>OLV</span> <span>CLV</span> <span style="background-color: #cccccc;">AOLV</span> <span>OLV/PM</span> <span>AOLV/PM</span> <span>CLV/PM</span> <span>EZOLV</span> </div> Sets the responsiveness of the speed estimation in low speed ranges, where $0 \leq$ the output frequency, which is $< n4-67$ [Estimate Gain Switchover Freq].	60.0 (0.1 - 150.0)

If better response of speed estimation is necessary, or if the motor oscillates, or if there is a large quantity of torque ripple, increase the setting value in 10.0 unit increments.

**Note:**

Do rotational Auto-Tuning before you adjust *n4-63* [Speed EstimateResponse@High Freq], *n4-64*, *n4-65* [Flux Estimate Response@High Freq], and *n4-66* [Flux Estimate Response @Low Freq].

### ■ n4-65: Flux Estimate Response@High Freq

No. (Hex.)	Name	Description	Default (Range)
n4-65 (1B85)	Flux Estimate Response@High Freq	<div style="display: flex; justify-content: space-between; font-size: 0.8em; margin-bottom: 5px;"> <span>V/f</span> <span>CL-V/f</span> <span>OLV</span> <span style="background-color: #cccccc;">CLV</span> <span style="background-color: #cccccc;">AOLV</span> <span>OLV/PM</span> <span>AOLV/PM</span> <span>CLV/PM</span> <span>EZOLV</span> </div> Sets the responsiveness of the magnetic flux estimation in high speed ranges, where the output frequency is $\geq n4-67$ [Estimate Gain Switchover Freq]. Usually it is not necessary to change this setting.	0.90 (0.50 - 1.50)

If the drive detects *oS* [Overspeed] in no-load conditions, or if the speed does not become stable in the high speed range, increase or decrease the setting value in 0.05 unit increments.

### ■ n4-66: Flux Estimate Response @Low Freq

No. (Hex.)	Name	Description	Default (Range)
n4-66 (1B86)	Flux Estimate Response @Low Freq	<div style="display: flex; justify-content: space-between; font-size: 0.8em; margin-bottom: 5px;"> <span>V/f</span> <span>CL-V/f</span> <span>OLV</span> <span style="background-color: #cccccc;">CLV</span> <span style="background-color: #cccccc;">AOLV</span> <span>OLV/PM</span> <span>AOLV/PM</span> <span>CLV/PM</span> <span>EZOLV</span> </div> Sets the responsiveness of the magnetic flux estimation in low speed ranges, where $0 \leq$ the output frequency, which is $< n4-67$ [Estimate Gain Switchover Freq]. Usually it is not necessary to change this setting.	0.90 (0.50 - 1.50)

If the drive detects *oS* [Overspeed] in no-load conditions, or if the speed does not become stable in the low speed range, increase or decrease the setting value in 0.05 unit increments.

### ■ n4-67: Estimate Gain Switchover Freq

No. (Hex.)	Name	Description	Default (Range)
n4-67 (1B87)	Estimate Gain Switchover Freq	<div style="display: flex; justify-content: space-between; font-size: 0.8em; margin-bottom: 5px;"> <span>V/f</span> <span>CL-V/f</span> <span>OLV</span> <span style="background-color: #cccccc;">CLV</span> <span style="background-color: #cccccc;">AOLV</span> <span>OLV/PM</span> <span>AOLV/PM</span> <span>CLV/PM</span> <span>EZOLV</span> </div> Sets the switching frequency for estimation gain for these parameters: <i>n4-63</i> [Speed EstimateResponse@High Freq] <i>n4-64</i> [Speed Estimate Response@Low Freq] <i>n4-65</i> [Flux Estimate Response@High Freq] <i>n4-66</i> [Flux Estimate Response @Low Freq]	6.00 Hz (0.00 - E1-04)

If the output frequency  $> n4-67$ , the drive will select *n4-63* and *n4-65*. If the output frequency  $< n4-67$ , the drive will select *n4-64* and *n4-66*.

### ■ n4-68: Speed Estimation Filter Time

No. (Hex.)	Name	Description	Default (Range)
n4-68 (1B88)	Speed Estimation Filter Time	<div style="display: flex; justify-content: space-between; font-size: 0.8em; margin-bottom: 5px;"> <span>V/f</span> <span>CL-V/f</span> <span>OLV</span> <span>CLV</span> <span style="background-color: #cccccc;">AOLV</span> <span>OLV/PM</span> <span>AOLV/PM</span> <span>CLV/PM</span> <span>EZOLV</span> </div> Sets the primary delay time constant for the speed estimation value. Usually it is not necessary to change this setting.	0.001 s (0.001 - 0.010 s)

If the motor speed oscillates in the high speed range, set the value to 0.010 s.

### ■ n4-69: Flux Control Response

No. (Hex.)	Name	Description	Default (Range)
n4-69 (1B89)	Flux Control Response	<div style="display: flex; justify-content: space-between; font-size: 0.8em; margin-bottom: 5px;"> <span>V/f</span> <span>CL-V/f</span> <span>OLV</span> <span>CLV</span> <span style="background-color: #cccccc;">AOLV</span> <span>OLV/PM</span> <span>AOLV/PM</span> <span>CLV/PM</span> <span>EZOLV</span> </div> Unifies control of magnetic flux to make motor vibrations more stable.	1.00 (0.00 - 60.00)

If step-out occurs when the load changes, decrease the setting value in 1.00 increments.

**Note:**

If heavy loads decrease motor speed, increase the setting value in 1.00 increments. If it does not get better, increase *n4-74 [Limit of Flux Loop]* in 20% increments.

### ■ n4-70: Speed Command Comp @ Low Freq

No. (Hex.)	Name	Description	Default (Range)
n4-70 (1B8A)	Speed Command Comp @ Low Freq	<div style="display: flex; justify-content: space-between; font-size: 0.8em; margin-bottom: 5px;"> <span>V/f</span> <span>CL-V/f</span> <span>OLV</span> <span>CLV</span> <span style="background-color: #cccccc;">AOLV</span> <span>OLV/PM</span> <span>AOLV/PM</span> <span>CLV/PM</span> <span>EZOLV</span> </div> Sets the function to make the drive more stable when operating at low speeds. Usually it is not necessary to change this setting.	0.60 Hz (0.00 - 1.50 Hz)

This function makes the control more stable when operating at low speeds. Increase the setting in 0.3 Hz increments at the time of low-speed references with no load.

**Note:**

If you increase this parameter to make the speed references for low speeds more stable, it can make the speed control less accurate.

### ■ n4-72: Speed Feedback Mode

No. (Hex.)	Name	Description	Default (Range)
n4-72 (1B8C)	Speed Feedback Mode	<div style="display: flex; justify-content: space-between; font-size: 0.8em; margin-bottom: 5px;"> <span>V/f</span> <span>CL-V/f</span> <span>OLV</span> <span>CLV</span> <span style="background-color: #cccccc;">AOLV</span> <span>OLV/PM</span> <span>AOLV/PM</span> <span>CLV/PM</span> <span>EZOLV</span> </div> Sets the requirement for an encoder option when <i>A1-02 = 4 [Control Method Selection = Advanced Open Loop Vector]</i> .	0 (0, 1)

You can connect a PG-B3 or PG-X3 encoder option in AOLV control. You can use the encoder option for better speed control precision.

**Note:**

- When you use an encoder option in AOLV control to operate machinery, specialized tuning of the drive can be necessary. You should usually set *A1-02 = 3 [Control Method Selection = Closed Loop Vector]* when you use an encoder option.
- When you set this parameter to 1, also set the number of PG pulses in *F1-01 [Encoder 1 Pulse Count (PPR)]*.

#### 0 : Without Encoder

#### 1 : With Encoder

### ■ n4-73: PGo Recovery Selection

No. (Hex.)	Name	Description	Default (Range)
n4-73 (1B8D)	PGo Recovery Selection	<div style="display: flex; justify-content: space-between; font-size: 0.8em; margin-bottom: 5px;"> <span>V/f</span> <span>CL-V/f</span> <span>OLV</span> <span>CLV</span> <span style="background-color: #cccccc;">AOLV</span> <span>OLV/PM</span> <span>AOLV/PM</span> <span>CLV/PM</span> <span>EZOLV</span> </div> Sets the restart mode to Without Encoder Mode or the With Encoder Mode when an encoder is disconnected.	0 (0, 1)

Set *A1-02 = 4 [Control Method Selection = Advanced Open Loop Vector]* and *n4-72 = 1 [Speed Feedback Mode = With Encoder]* to use this parameter.

Parameter *F1-02 [Encoder Signal Loss Detect Sel]*, sets the drive response when the drive detects a disconnected encoder. This parameter sets the drive to start up in the Without Encoder Mode or With Encoder Mode when the drive detects *PGo [Encoder (PG) Feedback Loss]*.

**Note:**

A PG-B3 encoder option is necessary to use this parameter. When you use a PG-X3 option, it is not necessary to set this parameter.

If the drive detects *PGo*, de-energize the drive and examine the wiring for the encoder.

#### 0 : Without Encoder

#### 1 : With Encoder

■ n4-74: Limit of Flux Loop

No. (Hex.)	Name	Description	Default (Range)
n4-74 (1B8E)	Limit of Flux Loop	<div style="display: flex; justify-content: space-between; font-size: small;"> <span>V/f</span> <span>CL-V/f</span> <span>OLV</span> <span>CLV</span> <span style="background-color: #cccccc;">AOLV</span> <span>OLV/PM</span> <span>AOLV/PM</span> <span>CLV/PM</span> <span>EZOLV</span> </div> Sets the control level for flux loop control output.	160% (100 - 500%)

If the torque is not sufficient because of 100% or more loads, increase the setting value in 20% increments. If the setting is too high, overexcitation could occur and overheat the motor.

◆ n5: Feed Forward Control

Feed forward control increases the responsiveness of acceleration and deceleration as specified by the speed reference.

Increase the values set in C5-01 and C5-03 [ASR Proportional Gain] to apply feed forward control to machines that have low rigidity and are possible to have hunting and vibration or to machines that have a large quantity of inertia. When you use this function in CLV control, it also helps prevent overshoot. Refer to Figure 11.148 for more information. Refer to Figure 11.149 for more information about parameters related to feed forward control.

Set A1-02 [Control Method Selection] is set to one of these values to enable feed forward control:

- 3: Closed Loop Vector Control
- 4: Advanced OpenLoop Vector Control
- 6: PM Advanced Open Loop Vector
- 7: PM Closed Loop Vector Control

**Note:**

- You cannot use feed forward control to increase responsiveness in applications where you apply loads externally during run at constant speed.
- When you use the Droop control function, set n5-01 = 0 [Feed Forward Control Selection = Disabled].
- You cannot use feed forward control with motor 2.

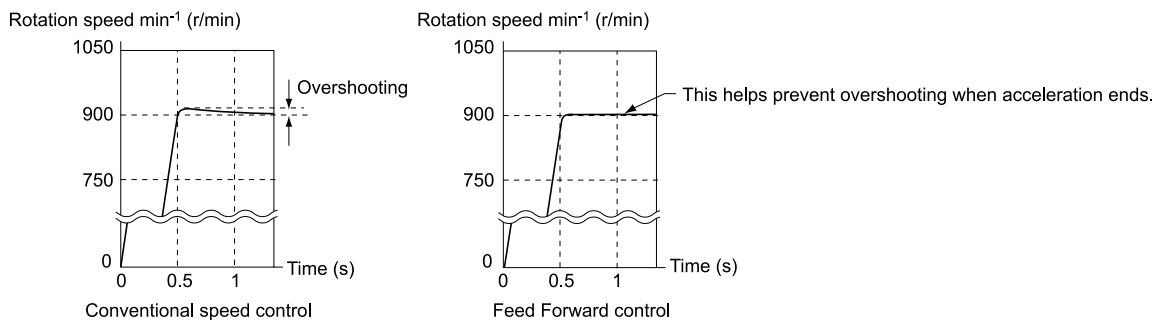


Figure 11.148 Suppress Overshooting with Feed Forward Control

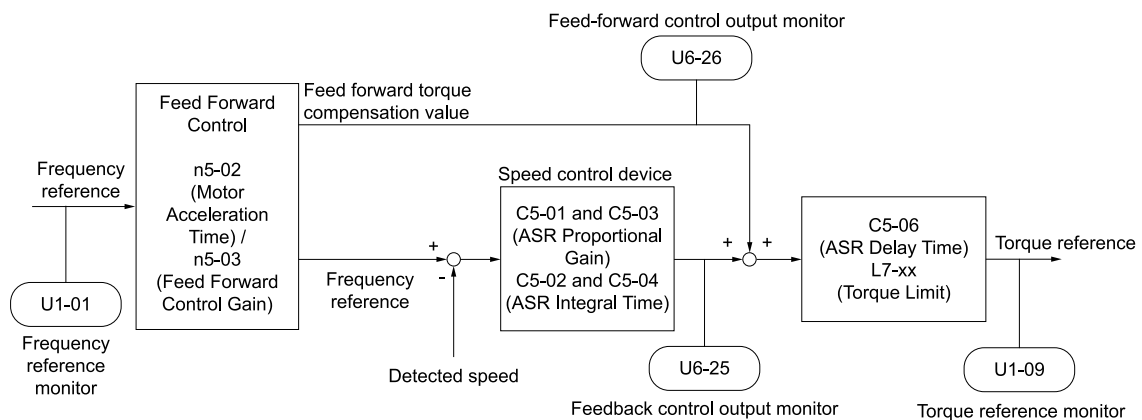


Figure 11.149 Configure Feed Forward Control

■ Before You Use Feed Forward Control

Do one of these procedures before you use feed forward control.

- Run Auto-Tuning to set motor parameters.  
When you cannot do Auto-Tuning, manually set motor parameters with the information on the motor nameplate or test reports. Set the *E2 parameters* for induction motors. Set the *E5 parameters* for PM motors.
- Set *C5 parameters* [*Automatic Speed Regulator (ASR)*] individually to adjust the speed control loop (ASR).
- If you can connect a motor to a machine and rotate it during Auto-Tuning, do Inertia Tuning.  
The drive automatically adjusts feed forward parameters during Inertia Tuning.
- If you cannot do Inertia Tuning, refer to [Figure 11.149](#) and set the parameters related to feed forward control individually.

■ **n5-01: Feed Forward Control Selection**

No. (Hex.)	Name	Description	Default (Range)
n5-01 (05B0)	Feed Forward Control Selection	<div style="display: flex; justify-content: space-between; font-size: small;"> <span>V/f</span> <span>CL-V/f</span> <span>OLV</span> <span><b>CLV</b></span> <span>AOLV</span> <span>OLV/PM</span> <span>AOLV/PM</span> <span>CLV/PM</span> <span>EZOLV</span> </div> Sets the feed forward function.	0 (0, 1)

**0 : Disabled**

**1 : Enabled**

■ **n5-02: Motor Inertia Acceleration Time**

No. (Hex.)	Name	Description	Default (Range)
n5-02 (05B1)	Motor Inertia Acceleration Time	<div style="display: flex; justify-content: space-between; font-size: small;"> <span>V/f</span> <span>CL-V/f</span> <span>OLV</span> <span><b>CLV</b></span> <span>AOLV</span> <span>OLV/PM</span> <span>AOLV/PM</span> <span>CLV/PM</span> <span>EZOLV</span> </div> Sets the length of time for the motor to accelerate from the stopped to the maximum frequency with a single motor at the rated torque. Inertia Tuning automatically sets the motor acceleration time.	Determined by C6-01, E5-01, and o2-04 (0.001 - 10.000 s)

If you cannot do Inertia Tuning, calculate the motor acceleration time as shown here or measure the motor acceleration time and set *n5-02* to this value.

**Calculate the Motor Acceleration Time**

Use this formula to find the motor acceleration time:

$$n5-02 = \frac{2\pi \cdot J_{\text{Motor}} \cdot n_{\text{rated}}}{60 \cdot T_{\text{rated}}}$$

- $J_{\text{Motor}}$  = Moment of inertia of motor (kg m<sup>2</sup>)
- $n_{\text{rated}}$  = Motor rated speed (min<sup>-1</sup>, r/min)
- $T_{\text{rated}}$  = Motor rated torque (N m)

You can also use this formula to find the motor acceleration time:

$$n5-02 = \frac{4\pi \cdot J_{\text{Motor}} \cdot f_{\text{rated}}}{p \cdot T_{\text{rated}}}$$

- $f_{\text{rated}}$  = Motor rated frequency (Hz)
- $p$  = Number of motor poles

**Calculate the Motor Acceleration Time**

Use this procedure to calculate the motor acceleration time:

1. Use *A1-02* [*Control Method Selection*] to set the control method.
2. Disconnect the motor and load.
3. Run Auto-Tuning to set motor parameters.  
When you cannot do Auto-Tuning, manually set motor parameters with the information on the motor nameplate or test reports. Set the *E2 parameters* for induction motors. Set the *E5 parameters* for PM motors.
4. Set *C5 parameters* [*Automatic Speed Regulator (ASR)*].
5. Set *C1-01* [*Acceleration Time 1*] = 0.
6. Set *L7-01* [*Forward Torque Limit*] to 100%.
7. Set the frequency reference to the same value as the motor rated speed.
8. Measure the length of time for the motor to reach the rated speed.  
Show *U1-05* [*Motor Speed*] on the keypad and enter the Run command (forward run).
9. Stop the motor.

10. Set *n5-02* to the measured motor acceleration time value.

Reset all of the parameters that you changed to the previous setting values.

### ■ n5-03: Feed Forward Control Gain

No. (Hex.)	Name	Description	Default (Range)
n5-03 (05B2)	Feed Forward Control Gain	<span>V/f</span> <span>CL-V/f</span> <span>OLV</span> <span>CLV</span> <span>AOLV</span> <span>OLV/PM</span> <span>AOLV/PM</span> <span>CLV/PM</span> <span>EZOLV</span> Sets the ratio between load inertia and motor inertia. Inertia Tuning automatically sets the Feedforward Control Gain value.	1.00 (0.00 - 100.00)

When you cannot do Inertia Tuning, use this procedure to set *n5-03*:

1. Set *n5-02* [*Motor Inertia Acceleration Time*].
2. Connect the motor and load.
3. Set *C1-01* [*Acceleration Time 1*] = 0.
4. Use *L7-01* to *L7-04* [*Torque Limit*] to set the expected test run torque limit levels.
5. Set the frequency reference as specified by the high speed range of the machine.
6. Measure the length of time for the motor to reach the command reference speed. Show *U1-05* [*Motor Speed*] on the keypad and enter the Run command.
7. Stop the motor.
8. Replace the values in the this formula and set *n5-03* to the value of the formula.

$$n5-03 = \frac{t_{\text{accel}} \cdot T_{\text{Lim\_Test}} \cdot f_{\text{rated}}}{n5-02 \cdot f_{\text{ref\_Test}} \cdot 100} - 1$$

- $t_{\text{accel}}$  = Acceleration time (s)
- $f_{\text{rated}}$  = Motor rated frequency (Hz)
- $T_{\text{Lim\_Test}}$  = Test run torque limit (%)
- $f_{\text{ref\_Test}}$  = Test run frequency reference (Hz)

**WARNING!** *Sudden Movement Hazard. Machinery can accelerate suddenly. Do not use this function with machinery that must not accelerate suddenly. Failure to obey can cause death or serious injury.*

Reset all of the parameters that you changed to the previous setting values.

**Note:**

- If response to the speed reference is slow, increase the setting value.
- Decrease the setting value in these conditions:
  - The speed is overshooting.
  - A negative torque reference is output when acceleration ends.

### ■ n5-04: Speed Response Frequency

No. (Hex.)	Name	Description	Default (Range)
n5-04 (05B3) RUN Expert	Speed Response Frequency	<span>V/f</span> <span>CL-V/f</span> <span>OLV</span> <span>CLV</span> <span>AOLV</span> <span>OLV/PM</span> <span>AOLV/PM</span> <span>CLV/PM</span> <span>EZOLV</span> Sets the response frequency for the speed reference. Usually it is not necessary to change this setting.	Determined by A1-02 (0.00 - 500.00 Hz)

If you set *n5-03* [*Feed Forward Control Gain*] too high, the motor speed will momentarily increase to more than the set frequency.

## ◆ n6: Online Tuning

*n6* parameters are used to set the online tuning function for motor line-to-line resistance.

The Online Tuning for motor line-to-line resistance is used to prevent degradation of speed control accuracy due to motor temperature fluctuation and motor stalls due to insufficient torque.

### ■ n6-01: Online Tuning Selection

No. (Hex.)	Name	Description	Default (Range)
n6-01 (0570)	Online Tuning Selection	<div style="display: flex; justify-content: space-between; font-size: small;"> <span>V/f</span> <span>CL-V/f</span> <span style="background-color: #cccccc;">OLV</span> <span>CLV</span> <span>AOLV</span> <span>OLV/PM</span> <span>AOLV/PM</span> <span>CLV/PM</span> <span>EZOLV</span> </div> Sets the type of motor data that Online Tuning uses for OLV control.	0 (0 - 2)

**0 : Disabled**

### 1 : Line-to-Line Resistance Tuning

The drive adjusts the motor line-to-line resistance during run. This procedure is applicable for speed values 6 Hz and less. It also adjusts the motor resistance value to increase the overload capacity in the low speed range.

### 2 : Voltage Correction Tuning

The drive adjusts the output voltage during run to increase overload tolerance and minimize the effects of high temperatures on speed precision.

**Note:**

Setting 2 is enabled only when  $b8-01 = 0$  [Energy Saving Control Selection = Disabled].

### ■ n6-05: Online Tuning Gain

No. (Hex.)	Name	Description	Default (Range)
n6-05 (05C7) Expert	Online Tuning Gain	<div style="display: flex; justify-content: space-between; font-size: small;"> <span>V/f</span> <span>CL-V/f</span> <span style="background-color: #cccccc;">OLV</span> <span>CLV</span> <span>AOLV</span> <span>OLV/PM</span> <span>AOLV/PM</span> <span>CLV/PM</span> <span>EZOLV</span> </div> Sets the compensation gain when $n6-01 = 2$ [Online Tuning Selection = Voltage Correction Tuning]. Usually it is not necessary to change this setting.	1.0 (0.1 - 50.0)

When you use a motor that has a large secondary circuit time constant, decrease the setting value.

If the drive detects  $oL1$  [Motor Overload], increase the setting value in 0.1-unit increments.

### ■ n6-11: Online Resistance Tuning

No. (Hex.)	Name	Description	Default (Range)
n6-11 (1B56) Expert	Online Resistance Tuning	<div style="display: flex; justify-content: space-between; font-size: small;"> <span>V/f</span> <span>CL-V/f</span> <span>OLV</span> <span style="background-color: #cccccc;">CLV</span> <span style="background-color: #cccccc;">AOLV</span> <span>OLV/PM</span> <span>AOLV/PM</span> <span>CLV/PM</span> <span>EZOLV</span> </div> Sets the responsiveness for online resistor tuning. Set this parameter to approximately 1.000 to enable the function. The function is disabled when the value is 0.000.	0.000 (0.000 - 1.000)

### ◆ n7: EZ Drive

The  $n7$  parameters provide special adjustments for EZ Vector Control.

### ■ n7-01: Damping Gain for Low Frequency

No. (Hex.)	Name	Description	Default (Range)
n7-01 (3111) Expert	Damping Gain for Low Frequency	<div style="display: flex; justify-content: space-between; font-size: small;"> <span>V/f</span> <span>CL-V/f</span> <span>OLV</span> <span>CLV</span> <span>AOLV</span> <span>OLV/PM</span> <span>AOLV/PM</span> <span>CLV/PM</span> <span style="background-color: #cccccc;">EZOLV</span> </div> Sets the oscillation suppression gain for the low speed range.	1.0 (0.1 - 10.0)

**Note:**

- If oscillation occurs in the low speed range, increase the acceleration time or increase the setting value in 0.5-unit increments.
- To get starting torque with the setting for  $C4-01$  [Torque Compensation Gain], decrease the setting value in 0.3-unit increments.

### ■ n7-05: Response Gain for Load Changes

No. (Hex.)	Name	Description	Default (Range)
n7-05 (3115) Expert	Response Gain for Load Changes	<div style="display: flex; justify-content: space-between; font-size: small;"> <span>V/f</span> <span>CL-V/f</span> <span>OLV</span> <span>CLV</span> <span>AOLV</span> <span>OLV/PM</span> <span>AOLV/PM</span> <span>CLV/PM</span> <span style="background-color: #cccccc;">EZOLV</span> </div> Sets the response gain related to changes in the load.	100 (10 - 1000)



**Note:**

To make tracking related to load changes better, increase the setting value in 5-unit increments. If oscillation occurs during load changes, decrease the setting value in 5-unit increments.

### ■ n7-07: Speed Calculation Gain1

No. (Hex.)	Name	Description	Default (Range)
n7-07 (3117) Expert	Speed Calculation Gain1	<span>V/f</span> <span>CL-V/f</span> <span>OLV</span> <span>CLV</span> <span>AOLV</span> <span>OLV/PM</span> <span>AOLV/PM</span> <span>CLV/PM</span> <span>EZOLV</span> Sets the speed calculation gain during usual operation.	15.0 Hz (1.0 - 50.0 Hz)

### ■ n7-08: Speed Calculation Gain2

No. (Hex.)	Name	Description	Default (Range)
n7-08 (3118) Expert	Speed Calculation Gain2	<span>V/f</span> <span>CL-V/f</span> <span>OLV</span> <span>CLV</span> <span>AOLV</span> <span>OLV/PM</span> <span>AOLV/PM</span> <span>CLV/PM</span> <span>EZOLV</span> Sets the speed calculation gain during a speed search.	25.0 Hz (1.0 - 50.0 Hz)

**Note:**

When you increase the setting value, you can do a speed search of a motor rotating at a high frequency. If the setting value is too high, the calculated speed will oscillate and a restart will fail. Decrease the setting value in these conditions.

### ■ n7-10: Pull-in Current Switching Speed

No. (Hex.)	Name	Description	Default (Range)
n7-10 (311A) Expert	Pull-in Current Switching Speed	<span>V/f</span> <span>CL-V/f</span> <span>OLV</span> <span>CLV</span> <span>AOLV</span> <span>OLV/PM</span> <span>AOLV/PM</span> <span>CLV/PM</span> <span>EZOLV</span> Sets a speed range proportional to the rated frequency that enables pull-in current commands.	10.0% (0.0 - 100.0%)

**Note:**

- The value set in *n8-51 [Pull-in Current @ Acceleration]* is enabled for speeds that are not higher than the value set in *n7-10*. The value set in *b8-01 [Energy Saving Control Selection]* is enabled for speeds higher than the value set in *n7-10*.
- If there is a large quantity of oscillation when you operate in the low speed range, increase the setting value.
- When it is most important to save energy in the low speed range, decrease the setting value.

### ■ n7-17: Resistance TemperatureCorrection

No. (Hex.)	Name	Description	Default (Range)
n7-17 (3122)	Resistance TemperatureCorrection	<span>V/f</span> <span>CL-V/f</span> <span>OLV</span> <span>CLV</span> <span>AOLV</span> <span>OLV/PM</span> <span>AOLV/PM</span> <span>CLV/PM</span> <span>EZOLV</span> Sets the function to adjust for changes in the motor resistance value caused by changes in the temperature.	1 (0 - 2)

#### 0 : Invalid

#### 1 : Valid (Only 1 time)

#### 2 : Valid (Every time)

**Note:**

- For settings 1 and 2, the adjustment time can cause a delay before startup.
- For settings 1 and 2, the drive can set the line-to-line resistance value of *E9-10 [Motor Line-to-Line Resistance]*.
- When the temperature will change at startup, use setting 2.
- To decrease the startup time, set this parameter to 0, then do line-to-line resistance tuning.
- If you will start from coasting, set this parameter to 0, then do line-to-line resistance tuning.

## ◆ n8: PM Motor Control Tuning

*n8 parameters* are used to make adjustments when controlling PM motors.

### ■ n8-01: Pole Position Detection Current

No. (Hex.)	Name	Description	Default (Range)
n8-01 (0540) Expert	Pole Position Detection Current	<span>V/f</span> <span>CL-V/f</span> <span>OLV</span> <span>CLV</span> <span>AOLV</span> <span>OLV/PM</span> <span>AOLV/PM</span> <span>CLV/PM</span> <span>EZOLV</span> Sets the Initial Rotor Position Estimated Current as a percentage where $E5-03$ [PM Motor Rated Current (FLA)] = 100%. Usually it is not necessary to change this setting.	50% (0 - 100%)

The drive uses the Initial Rotor Position Estimated Current to detect the initial position of rotors.

If the motor nameplate has an “Si” item, use that value.

### ■ n8-02: Pole Alignment Current Level

No. (Hex.)	Name	Description	Default (Range)
n8-02 (0541) Expert	Pole Alignment Current Level	<span>V/f</span> <span>CL-V/f</span> <span>OLV</span> <span>CLV</span> <span>AOLV</span> <span>OLV/PM</span> <span>AOLV/PM</span> <span>CLV/PM</span> <span>EZOLV</span> Sets the current at the time of polar attraction as a percentage where motor rated current = 100%. Usually it is not necessary to change this setting.	80% (0 - 150%)

The drive uses the polar pull-in current to attract the rotor after it detects the initial rotor position. When you increase the value of this parameter, the starting torque also increases.

- If the motor does not track correctly at the time of the polar attraction, increase the value in 10% increments. If you set the value too high, the drive will detect *oL2* [Drive Overloaded].
- If the motor oscillates at the time of the polar attraction, decrease the value in 10% increments.

**Note:**

Set  $A1-02 = 7$  [Control Method Selection = PM Closed Loop Vector] and do Rotational Auto-Tuning or Z Pulse Offset Tuning to use this function.

### ■ n8-03: Pole Position Detection Time

No. (Hex.)	Name	Description	Default (Range)
n8-03 (0542)	Pole Position Detection Time	<span>V/f</span> <span>CL-V/f</span> <span>OLV</span> <span>CLV</span> <span>AOLV</span> <span>OLV/PM</span> <span>AOLV/PM</span> <span>CLV/PM</span> <span>EZOLV</span> Sets the length of the Current Starting Time, which is used for Z Pulse Offset Tuning. Usually it is not necessary to change this parameter.	1.5 s (1.5 - 5.0 s)

Sets the length of time of pull-in current when the drive detects the motor magnetic pole of the rotors.

**Note:**

If the motor oscillates at the time of the polar attraction, increase the value in 0.5 s increments. If the value is too high, the drive can detect *oL2* [Drive Overloaded].

### ■ n8-04: Pole Alignment Time

No. (Hex.)	Name	Description	Default (Range)
n8-04 (0543) Expert	Pole Alignment Time	<span>V/f</span> <span>CL-V/f</span> <span>OLV</span> <span>CLV</span> <span>AOLV</span> <span>OLV/PM</span> <span>AOLV/PM</span> <span>CLV/PM</span> <span>EZOLV</span> Sets the length of the Polar Attraction Time, which is used for Z Pulse Offset Tuning. Usually it is not necessary to change this setting.	1.5 s (1.5 - 5.0 s)

Sets the length of time that the pull-in current flows when the drive detects the motor magnetic pole of the rotors.

**Note:**

If the motor oscillates at the time of the polar attraction, increase the value in 0.5 s increments. If you set the value too high, the drive will detect *oL2* [Drive Overloaded].

### ■ n8-11: Observer Calculation Gain 2

No. (Hex.)	Name	Description	Default (Range)
n8-11 (054A)	Observer Calculation Gain 2	<span>V/f</span> <span>CL-V/f</span> <span>OLV</span> <span>CLV</span> <span>AOLV</span> <span>OLV/PM</span> <span>AOLV/PM</span> <span>CLV/PM</span> <span>EZOLV</span> Sets the gain for speed estimation. Usually it is not necessary to change this setting.	Determined by n8-72 (0.0 - 1000.0)

**Note:**

When  $n8-72 = 0$  [*Speed Estimation Method Select = Method 1*], the default value is 50.0. When  $n8-72 = 1$  [*Method 2*], the default value is 30.0 for drives that have a maximum capacity of 2042 (4023). The default is 50.0 for 2056 (4031) and larger models.

### ■ n8-14: Polarity Compensation Gain 3

No. (Hex.)	Name	Description	Default (Range)
n8-14 (054D) Expert	Polarity Compensation Gain 3	<span>V/f</span> <span>CL-V/f</span> <span>OLV</span> <span>CLV</span> <span>AOLV</span> <span>OLV/PM</span> <span>AOLV/PM</span> <span>CLV/PM</span> <span>EZOLV</span> Sets the gain for speed estimation. Usually it is not necessary to change this setting.	1.000 (0.000 - 10.000)

### ■ n8-15: Polarity Compensation Gain 4

No. (Hex.)	Name	Description	Default (Range)
n8-15 (054E) Expert	Polarity Compensation Gain 4	<span>V/f</span> <span>CL-V/f</span> <span>OLV</span> <span>CLV</span> <span>AOLV</span> <span>OLV/PM</span> <span>AOLV/PM</span> <span>CLV/PM</span> <span>EZOLV</span> Sets the gain for speed estimation. Usually it is not necessary to change this setting.	0.500 (0.000 - 10.000)

### ■ n8-21: Motor Back-EMF (Ke) Gain

No. (Hex.)	Name	Description	Default (Range)
n8-21 (0554) Expert	Motor Back-EMF (Ke) Gain	<span>V/f</span> <span>CL-V/f</span> <span>OLV</span> <span>CLV</span> <span>AOLV</span> <span>OLV/PM</span> <span>AOLV/PM</span> <span>CLV/PM</span> <span>EZOLV</span> Sets the gain for speed estimation. Usually it is not necessary to change this setting.	0.90 (0.80 - 1.00)

### ■ n8-35: Initial Pole Detection Method

No. (Hex.)	Name	Description	Default (Range)
n8-35 (0562)	Initial Pole Detection Method	<span>V/f</span> <span>CL-V/f</span> <span>OLV</span> <span>CLV</span> <span>AOLV</span> <span>OLV/PM</span> <span>AOLV/PM</span> <span>CLV/PM</span> <span>EZOLV</span> Sets how the drive detects the position of the rotor at start.	Determined by A1-02 (0 - 2)

When  $A1-02 = 7$  [*Control Method Selection = PM Closed Loop Vector*], the initial motor magnetic pole detection operates the first time after the drive is energized. After that, the drive uses the encoder signal to calculate the rotor position and the drive saves the value until the drive is de-energized.

#### 0 : Pull-in

Starts the rotor with pull-in current.

#### 1 : High Frequency Injection

Injects high frequency to detect the rotor position. This setting can cause a loud excitation sound when the motor starts.

#### 2 : Pulse Injection

Inputs the pulse signal to the motor to detect the rotor position.

**Note:**

- When you use an SPM motor, set this parameter to 0. Values between 0 to 2 can be selected if using IPM motors.
- If the drive incorrectly detects the polarity direction, the motor can rotate in the opposite direction of the Run command.

### ■ n8-36: HFI Frequency Level for L Tuning

No. (Hex.)	Name	Description	Default (Range)
n8-36 (0563)	HFI Frequency Level for L Tuning	<span>V/f</span> <span>CL-V/f</span> <span>OLV</span> <span>CLV</span> <span>AOLV</span> <span>OLV/PM</span> <span>AOLV/PM</span> <span>CLV/PM</span> <span>EZOLV</span> Sets the injection frequency for high frequency injection.	500 Hz (200 - 5000 Hz)

PM Rotational Auto-Tuning and PM Stationary Auto-Tuning automatically calculate this parameter value.

### ■ n8-37: HFI Voltage Amplitude Level

No. (Hex.)	Name	Description	Default (Range)
n8-37 (0564) Expert	HFI Voltage Amplitude Level	<div style="display: flex; justify-content: space-between; font-size: small;"> <span>V/f</span> <span>CL-V/f</span> <span>OLV</span> <span>CLV</span> <span>AOLV</span> <span>OLV/PM</span> <span>AOLV/PM</span> <span>CLV/PM</span> <span>EZOLV</span> </div> <p>Sets the high frequency injection amplitude as a percentage where 200 V = 100% for 200 V class drives and 400 V = 100% for a 400 V class drives. Usually it is not necessary to change this setting.</p>	20.0% (0.0 - 50.0%)

Set  $n8-57 = 1$  [*HFI Overlap Selection = Enabled*] to enable this parameter. When you do Auto-Tuning or Rotational Auto-Tuning, the drive will automatically set this parameter.

**Note:**

When you change  $C6-02$  [*Carrier Frequency Selection*], the drive automatically initializes this parameter. Set the carrier frequency you will use, then do Auto-Tuning.

### ■ n8-41: HFI P Gain

No. (Hex.)	Name	Description	Default (Range)
n8-41 (0568) Expert	HFI P Gain	<div style="display: flex; justify-content: space-between; font-size: small;"> <span>V/f</span> <span>CL-V/f</span> <span>OLV</span> <span>CLV</span> <span>AOLV</span> <span>OLV/PM</span> <span>AOLV/PM</span> <span>CLV/PM</span> <span>EZOLV</span> </div> <p>Sets the speed estimation response for high frequency injection. Usually it is not necessary to change this setting.</p>	3.0 (1.0 - 100.0)

**Note:**

Set  $n8-57 = 1$  [*HFI Overlap Selection = Enabled*] or  $n8-35 = 1$  [*Initial Pole Detection Method = High Frequency Injection*] to enable this parameter.

### ■ n8-42: HFI I Time

No. (Hex.)	Name	Description	Default (Range)
n8-42 (0569) Expert	HFI I Time	<div style="display: flex; justify-content: space-between; font-size: small;"> <span>V/f</span> <span>CL-V/f</span> <span>OLV</span> <span>CLV</span> <span>AOLV</span> <span>OLV/PM</span> <span>AOLV/PM</span> <span>CLV/PM</span> <span>EZOLV</span> </div> <p>Sets the oscillation suppression gain of the speed estimation for high frequency injection. Usually it is not necessary to change this setting.</p>	1.0 (0.1 - 5.0)

**Note:**

Set  $n8-57 = 1$  [*HFI Overlap Selection = Enabled*] or  $n8-35 = 1$  [*Initial Pole Detection Method = High Frequency Injection*] to enable this parameter.

### ■ n8-45: Speed Feedback Detection Gain

No. (Hex.)	Name	Description	Default (Range)
n8-45 (0538)	Speed Feedback Detection Gain	<div style="display: flex; justify-content: space-between; font-size: small;"> <span>V/f</span> <span>CL-V/f</span> <span>OLV</span> <span>CLV</span> <span>AOLV</span> <span>OLV/PM</span> <span>AOLV/PM</span> <span>CLV/PM</span> <span>EZOLV</span> </div> <p>Sets the internal speed feedback detection reduction unit gain as a magnification value. Usually it is not necessary to change this parameter.</p>	0.80 (0.00 - 10.00)

Adjust this parameter in these conditions:

- If vibration or hunting occur, increase the setting value in 0.05 unit increments.
- If the responsiveness of torque and speed is unsatisfactory, decrease the setting value 0.05 unit increments and examine the response.

### ■ n8-47: Pull-in Current Comp Filter Time

No. (Hex.)	Name	Description	Default (Range)
n8-47 (053A)	Pull-in Current Comp Filter Time	<div style="display: flex; justify-content: space-between; font-size: small;"> <span>V/f</span> <span>CL-V/f</span> <span>OLV</span> <span>CLV</span> <span>AOLV</span> <span>OLV/PM</span> <span>AOLV/PM</span> <span>CLV/PM</span> <span>EZOLV</span> </div> <p>Sets the time constant the drive uses to align the pull-in current reference value with the actual current value. Usually it is not necessary to change this parameter.</p>	5.0 s (0.0 - 100.0 s)

Adjust this parameter in these conditions:

- If the time for the reference value of the pull-in current to align with the target value is too long, increase the setting value.

- If vibration or hunting occur, decrease the setting value in 0.2 unit increments.
- If the motor stalls during run at constant speed, decrease the setting value in 0.2 unit increments.

### ■ n8-48: Pull-in/Light Load Id Current

No. (Hex.)	Name	Description	Default (Range)
n8-48 (053B)	Pull-in/Light Load Id Current	<div style="display: flex; justify-content: space-between; font-size: small;"> <span>V/f</span> <span>CL-V/f</span> <span>OLV</span> <span>CLV</span> <span>AOLV</span> <span style="background-color: #cccccc;">OLV/PM</span> <span>AOLV/PM</span> <span>CLV/PM</span> <span>EZOLV</span> </div> <p>Sets the d-axis current that flows to the motor during run at constant speed as a percentage where <math>E5-03</math> [PM Motor Rated Current (FLA)] = 100%.</p>	30% (20 - 200%)

Adjust in the following situations.

- Slightly reduce this value if there is too much current when driving a light load at a constant speed.
- Increase the setting value in steps of 5% when hunting or vibration occurs during run at constant speed.
- Increase the setting value in steps of 5% if the motor stalls during run at constant speed.

### ■ n8-49: Heavy Load Id Current

No. (Hex.)	Name	Description	Default (Range)
n8-49 (053C) Expert	Heavy Load Id Current	<div style="display: flex; justify-content: space-between; font-size: small;"> <span>V/f</span> <span>CL-V/f</span> <span>OLV</span> <span>CLV</span> <span>AOLV</span> <span style="background-color: #cccccc;">OLV/PM</span> <span>AOLV/PM</span> <span>CLV/PM</span> <span>EZOLV</span> </div> <p>Sets the d-axis current to that the drive will supply to the motor to run it at a constant speed with a heavy load. This parameter is a percentage where <math>E5-03</math> [PM Motor Rated Current (FLA)] = 100%. Usually it is not necessary to change this setting.</p>	Determined by E5-01 (-200.0 - 0.0%)

When you use an IPM motor, you can use the reluctance torque of the motor to make the motor more efficient and help conserve energy.

When you operate an SPN motor, set this parameter to 0.

Adjust this parameter in these conditions:

- If the load is large and motor rotation is not stable, decrease the setting value.
- If you change the *E5 parameters* [PM Motor Settings], set  $n8-49 = 0$ , then adjust this parameter.

### ■ n8-51: Pull-in Current @ Acceleration

No. (Hex.)	Name	Description	Default (Range)
n8-51 (053E)	Pull-in Current @ Acceleration	<div style="display: flex; justify-content: space-between; font-size: small;"> <span>V/f</span> <span>CL-V/f</span> <span>OLV</span> <span>CLV</span> <span>AOLV</span> <span style="background-color: #cccccc;">OLV/PM</span> <span>AOLV/PM</span> <span>CLV/PM</span> <span style="background-color: #cccccc;">EZOLV</span> </div> <p>Sets the pull-in current that can flow during acceleration/deceleration as a percentage where <math>E5-03</math> [PM Motor Rated Current (FLA)] = 100%.</p>	Determined by A1-02 (0 - 200%)

Adjust this parameter in these conditions:

- When the motor does not smoothly because of large loads, increase the setting value in 5% increments.
- If too much current flows during acceleration, decrease the setting value.

**Note:**

When  $A1-02 = 8$  [Control Method Selection = EZ Vector Control], this parameter will always be in effect for speed ranges less than  $n7-10$  [Pull-in Current Switching Speed].

### ■ n8-54: Voltage Error Compensation Time

No. (Hex.)	Name	Description	Default (Range)
n8-54 (056D) Expert	Voltage Error Compensation Time	<div style="display: flex; justify-content: space-between; font-size: small;"> <span>V/f</span> <span>CL-V/f</span> <span>OLV</span> <span>CLV</span> <span>AOLV</span> <span style="background-color: #cccccc;">OLV/PM</span> <span>AOLV/PM</span> <span>CLV/PM</span> <span>EZOLV</span> </div> <p>Sets the time constant that the drive uses when adjusting for voltage errors.</p>	1.00 s (0.00 - 10.00 s)

Adjust this parameter in these conditions:

- If oscillation occurs at the time of start up, increase the setting value.
- If hunting occurs when operating at low speed, increase the setting value.

- If fast changes in the load cause hunting, increase the setting value in 0.1-unit increments. If you cannot stop hunting, set *n8-51 [Pull-in Current @ Acceleration]* to 0% and set *n8-54* to 0.00 s, and disable compensation for voltage errors.

■ **n8-55: Motor to Load Inertia Ratio**

No. (Hex.)	Name	Description	Default (Range)
n8-55 (056E)	Motor to Load Inertia Ratio	<div style="display: flex; justify-content: space-between; font-size: 0.8em; margin-bottom: 5px;"> <span>V/f</span> <span>CL-V/f</span> <span>OLV</span> <span>CLV</span> <span>AOLV</span> <span style="background-color: #cccccc;">OLV/IPM</span> <span>AOLV/IPM</span> <span>CLV/IPM</span> <span>EZOLV</span> </div> Sets the ratio between motor inertia and machine inertia.	0 (0 - 3)

Adjust this parameter in the these conditions:

- If torque and speed response is unsatisfactory, gradually increase the setting.
- If motors do not start smoothly, gradually increase the setting.
- If the motor stalls during run at constant speed, gradually increase the setting.
- If there is vibration or hunting, decrease the setting.

**Note:**

- If the value too low, the drive will detect *STPo [Motor Step-Out Detected]*.
- If you use one motor or more than motor at low inertia and the value is too high, there can be vibration in the motor.

**0 : Below 1:10**

Use this setting in these conditions:

- The ratio between the motor inertia and machine inertia is less than 1:10
- There are large current ripples

**1 : Between 1:10 and 1:30**

Use this setting in these conditions:

- The ratio between the motor inertia and machine inertia is approximately 1:10 to 1:30
- Parameter *n8-55 = 0* and the drive detects *STPo* because of an impact load or sudden acceleration/deceleration.

**2 : Between 1:30 and 1:50**

Use this setting in these conditions:

- The ratio between the motor inertia and machine inertia is approximately 1:30 to 1:50
- Parameter *n8-55 = 1* and the drive detects *STPo* because of an impact load or sudden acceleration/deceleration.

**3 : Beyond 1:50**

Use this setting in these conditions:

- The ratio between the motor inertia and machine inertia is more than 1:50
- Parameter *n8-55 = 2* and the drive detects *STPo* because of an impact load or sudden acceleration/deceleration.

■ **n8-57: HFI Overlap Selection**

No. (Hex.)	Name	Description	Default (Range)
n8-57 (0574)	HFI Overlap Selection	<div style="display: flex; justify-content: space-between; font-size: 0.8em; margin-bottom: 5px;"> <span>V/f</span> <span>CL-V/f</span> <span>OLV</span> <span>CLV</span> <span>AOLV</span> <span>OLV/IPM</span> <span style="background-color: #cccccc;">AOLV/IPM</span> <span>CLV/IPM</span> <span>EZOLV</span> </div> Sets the function that detects motor speed with high frequency injection.	0 (0, 1)

**Note:**

- When there is high frequency injection, the motor will make an excitation sound.
- When you use Zero Speed Control, set *E1-09 [Minimum Output Frequency] = 0.0*.

**0 : Disabled**

Use this setting with SPM motors. The speed control range is approximately 1:20.

When *n8-57 = 0*, you cannot set *E1-09 [Minimum Output Frequency] ≤ 1/20* of the value of *E1-06 [Base Frequency]*.

**1 : Enabled**

Use this setting with IPM motors. The speed control range changes to 1:100 for very accurate speed detection.

### ■ n8-62: Output Voltage Limit Level

No. (Hex.)	Name	Description	Default (Range)
n8-62 (057D) Expert	Output Voltage Limit Level	V/f CL-V/f OLV CLV AOLV <b>OLV/PM</b> AOLV/PM CLV/PM EZOLV Sets the output voltage limit to prevent saturation of the output voltage. Usually it is not necessary to change this setting.	200 V Class: 200.0 V, 400 V Class: 400.0 V (200 V Class: 0.0 - 230.0 V, 400 V Class: 0.0 - 460.0 V)

Set this parameter lower than the input power supply voltage.

### ■ n8-65: Speed Fdbk Gain @ oV Suppression

No. (Hex.)	Name	Description	Default (Range)
n8-65 (065C) Expert	Speed Fdbk Gain @ oV Suppression	V/f CL-V/f OLV CLV AOLV <b>OLV/PM</b> AOLV/PM CLV/PM EZOLV Sets the gain of internal speed feedback detection suppression while the overvoltage suppression function is operating as a magnification value. Usually it is not necessary to change this parameter.	1.50 (0.00 - 10.00)

Adjust this parameter in these conditions:

- If there is resonance or hunting when you use the overvoltage suppression function, increase the setting value.
- If motor response is low when you use the overvoltage suppression function, decrease the setting value in 0.05-unit increments.

### ■ n8-69: Speed Observer Control P Gain

No. (Hex.)	Name	Description	Default (Range)
n8-69 (065D) Expert	Speed Observer Control P Gain	V/f CL-V/f OLV CLV AOLV <b>OLV/PM</b> AOLV/PM CLV/PM EZOLV Sets the gain that the drive uses for speed estimation. Usually it is not necessary to change this setting.	1.00 (0.00 - 20.00)

### ■ n8-72: Speed Estimation Method Select

No. (Hex.)	Name	Description	Default (Range)
n8-72 (0655) Expert	Speed Estimation Method Select	V/f CL-V/f OLV CLV AOLV <b>OLV/PM</b> AOLV/PM CLV/PM EZOLV Selects the speed estimation method. Usually it is not necessary to change this setting.	1 (0, 1)

0 : Method 1

1 : Method 2

### ■ n8-74: Light Load Iq Level

No. (Hex.)	Name	Description	Default (Range)
n8-74 (05C3) Expert	Light Load Iq Level	V/f CL-V/f OLV CLV AOLV <b>OLV/PM</b> AOLV/PM CLV/PM EZOLV Set n8-48 [Pull-in/Light Load Id Current] to the level of the load current (q-axis current) to be applied.	30% (0 - 255%)

**Note:**

- If n8-74 > n8-75 [Medium Load Iq Level (low)], the drive will detect oPE08 [Parameter Selection Error].
- The change is linear between n8-74 and n8-75 and the level of the pull-in current from n8-48 to n8-78 [Medium Load Id Current].

### ■ n8-75: Medium Load Iq Level (low)

No. (Hex.)	Name	Description	Default (Range)
n8-75 (05C4) Expert	Medium Load Iq Level (low)	<div style="display: flex; justify-content: space-between; font-size: 0.8em; margin-bottom: 5px;"> <span>V/f</span> <span>CL-V/f</span> <span>OLV</span> <span>CLV</span> <span>AOLV</span> <span style="background-color: #cccccc;">OLV/PM</span> <span>AOLV/PM</span> <span>CLV/PM</span> <span>EZOLV</span> </div> Set n8-78 [Medium Load Id Current] to the level of the load current (q-axis current) to be applied.	50% (0 - 255%)

**Note:**

- If n8-74 [Light Load Iq Level] > n8-75, the drive will detect oPE08 [Parameter Selection Error].
- The change is linear between n8-74 and n8-75 and the level of the pull-in current from n8-48 to n8-78 [Medium Load Id Current].

### ■ n8-77: Heavy Load Iq Level

No. (Hex.)	Name	Description	Default (Range)
n8-77 (05CE) Expert	Heavy Load Iq Level	<div style="display: flex; justify-content: space-between; font-size: 0.8em; margin-bottom: 5px;"> <span>V/f</span> <span>CL-V/f</span> <span>OLV</span> <span>CLV</span> <span>AOLV</span> <span style="background-color: #cccccc;">OLV/PM</span> <span>AOLV/PM</span> <span>CLV/PM</span> <span>EZOLV</span> </div> Set n8-49 [Heavy Load Id Current] to the level of the load current (q-axis current) to be applied.	90% (0 - 255%)

**Note:**

The change is linear between n8-75 [Medium Load Iq Level (low)] and n8-77 and the level of the pull-in current from n8-78 [Medium Load Id Current] to n8-49 [Heavy Load Id Current].

### ■ n8-78: Medium Load Id Current

No. (Hex.)	Name	Description	Default (Range)
n8-78 (05F4) Expert	Medium Load Id Current	<div style="display: flex; justify-content: space-between; font-size: 0.8em; margin-bottom: 5px;"> <span>V/f</span> <span>CL-V/f</span> <span>OLV</span> <span>CLV</span> <span>AOLV</span> <span style="background-color: #cccccc;">OLV/PM</span> <span>AOLV/PM</span> <span>CLV/PM</span> <span>EZOLV</span> </div> Sets the level of the pull-in current for mid-range loads.	0% (0 - 255%)

### ■ n8-79: Pull-in Current @ Deceleration

No. (Hex.)	Name	Description	Default (Range)
n8-79 (05FE)	Pull-in Current @ Deceleration	<div style="display: flex; justify-content: space-between; font-size: 0.8em; margin-bottom: 5px;"> <span>V/f</span> <span>CL-V/f</span> <span>OLV</span> <span>CLV</span> <span>AOLV</span> <span style="background-color: #cccccc;">OLV/PM</span> <span>AOLV/PM</span> <span>CLV/PM</span> <span>EZOLV</span> </div> Sets, the pull-in current allowed to flow during deceleration as a percentage of the motor rated current.	0% (0 - 200%)

If overcurrent occurs during deceleration, slowly decrease the setting in 5% increments.

**Note:**

When n8-79 = 0, the drive will use the value set in n8-51 [Pull-in Current @ Acceleration]

### ■ n8-84: Polarity Detection Current

No. (Hex.)	Name	Description	Default (Range)
n8-84 (02D3) Expert	Polarity Detection Current	<div style="display: flex; justify-content: space-between; font-size: 0.8em; margin-bottom: 5px;"> <span>V/f</span> <span>CL-V/f</span> <span>OLV</span> <span>CLV</span> <span>AOLV</span> <span style="background-color: #cccccc;">OLV/PM</span> <span>AOLV/PM</span> <span>CLV/PM</span> <span>EZOLV</span> </div> Sets the current that the drive uses to estimate the initial motor magnetic pole as a percentage where E5-03 [PM Motor Rated Current (FLA)] = 100%.	100% (0 - 150%)

If you use a Yaskawa motor, and the motor nameplate has an “Si” item, set this parameter to a value equivalent to  $S_i \times 2$ .

#### Find the Polarity of Magnetic Poles

When you start operation (only the first time when A1-02 = 7 [Control Method Selection = PM Closed Loop Vector]), the drive estimates the magnetic poles and finds the polarity of the magnetic poles.

Check monitor U6-57 [PolePolarityDeterVal] to make sure that the drive correctly estimated the polarity of the magnetic poles.

When you do Stationary Auto-Tuning or Rotational Auto-Tuning, the drive automatically sets this parameter.



**WARNING!** Sudden Movement Hazard. Make sure that the polarity is correct before you send a Run command. If the drive incorrectly detects the polarity, the drive can rotate in the direction opposite of the Run command. Failure to obey can cause death or serious injury.

### ■ n8-94: Flux Position Estimation Method

No. (Hex.)	Name	Description	Default (Range)
n8-94 (012D) Expert	Flux Position Estimation Method	<div style="display: flex; justify-content: space-between; font-size: 0.8em; margin-bottom: 5px;"> <span>V/f</span> <span>CL-V/f</span> <span>OLV</span> <span>CLV</span> <span>AOLV</span> <span>OLV/PM</span> <span style="background-color: #cccccc;">AOLV/PM</span> <span>CLV/PM</span> <span>EZOLV</span> </div> Sets the criteria that the drive uses to find changes in speed or load. Usually it is not necessary to change this setting.	Determined by d5-01 (0, 1)

#### 0 : Softstarter

#### 1 : Speed Feedback

Set  $n8-57 = 1$  [*HFI Overlap Selection = Enabled*] to enable this parameter. Increases the stability when the speed or load suddenly change, for example with rapid acceleration/deceleration or impact loads.

### ■ n8-95: Flux Position Est Filter Time

No. (Hex.)	Name	Description	Default (Range)
n8-95 (012E) Expert	Flux Position Est Filter Time	<div style="display: flex; justify-content: space-between; font-size: 0.8em; margin-bottom: 5px;"> <span>V/f</span> <span>CL-V/f</span> <span>OLV</span> <span>CLV</span> <span>AOLV</span> <span>OLV/PM</span> <span style="background-color: #cccccc;">AOLV/PM</span> <span>CLV/PM</span> <span>EZOLV</span> </div> Sets the time constant of the filter used for the recognition criteria value for speed and load changes. Usually it is not necessary to change this setting.	30 ms (0 - 100 ms)

**Note:**

Enabled when  $n8-94 = 1$  [*Flux Position Estimation Method = Speed Feedback*].

# 11.11 o: Keypad-Related Settings

*o* parameters set keypad functions.

**Note:**

You cannot set the parameters in [Table 11.76](#) with the optional LED keypad.

**Table 11.76 Parameters that You Cannot Set with the LED Keypad**

No.	Name	No.	Name
o1-05	LCD Contrast Adjustment	o3-04	Select Backup/Restore Location
o1-24 to o1-35	Custom Monitor 1 to 12	o3-05	Select Items to Backup/Restore
o1-36	LCD Backlight Brightness	o3-06	Auto Parameter Backup Selection
o1-37	LCD Backlight ON/OFF Selection	o3-07	Auto Parameter Backup Interval
o1-38	LCD Backlight Off-Delay	o4-22	Time Format
o1-39	Show Initial Setup Screen	o4-23	Date Format
o1-40	Home Screen Display Selection	o5-01	Log Start/Stop Selection
o1-41 to o1-46	1st to 3rd Monitor Area Selections/Settings	o5-02	Log Sampling Interval
o1-47 to o1-51	Trend Plot 1 or 2 Scale Settings	o5-03 to o5-12	Log Monitor Data 1 to 10
o1-55 to o1-56	Analog Gauge Area Selection/Setting		

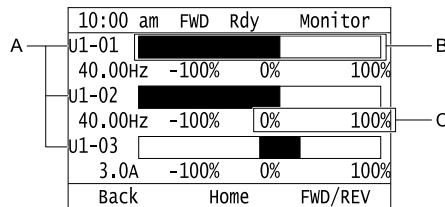
## ◆ o1: Keypad Display Selection

*o1* parameters select the parameters shown on the initial keypad screen and to configure the parameter setting units and display units. These parameters also adjust the backlight and contrast of the LCD display.

### ■ Home Screen Display Format

*o1-40* [Home Screen Display Selection] changes the display of the monitor shown on the Home screen. You can show numerical values or one of these three displays on the Home screen monitor:

#### Bar Graph Display

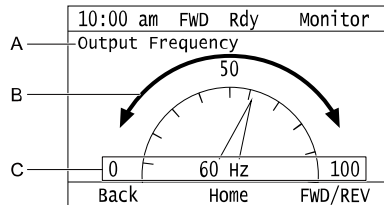


**A - Select *Ux-xx* [Monitors] with *o1-24*, *o1-25*, and *o1-26*.**

**C - Select display ranges with *o1-42*, *o1-44*, and *o1-46*.**

**B - Configure display regions with *o1-41*, *o1-43*, and *o1-45*.**

#### Analog Gauge Display

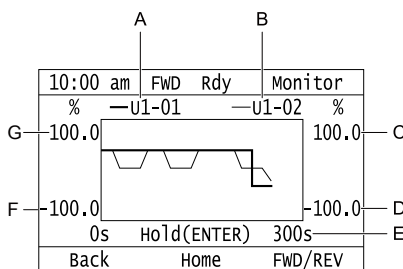


**A - Select *Ux-xx* [Monitors] with *o1-24*.**

**C - Select display ranges with *o1-55*.**

**B - Configure display regions with *o1-56*.**

Trend Plot Display



- A - Select *Ux-xx* [Monitors] (Monitor 1) with *o1-24*.
- B - Select *Ux-xx* [Monitors] (Monitor 2) with *o1-25*.
- C - Set the maximum value of Monitor 2 with *o1-50*
- D - Set the minimum value of Monitor 2 with *o1-49*
- E - Set the time scale with *o1-51*
- F - Set the minimum value of Monitor 1 with *o1-47*
- G - Set the maximum value of Monitor 1 with *o1-48*

■ o1-01: User Monitor Selection

No. (Hex.)	Name	Description	Default (Range)
o1-01 (0500) RUN	User Monitor Selection	<b>V/f</b> <b>CL-V/f</b> <b>OLV</b> <b>CLV</b> <b>AOLV</b> <b>OLV/PM</b> <b>AOLV/PM</b> <b>CLV/PM</b> <b>EZOLV</b> Set the <i>U</i> monitor for the Drive Mode. This parameter is only available when you use an LED keypad.	106 (104 - 855)

When the drive is in Drive Mode, push on the keypad to cycle through the data in this sequence: frequency reference → rotational direction → output frequency → output current → *o1-01* selection.

Set the *x-xx* part of *Ux-xx* that is shown in the fifth position in Drive Mode. For example, to show *U1-05* [Motor Speed], set *o1-01* = 105.

Note:

- You cannot select *U2* monitor [Fault Trace] or *U3* Monitor [Fault History].
- The monitors that you can select are different for different control methods.

■ o1-02: Monitor Selection at Power-up

No. (Hex.)	Name	Description	Default (Range)
o1-02 (0501) RUN	Monitor Selection at Power-up	<b>V/f</b> <b>CL-V/f</b> <b>OLV</b> <b>CLV</b> <b>AOLV</b> <b>OLV/PM</b> <b>AOLV/PM</b> <b>CLV/PM</b> <b>EZOLV</b> Sets the monitor item that the keypad screen shows after energizing the drive. Refer to “U: Monitors” for information about the monitor items that the keypad screen can show. This parameter is only available when using an LED keypad.	1 (1 - 5)

1 : Frequency Reference (U1-01)

2 : Direction

3 : Output Frequency (U1-02)

4 : Output Current (U1-03)

5 : User Monitor (o1-01)

Shows the monitor item selected in *o1-01* [User Monitor Selection].

■ o1-03: Frequency Display Unit Selection

No. (Hex.)	Name	Description	Default (Range)
o1-03 (0502)	Frequency Display Unit Selection	<b>V/f</b> <b>CL-V/f</b> <b>OLV</b> <b>CLV</b> <b>AOLV</b> <b>OLV/PM</b> <b>AOLV/PM</b> <b>CLV/PM</b> <b>EZOLV</b> Sets the display units for the frequency reference and output frequency.	Determined by A1-02 (0 - 3)

Parameter Details

## 11.11 o: Keypad-Related Settings

### Note:

When you change this parameter, these monitor and parameter units also change:

- U1-01 [Freq Reference]
- U1-02 [Output Frequency]
- U1-05 [Motor Speed]
- U1-16 [SFS Output Frequency]
- d1-01 to d1-17 [Reference 1 to 17]

### 0 : 0.01 Hz

### 1 : 0.01% (100% = E1-04)

The maximum output frequency is 100%.

### 2 : Revolutions Per Minute (RPM)

The drive uses the maximum output frequency and number of motor poles calculate this value automatically.

### Note:

When you use this setting, make sure that you set the number of motor poles in these parameters:

- E2-04 [Motor Pole Count]
- E4-04 [Motor 2 Motor Poles]
- E5-04 [PM Motor Pole Count]
- E9-08 [Number of Poles]

### 3 : User Units (o1-10 & o1-11)

Uses o1-10 and o1-11 to set the unit of measure. The value of parameter o1-10 is the value when you remove the decimal point from the maximum output frequency. Parameter o1-11 is to the number of digits after the decimal point in the maximum output frequency.

To show a maximum output frequency of 100.00, set the parameters to these values:

- o1-10 = 10000
- o1-11 = 2 [User Units Decimal Position = 2 Dec (XXX.XX)]

### ■ o1-04: V/f Pattern Display Unit

No. (Hex.)	Name	Description	Default (Range)
o1-04 (0503)	V/f Pattern Display Unit	<div style="display: flex; gap: 5px;"> <span>V/f</span> <span>CL-V/f</span> <span>OLV</span> <span>CLV</span> <span>AOLV</span> <span>OLV/PM</span> <span>AOLV/PM</span> <span>CLV/PM</span> <span>EZOLV</span> </div> Sets the setting unit for parameters that set the V/f pattern frequency.	Determined by A1-02 (0, 1)

### Note:

• Select the setting unit of these parameters for motor 1:

- E1-04 [Maximum Output Frequency]
- E1-06 [Base Frequency]
- E1-07 [Mid Point A Frequency]
- E1-09 [Minimum Output Frequency]
- E1-11 [Mid Point B Frequency]
- E9-02 [Motor Max Revolutions]
- E9-04 [Motor Rated Frequency]

• Select the setting unit of these parameters for motor 2:

- E3-04 [Motor 2 Maximum Output Frequency]
- E3-06 [Motor 2 Base Frequency]
- E3-07 [Motor 2 Mid Point A Frequency]
- E3-09 [Motor 2 Minimum Output Frequency]
- E3-11 [Motor 2 Mid Point B Frequency]

### 0 : Hz

### 1 : Revolutions Per Minute (RPM)

Set the number of motor poles in these parameters:

- E2-04 [Motor Pole Count]
- E4-04 [Motor 2 Motor Poles]
- E5-04 [PM Motor Pole Count]
- E9-08 [Motor Pole Count]

### ■ o1-05: LCD Contrast Adjustment

No. (Hex.)	Name	Description	Default (Range)
o1-05 (0504) RUN	LCD Contrast Adjustment	<b>V/f</b> <b>CL-V/f</b> <b>OLV</b> <b>CLV</b> <b>AOLV</b> <b>OLV/PM</b> <b>AOLV/PM</b> <b>CLV/PM</b> <b>EZOLV</b> Sets the contrast of the LCD display on the keypad.	5 (0 - 10)

When you decrease the setting value, the contrast of the LCD display decreases. When you increase the setting value, the contrast increases.

### ■ o1-10: User Units Maximum Value

No. (Hex.)	Name	Description	Default (Range)
o1-10 (0520)	User Units Maximum Value	<b>V/f</b> <b>CL-V/f</b> <b>OLV</b> <b>CLV</b> <b>AOLV</b> <b>OLV/PM</b> <b>AOLV/PM</b> <b>CLV/PM</b> <b>EZOLV</b> Sets the value that the drive shows as the maximum output frequency.	Determined by o1-03 (1 - 60000)

To display a maximum output frequency of 100.00, set parameters to these values:

- o1-10 = 10000
- o1-11 = 2 [User Units Decimal Position = 2 Dec (XXX.XX)]

Note:

Set o1-03 = 3 [Keypad Display Selection = User-selected units] before you set o1-10 and o1-11.

### ■ o1-11: User Units Decimal Position

No. (Hex.)	Name	Description	Default (Range)
o1-11 (0521)	User Units Decimal Position	<b>V/f</b> <b>CL-V/f</b> <b>OLV</b> <b>CLV</b> <b>AOLV</b> <b>OLV/PM</b> <b>AOLV/PM</b> <b>CLV/PM</b> <b>EZOLV</b> Sets the number of decimal places for frequency reference and monitor values.	Determined by o1-03 (0 - 3)

**0 : No Decimal Places (XXXXX)**

**1 : One Decimal Places (XXXX.X)**

**2 : Two Decimal Places (XXX.XX)**

**3 : Three Decimal Places (XX.XXX)**

Note:

Set o1-03 = 3 [Keypad Display Selection = User-selected units] before you set o1-10 [User-Set Display Units Max Value] and o1-11.

### ■ o1-24 to o1-35: Custom Monitor 1 to 12

No. (Hex.)	Name	Description	Default (Range)
o1-24 to o1-35 (11AD - 11B8) RUN	Custom Monitor 1 to 12	<b>V/f</b> <b>CL-V/f</b> <b>OLV</b> <b>CLV</b> <b>AOLV</b> <b>OLV/PM</b> <b>AOLV/PM</b> <b>CLV/PM</b> <b>EZOLV</b> Sets a maximum of 12 monitors as user monitors. This parameter is only available with an LED keypad.	o1-24: 101 o1-25: 102 o1-26: 103 o1-27 to o1-35: 0 (0, 101 - 999)

These parameters save the monitor items selected by the LCD keypad [Custom Monitor].

**Note:**

- You can show a maximum of three selected monitors on one LCD keypad screen.
  - When you select only one monitor, the text size of this monitor increases. For example, when  $o1-25$  to  $o1-35 = 0$ , the text size of the monitor saved in  $o1-24$  increases.
  - When you select two monitors, the text size of these monitors increase.
  - When you select four or more monitors, the fourth monitor and all additional monitors are shown on the next screens.
- You can show the monitors that you select with  $o1-24$  to  $o1-26$  as a bar graph, analog gauge, or trend plot.
  - Bar graph display: 3 monitors maximum  
Select with  $o1-24$ ,  $o1-25$ , and  $o1-26$ .
  - Analog gauge display: 1 monitor  
Select with  $o1-24$ .
  - Trend plot display: 2 monitors  
Select with  $o1-24$  and  $o1-25$ .
- You can only set parameters  $o1-24$  to  $o1-26$  with analog output monitors.
- You can set parameters  $o1-27$  to  $o1-35$  with all monitors.

■ **o1-36: LCD Backlight Brightness**

No. (Hex.)	Name	Description	Default (Range)
o1-36 (11B9) RUN	LCD Backlight Brightness	<b>V/f</b> <b>CL-V/f</b> <b>OLV</b> <b>CLV</b> <b>AOLV</b> <b>OLV/PM</b> <b>AOLV/PM</b> <b>CLV/PM</b> <b>EZOLV</b> Sets the intensity of the LCD keypad backlight.	3 (1 - 5)

When you decrease the setting value, the intensity of the backlight decreases. When you increase the setting value, the intensity of the backlight increases.

■ **o1-37: LCD Backlight ON/OFF Selection**

No. (Hex.)	Name	Description	Default (Range)
o1-37 (11BA) RUN	LCD Backlight ON/OFF Selection	<b>V/f</b> <b>CL-V/f</b> <b>OLV</b> <b>CLV</b> <b>AOLV</b> <b>OLV/PM</b> <b>AOLV/PM</b> <b>CLV/PM</b> <b>EZOLV</b> Sets the automatic shut off function for the LCD backlight.	1 (0, 1)

**Note:**

Use  $o1-36$  [LCD backlight adjustment] to adjust the intensity of the LCD backlight.

**0 : OFF**

**1 : ON**

Enables the automatic shut off function. The time at which the LCD backlight automatically turns off is configured with  $o1-38$  [Time to turn off LCD backlight].

■ **o1-38: LCD Backlight Off-Delay**

No. (Hex.)	Name	Description	Default (Range)
o1-38 (11BB) RUN	LCD Backlight Off-Delay	<b>V/f</b> <b>CL-V/f</b> <b>OLV</b> <b>CLV</b> <b>AOLV</b> <b>OLV/PM</b> <b>AOLV/PM</b> <b>CLV/PM</b> <b>EZOLV</b> Sets the time until the LCD backlight automatically turns off.	60 s (10 - 300 s)

When  $o1-37 = 1$  [LCD backlight ON/OFF Selection = ON], the backlight will automatically turn off after the time set in  $o1-38$  is expired.

When the backlight is off, push a key on the keypad to temporarily turn the backlight on. After the backlight turns on, it will turn off automatically after the time set in  $o1-38$  is expired.

■ **o1-39: Show Initial Setup Screen**

No. (Hex.)	Name	Description	Default (Range)
o1-39 (11BC) RUN	Show Initial Setup Screen	<b>V/f</b> <b>CL-V/f</b> <b>OLV</b> <b>CLV</b> <b>AOLV</b> <b>OLV/PM</b> <b>AOLV/PM</b> <b>CLV/PM</b> <b>EZOLV</b> Sets the function to show the LCD keypad initial setup screen each time the drive is energized. This parameter is only available when using an LCD keypad.	1 (0, 1)

The initial setup screen shows a menu where you can select the display language, set the date, time, and other basic settings. When you set this parameter to 0, the drive will not show this screen each time you energize the drive.

### 0 : No

The drive will not show the initial setup display screen each time you energize the drive. The drive will show the Home screen.

### 1 : Yes

When you input the Run command before you energize the drive or when you turn on the Run command while the drive shows the initial setup screen, the drive will replace the initial setup screen with the Home screen.

## ■ o1-40: Home Screen Display Selection

No. (Hex.)	Name	Description	Default (Range)
o1-40 (11BD) RUN	Home Screen Display Selection	<b>V/f</b> <b>CL-V/f</b> <b>OLV</b> <b>CLV</b> <b>AOLV</b> <b>OLV/PM</b> <b>AOLV/PM</b> <b>CLV/PM</b> <b>EZOLV</b> Sets the monitor display mode for the Home screen. This parameter is only available when using an LCD keypad.	0 (0 - 3)

### 0 : Custom Monitor

### 1 : Bar Graph

### 2 : Analog Gauge

### 3 : Trend Plot

## ■ o1-41: 1st Monitor Area Selection

No. (Hex.)	Name	Description	Default (Range)
o1-41 (11C1) RUN	1st Monitor Area Selection	<b>V/f</b> <b>CL-V/f</b> <b>OLV</b> <b>CLV</b> <b>AOLV</b> <b>OLV/PM</b> <b>AOLV/PM</b> <b>CLV/PM</b> <b>EZOLV</b> Sets the horizontal axis used to show the monitor that was set in o1-24 [ <i>Custom Monitor 1</i> ] as a bar graph. This parameter is only available with an LCD keypad.	0 (0 - 2)

### 0 : +/- Area ( - o1-42 ~ o1-42 )

### 1 : + Area ( 0 ~ o1-42 )

### 2 : - Area ( - o1-42 ~ 0 )

## ■ o1-42: 1st Monitor Area Setting

No. (Hex.)	Name	Description	Default (Range)
o1-42 (11C2) RUN	1st Monitor Area Setting	<b>V/f</b> <b>CL-V/f</b> <b>OLV</b> <b>CLV</b> <b>AOLV</b> <b>OLV/PM</b> <b>AOLV/PM</b> <b>CLV/PM</b> <b>EZOLV</b> Sets the horizontal axis value used to display the monitor that was set in o1-24 [ <i>Custom Monitor 1</i> ] as a bar graph. This parameter is only available with an LCD keypad.	100.0% (0.0 - 100.0%)

## ■ o1-43: 2nd Monitor Area Selection

No. (Hex.)	Name	Description	Default (Range)
o1-43 (11C3) RUN	2nd Monitor Area Selection	<b>V/f</b> <b>CL-V/f</b> <b>OLV</b> <b>CLV</b> <b>AOLV</b> <b>OLV/PM</b> <b>AOLV/PM</b> <b>CLV/PM</b> <b>EZOLV</b> Sets the horizontal axis used to show the monitor that was set in o1-25 as a bar graph. This parameter is only available with an LCD keypad.	0 (0 - 2)

### 0 : +/- Area ( - o1-44 ~ o1-44 )

### 1 : + Area ( 0 ~ o1-44 )

### 2 : - Area ( - o1-44 ~ 0 )

■ **o1-44: 2nd Monitor Area Setting**

No. (Hex.)	Name	Description	Default (Range)
o1-44 (11C4) RUN	2nd Monitor Area Setting	<b>V/f</b> <b>CL-V/f</b> <b>OLV</b> <b>CLV</b> <b>AOLV</b> <b>OLV/PM</b> <b>AOLV/PM</b> <b>CLV/PM</b> <b>EZOLV</b> Sets the horizontal axis value used to display the monitor that was set in o1-25 [Custom Monitor 2] as a bar graph. This parameter is only available with an LCD keypad.	100.0% (0.0 - 100.0%)

■ **o1-45: 3rd Monitor Area Selection**

No. (Hex.)	Name	Description	Default (Range)
o1-45 (11C5) RUN	3rd Monitor Area Selection	<b>V/f</b> <b>CL-V/f</b> <b>OLV</b> <b>CLV</b> <b>AOLV</b> <b>OLV/PM</b> <b>AOLV/PM</b> <b>CLV/PM</b> <b>EZOLV</b> Sets the horizontal axis used to show the monitor that was set in o1-26 as a bar graph. This parameter is only available with an LCD keypad.	0 (0 - 2)

0 : +/- Area ( - o1-46 ~ o1-46 )

1 : + Area ( 0 ~ o1-46 )

2 : - Area ( - o1-46 ~ 0 )

■ **o1-46: 3rd Monitor Area Setting**

No. (Hex.)	Name	Description	Default (Range)
o1-46 (11C6) RUN	3rd Monitor Area Setting	<b>V/f</b> <b>CL-V/f</b> <b>OLV</b> <b>CLV</b> <b>AOLV</b> <b>OLV/PM</b> <b>AOLV/PM</b> <b>CLV/PM</b> <b>EZOLV</b> Sets the horizontal axis value used to display the monitor that was set in o1-26 [Custom Monitor 3] as a bar graph. This parameter is only available with an LCD keypad.	100.0% (0.0 - 100.0%)

■ **o1-47: Trend Plot 1 Scale Minimum Value**

No. (Hex.)	Name	Description	Default (Range)
o1-47 (11C7) RUN	Trend Plot 1 Scale Minimum Value	<b>V/f</b> <b>CL-V/f</b> <b>OLV</b> <b>CLV</b> <b>AOLV</b> <b>OLV/PM</b> <b>AOLV/PM</b> <b>CLV/PM</b> <b>EZOLV</b> Sets the minimum value for the vertical axis used to display the monitor that was set in o1-24 [Custom Monitor 1] as a trend plot. This parameter is only available with an LCD keypad.	100% (-300 - +300%)

■ **o1-48: Trend Plot 1 Scale Maximum Value**

No. (Hex.)	Name	Description	Default (Range)
o1-48 (11C8) RUN	Trend Plot 1 Scale Maximum Value	<b>V/f</b> <b>CL-V/f</b> <b>OLV</b> <b>CLV</b> <b>AOLV</b> <b>OLV/PM</b> <b>AOLV/PM</b> <b>CLV/PM</b> <b>EZOLV</b> Sets the maximum value for the vertical axis used to display the monitor that was set in o1-24 [Custom Monitor 1] as a trend plot. This parameter is only available with an LCD keypad.	100.0% (-99.9 - +300.0%)

■ **o1-49: Trend Plot 2 Scale Minimum Value**

No. (Hex.)	Name	Description	Default (Range)
o1-49 (11C9) RUN	Trend Plot 2 Scale Minimum Value	<b>V/f</b> <b>CL-V/f</b> <b>OLV</b> <b>CLV</b> <b>AOLV</b> <b>OLV/PM</b> <b>AOLV/PM</b> <b>CLV/PM</b> <b>EZOLV</b> Sets the minimum value for the vertical axis used to display the monitor that was set in o1-25 [Custom Monitor 2] as a trend plot. This parameter is only available with an LCD keypad.	100% (-300 - +300%)



### ■ o1-50: Trend Plot 2 Scale Maximum Value

No. (Hex.)	Name	Description	Default (Range)
o1-50 (11CA) RUN	Trend Plot 2 Scale Maximum Value	<b>V/f</b> <b>CL-V/f</b> <b>OLV</b> <b>CLV</b> <b>AOLV</b> <b>OLV/PM</b> <b>AOLV/PM</b> <b>CLV/PM</b> <b>EZOLV</b> Sets the maximum value for the vertical axis used to display the monitor that was set in o1-25 [Custom Monitor 2] as a trend plot. This parameter is only available with an LCD keypad.	100.0% (-99.9 - +300.0%)

### ■ o1-51: Trend Plot Time Scale Setting

No. (Hex.)	Name	Description	Default (Range)
o1-51 (11CB) RUN	Trend Plot Time Scale Setting	<b>V/f</b> <b>CL-V/f</b> <b>OLV</b> <b>CLV</b> <b>AOLV</b> <b>OLV/PM</b> <b>AOLV/PM</b> <b>CLV/PM</b> <b>EZOLV</b> Sets the time scale (horizontal axis) to display the trend plot. When you change this setting, the drive automatically adjusts the data sampling time. This parameter is only available with an LCD keypad.	300 s (1 - 3600 s)

### ■ o1-55: Analog Gauge Area Selection

No. (Hex.)	Name	Description	Default (Range)
o1-55 (11EE) RUN	Analog Gauge Area Selection	<b>V/f</b> <b>CL-V/f</b> <b>OLV</b> <b>CLV</b> <b>AOLV</b> <b>OLV/PM</b> <b>AOLV/PM</b> <b>CLV/PM</b> <b>EZOLV</b> Sets the range used to display the monitor set in o1-24 [Custom Monitor 1] as an analog gauge. This parameter is only available with an LCD keypad.	1 (0, 1)

0 : +/- Area ( - o1-56 ~ o1-56 )

1 : + Area ( 0 ~ o1-56 )

### ■ o1-56: Analog Gauge Area Setting

No. (Hex.)	Name	Description	Default (Range)
o1-56 (11EF) RUN	Analog Gauge Area Setting	<b>V/f</b> <b>CL-V/f</b> <b>OLV</b> <b>CLV</b> <b>AOLV</b> <b>OLV/PM</b> <b>AOLV/PM</b> <b>CLV/PM</b> <b>EZOLV</b> Sets the value used to display the monitor set in o1-24 [Custom Monitor 1] as an analog meter. This parameter is only available with an LCD keypad.	100.0% (0.0 - 100.0%)

## ◆ o2: Keypad Operation


### ■ o2-01: LO/RE Key Function Selection

No. (Hex.)	Name	Description	Default (Range)
o2-01 (0505)	LO/RE Key Function Selection	<b>V/f</b> <b>CL-V/f</b> <b>OLV</b> <b>CLV</b> <b>AOLV</b> <b>OLV/PM</b> <b>AOLV/PM</b> <b>CLV/PM</b> <b>EZOLV</b> Sets the function that lets the drive switch between LOCAL and REMOTE Modes using the <b>LO/RE</b> button.	1 (0, 1)

#### 0 : Disabled

You cannot use **LO/RE** to switch between LOCAL and REMOTE Modes.

#### 1 : Enabled

You can use **LO/RE** to switch between LOCAL and REMOTE Modes when the drive is stopped. When LOCAL Mode is selected,  on the keypad will come on.

**WARNING! Sudden Movement Hazard.** The drive may start unexpectedly if switching control sources when setting b1-07 = 1 [LOCAL/REMOTE Run Selection = Accept Existing RUN Command]. Clear all personnel from rotating machinery and electrical connections prior to switching control sources. Failure to comply may cause death or serious injury.

**WARNING! Sudden Movement Hazard.** Fully examine all mechanical and electrical connections before you change o2-01 [LO/RE Key Function Selection] or b1-07 [LOCAL/REMOTE Run Selection]. If b1-07 = 1 [Accept Existing RUN Command] and there is an active Run command when you switch from LOCAL to REMOTE Mode, the drive can start suddenly. Failure to obey can cause serious injury or death.

Table 11.77 Function Settings via o2-01 through b1-07

<b>LO/RE</b> Function Selection	LOCAL/REMOTE Run Selection	Switching from LOCAL Mode to REMOTE Mode	Switching from REMOTE Mode to LOCAL Mode
o2-01 = 0 [Disabled]	b1-07 = 0 [Disregard Existing RUN Command]	The drive will not switch modes.	The drive will not switch modes.
	b1-07 = 1 [Accept Existing RUN Command]		
o2-01 = 1 [Enabled]	b1-07 = 0 [Disregard Existing RUN Command]	The drive will not start operating although the Run command is active. When you set Run command to active again, the drive will start to run.	The drive cannot operate because the Run command is not enabled.
	b1-07 = 1 [Accept Existing RUN Command]	When the Run command is active, the drive will start to run immediately when the mode switches from LOCAL to REMOTE.	The drive cannot operate because the Run command is not enabled.

■ o2-02: STOP Key Function Selection

No. (Hex.)	Name	Description	Default (Range)
o2-02 (0506)	STOP Key Function Selection	<p>Sets the function to stop the drive with the  button on the keypad when the Run command source for the drive is REMOTE (external) and not assigned to the keypad.</p>	1 (0, 1)

0 : Disabled

1 : Enabled

stays enabled when the Run command source has not been assigned to the keypad.

To start the drive again after you push to stop operation, turn the external Run command OFF and ON again.

■ o2-03: User Parameter Default Value

No. (Hex.)	Name	Description	Default (Range)
o2-03 (0507)	User Parameter Default Value	<p>Sets the function to keep the settings of changed parameters as user parameter defaults to use during initialization.</p>	0 (0 - 2)

When you set this parameter to 1, the drive saves changed parameter settings as user parameter setting values in a part of the memory that is isolated from drive parameters.

When you set *A1-03 = 1110* [Initialize Parameters = User initialization] to initialize the drive, the drive resets the internal parameter setting values to those user parameter setting values.

0 : No change

1 : Set defaults

Saves changed parameter settings as user-set default for User Initialization.

Set *o2-03 = 1* [Set defaults], then push on the keypad to save the user parameter setting values. After the drive saves the setting value, *o2-03* automatically resets to 0.

2 : Clear all

Deletes all of the saved user parameter setting values.

To delete the user parameter setting values, set this parameter to 2 and push on the keypad. The drive will automatically reset *o2-03* to 0. If you delete the user parameter setting values, you cannot set *A1-03 = 1110* to initialize parameters.

## ■ o2-04: Drive Model (KVA) Selection

No. (Hex.)	Name	Description	Default (Range)
o2-04 (0508)	Drive Model (KVA) Selection	<div style="display: flex; justify-content: space-between; font-size: 0.8em; font-weight: bold; margin-bottom: 5px;"> <span>V/f</span> <span>CL-V/f</span> <span>OLV</span> <span>CLV</span> <span>AOLV</span> <span>OLV/PM</span> <span>AOLV/PM</span> <span>CLV/PM</span> <span>EZOLV</span> </div> Sets the Drive Model code. Set this parameter after replacing the control board.	Determined by the drive (-)

**NOTICE:** Set o2-04 [Drive Model Selection] correctly. Failure to obey will decrease drive performance, cause the protection function to operate incorrectly, and cause damage to the drive.


**Note:**

When the setting value of o2-04 changes, related parameter setting values also change. Refer to [Defaults by Drive Model and Duty Rating ND/HD on page 623](#) for more information.


These tables list the relation between o2-04 setting values and drive models.

o2-04 Setting	Drive Model	o2-04 Setting	Drive Model
62	2004	95	4007
63	2006	96	4009
65	2010	97	4012
66	2012	99	4018
67	2018	9A	4023
68	2021	9C	4031
6A	2030	9D	4038
6B	2042	9E	4044
6D	2056	9F	4060
6E	2070	A1	4075
6F	2082	A2	4089
70	2110	A3	4103
72	2138	A4	4140
73	2169	A5	4168
74	2211	A6	4208
75	2257	A7	4250
76	2313	A8	4296
77	2360	A9	4371
78	2415	AA	4389
92	4002	AC	4453
93	4004	AD	4568
94	4005	AE	4675




## ■ o2-05: Home Mode Freq Ref Entry Mode

No. (Hex.)	Name	Description	Default (Range)
o2-05 (0509)	Home Mode Freq Ref Entry Mode	<div style="display: flex; justify-content: space-between; font-size: 0.8em; font-weight: bold; margin-bottom: 5px;"> <span>V/f</span> <span>CL-V/f</span> <span>OLV</span> <span>CLV</span> <span>AOLV</span> <span>OLV/PM</span> <span>AOLV/PM</span> <span>CLV/PM</span> <span>EZOLV</span> </div> Sets the function that makes it necessary to push the  button to change the frequency reference value with the keypad when in Drive Mode.	0 (0, 1)










### 0 : ENTER Key Required

You must push  to use the keypad to change the frequency reference value.

### 1 : Immediate / MOP-style

The frequency reference changes when you enter it with the keypad. This then changes the output frequency. It is not necessary to push . The drive keeps the frequency reference for 5 seconds after you use  and  on the keypad to change the frequency reference value.

**■ o2-06: Keypad Disconnect Detection**

No. (Hex.)	Name	Description	Default (Range)
o2-06 (050A)	Keypad Disconnect Detection	         Sets the function that stops the drive if you disconnect the keypad connection cable from the drive or if you damage the cable while the keypad is the Run command source.	Determined by o2-09 (0, 1)

This parameter continues to operate if the keypad installed to the drive becomes disconnected.

This parameter is enabled in these conditions:

- When  $b1-02 = 0$  [Run Command Selection 1 = Keypad] or  $b1-16 = 0$  [Run Command Selection 2 = Keypad]
- In LOCAL Mode










**0 : Disabled**

The drive continues operation when it detects a keypad disconnection.

**1 : Enabled**

The drive stops operation, detects  $oPr$  [Keypad Connection Fault], and the motor coasts to stop when the drive detects a keypad disconnection.

**■ o2-07: Keypad RUN Direction @ Power-up**

No. (Hex.)	Name	Description	Default (Range)
o2-07 (0527)	Keypad RUN Direction @ Power-up	         Sets the direction of motor rotation when the drive is energized and the keypad is the Run command source.	0 (0, 1)

This parameter is enabled in these conditions:

- When  $b1-02 = 0$  [Run Command Selection 1 = Keypad] or  $b1-16 = 0$  [Run Command Selection 2 = Keypad]
- In LOCAL Mode










**0 : Forward**

**1 : Reverse**

**■ o2-09: Region Code**

No. (Hex.)	Name	Description	Default (Range)
o2-09 (050D)	Region Code	-	-

**■ o2-23: External 24V Powerloss Detection**

No. (Hex.)	Name	Description	Default (Range)
o2-23 (11F8)	External 24V Powerloss Detection	         Sets the function to give a warning when the backup external 24 V power supply turns off when the main circuit power supply is in operation.	0 (0, 1)

**Note:**

The drive will not run when it is operating from one 24-V external power supply.

**0 : Disabled**

The drive does not detect the loss of the 24-V external power supply.

**1 : Enabled**

The keypad shows the  $L24v$  [Ext. 24-V Power Supply Lost] indicator when the drive detects the loss of the 24-V external power supply.

**Note:**

The minor fault signal is not output from  $H2-xx = 10$  [Multi-Function Digital Out = Minor Fault].

### ■ o2-24: LED Light Function Selection

No. (Hex.)	Name	Description	Default (Range)
o2-24 (11FE)	LED Light Function Selection	<b>V/f</b> <b>CL-V/f</b> <b>OLV</b> <b>CLV</b> <b>AOLV</b> <b>OLV/PM</b> <b>AOLV/PM</b> <b>CLV/PM</b> <b>EZOLV</b> Sets the function to show the LED status rings and keypad LED lamps.	0 (0 - 2)

**0 : Enable Status Ring & Keypad LED**

**1 : LED Status Ring Disable**

**2 : Keypad LED Light Disable**

### ■ o2-26: Alarm display at ext. 24V power

No. (Hex.)	Name	Description	Default (Range)
o2-26 (1563)	Alarm display at ext. 24V power	<b>V/f</b> <b>CL-V/f</b> <b>OLV</b> <b>CLV</b> <b>AOLV</b> <b>OLV/PM</b> <b>AOLV/PM</b> <b>CLV/PM</b> <b>EZOLV</b> When you connect a backup external 24 V power supply, this parameter sets the function to trigger an alarm when the main circuit power supply voltage decreases.	0 (0, 1)

**0 : Disabled**

The drive will not detect  $EP24v$  [External Power 24V Supply] if the main circuit power supply voltage decreases. The [Ready] light on the LED Status Ring flashes quickly to identify that drive operation is not possible.

**1 : Enabled**

The drive detects  $EP24v$  when the main circuit power supply voltage decreases.

**Note:**

The minor fault signal is not output from  $H2-xx = 10$  [Multi-Function Digital Out = Minor Fault].

### ■ o2-27: bCE Detection Selection

No. (Hex.)	Name	Description	Default (Range)
o2-27 (1565)	bCE Detection Selection	<b>V/f</b> <b>CL-V/f</b> <b>OLV</b> <b>CLV</b> <b>AOLV</b> <b>OLV/PM</b> <b>AOLV/PM</b> <b>CLV/PM</b> <b>EZOLV</b> Sets drive operation if the Bluetooth device is disconnected when you operate the drive in Bluetooth Mode.	3 (0 - 4)

**0 : Ramp to Stop**

**1 : Coast to Stop**

**2 : Fast Stop (Use C1-09)**

**3 : Alarm Only**

**4 : No Alarm Display**

## ◆ o3: Copy Function

$o3$  parameters set the operation of the parameter backup function.

### ■ o3-01: Copy Keypad Function Selection

No. (Hex.)	Name	Description	Default (Range)
o3-01 (0515)	Copy Keypad Function Selection	<b>V/f</b> <b>CL-V/f</b> <b>OLV</b> <b>CLV</b> <b>AOLV</b> <b>OLV/PM</b> <b>AOLV/PM</b> <b>CLV/PM</b> <b>EZOLV</b> Sets the function that saves and copies drive parameters to a different drive with the keypad.	0 (0 - 4)

**0 : Copy Select**

**1 : Backup (drive → keypad)**

The parameter setting values are read from the drive and saved in the keypad.

**2 : Restore (keypad → drive)**

Copies the parameter setting values saved in the keypad to a different drive.

### 3 : Verify (check for mismatch)

Makes sure that the parameter setting values in the drive agree with the parameters saved in the keypad.

### 4 : Erase (backup data of keypad)

Deletes the parameter setting values saved in the keypad.

## ■ o3-02: Copy Allowed Selection

No. (Hex.)	Name	Description	Default (Range)
o3-02 (0516)	Copy Allowed Selection	<b>V/f</b> <b>CL-V/f</b> <b>OLV</b> <b>CLV</b> <b>AOLV</b> <b>OLV/PM</b> <b>AOLV/PM</b> <b>CLV/PM</b> <b>EZOLV</b> Sets the copy function when <i>o3-01</i> = 1 [ <i>Copy Keypad Function Selection = Backup (drive → keypad)</i> ].	0 (0, 1)

#### Note:

When you select [Parameter Backup] on the keypad menu screen to do the backup function, the drive automatically sets *o3-02* = 1.

### 0 : Disabled

### 1 : Enabled

## ■ o3-04: Select Backup/Restore Location

No. (Hex.)	Name	Description	Default (Range)
o3-04 (0B3E)	Select Backup/Restore Location	<b>V/f</b> <b>CL-V/f</b> <b>OLV</b> <b>CLV</b> <b>AOLV</b> <b>OLV/PM</b> <b>AOLV/PM</b> <b>CLV/PM</b> <b>EZOLV</b> Sets the storage location for drive parameters when you back up and restore parameters. This parameter is only available with an LCD keypad.	0 (0 - 3)

You can use the LCD keypad to make a maximum of 4 parameter backup sets.

### 0 : Memory Location 1

### 1 : Memory Location 2

### 2 : Memory Location 3

### 3 : Memory Location 4

## ■ o3-05: Select Items to Backup/Restore

No. (Hex.)	Name	Description	Default (Range)
o3-05 (0BDA)	Select Items to Backup/Restore	<b>V/f</b> <b>CL-V/f</b> <b>OLV</b> <b>CLV</b> <b>AOLV</b> <b>OLV/PM</b> <b>AOLV/PM</b> <b>CLV/PM</b> <b>EZOLV</b> Sets which parameters are backed up, restored, and referenced. This parameter is only available with an LED keypad.	0 (0, 1)

### 0 : Standard Parameters

### 1 : Standard + DWEZ Parameters

#### Note:

- The *qx-xx* and *rx-xx* parameters appear when *A1-07* = 1 or 2 [*DriveWorksEZ Function Selection = DWEZ Enabled or Enabled/Disabled w/Digital Input*].
- When *o3-05* = 1, parameters are only restored and verified.

## ■ o3-06: Auto Parameter Backup Selection

No. (Hex.)	Name	Description	Default (Range)
o3-06 (0BDE)	Auto Parameter Backup Selection	<b>V/f</b> <b>CL-V/f</b> <b>OLV</b> <b>CLV</b> <b>AOLV</b> <b>OLV/PM</b> <b>AOLV/PM</b> <b>CLV/PM</b> <b>EZOLV</b> Sets the function that automatically backs up parameters. This parameter is only available when using an LCD keypad.	1 (0, 1)

When you connect the drive and keypad, parameters set to the drive are automatically backed up to the keypad as specified by the setting of parameters *o3-06* and *o3-07*.

### 0 : Disabled

### 1 : Enabled

**Note:**

When you replace the LCD keypad then energize the drive, the keypad shows the restore operation screen automatically to restore the drive configuration with the parameters backed up to the LCD keypad. If you connect an LCD keypad that does not have parameter backup data, the keypad will not show the restore operation screen.

### ■ o3-07: Auto Parameter Backup Interval

No. (Hex.)	Name	Description	Default (Range)
o3-07 (0BDF)	Auto Parameter Backup Interval	<b>V/f</b> <b>CL-V/f</b> <b>OLV</b> <b>CLV</b> <b>AOLV</b> <b>OLV/PM</b> <b>AOLV/PM</b> <b>CLV/PM</b> <b>EZOLV</b> Sets the interval at which the automatic parameter backup function saves parameters from the drive to the keypad.	1 (0 - 3)

The drive saves parameter settings to the keypad at these times:

1. After you energize the drive and the auto backup period passes.
2. When you use ROM enter or the keypad to change parameters, the drive saves those changes in the drive, waits for the auto backup period to pass, then saves those parameters in the keypad.

**NOTICE:** Think about this limit when you set the auto backup period. You can write data to the keypad a maximum of 100,000 times. If you write data to the keypad more than 100,000 times, it can cause data access errors and keypad failure.

**0 : Every 10 minutes**

**1 : Every 30 minutes**

**2 : Every 60 minutes**

**3 : Every 12 hours**

### ◆ o4: Maintenance Mon Settings

*o4* parameters set the expected service life to help you know when to replace parts. The drive will show an alarm to tell you when the replacement part interval is near.

#### ■ o4-01: Elapsed Operating Time Setting

No. (Hex.)	Name	Description	Default (Range)
o4-01 (050B)	Elapsed Operating Time Setting	<b>V/f</b> <b>CL-V/f</b> <b>OLV</b> <b>CLV</b> <b>AOLV</b> <b>OLV/PM</b> <b>AOLV/PM</b> <b>CLV/PM</b> <b>EZOLV</b> Sets the initial value of the cumulative drive operation time in 10-hour units.	0 h (0 - 9999 h)

When you select *o4-01* on the keypad, it will show the current value of *U4-01* in units of 10 hours (h). When you change the setting of *o4-01* through the monitor, the *U4-01* count starts again as specified by the setting of *o4-01*.

**Note:**

Set this parameter in 10-hour (h) units. When *o4-01* = 30, *U4-01* [Cumulative Ope Time] = 300 h.

#### ■ o4-02: Elapsed Operating Time Selection

No. (Hex.)	Name	Description	Default (Range)
o4-02 (050C)	Elapsed Operating Time Selection	<b>V/f</b> <b>CL-V/f</b> <b>OLV</b> <b>CLV</b> <b>AOLV</b> <b>OLV/PM</b> <b>AOLV/PM</b> <b>CLV/PM</b> <b>EZOLV</b> Sets the condition that counts the cumulative operation time.	0 (0, 1)

#### 0 : U4-01 Shows Total Power-up Time

Counts the time from when the drive is energized to when it is de-energized.

#### 1 : U4-01 Shows Total RUN Time

Counts the time that the drive outputs voltage.

#### ■ o4-03: Fan Operation Time Setting

No. (Hex.)	Name	Description	Default (Range)
o4-03 (050E)	Fan Operation Time Setting	<b>V/f</b> <b>CL-V/f</b> <b>OLV</b> <b>CLV</b> <b>AOLV</b> <b>OLV/PM</b> <b>AOLV/PM</b> <b>CLV/PM</b> <b>EZOLV</b> Sets the value from which to start the cumulative drive cooling fan operation time in 10-hour units.	0 h (0 - 9999 h)

## 11.11 o: Keypad-Related Settings

Use monitor *U4-03 [Cooling Fan Ope Time]* to view the total operation time of the cooling fan. When you replace a cooling fan, set *o4-03 = 0* and reset the value of *U4-03*. Select *o4-03* on the keypad to show the current value of *U4-03* in 10-hour (h) units. If you use the monitor to change the *o4-03* setting, the recount of *U4-03* starts with the *o4-03* setting.

**Note:**

The drive sets *o4-03* in 10-hour (h) units. When *o4-03 = 30*, *U4-03 [Cooling Fan Ope Time]* will show "300 h".

### ■ o4-05: Capacitor Maintenance Setting

No. (Hex.)	Name	Description	Default (Range)
o4-05 (051D)	Capacitor Maintenance Setting	<b>V/f</b> <b>CL-V/f</b> <b>OLV</b> <b>CLV</b> <b>AOLV</b> <b>OLV/PM</b> <b>AOLV/PM</b> <b>CLV/PM</b> <b>EZOLV</b> Sets the <i>U4-05 [CapacitorMaintenance]</i> monitor value.	0% (0 - 150%)

When you replace a drive, set *o4-05 = 0* to reset the value of *U4-05*. When the *o4-05* setting changes, the count of *U4-05* starts again as specified by the setting of *o4-05*. After you complete the configuration, the setting value of *o4-05* automatically resets to 0.

**Note:**

The maintenance period changes for different operating environments.

### ■ o4-07: Softcharge Relay Maintenance Set

No. (Hex.)	Name	Description	Default (Range)
o4-07 (0523)	Softcharge Relay Maintenance Set	<b>V/f</b> <b>CL-V/f</b> <b>OLV</b> <b>CLV</b> <b>AOLV</b> <b>OLV/PM</b> <b>AOLV/PM</b> <b>CLV/PM</b> <b>EZOLV</b> Sets the <i>U4-06 [SChgBypassRelayMaint]</i> monitor value.	0% (0 - 150%)

When you replace a drive, set *o4-07 = 0* to reset the value of *U4-06*. When the *o4-07* setting changes the count of *U4-06* starts again as specified by the setting of *o4-07*. After you complete the configuration, the setting value of *o4-07* automatically resets to 0.

**Note:**

The maintenance period changes for different operating environments.

### ■ o4-09: IGBT Maintenance Setting

No. (Hex.)	Name	Description	Default (Range)
o4-09 (0525)	IGBT Maintenance Setting	<b>V/f</b> <b>CL-V/f</b> <b>OLV</b> <b>CLV</b> <b>AOLV</b> <b>OLV/PM</b> <b>AOLV/PM</b> <b>CLV/PM</b> <b>EZOLV</b> Sets the <i>U4-07 [IGBT Maintenance]</i> monitor value.	0% (0 - 150%)

When you replace a drive, set *o4-09 = 0* to reset the value of *U4-07*. When the *o4-09* setting changes the count of *U4-07* starts again as specified by the setting of *o4-09*. After you complete the configuration, the setting value of *o4-09* automatically resets to 0.

**Note:**

The maintenance period changes for different operating environments.

### ■ o4-11: Fault Trace/History Init (U2/U3)

No. (Hex.)	Name	Description	Default (Range)
o4-11 (0510)	Fault Trace/History Init (U2/U3)	<b>V/f</b> <b>CL-V/f</b> <b>OLV</b> <b>CLV</b> <b>AOLV</b> <b>OLV/PM</b> <b>AOLV/PM</b> <b>CLV/PM</b> <b>EZOLV</b> Resets the records of Monitors <i>U2-xx [Fault Trace]</i> and <i>U3-xx [Fault History]</i> .	0 (0, 1)

**Note:**

When you initialize the drive with *A1-03 [Initialize Parameters]*, the drive will not reset the records for *U2-xx* and *U3-xx*.

#### 0 : Disabled

Keeps the records of Monitors *U2-xx* and *U3-xx*.

#### 1 : Enabled

Resets the records for Monitors *U2-xx* and *U3-xx*. After the reset, the drive automatically resets *o4-11* to 0.



## ■ o4-12: kWh Monitor Initialization

No. (Hex.)	Name	Description	Default (Range)
o4-12 (0512)	kWh Monitor Initialization	<b>V/f</b> <b>CL-V/f</b> <b>OLV</b> <b>CLV</b> <b>AOLV</b> <b>OLV/PM</b> <b>AOLV/PM</b> <b>CLV/PM</b> <b>EZOLV</b> Resets the monitor values for U4-10 [kWh, Lower 4 Digits] and U4-11 [kWh, Upper 5 Digits].	0 (0, 1)

### Note:

When you initialize the drive with A1-03 [Initialize Parameters], the drive will not reset U4-10 and U4-11.

### 0 : No Reset

Keeps the monitor values for U4-10 and U4-11.

### 1 : Reset

Resets the values of U4-10 and U4-11. After the reset, the drive automatically resets o4-12 to 0.

## ■ o4-13: RUN Command Counter @ Initialize

No. (Hex.)	Name	Description	Default (Range)
o4-13 (0528)	RUN Command Counter @ Initialize	<b>V/f</b> <b>CL-V/f</b> <b>OLV</b> <b>CLV</b> <b>AOLV</b> <b>OLV/PM</b> <b>AOLV/PM</b> <b>CLV/PM</b> <b>EZOLV</b> Resets the monitor values for U4-02 [Num of Run Commands], U4-24 [Number of Runs (Low)], and U4-25 [Number of Runs(High)].	0 (0, 1)

### 0 : No Reset

Keeps the monitor values for U4-02, U4-24, and U4-25.

### 1 : Reset

Resets the values of U4-02, U4-24, and U4-25. After the reset, the drive automatically resets o4-13 to 0.

## ■ o4-22: Time Format

No. (Hex.)	Name	Description	Default (Range)
o4-22 (154F) RUN	Time Format	<b>V/f</b> <b>CL-V/f</b> <b>OLV</b> <b>CLV</b> <b>AOLV</b> <b>OLV/PM</b> <b>AOLV/PM</b> <b>CLV/PM</b> <b>EZOLV</b> Sets the time display format. This parameter is only available when using an LCD keypad.	0 (0 - 2)

Sets the display of the time shown in the upper-left of the LCD keypad screen.

### 0 : 24 Hour Clock

### 1 : 12 Hour Clock

### 2 : 12 Hour JP Clock

## ■ o4-23: Date Format

No. (Hex.)	Name	Description	Default (Range)
o4-23 (1550) RUN	Date Format	<b>V/f</b> <b>CL-V/f</b> <b>OLV</b> <b>CLV</b> <b>AOLV</b> <b>OLV/PM</b> <b>AOLV/PM</b> <b>CLV/PM</b> <b>EZOLV</b> Sets the date display format. This parameter is only available when using an LED keypad.	0 (0 - 2)

Sets the date format that the drive uses for the fault history and other records.

### 0 : YYYY/MM/DD

### 1 : DD/MM/YYYY

### 2 : MM/DD/YYYY

### Note:

The Fault History in the Monitor Mode shows when faults occurred. Refer to [Show Fault History on page 176](#) for more information.

### ■ o4-24: bAT Detection Selection

No. (Hex.)	Name	Description	Default (Range)
o4-24 (310F) RUN	bAT Detection Selection	<div style="display: flex; justify-content: space-between; font-size: small;"> <span>V/f</span> <span>CL-V/f</span> <span>OLV</span> <span>CLV</span> <span>AOLV</span> <span>OLV/PM</span> <span>AOLV/PM</span> <span>CLV/PM</span> <span>EZOLV</span> </div> Sets operation when the drive detects <i>bAT</i> [Keypad Battery Low Voltage] and <i>TiM</i> [Keypad Time Not Set].	0 (0 - 2)

#### 0 : Disable

The drive will not detect *bAT* or *TiM*.

#### 1 : Enable (Alarm Detected)

*TiM* or *bAT* shows on the keypad, and operation continues. The output terminal set for Alarm [H2-01 to H2-03 = 10] activates.

#### 2 : Enable (Fault Detected)

The drive output shuts off and the motor coasts to stop. Fault relay output terminal MA-MC activates, and MB-MC deactivates.

### ◆ o5: Log Function

The data log function saves drive status information as a CSV file in the micro SD memory card in the keypad. *Monitors Ux-xx* are the source of data log information. You can record a maximum of 10 monitors.

Change the LCD keypad screen from the main menu to the Diagnostic Tools screen and select the data log function. Set the number of the monitor to record and the sampling time, then start to record the data log.

Table 11.78 Setting Parameters for Data Log Items

No.	Name	Default	Data Log Monitors
o5-03	Log Monitor Data 1	101	U1-01 [Frequency Reference]
o5-04	Log Monitor Data 2	102	U1-02 [Output Frequency]
o5-05	Log Monitor Data 3	103	U1-03 [Output Current]
o5-06	Log Monitor Data 4	107	U1-07 [DC Bus Voltage]
o5-07	Log Monitor Data 5	108	U1-08 [Output Power]
o5-08	Log Monitor Data 6	000	Not selected
o5-09	Log Monitor Data 7	000	Not selected
o5-10	Log Monitor Data 8	000	Not selected
o5-11	Log Monitor Data 9	000	Not selected
o5-12	Log Monitor Data 10	000	Not selected

**NOTICE:** Do not de-energize the drive or disconnect the keypad from the drive during log transfer communication. Failure to obey can cause the log function to fail after you restore power or connect the keypad.

#### Note:

You can use a Micro SDHC card a maximum of 32 GB capacity.

### ■ Log File Specifications

Item	Specification
File storage location	A folder called [Log_File] is created in the root directory of the micro SD card.
Filename	GLOG0xxx.csv <b>Note:</b> [xxx] identifies a 3-digit decimal number
Maximum number of files	999 (GLOG0001.csv through GLOG0999.csv)
Character code	ASCII code
Line break code	<CR><LF>





No.	Item	Number of Characters	Description
15	Encoding data	4	Encoding data for log monitor data 1 through 10 (Hex.) Bits 0 through 9 show the encoding of log monitor data 1 through 10. A bit value of 1 shows that the data represents a negative value. (Log monitor data 1 through 10 is absolute value data without encoding) Example when log monitor data 2, 5, and 8 show negative values: Bits 1, 4, and 7 have values of 1, and the encoding data = 0010010010 (Bin.) = 0092 (Hex.)
16	Row number	6	Row number (Hex.) in the data log file

### ■ o5-01: Log Start/Stop Selection

No. (Hex.)	Name	Description	Default (Range)
o5-01 (1551) RUN	Log Start/Stop Selection	<b>V/f</b> <b>CL-V/f</b> <b>OLV</b> <b>CLV</b> <b>AOLV</b> <b>OLV/PM</b> <b>AOLV/PM</b> <b>CLV/PM</b> <b>EZOLV</b> Sets the data log function. This parameter is only available on an LCD keypad.	0 (0 - 1)

#### 0 : OFF

Stops the data log.

#### 1 : ON

Starts the data log as specified by the sampling cycle set in o5-02 [Log Sampling Interval].

### ■ o5-02: Log Sampling Interval

No. (Hex.)	Name	Description	Default (Range)
o5-02 (1552) RUN	Log Sampling Interval	<b>V/f</b> <b>CL-V/f</b> <b>OLV</b> <b>CLV</b> <b>AOLV</b> <b>OLV/PM</b> <b>AOLV/PM</b> <b>CLV/PM</b> <b>EZOLV</b> Sets the data log sampling cycle. This parameter is only available on an LCD keypad.	1000 ms (100 - 6000 ms)

### ■ o5-03: Log Monitor Data 1

No. (Hex.)	Name	Description	Default (Range)
o5-03 (1553) RUN	Log Monitor Data 1	<b>V/f</b> <b>CL-V/f</b> <b>OLV</b> <b>CLV</b> <b>AOLV</b> <b>OLV/PM</b> <b>AOLV/PM</b> <b>CLV/PM</b> <b>EZOLV</b> Sets the data log monitor. This parameter is only available on an LCD keypad.	101 (000,101 - 855)

#### Note:

Set the log data with values 101 to 999 [U1-01 to U9-99].

For example, to show U1-05 [Motor Speed], set o5-03 = 105. When it is not necessary to set data log monitors, set this parameter to 000. You cannot set U2 monitors [Fault Trace] or U3 Monitors [Fault History].

### ■ o5-04: Log Monitor Data 2

No. (Hex.)	Name	Description	Default (Range)
o5-04 (1554) RUN	Log Monitor Data 2	<b>V/f</b> <b>CL-V/f</b> <b>OLV</b> <b>CLV</b> <b>AOLV</b> <b>OLV/PM</b> <b>AOLV/PM</b> <b>CLV/PM</b> <b>EZOLV</b> Sets the data log monitor. This parameter is only available on an LCD keypad.	102 (000,101 - 855)

#### Note:

Set the log data with values 101 to 999 [U1-01 to U9-99].

For example, to show U1-05 [Motor Speed], set o5-04 = 105. When it is not necessary to set data log monitors, set this parameter to 000. You cannot set U2 monitors [Fault Trace] or U3 Monitors [Fault History].

### ■ o5-05: Log Monitor Data 3

No. (Hex.)	Name	Description	Default (Range)
o5-05 (1555) RUN	Log Monitor Data 3	<div style="display: flex; justify-content: space-between; font-size: 0.8em; font-weight: bold; margin-bottom: 5px;"> <span>V/f</span> <span>CL-V/f</span> <span>OLV</span> <span>CLV</span> <span>AOLV</span> <span>OLV/PM</span> <span>AOLV/PM</span> <span>CLV/PM</span> <span>EZOLV</span> </div> Sets the data log monitor. This parameter is only available on an LCD keypad.	103 (000,101 - 855)

**Note:**

Set the log data with values 101 to 999 [U1-01 to U9-99].

For example, to show U1-05 [Motor Speed], set o5-05 = 105. When it is not necessary to set data log monitors, set this parameter to 000. You cannot set U2 monitors [Fault Trace] or U3 Monitors [Fault History].

### ■ o5-06: Log Monitor Data 4

No. (Hex.)	Name	Description	Default (Range)
o5-06 (1556) RUN	Log Monitor Data 4	<div style="display: flex; justify-content: space-between; font-size: 0.8em; font-weight: bold; margin-bottom: 5px;"> <span>V/f</span> <span>CL-V/f</span> <span>OLV</span> <span>CLV</span> <span>AOLV</span> <span>OLV/PM</span> <span>AOLV/PM</span> <span>CLV/PM</span> <span>EZOLV</span> </div> Sets the data log monitor. This parameter is only available on an LCD keypad.	107 (000,101 - 855)

**Note:**

Set the log data with values 101 to 999 [U1-01 to U9-99].

For example, to show U1-05 [Motor Speed], set o5-03 = 105. When it is not necessary to set data log monitors, set this parameter to 000. You cannot set U2 monitors [Fault Trace] or U3 Monitors [Fault History].

### ■ o5-07: Log Monitor Data 5

No. (Hex.)	Name	Description	Default (Range)
o5-07 (1557) RUN	Log Monitor Data 5	<div style="display: flex; justify-content: space-between; font-size: 0.8em; font-weight: bold; margin-bottom: 5px;"> <span>V/f</span> <span>CL-V/f</span> <span>OLV</span> <span>CLV</span> <span>AOLV</span> <span>OLV/PM</span> <span>AOLV/PM</span> <span>CLV/PM</span> <span>EZOLV</span> </div> Sets the data log monitor. This parameter is only available on an LCD keypad.	108 (000,101 - 855)

**Note:**

Set the log data with values 101 to 999 [U1-01 to U9-99].

For example, to show U1-05 [Motor Speed], set o5-07 = 105. When it is not necessary to set data log monitors, set this parameter to 000. You cannot set U2 monitors [Fault Trace] or U3 Monitors [Fault History].

### ■ o5-08: Log Monitor Data 6

No. (Hex.)	Name	Description	Default (Range)
o5-08 (1558) RUN	Log Monitor Data 6	<div style="display: flex; justify-content: space-between; font-size: 0.8em; font-weight: bold; margin-bottom: 5px;"> <span>V/f</span> <span>CL-V/f</span> <span>OLV</span> <span>CLV</span> <span>AOLV</span> <span>OLV/PM</span> <span>AOLV/PM</span> <span>CLV/PM</span> <span>EZOLV</span> </div> Sets the data log monitor. This parameter is only available on an LCD keypad.	000 (000,101 - 855)

**Note:**

Set the log data with values 101 to 999 [U1-01 to U9-99]. For example, to show U1-05 [Motor Speed], set o5-08 = 105. When it is not necessary to set data log monitors, set this parameter to 000. You cannot set U2 monitors [Fault Trace] or U3 Monitors [Fault History].

### ■ o5-09: Log Monitor Data 7

No. (Hex.)	Name	Description	Default (Range)
o5-09 (1559) RUN	Log Monitor Data 7	<div style="display: flex; justify-content: space-between; font-size: 0.8em; font-weight: bold; margin-bottom: 5px;"> <span>V/f</span> <span>CL-V/f</span> <span>OLV</span> <span>CLV</span> <span>AOLV</span> <span>OLV/PM</span> <span>AOLV/PM</span> <span>CLV/PM</span> <span>EZOLV</span> </div> Sets the data log monitor. This parameter is only available on an LCD keypad.	000 (000,101 - 855)

**Note:**

Set the log data with values 101 to 999 [U1-01 to U9-99].

For example, to show U1-05 [Motor Speed], set o5-09 = 105. When it is not necessary to set data log monitors, set this parameter to 000. You cannot set U2 monitors [Fault Trace] or U3 Monitors [Fault History].

### ■ o5-10: Log Monitor Data 8

No. (Hex.)	Name	Description	Default (Range)
o5-10 (155A) RUN	Log Monitor Data 8	<div style="display: flex; justify-content: space-between; font-size: 0.8em; font-weight: bold; margin-bottom: 5px;"> <span>V/f</span> <span>CL-V/f</span> <span>OLV</span> <span>CLV</span> <span>AOLV</span> <span>OLV/PM</span> <span>AOLV/PM</span> <span>CLV/PM</span> <span>EZOLV</span> </div> Sets the data log monitor. This parameter is only available on an LCD keypad.	000 (000,101 - 855)

**Note:**

Set the log data with values 101 to 999 [U1-01 to U9-99].

For example, to show U1-05 [Motor Speed], set o5-10 = 105. When it is not necessary to set data log monitors, set this parameter to 000. You cannot set U2 monitors [Fault Trace] or U3 Monitors [Fault History].

### ■ o5-11: Log Monitor Data 9

No. (Hex.)	Name	Description	Default (Range)
o5-11 (155B) RUN	Log Monitor Data 9	<div style="display: flex; justify-content: space-between; font-size: 0.8em; font-weight: bold; margin-bottom: 5px;"> <span>V/f</span> <span>CL-V/f</span> <span>OLV</span> <span>CLV</span> <span>AOLV</span> <span>OLV/PM</span> <span>AOLV/PM</span> <span>CLV/PM</span> <span>EZOLV</span> </div> Sets the data log monitor. This parameter is only available on an LCD keypad.	000 (000,101 - 855)

**Note:**

Set the log data with values 101 to 999 [U1-01 to U9-99].

For example, to show U1-05 [Motor Speed], set o5-11 = 105. When it is not necessary to set data log monitors, set this parameter to 000. You cannot set U2 monitors [Fault Trace] or U3 Monitors [Fault History].

### ■ o5-12: Log Monitor Data 10

No. (Hex.)	Name	Description	Default (Range)
o5-12 (155C) RUN	Log Monitor Data 10	<div style="display: flex; justify-content: space-between; font-size: 0.8em; font-weight: bold; margin-bottom: 5px;"> <span>V/f</span> <span>CL-V/f</span> <span>OLV</span> <span>CLV</span> <span>AOLV</span> <span>OLV/PM</span> <span>AOLV/PM</span> <span>CLV/PM</span> <span>EZOLV</span> </div> Sets the data log monitor. This parameter is only available on an LCD keypad.	000 (000,101 - 855)

**Note:**

Set the log data with values 101 to 999 [U1-01 to U9-99].

For example, to show U1-05 [Motor Speed], set o5-12 = 105. When it is not necessary to set data log monitors, set this parameter to 000. You cannot set U2 monitors [Fault Trace] or U3 Monitors [Fault History].

## 11.12 T: Auto-Tuning

Numbers identifying the *T* parameters are displayed when an LED keypad is used. The names of the parameters are displayed on the LCD screen of the LCD keypad. Set the following.

- Induction Motor Auto-Tuning
- PM Motor Auto-Tuning
- ASR and Inertia Tuning

### ◆ T0: Tuning Mode Selection

#### ■ T0-00: Tuning Mode Selection

When your control method supports Control Tuning, set *T0-00* first. Then, set *T1-00* [*Motor 1/Motor 2 Selection*] to select the motor you will tune. Then, set the tuning mode in *T2-01* [*PM Auto-Tuning Selection*] or *T3-00* [*Control Loop Tuning Selection*].

No. (Hex.)	Name	Description	Default (Range)
T0-00 (1197)	Tuning Mode Selection	<div style="display: flex; justify-content: space-between; font-size: 0.8em; font-weight: bold;"> <span>V/f</span> <span>CL-V/f</span> <span>OLV</span> <span>CLV</span> <span>AOLV</span> <span>OLV/PM</span> <span>AOLV/PM</span> <span>CLV/PM</span> <span>EZOLV</span> </div> Sets the type of Auto-Tuning.	0 (0, 1)

### 0 : Motor Parameter Tuning

#### 1 : Control Tuning

**Note:**

The available tuning modes are different for different control methods.

### ◆ T1: InductionMotor Auto-Tuning

*T1* parameters set the Auto-Tuning input data for induction motor tuning.

**Note:**

- The base frequency of drive dedicated motors and special motors for use with vector control may be lower than the base frequency of general-purpose motors, which is 50 Hz or 60 Hz. In such cases, this lower frequency is used as the value for *E1-06* [*Base Frequency*] and *E1-04* [*Maximum Output Frequency*] after Auto-Tuning completes. If the maximum output frequency is too low and causes problems, change the setting of *E1-04* after Auto-Tuning completes.
- The following induction motor parameters are set automatically.
  - E1-xx* [*V/f Pattern for Motor 1*]
  - E2-xx* [*Motor Parameters*]
  - E3-xx* [*V/f Pattern for Motor 2*]
  - E4-xx* [*Motor 2 Parameters*]
  - F1-xx* [*Encoder Options*] (only with Closed Loop Vector Control)

#### ■ T1-00: Motor 1/Motor 2 Selection

No. (Hex.)	Name	Description	Default (Range)
T1-00 (0700)	Motor 1/Motor 2 Selection	<div style="display: flex; justify-content: space-between; font-size: 0.8em; font-weight: bold;"> <span>V/f</span> <span>CL-V/f</span> <span>OLV</span> <span>CLV</span> <span>AOLV</span> <span>OLV/PM</span> <span>AOLV/PM</span> <span>CLV/PM</span> <span>EZOLV</span> </div> Sets which motor to tune when motor 1/2 switching is enabled. You can only use the keypad to set this parameter. You cannot use external input terminals to set it.	1 (1, 2)

**Note:**

Set *H1-xx = 16* [*Motor 2 Selection*] ON to set this parameter. The keypad will not show this parameter when *H1-xx = 16* is OFF.

#### 1 : Motor 1 (sets E1-00, E2-00)

Auto-Tuning automatically sets parameters *E1-xx* and *E2-xx* for motor 1.

#### 2 : Motor 2 (sets E3-00, E4-00)

Auto-Tuning automatically sets parameters *E3-xx* and *E4-xx* for motor 2. Make sure that you connect motor 2 to the drive for Auto-Tuning.



### ■ T1-01: Auto-Tuning Mode Selection

No. (Hex.)	Name	Description	Default (Range)
T1-01 (0701)	Auto-Tuning Mode Selection	<input checked="" type="checkbox"/> V/f <input checked="" type="checkbox"/> CL-V/f <input type="checkbox"/> OLV <input type="checkbox"/> CLV <input type="checkbox"/> AOLV <input type="checkbox"/> OLV/PM <input type="checkbox"/> AOLV/PM <input type="checkbox"/> CLV/PM <input type="checkbox"/> EZOLV Sets the type of Auto-Tuning.	Determined by A1-02 (Determined by A1-02)

0 : Rotational Auto-Tuning

1 : Stationary Auto-Tuning 1

2 : Stationary Line-Line Resistance

### ■ T1-02: Motor Rated Power

No. (Hex.)	Name	Description	Default (Range)
T1-02 (0702)	Motor Rated Power	<input checked="" type="checkbox"/> V/f <input checked="" type="checkbox"/> CL-V/f <input type="checkbox"/> OLV <input type="checkbox"/> CLV <input type="checkbox"/> AOLV <input type="checkbox"/> OLV/PM <input type="checkbox"/> AOLV/PM <input type="checkbox"/> CLV/PM <input type="checkbox"/> EZOLV Sets the rated output power (kW) of the motor.	Determined by o2-04 and C6-01 (0.00 - 650.00 kW)

Note:

Capacities 300 kW and smaller are set in units of 0.01 kW. Capacities larger than 300 kW are set in units of 0.1 kW. The maximum applicable motor output changes when the setting of C6-01 [Normal / Heavy Duty Selection] changes.

### ■ T1-03: Motor Rated Voltage

No. (Hex.)	Name	Description	Default (Range)
T1-03 (0703)	Motor Rated Voltage	<input checked="" type="checkbox"/> V/f <input checked="" type="checkbox"/> CL-V/f <input type="checkbox"/> OLV <input type="checkbox"/> CLV <input type="checkbox"/> AOLV <input type="checkbox"/> OLV/PM <input type="checkbox"/> AOLV/PM <input type="checkbox"/> CLV/PM <input type="checkbox"/> EZOLV Sets the rated voltage (V) of the motor. Enter the base speed voltage for constant output motors.	Determined by o2-04 and C6-01 (200 V Class: 0.0 - 255.5 V, 400 V Class: 0.0 - 511.0 V)

If you do Auto-Tuning on a drive-dedicated motor or a specialized motor for vector control, the voltage or frequency can be lower than that of a general-purpose motor. Always compare the data from the nameplate or test report with the Auto-Tuning results and check for differences. Enter the voltage necessary to operate the motor in no-load conditions at rated speed for better control precision around rated speed. If the motor test report or the motor nameplate is not available, enter approximately 90% of the motor rated voltage.

If the drive input power supply voltage is low, enter approximately 90% of the input voltage. When the input power supply voltage is low, the current will increase. Make sure that the main power supply capacity is correct and use a molded-case circuit breaker for the drive.

### ■ T1-04: Motor Rated Current

No. (Hex.)	Name	Description	Default (Range)
T1-04 (0704)	Motor Rated Current	<input checked="" type="checkbox"/> V/f <input checked="" type="checkbox"/> CL-V/f <input type="checkbox"/> OLV <input type="checkbox"/> CLV <input type="checkbox"/> AOLV <input type="checkbox"/> OLV/PM <input type="checkbox"/> AOLV/PM <input type="checkbox"/> CLV/PM <input type="checkbox"/> EZOLV Sets the rated current (A) of the motor.	Determined by o2-04 (10% to 200% of the drive rated current)

Set the motor rated current between 50% and 100% of the drive rated current for the best performance. Enter the current at the motor base speed.

### ■ T1-05: Motor Base Frequency

No. (Hex.)	Name	Description	Default (Range)
T1-05 (0705)	Motor Base Frequency	<input checked="" type="checkbox"/> V/f <input checked="" type="checkbox"/> CL-V/f <input type="checkbox"/> OLV <input type="checkbox"/> CLV <input type="checkbox"/> AOLV <input type="checkbox"/> OLV/PM <input type="checkbox"/> AOLV/PM <input type="checkbox"/> CLV/PM <input type="checkbox"/> EZOLV Sets the base frequency (Hz) of the motor.	50.0 Hz (0.0 - 590.0 Hz)

Auto-Tuning sets T1-05 = E1-04 [Maximum Output Frequency]. If T1-05 < 40 Hz, E1-04 = 40 Hz. If you operate the drive at a speed that is higher than the base frequency, or if you operate in the field weakening range, set E1-04 (E3-04 for motor 2) to the maximum output frequency after you complete Auto-Tuning.

### ■ T1-06: Number of Motor Poles

No. (Hex.)	Name	Description	Default (Range)
T1-06 (0706)	Number of Motor Poles	<input type="checkbox"/> V/f <input type="checkbox"/> CL-V/f <input type="checkbox"/> OLV <input checked="" type="checkbox"/> CLV <input type="checkbox"/> AOLV <input type="checkbox"/> OLV/PM <input type="checkbox"/> AOLV/PM <input type="checkbox"/> CLV/PM <input type="checkbox"/> EZOLV Sets the number of motor poles.	4 (2 - 48)

### ■ T1-07: Motor Base Speed

No. (Hex.)	Name	Description	Default (Range)
T1-07 (0707)	Motor Base Speed	<input type="checkbox"/> V/f <input type="checkbox"/> CL-V/f <input type="checkbox"/> OLV <input checked="" type="checkbox"/> CLV <input type="checkbox"/> AOLV <input type="checkbox"/> OLV/PM <input type="checkbox"/> AOLV/PM <input type="checkbox"/> CLV/PM <input type="checkbox"/> EZOLV Sets the motor base speed for Auto-Tuning (min <sup>-1</sup> (r/min)).	1450 min <sup>-1</sup> (r/min) (0 - 35400 min <sup>-1</sup> (r/min))

### ■ T1-08: Encoder Pulse Count (PPR)

No. (Hex.)	Name	Description	Default (Range)
T1-08 (0708)	Encoder Pulse Count (PPR)	<input type="checkbox"/> V/f <input type="checkbox"/> CL-V/f <input type="checkbox"/> OLV <input checked="" type="checkbox"/> CLV <input type="checkbox"/> AOLV <input type="checkbox"/> OLV/PM <input type="checkbox"/> AOLV/PM <input type="checkbox"/> CLV/PM <input type="checkbox"/> EZOLV Sets the number of PG (pulse generator, encoder) pulses.	1024 ppr (0 - 60,000 ppr)

Set the actual number of pulses for one full motor rotation.

### ■ T1-09: Motor No-Load Current

No. (Hex.)	Name	Description	Default (Range)
T1-09 (0709)	Motor No-Load Current	<input type="checkbox"/> V/f <input type="checkbox"/> CL-V/f <input checked="" type="checkbox"/> OLV <input checked="" type="checkbox"/> CLV <input type="checkbox"/> AOLV <input type="checkbox"/> OLV/PM <input type="checkbox"/> AOLV/PM <input type="checkbox"/> CLV/PM <input type="checkbox"/> EZOLV Sets the no-load current of the motor.	- (0A - T1-04; max. of 2999.9)

**Note:**

The display units are different for different models:

- 2004 to 2042, 4002 to 4023: 0.01 A
- 2056 to 2415, 4031 to 4675: 0.1 A

The value shown is the no-load current that is automatically calculated from the values set in *T1-02 [Motor Rated Power]* and *T1-04 [Motor Rated Current]*. Set the no-load current shown on the motor test report. If the motor test report is not available, do not change this parameter.

### ■ T1-10: Motor Rated Slip Frequency

No. (Hex.)	Name	Description	Default (Range)
T1-10 (070A)	Motor Rated Slip Frequency	<input type="checkbox"/> V/f <input type="checkbox"/> CL-V/f <input checked="" type="checkbox"/> OLV <input checked="" type="checkbox"/> CLV <input type="checkbox"/> AOLV <input type="checkbox"/> OLV/PM <input type="checkbox"/> AOLV/PM <input type="checkbox"/> CLV/PM <input type="checkbox"/> EZOLV Sets the motor rated slip.	- (0.000 - 20.000 Hz)

Shows 0.000 Hz as the default value. Set the rated slip shown on the motor test report. If the motor test report is not available, do not change this parameter.

### ■ T1-11: Motor Iron Loss

No. (Hex.)	Name	Description	Default (Range)
T1-11 (070B)	Motor Iron Loss	<input type="checkbox"/> V/f <input checked="" type="checkbox"/> CL-V/f <input type="checkbox"/> OLV <input type="checkbox"/> CLV <input type="checkbox"/> AOLV <input type="checkbox"/> OLV/PM <input type="checkbox"/> AOLV/PM <input type="checkbox"/> CLV/PM <input type="checkbox"/> EZOLV Sets the iron loss for calculating the energy-saving coefficient.	Determined by E2-11 or E4-11 (0 - 65535 W)

**Note:**

The default setting is different for different motor codes and motor parameter settings.

The value shown is the *E2-10 [Motor Iron Loss]* or *E4-10 [Motor 2 Iron Loss]* for the motor output set in *T1-02 [Motor Rated Power]*. If the motor test report is available, enter the motor iron loss value to *T1-11*.

## ■ T1-12: Test Mode Selection

No. (Hex.)	Name	Description	Default (Range)
T1-12 (0BDB)	Test Mode Selection	<div style="display: flex; justify-content: space-between; font-size: 0.8em; margin-bottom: 5px;"> <span>V/f</span> <span>CL-V/f</span> <span>OLV</span> <span>CLV</span> <span>AOLV</span> <span>OLV/PM</span> <span>AOLV/PM</span> <span>CLV/PM</span> <span>EZOLV</span> </div> Sets the function to enable Test Mode after Stationary Auto-Tuning. When you can operate the motor with a light load attached after Stationary Auto-Tuning is complete, enable this parameter.	0 (0, 1)

**0 : No**

**1 : Yes**

After Auto-Tuning, the drive automatically sets *E2-02 [Motor Rated Slip]* and *E2-03 [Motor No-Load Current]* when you operate the motor for the first time in Drive Mode.

**Note:**

After Auto-Tuning is complete and you set the drive to Drive Mode, operate the motor in these conditions:

- Make sure that you connect all wiring between the drive and motor
- Make sure that a mechanical brake on the motor shaft is not locked
- Keep the motor-load ratio at 30%
- Hold constant speed for longer than 1 second at a minimum of 30% of the speed set in *E1-06 [Base Frequency]* (the default setting is the same as the maximum frequency).

## ■ T1-13: No-load voltage

No. (Hex.)	Name	Description	Default (Range)
T1-13 (0BDC)	No-load voltage	<div style="display: flex; justify-content: space-between; font-size: 0.8em; margin-bottom: 5px;"> <span>V/f</span> <span>CL-V/f</span> <span>OLV</span> <span>CLV</span> <span>AOLV</span> <span>OLV/PM</span> <span>AOLV/PM</span> <span>CLV/PM</span> <span>EZOLV</span> </div> Sets the no-load voltage of the motor. If no-load voltage is necessary at rated speed for the motor test report, set the voltage in this parameter. If the motor test report is not available, do not change this parameter.	90% of T1-03 (200 V Class: 0.0 - 255.0 V, 400 V Class: 0.0 - 510.0 V)

**Note:**

To get the same qualities as a Yaskawa 1000-series drive or previous models, set this parameter = *T1-03 [Motor Rated Voltage]* value.

## ◆ T2: PM Motor Auto-Tuning

*T2 parameters* set the Auto-Tuning input data for PM motor tuning.

**Note:**

The drive automatically sets these PM motor parameters:

- E1-xx [V/f Pattern for Motor 1]
- E5-xx [PM Motor Settings]
- F1-xx [PG Speed Control Card (Encoder)] (CLV only)

## ■ T2-01: PM Auto-Tuning Selection

No. (Hex.)	Name	Description	Default (Range)
T2-01 (0750)	PM Auto-Tuning Selection	<div style="display: flex; justify-content: space-between; font-size: 0.8em; margin-bottom: 5px;"> <span>V/f</span> <span>CL-V/f</span> <span>OLV</span> <span>CLV</span> <span>AOLV</span> <span>OLV/PM</span> <span>AOLV/PM</span> <span>CLV/PM</span> <span>EZOLV</span> </div> Sets the type of Auto-Tuning for PM motors.	0 (Determined by A1-02)

**Note:**

Yaskawa recommends Rotational (Ld, Lq, R, back-EMF) for specialized motors. Rotational Auto-Tuning rotates the motor to measure the actual induction voltage constants for more accurate control than Stationary Auto-Tuning.

**0 : Manual Entry w/ Motor Data Sheet**

**1 : Stationary (Ld, Lq, R)**

**2 : Stationary (R Only)**

**3 : Z-Pulse Offset (Pole Position)**

**4 : Rotational (Ld, Lq, R, back-EMF)**

### ■ T2-02: PM Motor Code Selection

No. (Hex.)	Name	Description	Default (Range)
T2-02 (0751)	PM Motor Code Selection	<div style="display: flex; justify-content: space-between; font-size: 0.8em; margin-bottom: 5px;"> <span>V/f</span> <span>CL-V/f</span> <span>OLV</span> <span>CLV</span> <span>AOLV</span> <span style="background-color: #cccccc;">OLV/PM</span> <span style="background-color: #cccccc;">AOLV/PM</span> <span style="background-color: #cccccc;">CLV/PM</span> <span>EZOLV</span> </div> Sets the PM motor code for drives operating SMRA, SSR1, or SST4-series Yaskawa PM motors.	Determined by A1-02 and o2-04 (0000 - FFFF)

Enter the motor code in *T2-02* to automatically set parameters *T2-03* to *T2-14*. When you are operating a specialized motor or a non-Yaskawa motor designed, set *T2-02* = *FFFF* and enter the data from the motor nameplate or the motor test report.

You can only enter the permitted PM motor codes. Different drive control methods will accept different PM motor codes.

### ■ T2-03: PM Motor Type

No. (Hex.)	Name	Description	Default (Range)
T2-03 (0752)	PM Motor Type	<div style="display: flex; justify-content: space-between; font-size: 0.8em; margin-bottom: 5px;"> <span>V/f</span> <span>CL-V/f</span> <span>OLV</span> <span>CLV</span> <span>AOLV</span> <span style="background-color: #cccccc;">OLV/PM</span> <span style="background-color: #cccccc;">AOLV/PM</span> <span style="background-color: #cccccc;">CLV/PM</span> <span>EZOLV</span> </div> Sets the type of PM motor the drive will operate.	1 (0, 1)

0 : IPM motor

1 : SPM motor

### ■ T2-04: PM Motor Rated Power

No. (Hex.)	Name	Description	Default (Range)
T2-04 (0730)	PM Motor Rated Power	<div style="display: flex; justify-content: space-between; font-size: 0.8em; margin-bottom: 5px;"> <span>V/f</span> <span>CL-V/f</span> <span>OLV</span> <span>CLV</span> <span>AOLV</span> <span style="background-color: #cccccc;">OLV/PM</span> <span style="background-color: #cccccc;">AOLV/PM</span> <span style="background-color: #cccccc;">CLV/PM</span> <span>EZOLV</span> </div> Sets the rated output power (kW) of a PM motor.	Determined by o2-04 and C6-01 (0.00 - 650.00 kW)

**Note:**

Capacities 300 kW and less are set in units of 0.01 kW. Capacities above 300 kW are set in units of 0.1 kW. The maximum applicable motor output varies depending on the setting of *C6-01* [*Normal / Heavy Duty Selection*].

### ■ T2-05: PM Motor Rated Voltage

No. (Hex.)	Name	Description	Default (Range)
T2-05 (0732)	PM Motor Rated Voltage	<div style="display: flex; justify-content: space-between; font-size: 0.8em; margin-bottom: 5px;"> <span>V/f</span> <span>CL-V/f</span> <span>OLV</span> <span>CLV</span> <span>AOLV</span> <span style="background-color: #cccccc;">OLV/PM</span> <span style="background-color: #cccccc;">AOLV/PM</span> <span style="background-color: #cccccc;">CLV/PM</span> <span>EZOLV</span> </div> Sets the rated voltage (V) of the motor.	200 V Class: 200.0 V, 400 V Class: 400.0 V (200 V Class: 0.0 - 255.0 V, 400 V Class: 0.0 - 510.0 V)

### ■ T2-06: PM Motor Rated Current

No. (Hex.)	Name	Description	Default (Range)
T2-06 (0733)	PM Motor Rated Current	<div style="display: flex; justify-content: space-between; font-size: 0.8em; margin-bottom: 5px;"> <span>V/f</span> <span>CL-V/f</span> <span>OLV</span> <span>CLV</span> <span>AOLV</span> <span style="background-color: #cccccc;">OLV/PM</span> <span style="background-color: #cccccc;">AOLV/PM</span> <span style="background-color: #cccccc;">CLV/PM</span> <span>EZOLV</span> </div> Sets the rated current (A) of the motor.	Determined by o2-04 (10% to 200% of the drive rated current)

### ■ T2-07: PM Motor Base Frequency

No. (Hex.)	Name	Description	Default (Range)
T2-07 (0753)	PM Motor Base Frequency	<div style="display: flex; justify-content: space-between; font-size: 0.8em; margin-bottom: 5px;"> <span>V/f</span> <span>CL-V/f</span> <span>OLV</span> <span>CLV</span> <span>AOLV</span> <span style="background-color: #cccccc;">OLV/PM</span> <span style="background-color: #cccccc;">AOLV/PM</span> <span style="background-color: #cccccc;">CLV/PM</span> <span>EZOLV</span> </div> Sets the base frequency (Hz) of the motor.	87.5 Hz (0.0 - 590.0 Hz)

### ■ T2-08: Number of PM Motor Poles

No. (Hex.)	Name	Description	Default (Range)
T2-08 (0734)	Number of PM Motor Poles	<input type="checkbox"/> V/f <input type="checkbox"/> CL-V/f <input type="checkbox"/> OLV <input type="checkbox"/> CLV <input type="checkbox"/> AOLV <input checked="" type="checkbox"/> OLV/PM <input checked="" type="checkbox"/> AOLV/PM <input checked="" type="checkbox"/> CLV/PM <input type="checkbox"/> EZOLV Sets the number of motor poles.	6 (2 - 48)

### ■ T2-09: PM Motor Base Speed

No. (Hex.)	Name	Description	Default (Range)
T2-09 (0731)	PM Motor Base Speed	<input type="checkbox"/> V/f <input type="checkbox"/> CL-V/f <input type="checkbox"/> OLV <input type="checkbox"/> CLV <input type="checkbox"/> AOLV <input checked="" type="checkbox"/> OLV/PM <input checked="" type="checkbox"/> AOLV/PM <input checked="" type="checkbox"/> CLV/PM <input type="checkbox"/> EZOLV Sets the motor base speed (min <sup>-1</sup> (r/min)).	1750 min <sup>-1</sup> (r/min) (0 - 34500 min <sup>-1</sup> (r/min))

### ■ T2-10: PM Motor Stator Resistance

No. (Hex.)	Name	Description	Default (Range)
T2-10 (0754)	PM Motor Stator Resistance	<input type="checkbox"/> V/f <input type="checkbox"/> CL-V/f <input type="checkbox"/> OLV <input type="checkbox"/> CLV <input type="checkbox"/> AOLV <input checked="" type="checkbox"/> OLV/PM <input checked="" type="checkbox"/> AOLV/PM <input checked="" type="checkbox"/> CLV/PM <input type="checkbox"/> EZOLV Sets the stator resistance for each motor phase.	Determined by T2-02 (0.000 - 65.000 Ω)

**Note:**

This parameter does not set line-to-line resistance.

### ■ T2-11: PM Motor d-Axis Inductance

No. (Hex.)	Name	Description	Default (Range)
T2-11 (0735)	PM Motor d-Axis Inductance	<input type="checkbox"/> V/f <input type="checkbox"/> CL-V/f <input type="checkbox"/> OLV <input type="checkbox"/> CLV <input type="checkbox"/> AOLV <input checked="" type="checkbox"/> OLV/PM <input checked="" type="checkbox"/> AOLV/PM <input checked="" type="checkbox"/> CLV/PM <input type="checkbox"/> EZOLV Sets the d-axis inductance of the motor on a per phase basis.	Determined by T2-02 (0.00 - 600.00 mH)

### ■ T2-12: PM Motor q-Axis Inductance

No. (Hex.)	Name	Description	Default (Range)
T2-12 (0736)	PM Motor q-Axis Inductance	<input type="checkbox"/> V/f <input type="checkbox"/> CL-V/f <input type="checkbox"/> OLV <input type="checkbox"/> CLV <input type="checkbox"/> AOLV <input checked="" type="checkbox"/> OLV/PM <input checked="" type="checkbox"/> AOLV/PM <input checked="" type="checkbox"/> CLV/PM <input type="checkbox"/> EZOLV Sets the q-Axis inductance of the motor on a per phase basis.	Determined by T2-02 (0.00 - 600.00 mH)

### ■ T2-13: Back-EMF Units Selection

No. (Hex.)	Name	Description	Default (Range)
T2-13 (0755)	Back-EMF Units Selection	<input type="checkbox"/> V/f <input type="checkbox"/> CL-V/f <input type="checkbox"/> OLV <input type="checkbox"/> CLV <input type="checkbox"/> AOLV <input checked="" type="checkbox"/> OLV/PM <input checked="" type="checkbox"/> AOLV/PM <input checked="" type="checkbox"/> CLV/PM <input type="checkbox"/> EZOLV Sets the units that the drive uses to set the induced voltage constant.	1 (0, 1)

0 : mV/(rev/min)

1 : mV/(rad/s)

**Note:**

- When T2-13 = 0, the drive will use E5-24 [PM Back-EMF L-L Vrms (mV/rpm)] and will automatically set E5-09 [PM Back-EMF Vpeak (mV/(rad/s))] = 0.0.
- When T2-13 = 1, the drive will use E5-09 and will automatically set E5-24 = 0.0.

### ■ T2-14: Back-EMF Voltage Constant (Ke)

No. (Hex.)	Name	Description	Default (Range)
T2-14 (0737)	Back-EMF Voltage Constant (Ke)	<input type="checkbox"/> V/f <input type="checkbox"/> CL-V/f <input type="checkbox"/> OLV <input type="checkbox"/> CLV <input type="checkbox"/> AOLV <input checked="" type="checkbox"/> OLV/PM <input checked="" type="checkbox"/> AOLV/PM <input checked="" type="checkbox"/> CLV/PM <input type="checkbox"/> EZOLV Sets the motor induced voltage constant (Ke).	Determined by T2-13 (0.0 - 2000.0)

### ■ T2-15: Pull-In Current Level

No. (Hex.)	Name	Description	Default (Range)
T2-15 (0756)	Pull-In Current Level	<div style="display: flex; justify-content: space-between; font-size: 0.8em; font-weight: normal;"> <span>V/f</span> <span>CL-V/f</span> <span>OLV</span> <span>CLV</span> <span>AOLV</span> <span style="background-color: #cccccc;">OLV/PM</span> <span style="background-color: #cccccc;">AOLV/PM</span> <span style="background-color: #cccccc;">CLV/PM</span> <span>EZOLV</span> </div> Sets the level of the pull-in current as a percentage, where 100% = motor rated current. Usually it is not necessary to change this setting.	30% (0 - 120%)

If the load inertia is high, increase the setting value.

### ■ T2-16: Encoder Pulse Count (PPR)

No. (Hex.)	Name	Description	Default (Range)
T2-16 (0738)	Encoder Pulse Count (PPR)	<div style="display: flex; justify-content: space-between; font-size: 0.8em; font-weight: normal;"> <span>V/f</span> <span>CL-V/f</span> <span>OLV</span> <span>CLV</span> <span>AOLV</span> <span>OLV/PM</span> <span>AOLV/PM</span> <span style="background-color: #cccccc;">CLV/PM</span> <span>EZOLV</span> </div> Sets the number of PG (pulse generator, encoder) pulses.	1024 ppr (1 - 15000 ppr)

Set the actual number of pulses for one full motor rotation.

### ■ T2-17: Encoder Z-Pulse Offset

No. (Hex.)	Name	Description	Default (Range)
T2-17 (0757)	Encoder Z-Pulse Offset	<div style="display: flex; justify-content: space-between; font-size: 0.8em; font-weight: normal;"> <span>V/f</span> <span>CL-V/f</span> <span>OLV</span> <span>CLV</span> <span>AOLV</span> <span>OLV/PM</span> <span>AOLV/PM</span> <span style="background-color: #cccccc;">CLV/PM</span> <span>EZOLV</span> </div> Sets the encoder Z-pulse offset ( $\Delta\theta$ ) (pulse generator, encoder) that is listed on the motor nameplate.	0.0° (-180.0 - +180.0°)

If you do not know the quantity of encoder (pulse generator, encoder) Z-pulse offset, or if you replaced the encoder, do Z Pulse Offset Tuning and correct for the offset ( $\Delta\theta$ ) from the Z phase.

## ◆ T3: ASR and Inertia Tuning

### ■ T3-00: Control Loop Tuning Selection

No. (Hex.)	Name	Description	Default (Range)
T3-00 (1198)	Control Loop Tuning Selection	<div style="display: flex; justify-content: space-between; font-size: 0.8em; font-weight: normal;"> <span>V/f</span> <span>CL-V/f</span> <span>OLV</span> <span>CLV</span> <span>AOLV</span> <span>OLV/PM</span> <span>AOLV/PM</span> <span>CLV/PM</span> <span style="background-color: #cccccc;">EZOLV</span> </div> Sets the type of Control Auto-Tuning.	0 (0 - 3)

0 : Inertia Tuning

1 : ASR (Speed Regulator)

2 : Deceleration Rate Tuning

3 : KEB Tuning

Note:

Settings 0 and 1 are available only when A1-02 = 3, 7 [Control Method Selection = Closed Loop Vector or PM Closed Loop Vector].

### ■ T3-01: Test Signal Frequency

No. (Hex.)	Name	Description	Default (Range)
T3-01 (0760)	Test Signal Frequency	<div style="display: flex; justify-content: space-between; font-size: 0.8em; font-weight: normal;"> <span>V/f</span> <span>CL-V/f</span> <span>OLV</span> <span style="background-color: #cccccc;">CLV</span> <span>AOLV</span> <span>OLV/PM</span> <span>AOLV/PM</span> <span>CLV/PM</span> <span>EZOLV</span> </div> Sets the frequency of the test signal applied to the motor during Inertia Tuning. Usually it is not necessary to change this setting.	3.0 Hz (0.1 - 20.0 Hz)

If the load inertia is too large and the drive detects a fault after Inertia Tuning, decrease the setting.

### ■ T3-02: Test Signal Amplitude

No. (Hex.)	Name	Description	Default (Range)
T3-02 (0761)	Test Signal Amplitude	<div style="display: flex; justify-content: space-between; font-size: 0.8em; font-weight: normal;"> <span>V/f</span> <span>CL-V/f</span> <span>OLV</span> <span style="background-color: #cccccc;">CLV</span> <span>AOLV</span> <span>OLV/PM</span> <span>AOLV/PM</span> <span>CLV/PM</span> <span>EZOLV</span> </div> Sets the amplitude of the test signal applied to the motor during Inertia Tuning. Usually it is not necessary to change this setting.	0.5 rad (0.1 - 10.0 rad)

If the load inertia is too large and the drive detects a fault after Inertia Tuning, decrease the setting. If the drive detects a fault when *T3-01 [Test Signal Frequency]* is set to a low value, adjust this parameter.

### ■ T3-03: Motor Inertia

No. (Hex.)	Name	Description	Default (Range)
T3-03 (0762)	Motor Inertia	<div style="display: flex; justify-content: space-between; font-size: 0.8em; margin-bottom: 5px;"> <span>V/f</span> <span>CL-V/f</span> <span>OLV</span> <span style="background-color: #cccccc;">CLV</span> <span>AOLV</span> <span>OLV/PM</span> <span>AOLV/PM</span> <span style="background-color: #cccccc;">CLV/PM</span> <span>EZOLV</span> </div> Sets the inertia of the motor. This value uses the test signal response to calculate the load inertia.	Determined by <i>o2-04</i> , <i>C6-01</i> , and <i>E5-01</i> (0.0001 - 6.0000 kgm <sup>2</sup> )

The default setting is for a Yaskawa standard motor as shown in the motor inertia table. Actual values will be different when you use induction motors or PM motors.

**Note:**

Capacities smaller than 37 kW are set in units of 0.0001 kgm<sup>2</sup>. Capacities 37 kW and larger are set in units of 0.001 kgm<sup>2</sup>.

### ■ T3-04: System Response Frequency

No. (Hex.)	Name	Description	Default (Range)
T3-04 (0763)	System Response Frequency	<div style="display: flex; justify-content: space-between; font-size: 0.8em; margin-bottom: 5px;"> <span>V/f</span> <span>CL-V/f</span> <span>OLV</span> <span style="background-color: #cccccc;">CLV</span> <span>AOLV</span> <span>OLV/PM</span> <span>AOLV/PM</span> <span style="background-color: #cccccc;">CLV/PM</span> <span>EZOLV</span> </div> This parameter uses the load inertia value from the Inertia Tuning process to automatically calculate and set <i>C5-01 [ASR Proportional Gain 1]</i> .	10.0 Hz (0.1 - 50.0 Hz)

If this input value is too high, it can cause oscillation.

## ◆ T4: EZ Tuning

Use *T4 parameters* to input the data necessary for motor parameter Auto-Tuning when *A1-02 = 8 [Control Method Selection = EZ Vector Control]*. These two modes are available:

Value set in T4-01	Operational overview	Items input for tuning	Items tuned
0	Follow the instructions in the setup wizard on the keypad to manually enter the necessary motor parameters.	<ul style="list-style-type: none"> <li>• T4-02 [Motor Type Selection]</li> <li>• T4-03 [Motor Max Revolutions]</li> <li>• T4-04 [Motor Rated Revolutions]</li> <li>• T4-05 [Motor Rated Frequency]</li> <li>• T4-06 [Motor Rated Voltage]</li> <li>• T4-07 [Motor Rated Current]</li> <li>• T4-08 [Motor Rated Capacity]</li> <li>• T4-09 [Number of Poles]</li> </ul>	<ul style="list-style-type: none"> <li>• E9-01 [Motor Type Selection]</li> <li>• E9-02 [Maximum Speed]</li> <li>• E9-03 [Rated Speed]</li> <li>• E9-04 [Base Frequency]</li> <li>• E9-05 [Base Voltage]</li> <li>• E9-06 [Motor Rated Current (FLA)]</li> <li>• E9-07 [Motor Rated Power (kW)]</li> <li>• E9-08 [Motor Pole Count]</li> <li>• E9-09 [Motor Rated Slip]</li> <li>• E9-10 [Motor Line-to-Line Resistance]</li> </ul>
1	Do only line-to-line resistance tuning.	Motor Rated Current (FLA)	E9-10 [Motor Line-to-Line Resistance]

\*1 When you use a PM motor or a synchronous reluctance motor, it is not necessary to use the setup wizard. The drive will use the rated rotation speed and number of motor poles to automatically calculate the rated frequency.

### ■ T4-01: EZ Tuning Mode Selection

No. (Hex.)	Name	Description	Default (Range)
T4-01 (3130)	EZ Tuning Mode Selection	<div style="display: flex; justify-content: space-between; font-size: 0.8em; margin-bottom: 5px;"> <span>V/f</span> <span>CL-V/f</span> <span>OLV</span> <span style="background-color: #cccccc;">CLV</span> <span>AOLV</span> <span>OLV/PM</span> <span>AOLV/PM</span> <span style="background-color: #cccccc;">CLV/PM</span> <span style="background-color: #cccccc;">EZOLV</span> </div> Sets the type of Auto-Tuning for EZOLV control.	0 (0, 1)

#### 0 : Motor Parameter Setting

#### 1 : Line-to-Line Resistance

### ■ T4-02: Motor Type Selection

No. (Hex.)	Name	Description	Default (Range)
T4-02 (3131)	Motor Type Selection	<input type="checkbox"/> V/f <input type="checkbox"/> CL-V/f <input type="checkbox"/> OLV <input type="checkbox"/> CLV <input type="checkbox"/> AOLV <input type="checkbox"/> OLV/PM <input type="checkbox"/> AOLV/PM <input type="checkbox"/> CLV/PM <input checked="" type="checkbox"/> EZOLV Sets the type of motor.	0 (0, 1, 2)

0 : Induction (IM)

1 : Permanent Magnet (PM)

2 : Synchronous Reluctance (SynRM)

### ■ T4-03: Motor Max Revolutions

No. (Hex.)	Name	Description	Default (Range)
T4-03 (3132)	Motor Max Revolutions	<input type="checkbox"/> V/f <input type="checkbox"/> CL-V/f <input type="checkbox"/> OLV <input type="checkbox"/> CLV <input type="checkbox"/> AOLV <input type="checkbox"/> OLV/PM <input type="checkbox"/> AOLV/PM <input type="checkbox"/> CLV/PM <input checked="" type="checkbox"/> EZOLV Sets the maximum motor revolutions (min <sup>-1</sup> ).	- ((40 to 120 Hz) × 60 × 2 / E9-08)

### ■ T4-04: Motor Rated Revolutions

No. (Hex.)	Name	Description	Default (Range)
T4-04 (3133)	Motor Rated Revolutions	<input type="checkbox"/> V/f <input type="checkbox"/> CL-V/f <input type="checkbox"/> OLV <input type="checkbox"/> CLV <input type="checkbox"/> AOLV <input type="checkbox"/> OLV/PM <input type="checkbox"/> AOLV/PM <input type="checkbox"/> CLV/PM <input checked="" type="checkbox"/> EZOLV Sets rated rotation speed (min <sup>-1</sup> ) of the motor.	- ((40 to 120 Hz) × 60 × 2 / E9-08)

### ■ T4-05: Motor Rated Frequency

No. (Hex.)	Name	Description	Default (Range)
T4-05 (3134)	Motor Rated Frequency	<input type="checkbox"/> V/f <input type="checkbox"/> CL-V/f <input type="checkbox"/> OLV <input type="checkbox"/> CLV <input type="checkbox"/> AOLV <input type="checkbox"/> OLV/PM <input type="checkbox"/> AOLV/PM <input type="checkbox"/> CLV/PM <input checked="" type="checkbox"/> EZOLV Sets the rated frequency (Hz) of the motor.	Determined by E9-01 and o2-04 (40.0 - 120.0 Hz)

**Note:**

When T4-02 = 1, 2 [Motor Type Selection = PM, SynRM], input is not necessary because it assumes: Motor Rated Revolutions/60 × Number of Motor Poles/2.

### ■ T4-06: Motor Rated Voltage

No. (Hex.)	Name	Description	Default (Range)
T4-06 (3135)	Motor Rated Voltage	<input type="checkbox"/> V/f <input type="checkbox"/> CL-V/f <input type="checkbox"/> OLV <input type="checkbox"/> CLV <input type="checkbox"/> AOLV <input type="checkbox"/> OLV/PM <input type="checkbox"/> AOLV/PM <input type="checkbox"/> CLV/PM <input checked="" type="checkbox"/> EZOLV Sets the rated voltage (V) of the motor.	200 V Class: 200.0 V, 400 V Class: 400.0 V (200 V Class: 0.0 - 255.0 V, 400 V Class: 0.0 - 510.0 V)

### ■ T4-07: Motor Rated Current

No. (Hex.)	Name	Description	Default (Range)
T4-07 (3136)	Motor Rated Current	<input type="checkbox"/> V/f <input type="checkbox"/> CL-V/f <input type="checkbox"/> OLV <input type="checkbox"/> CLV <input type="checkbox"/> AOLV <input type="checkbox"/> OLV/PM <input type="checkbox"/> AOLV/PM <input type="checkbox"/> CLV/PM <input checked="" type="checkbox"/> EZOLV Sets the rated current (A) of the motor.	Determined by o2-04 and C6-01 (10% to 200% of the drive rated current)

**Note:**

The value set here becomes the base value for motor protection, the torque limit, and torque control.



### ■ T4-08: Motor Rated Capacity

No. (Hex.)	Name	Description	Default (Range)
T4-08 (3137)	Motor Rated Capacity	<div style="display: flex; justify-content: space-between; font-size: 0.8em; margin-bottom: 5px;"> <span>V/f</span> <span>CL-V/f</span> <span>OLV</span> <span>CLV</span> <span>AOLV</span> <span>OLV/PM</span> <span>AOLV/PM</span> <span>CLV/PM</span> <span style="background-color: #333; color: white; padding: 2px;">EZOLV</span> </div> Sets the motor rated capacity in 0.01 kW units.	Determined by E9-10 (0.10 - 650.00 kW)

### ■ T4-09: Number of Poles

No. (Hex.)	Name	Description	Default (Range)
T4-09 (3138)	Number of Poles	<div style="display: flex; justify-content: space-between; font-size: 0.8em; margin-bottom: 5px;"> <span>V/f</span> <span>CL-V/f</span> <span>OLV</span> <span>CLV</span> <span>AOLV</span> <span>OLV/PM</span> <span>AOLV/PM</span> <span>CLV/PM</span> <span style="background-color: #333; color: white; padding: 2px;">EZOLV</span> </div> Sets the number of motor poles.	Determined by E9-01 (2 - 48)

# Index

## Symbols

## Numerics

- 24 V power supply
  - Power supply input terminals ..... 108

## A

- AC reactor
  - Wiring ..... 125
- Acceleration and deceleration times
  - Switching by external input ..... 749
  - Switching by output frequency ..... 750
  - switching by Motor 2 Selection commands ..... 750
- Acceleration time
  - Parameter ..... 749
  - Unit of measurement setting ..... 752
- Adjustment of control functionality ..... 204
- AER ..... 361
- AFR
  - Parameter ..... 989
- Alarm ..... 330, 361
- ALM indicator ..... 141, 144
- ALM/ERR
  - LED status ..... 147
- Altitude
  - Derating ..... 464
  - Environment ..... 35
- Ambient humidity ..... 35
- Ambient Temperature Setting
  - Parameter ..... 980
- Analog gauge
  - Monitors ..... 160
- Analog input
  - Function selection for terminals A1 through A3 ..... 911
- Analog Output
  - Gain/Bias Adjustment ..... 924
  - Monitor Parameter Selection ..... 924
  - Signal Level Selection ..... 924
  - Terminal AM Monitor Selection ..... 925
  - Terminal FM Monitor Selection ..... 925
- Application Preset ..... 679
  - Operation ..... 190
- ASR
  - Closed Loop V/f Control adjustment procedure ..... 762
  - Fine tuning ..... 764
  - Parameter ..... 762
  - Vector Control Adjustment Procedure ..... 763
- ASR tuning ..... 197
  - Precautions ..... 201
- Auto-Tuning ..... 192
  - ASR and Inertia Tuning Parameters ..... 1038
  - ASR tuning ..... 197
  - Induction motor ..... 192
  - Induction Motor Parameters ..... 1032
  - Inertia Tuning ..... 197
  - Operation ..... 176
  - PM motor ..... 193
  - PM Motor Parameters ..... 1035
  - Precautions ..... 199
  - Precautions to Note before ASR Tuning ..... 201
  - Precautions to Note before Inertia Tuning ..... 201
  - Rotational Auto-Tuning Precautions ..... 200
  - Stationary Auto-Tuning for Line-to-Line Resistance
    - precautions ..... 201
  - Stationary Auto-Tuning Precautions ..... 200

- Stator resistance Auto-Tuning precautions ..... 201
- Auto-Tuning Error ..... 330, 381

## B

- Backlight
  - Timing of shut-off ..... 186
- Backup
  - Parameters (drive to keypad) ..... 169
- Backup function ..... 1021
- Bar graph
  - Monitors ..... 158
- Base frequency
  - Parameter ..... 805
- Base Frequency
  - Motor 2 Parameters ..... 810
- Base voltage
  - Motor 2 parameters ..... 811
  - Parameter ..... 806
- Basic operation
  - Get started ..... 149
- bAT
  - Fault ..... 337
  - Minor Fault ..... 361
- Battery
  - Disposal ..... 441
  - Replacement ..... 437
  - Specifications ..... 437
- bb ..... 361
- bCE
  - Fault ..... 337
  - Minor Fault ..... 361
- Bi-Directional function ..... 788
- boL
  - Fault ..... 337
  - Minor Fault ..... 361
- Braking Resistor
  - Protective function ..... 978
  - Wiring ..... 119
- bUS
  - Detection condition settings ..... 848
  - Detection conditions ..... 842
  - Fault ..... 337
  - Minor Fault ..... 361
  - Operation Selection after Detection ..... 841

## C

- CALL ..... 362
- Capacitor Maintenance Setting ..... 1024
- Carrier frequency
  - Parameter ..... 771
- Carrier Frequency
  - Derating ..... 460
  - Diminish ..... 983
- CDBR type braking unit
  - Connect multiple units ..... 120
  - Wiring ..... 120
- CE
  - Detection Selection ..... 928
  - Detection Time ..... 929
  - Fault ..... 338
  - Minor Fault ..... 362
  - Operation Selection after Detection ..... 928
- CF ..... 338
- Checklist
  - Test run ..... 215
- Circulation Fan
  - Replacement ..... 405
- CoF ..... 339

Communication option			
Parameter	839	Detection time	823
Control Circuit Terminal Block		Fault	340
Replacement	431	Minor Fault	363
Control circuit terminals		Operation Selection after Detection	822
Configuration of terminal block	108	dFPS	386
I/O terminals function selection switches	112	DI-A3	
Terminal functions	105	Parameter	829
Wire gauge	109	Diagnosing and Resetting Faults	388
Wiring	104	Digital input option	
Wiring procedure for terminal block	110	Parameter	829
Control method		Digital output option	
Selection	676	Parameter	836
Cooling Fan		DIP switch	112
Activation Conditions Setting	980	Disposal	
Estimated Lifespan	403	Battery	441
Off Delay Timer	980	Drive	441
Replacement	405	microSD card	441
CoolingFan OperationTime Setting	1023	Packing material	441
Copy Function Error	330, 386	dnE	364
CP1		DO-A3	
Fault	339	Parameter	836
Minor Fault	363	Down 2 command	
CP2		Parameter	784, 788
Fault	339	Down command	
Minor Fault	363	Parameter	784, 788
CPEr	386	Down Command	870, 872
CPF00 to CPF03	339	Drive	
CPF06	339	Control Circuit Terminal Block Replacement	431
CPF07 to CPF24	339	Disposal	441
CPF25	340	Exterior Dimensions Diagram (IP20)	466, 468–476, 478–489
CPF26 to CPF45	339	Initialization	677
CPyE	386	Initialize Parameters	677
Crimp ferrule	109	Inspection	400
CrST	363	Long-Term Storage	438
CSEr	386	Rating (200 V)	446
Cumulative Operation Time Select	1023	Rating (400 V)	449
Cumulative Operation TimeSetting	1023	Drive Mode Unit Monitor Select	1011
Current Detection Speed Search	713	Drive Model Selection	1019
CyC	363	Drive watt loss	40
<b>D</b>		Droop Control	
Data log		Parameter	741
Monitor selection	184	dv1	340
Sampling time setting	184	dv2	340
Start procedure	183	dv3	340
Stop procedure	183	Detection condition settings	824
DC Injection Braking		dv4	341
Parameter	710	Detection condition settings	824
DC reactor		dv7	341
Wiring	125	dWA2	364
DCBusPreChargeRelayMainteSetting	1024	dWA3	364
Deceleration time		dWAL	364
Parameter	749	Dwell function	
Unit of measurement setting	752	Parameter	740
Delete		dWF1	341
Delete Backed-up Parameters	172	dWF2	342
Derating		dWF3	342
Altitude	464	dWFL	342
Ambient Temperature Setting	980	<b>E</b>	
Carrier Frequency	460	E5	
Change to UL Type 1	55	Fault	342
Enclosure Type	983	Minor Fault	364
External Cooling Fin	983	Operation Selection after Detection	848
Finless	983	EF	364
Side-by-side	983	EF0	
dEv		Detection conditions	841
Detection level	823	Detection conditions setting (DeviceNet)	852

Fault .....	342	Err .....	344
Minor Fault .....	364	Error Code List .....	331
Operation Selection after Detection .....	841	Exterior and mounting dimensions	
EF1		Installation dimensions .....	68
Fault .....	342	Panel cut out dimensions .....	68
Minor Fault .....	364	Exterior Dimensions Diagram (IP20)	
EF2		Drive .....	466, 468–476, 478–489
Fault .....	342	External 24 V power supply	
Minor Fault .....	365	Power supply input terminals .....	108
EF3		External Cooling Fin	
Fault .....	343	Derating .....	983
Minor Fault .....	365	<b>F</b>	
EF4		FAn	
Fault .....	343	Fault .....	344
Minor Fault .....	365	Minor Fault .....	366
EF5		FAn1 .....	344
Fault .....	343	Fast Stop Time	
Minor Fault .....	365	Parameter .....	752
EF6		Fault .....	330, 337
Fault .....	343	Fault code	
Minor Fault .....	365	MEMOBUS/Modbus .....	322
EF7		Fault Code List .....	331
Fault .....	343	Fault history	
Minor Fault .....	366	Display procedure .....	176
EF8		Fault Reset .....	388
Fault .....	344	Fault Restart	
Minor Fault .....	366	Parameter .....	967
Electrolytic Capacitor		FbH	
Estimated Lifespan .....	403	Fault .....	344
Enclosure Type		Minor Fault .....	366
Derating .....	983	FbL	
Encoder option		Fault .....	345
Parameter .....	820	Minor Fault .....	367
End1 .....	381	Feed Forward Control	
End2 .....	381	Parameter .....	997
End3 .....	381	Field Forcing	
End4 .....	381	Parameter .....	795
End5 .....	381	Field weakening	
End6 .....	381	Parameter .....	795
End7 .....	382	Fine tuning .....	204
Energy-saving control		Finless	
Parameter .....	742	Derating .....	983
Enter command .....	302	Firmware update lock .....	695
EP24v .....	366	Freq Ref Setting Method Select .....	1019
Er-01 .....	382	Freq reference bias	
Er-02 .....	382	Parameter .....	788
Er-03 .....	382	Frequency Agreement	
Er-04 .....	382	Parameter .....	965
Er-05 .....	383	Frequency reference	
Er-08 .....	383	Command source correlation diagram .....	775
Er-09 .....	383	LOCAL/REMOTE Run selection .....	775
Er-10 .....	383	Offset frequency addition .....	796
Er-11 .....	384	Switching between LOCAL/REMOTE .....	775
Er-12 .....	384	Upper and lower frequency limits .....	781
Er-13 .....	384	Frequency Reference	
Er-14 .....	384	LOCAL/REMOTE Run selection .....	697
Er-15 .....	384	Making changes using keypad .....	155
Er-16 .....	384	Switching between LOCAL/REMOTE .....	697, 706
Er-17 .....	384	Frequency reference bias	
Er-18 .....	384	Parameter .....	784
Er-19 .....	385	Frequency reference hold function	
Er-20 .....	385	Parameter .....	784, 788
Er-21 .....	385	Fuse rating .....	129
Er-25 .....	385	<b>G</b>	
ERF type braking resistor		Getting set up .....	149
Protective function .....	978	GF .....	345
Wiring .....	119		

Protective function .....	980	Installation .....	44
Ground		Installation on control panel.....	45
Drive.....	94	Language selection .....	179, 675
Ground Fault Detection		Meaning of indicators .....	141
Protective function .....	980	Method of operation.....	141
<b>H</b>		Remove .....	44
HCA.....	367	Set date and time.....	179
Alarm Settings .....	984	Set time .....	179
HD.....	445	Setup Wizard .....	181
Heavy Duty Rating.....	445	Start/stop data logging .....	183
High-Slip Braking		Keypad Display.....	1010
Parameter .....	990	Keypad Display Selection.....	1011
HOME screen.....	155	Keypad Operation .....	1017
How to read model numbers.....	21	Keypad-related settings.....	1010
Humidity		kWh Monitor Initialization.....	1025
Environment.....	35	<b>L</b>	
<b>I</b>		L24v.....	367
iFEr.....	386	Language selection .....	675
IGBT Maintenance Setting.....	1024	Procedure .....	179
Induction motor		LCD contrast adjustment.....	1013
Auto-Tuning .....	192	LED Light Function Selection.....	1021
Inertia Tuning .....	197	LED status ring	
Precautions .....	201	ALM/ERR .....	147
Input Phase Detection		Ready.....	147
Protective function .....	979	RUN.....	147
Input voltage		LF.....	345
Parameter .....	799	Protective function .....	979
Inspection		LF2 .....	346
Drive.....	400	Protective function .....	982
Installation		LKEB type braking resistor unit	
Front cover .....	50	Wiring.....	119
Keypad .....	44	Load Inertia Ratio	
Terminal cover .....	50	Parameter .....	963
UL Type 1 protective cover.....	55	LO/RE Key Function Selection .....	1017
Installation dimensions .....	68	LOCAL/REMOTE indicator.....	141, 144
Installation environment.....	35	LoG.....	368
Interlock		LSo .....	346
Circuit example .....	118	Protective function .....	986
Internal Drive Braking Transistor		LT-1 .....	368
Protective function .....	985	LT-2 .....	368
<b>J</b>		LT-3 .....	368
Jog command .....	781	LT-4 .....	368
Jog operation .....	155	<b>M</b>	
JOG operation.....	155	Main circuit terminals	
Jump frequency		Configuration of terminal block .....	76
Parameter .....	782	Line voltage drop .....	82
Jumper switch.....	112	Wire gauges .....	82
<b>K</b>		Wiring .....	76
KEB ride-thru function		Wiring procedure for terminal block.....	98
Compensation Time .....	952	Main menu	
KEB Ride-Thru function		Display procedure .....	155
Operation during momentary power loss.....	951	Maintenance Period .....	1023
KEB Ride-Thru Function		Maximum Output Frequency	
KEB Method Selection .....	954	Motor 2 Parameters.....	810
Parameter .....	945	Parameter .....	804
Single Drive KEB Method .....	954	Maximum Output Voltage	
System KEB Method.....	954	Motor 2 Parameters.....	810
Keypad		Parameter .....	805
Application Preset .....	190	MCCB .....	122
Backlight setting .....	186	Mechanical Weakening Detection	
Battery Replacement .....	437	Parameter .....	970
Data log setting .....	184	MEMOBUS	
Display drive information .....	188	Broadcast Messages .....	321
Display software version .....	188	Command data .....	303
External dimensions.....	45	Communication specifications.....	292
HOME screen .....	155	Enter command .....	302

Fault code	322
Loopback test	298
MEMOBUS/Modbus error code	325
Minor fault code	324
Monitor data	306
Register reading	297
Register writing	298
Self-diagnosis	303
Wiring	292
MEMOBUS/Modbus communications	
Serial communication terminals	108
Setting for termination resistor	116
MEMOBUS/Modbus Communications	
Parameter	927
microSD card	
Disposal	441
Insertion slot	141
Mid point B frequency	
Motor 2 parameters	811
Parameter	806
Mid point B voltage	
Motor 2 parameters	811
Parameter	806
Middle Output Frequency	
Motor 2 Parameters	810
Parameter	805
Middle Output Frequency Voltage	
Motor 2 Parameters	810
Parameter	805
Minimum output frequency	
Parameter	805
Minimum Output Frequency	
Motor 2 Parameters	810
Induction Motor	
Motor Parameters	806
Minimum Output Voltage	
Motor 2 Parameters	810
Parameter	805
Minor Fault	330, 361
Minor fault code	
MEMOBUS/Modbus	324
Minor Fault Code List	331
Modbus	
Broadcast Messages	321
Command data	303
Communication specifications	292
Enter command	302
Fault code	322
Loopback test	298
MEMOBUS/Modbus error code	325
Minor fault code	324
Monitor data	306
Register reading	297
Register writing	298
Self-diagnosis	303
Wiring	292
Molded-case circuit breaker	122
Momentary Power Loss	
KEB Compensation Time	952
Monitors	
Data log setting	184
Display analog gauge	160
Display bar graph	158
Display procedure	156
Set custom monitors	157
Show custom monitors	157
Start/stop data logging	183

Trend Plot Display	162
Motor	
Change direction of motor rotation	155
Positive Temperature Coefficient (PTC) Thermistor	939
Wiring	76
Wiring distance	94
Motor 2	
Base Frequency	810
Base voltage	811
Control mode settings	809
Leakage Inductance	813
Line-to-Line Resistance	812
Maximum Output Frequency	810
Maximum Output Voltage	810
Mid point B frequency	811
Mid point B voltage	811
Middle Output Frequency	810
Middle Output Frequency Voltage	810
Minimum Output Frequency	810
Minimum Output Voltage	810
Motor Iron Loss	813
Motor Iron-Core Saturation Coefficient 1	813
Motor Iron-Core Saturation Coefficient 2	813
Motor rated power (kW)	814
No-load Current	812
Number of motor poles	812
Rated current	811
Rated Slip	812
V/f Pattern	809
Motor Code Selection	814
Motor Overheating	
Operation During Detection of Alarms	281, 943
Operation During Detection of Faults (PTC Input)	281, 944
Motor Overload	
Electric Thermal Protection Operation Time	280, 943
Protection Functions	277, 940
Motor parameters	
Motor 2	811
Motor 2 Iron-Core Saturation Coefficient 1	813
Motor 2 number of motor poles	812
Motor 2 rated Current	811
Motor 2 rated power (kW)	814
Motor Parameters	798, 806
Motor 2 Iron Loss	813
Motor 2 Iron-Core Saturation Coefficient 2	813
Motor 2 Leakage Inductance	813
Motor 2 Line-to-Line Resistance	812
Motor 2 No-load Current	812
Motor 2 Rated Slip	812
Motor parameters (induction motors)	806
Leakage Inductance	808
Line-to-Line Resistance	807
Motor Iron Loss	808
Motor Iron-Core Saturation Coefficient 1	808
Motor Iron-Core Saturation Coefficient 2	808
Motor rated power (kW)	809
No-load Current	807
Number of motor poles	807
Rated current	276, 806
Rated Slip	807
MotorDirect@PowUpWhenUsingKeypad	1020
Multi-step speed operation	775
Setting procedure	775
<b>N</b>	
Nameplate	21
ND	445
ndAT	386

Noise filter		
Wiring	127	
Normal Duty Rating	445	
nSE	346	
NumOfRunCommands Counter Initial	1025	
<b>O</b>		
oC	347	
Overcurrent Detection Gain	982	
oFA00	348	
oFA01	348	
oFA02	348	
oFA03 to oFA06	348	
oFA10	348	
oFA11	348	
oFA12 to oFA17	349	
oFA30 to oFA43	349	
oFb00	349	
oFb01	349	
oFb02	349	
oFb03 to oFb11	349	
oFb12 to oFb17	349	
oFC00	350	
oFC01	350	
oFC02	350	
oFC03 to oFC11	350	
oFC12 to oFC17	350	
oFC50 to oFC55	350	
Off-Delay Timer	721	
Offset frequency		
Parameter	796	
oH		
Alarm Settings	978	
Fault	350	
Minor Fault	368	
oH1	351	
oH2	369	
Alarm Settings	978	
oH3		
Fault	351	
Minor Fault	369	
Operation During Detection of Alarms	281, 943	
oH4	352	
Operation During Detection of Faults (PTC Input)	281, 944	
oL1	352	
oL2	353	
Protective function	980	
oL3		
Fault	354	
Minor Fault	369	
oL4		
Fault	354	
Minor Fault	370	
oL5		
Fault	354	
Minor Fault	370	
oL7	354	
On-Delay Timer	721	
Ope Select @Keypad is Disconnect	1020	
oPE01	374	
oPE02	374	
oPE03	374	
oPE05	376	
oPE06	377	
oPE07	377	
oPE08	377	
oPE09	378	
oPE10	378	
oPE11	379	
oPE13	379	
oPE15	379	
oPE16	379	
oPE18	379	
oPE20	380	
oPE33	380	
Operation during momentary power loss		
Operation method selection	951	
Parameter	951	
Operation During Momentary Power Loss		
KEB Ride-Thru Function	945	
Speed Search function	713	
oPr	354	
Option card		
Parameter	820	
Options	490	
oS		
Detection level	823	
Detection time	823	
Fault	354	
Minor Fault	370	
Operation Select at Overspeed	821	
Output Phase Loss Detection		
Protective function	979	
ov		
Fault	355	
Minor Fault	370	
Overexcitation deceleration		
Parameter	991	
Overtorque detection		
Parameter	969	
<b>P</b>		
Panel cut out dimensions	68	
Parameter		
Access Level Selection	675	
Automatic selection	696	
Backup (drive to keypad)	169	
Changing setting values	166	
Checking modified parameters	173	
Checking user custom parameters	168	
Delete Backed-up Parameters	172	
Restore (Auto Backup)	189	
Restore (keypad to drive)	170	
Restoring default settings	174	
User-set	696	
Verify (keypad and drive)	171	
Parameter Setting Errors	330, 374	
PASS	371	
Password		
Setting	679	
Verification	679	
PC		
Connection procedure	117	
Peripheral Devices	490	
PF	356, 371	
Protective function	979	
PGo		
Detection time	824	
Fault	356	
Minor Fault	371	
Operation Selection after Detection	821	
PGoH		
Detection level	827	
Fault	356	
Level detection (PG1)	825	
Level detection (PG2)	826	

Minor Fault .....	371
Phase Order Selection .....	706
PID control .....	723
control block diagram .....	726
Feedback value input .....	725
fine tuning .....	727
Parameter .....	729
PID feedback loss detection .....	726
PID Sleep .....	727
Setpoint input .....	724
PM motor	
Auto-Tuning .....	193
PM motor parameters	
d-Axis inductance .....	815
Encoder Z pulse offset .....	816
Induced voltage constant 1 .....	816
Induced voltage constant 2 .....	816
Motor rated current .....	277, 815
Motor rated power (kW) .....	814
Number of motor poles .....	815
q-Axis inductance .....	816
Stator resistance .....	815
PM Motor Parameters .....	814
PM Motors	
Fine Adjustment .....	1001
Motor Code Selection .....	814
Motor Parameters .....	814
Positive Temperature Coefficient (PTC) Thermistor .....	939
Power loss .....	40
Protection Functions	
Drive Overheating .....	978
Motor Overload .....	277, 940
oC .....	982
oH2 .....	978
Overcurrent .....	982
Protective function	
DC bus undervoltage .....	952
Desynchronization .....	986
Drive Overheating .....	978
GF .....	980
Ground Fault Detection .....	980
HCA .....	984
Input Phase Detection .....	979
Internal Drive Braking Transistor .....	985
LF .....	979
LF2 .....	982
Low Speed Desynchronization .....	986
LSo .....	986
Motor Overheating .....	281, 943
Motor Overheating (PTC Input) .....	281, 944
oH .....	978
oH3 .....	281, 943
oH4 .....	281, 944
oL2 .....	980
Output Current Overload .....	984
Output Phase Loss Detection .....	979
Overload .....	980
PF .....	979
rr .....	985
Software Current Limit Selection .....	981
Uv1 .....	952
Pulse Train Input	
Terminal RP Function Selection .....	931
Pulse Train Input/Output	
Parameter .....	931
Pulse train output	
Terminal MP function selection .....	933

Wiring specifications .....	113
<b>R</b>	
Rating (200 V)	
Drive .....	446
Rating (400 V)	
Drive .....	449
rdEr .....	387
Ready	
LED status .....	147
Remove	
Front cover .....	50
Keypad .....	44
Terminal cover .....	50
RESET key .....	141
Residual Current Monitor/Residual Current Device	
RCM/RCD .....	122
Wiring .....	122
Restore	
Parameters (Auto Backup) .....	189
Parameters (keypad to drive) .....	170
Reverse Operation Selection .....	703
rF .....	357
rH .....	357
RJ-45 connector .....	141
Rotational Auto-Tuning	
Induction motor .....	192
PM motor .....	193
Precautions .....	200
rr .....	357
Protective function .....	985
rUn .....	371
RUN	
LED status .....	147
Run command	
LOCAL/REMOTE Run Selection .....	699
Switching between LOCAL/REMOTE .....	699
Run Command at Power Up .....	709
Run Command Selection 2	
Switching between LOCAL/REMOTE .....	708
RUN indicator .....	141, 144
RUN key .....	141
<b>S</b>	
S-curve characteristics	
Parameter .....	754
Sampling time	
Data log .....	184
SC .....	357
SCF .....	358
SE .....	371
SEr .....	358
Serial communication terminals	
MEMOBUS/Modbus communications .....	108
Set date and time	
Operation .....	179
Set time	
Operation .....	179
Setup Wizard	
Operation .....	181
Short Circuit Braking	
Parameter .....	710
Side-by-side	
Derating .....	983
Simple Positioning Stop .....	788
Slip compensation	
Parameter .....	755
Software Current Limit Selection	



Protective function .....	981	Torque compensation	
Software version		Parameter .....	791
Display procedure .....	188	Torque Compensation	
Speed Agreement		Parameter .....	759
Parameter .....	965	Torque Control	
Speed Detection		Parameter .....	790
Parameter .....	965	Switching to/from Speed Control .....	793
Speed Estimation Speed Search .....	714	Torque limit function	
Speed limit		Parameter .....	974
Parameter .....	791	Torque reference	
Speed search function		Parameter .....	791
Operation during momentary power loss .....	951	Trend Plot	
Speed Search function		Monitors .....	162
Parameter .....	713	Troubleshooting	
Stall Prevention function		Code Displayed .....	331
Parameter .....	955	No Code Displayed .....	389
Stationary Auto-Tuning		Troubleshooting without Fault Display .....	389
Induction motor .....	192	TrPC .....	372
PM motor .....	193	Tuning .....	749
Precautions .....	200	<b>U</b>	
Stationary Auto-Tuning for Line-to-Line Resistance .....	192	U2, U3 Initialization .....	1024
Precautions .....	201	UL Type 1	
Stator resistance Auto-Tuning .....	193	Attach protective cover .....	55
Precautions .....	201	UL3	
STo .....	372	Fault .....	359
SToF .....	372	Minor Fault .....	372
Stop command		UL4	
LOCAL/REMOTE Run Selection .....	699	Fault .....	359
STOP key .....	141	Minor Fault .....	372
STOP Key Function Selection .....	1018	UL5	
Stop Position Gain .....	790	Fault .....	359
Stopping Method Selection .....	699	Minor Fault .....	373
STPo .....	358	Undertorque detection	
Surge protective device		Parameter .....	969
Connection .....	126	Unit of measurement setting	
SvE .....	358	Acceleration and deceleration times .....	752
<b>T</b>		Up 2 command	
Temperature		Parameter .....	784, 788
Environment .....	35	Up command	
Terminal block .....	108	Parameter .....	784, 788
Configuration of main circuit terminal block .....	76	Up Command .....	870, 872
Control circuit terminal block functions .....	105	USB port .....	141
I/O terminals function selection switches .....	112	Connecting a PC .....	117
Terminal function selection .....	114	User Monitor Select afterPowerUp .....	1011
Terminal A1 .....	112, 114	User Parameter Default Value .....	1018
Terminal A2 .....	112, 114	User-Set Display Units Max Value .....	1013
Terminal A3 .....	112, 115	User-SetDisplayUnits Dec Display .....	1013
Terminal AM .....	112, 115	Uv .....	373
Terminal FM .....	112, 115	Speed Search Selection at Start .....	720
Termination resistor		Uv1 .....	359
Setting switch .....	116	Detection level settings .....	952
Test run		Uv2 .....	360
Checklist .....	215	Uv3 .....	360
Fine tuning .....	204	<b>V</b>	
Procedure .....	149	vAEr .....	387
Procedure for no-load test run .....	202	V/f Pattern .....	798
Procedure for test run with actual load .....	202	Second Motor .....	809
Thermal overload relay		V/f Pattern Display Unit .....	1012
Connection .....	123	Verify	
Tightening torque		Parameters (keypad and drive) .....	171
Control circuit terminals .....	109	vFyE .....	387
Main circuit terminals .....	82	Vibration-resistant .....	35
TiM		<b>W</b>	
Fault .....	359	Wire gauge	
Minor Fault .....	372	Control circuit terminals .....	109
Timer function		Wire gauges	
Parameter .....	721		

---

Main circuit terminals.....	82
Voltage drop .....	82
Wiring.....	122
AC reactor .....	125
Braking Resistor .....	119
Checklist.....	133
Control circuit terminal block.....	110
Control circuit terminals.....	104
DC reactor .....	125
Main circuit terminal block .....	98
Main circuit terminals.....	76
MEMOBUS/Modbus.....	292
Motor.....	76
Noise filter.....	127
Thermal overload relay .....	123
Wiring distance	
Drive and motor.....	94
<b>Z</b>	
Z pulse Auto-Tuning.....	193
Zero Servo function	
Parameter .....	747

## Revision History

Date of Publication	Revision Number	Section	Revised Content
October 2017	5	1, 11	Revision: Reviewed and corrected the contents.
September 2017	4	All	Revision: Reviewed and corrected entire documentation.
		2	Revision: Reviewed and corrected "Drive Watt Loss".
February 2017	3	All	Revision: Reviewed and corrected entire documentation. Upgraded drive software version to PRG: 1020. Addition: Larger drive capacities added along with corresponding data. <ul style="list-style-type: none"> <li>• Three-Phase 200 V: CIPR-GA70x2360 and 2415</li> <li>• Three-Phase 400 V: CIPR-GA70x4371 to 4675</li> </ul>
		2, 4	Addition: IP20 Applicable Gauge added to "Main Circuit Wire Gauges and Tightening Torques".
November 2016	2	All	Revision: Reviewed and corrected entire documentation. Upgraded drive software version to PRG: 1018. Addition: Larger drive capacities added along with corresponding data. <ul style="list-style-type: none"> <li>• Three-Phase 200 V: CIPR-GA70x2070 to 2313</li> <li>• Three-Phase 400 V: CIPR-GA70x4044 to 4296</li> </ul>
June 2016	1	All	Revision: Reviewed and corrected entire documentation. Upgraded drive software version to PRG: 1011.
April 2016	–	–	First Edition

# YASKAWA AC Drive GA700

## High Performance Type Technical Manual

---

### YASKAWA EUROPE GmbH

Hauptstraße 185, 65760 Eschborn, Germany  
Phone: +49-6196-569-300 Fax: +49-6196-569-398  
E-mail: [info@yaskawa.eu.com](mailto:info@yaskawa.eu.com)  
Internet: <http://www.yaskawa.eu.com>

### DRIVE CENTER (INVERTER PLANT)

2-13-1, Nishimiyaichi, Yukuhashi, Fukuoka, 824-8511, Japan  
Phone: +81-930-25-2548 Fax: +81-930-25-3431  
Internet: <http://www.yaskawa.co.jp>

### YASKAWA AMERICA, INC.

2121, Norman Drive South, Waukegan, IL 60085, U.S.A.  
Phone: +1-800-YASKAWA (927-5292) or +1-847-887-7000 Fax: +1-847-887-7310  
Internet: <http://www.yaskawa.com>

---

# YASKAWA

YASKAWA ELECTRIC CORPORATION

In the event that the end user of this product is to be the military and said product is to be employed in any weapons systems or the manufacture thereof, the export will fall under the relevant regulations as stipulated in the Foreign Exchange and Foreign Trade Regulations. Therefore, be sure to follow all procedures and submit all relevant documentation according to any and all rules, regulations and laws that may apply.

Specifications are subject to change without notice for ongoing product modifications and improvements.

© 2016 YASKAWA Electric Corporation



\*SIEPC71061705\*

MANUAL NO. SIEP C710617 05F <5>-1  
Published in Japan October 2017  
15-11-8\_YEU  
Original instructions

When performing motor auto tuning with this GA700 drive the multi-function outputs perform differently than stated in Section 3 of the Technical Manual, Precautions for Auto Tuning.

Auto Tuning Type	Mode		Digital Input	Digital Output (as described in Technical Manual)	Digital Input (actual)	Digital Output (actual)
Induction Motor Auto-Tuning	Rotational	Rotational Auto-Tuning	Disabled	Functions the same as during usual operation.	<p>Digital inputs react as in normal operation if one of the parameter setting conditions listed below becomes true:</p> <ol style="list-style-type: none"> <li>F2-01 = 1</li> <li>F3-10 to F3-25 are not set to "F" and F3-01 = 8</li> <li>H1-21 to H1-28 are not set to F</li> <li>H1-40 to H1-42 are not set to F</li> <li>H3-40 to H3-42 are not set to F</li> <li>H7-01 to H7-04 are not set to F and H7-00 = 1</li> <li>H7-30 is not set to F</li> </ol> <p>In all other case digital inputs are disabled.</p>	Functions the same as during usual operation.
	Stationary	Stationary Auto-Tuning	Disabled			
Stationary Auto-Tuning for Line-to-Line Resistance		Disabled				
PM Motor Auto-Tuning	Rotational	Z-Pulse Offset Tuning	Disabled	Functions the same as during usual operation.		<p>Digital outputs react as in normal operation if one of the parameter setting conditions listed below becomes true:</p> <ol style="list-style-type: none"> <li>H2-01 to H2-04 are not set to F</li> <li>H2-40 to H2-42 are not set to F</li> <li>H2-60/63/66/69/72 are not set to F</li> <li>H7-10/12/14/16 are not set to F and H7-00 = 1</li> <li>F5-01 to F5-08 are not set to F and F5-09 = 2</li> </ol> <p>In all other cases digital outputs keep the state that was present at the start of Auto - Tuning</p>
		PM Rotational Auto-Tuning	Disabled	Disabled		
	Stationary	PM Motor Parameter Settings	Disabled	Keeps the status at the start of Auto-Tuning.		
		PM Stationary Auto-Tuning	Disabled			
PM Stationary Auto-Tuning for Stator Resistance		Disabled				
EZ Tuning	Stationary	Motor Parameter Setting	Disabled	Keeps the status at the start of Auto-Tuning.		<p>Functions the same as during usual operation.</p>
		Stationary Auto-Tuning for Line-to-Line Resistance	Disabled			
ASR and Inertia Tuning	Rotational	Inertia Tuning	Disabled	Functions the same as during usual operation.	<p>Functions the same as during usual operation.</p>	
		ASR Tuning	Disabled			
		Deceleration Rate Tuning	Disabled			
		KEB Tuning	Disabled			

## IMPORTANT!

Before performing Auto-Tuning make sure, the actual behavior of the digital inputs/outputs as shown above does not lead to any malfunction or potentially dangerous or unsafe machine condition. In doubt disable the digital inputs/outputs or disconnect wires to digital inputs/outputs of the drive prior to performing Auto-Tuning.