

Bedienungs- und Wartungsanleitung

Drehstrommotoren mit Käfigläufer
zum Einsatz in maschinellen
Rauch- und Wärmeabzugsgeräten
nach EN 12101-3

Operating and maintenance instructions

Three-phase motors with squirrel-cage rotor
for use in powered fire and
smoke exhaust ventilators
according to EN 12101-3

Instructions de montage, d'utilisation et d'entretien

Moteurs asynchrones triphasés à cage
pour l'utilisation dans ventilateurs extracteurs
de fumées et de chaleur
selon EN 12101-3

Руководство по эксплуатации и техобслуживанию

Трёхфазные электродвигатели с короткозамкнутым ротором
для использования в механических
установках отвода дыма и тепла
согласно EN 12101-3



1. General

To operate motors in the intended way, to maintain them correctly and to prevent damage to motors and the driven equipment the procedures laid down in the Operating and Maintenance Instructions must be followed. Especially to avoid risk of injury, the separately enclosed Safety Regulations must be adhered to strictly. Since for reasons of clarity the Operating and Maintenance Instructions cannot contain specific information with regard to all conceivable special applications and areas with special requirements, the user himself has to make appropriate protection arrangements during the installation process. The motors are designed for use in powered fire gas and smoke exhaust fans according to EN 12101-3. They are double-feature motors for normal operating conditions and for trouble operation.

Normal operation: operation at normal operating conditions according to nameplate data
 Ambient temperature: -20 °C up to +40 °C
 Site above sea level: ≤1000 m
 Differing data on the nameplate must be followed strictly. The conditions at site must be in conformity with all nameplate data.

Trouble operation: A trouble case is existing, if operating conditions differ from the normal operating conditions, this is particularly valid for an incident or trouble case that is defined according to EN 12101-3 (Temperature-time classification).

After an trouble case, the motors must be replaced by new ones.

If the operating conditions, also without having a trouble case, differ from the normal operating conditions stated on the nameplate, a reduced lifetime and reduced suitability for trouble cases must be taken into account. The motors are destined for use in commercial/industrial plants. The use in potentially explosive areas is prohibited.

2. Description

The motors have been manufactured in accordance with IEC 60034-1, EN 60034-1, EN 60204-1 and other appropriate DIN standards. The details on the relevant Order Confirmation constitute the scope of supply. According to DIN EN 12101-3, the motors are classified into Classes of **F200** up to **F600**.

Fire gas temperature	Period of trouble conditions		Class according to EN 12101-3
	1 h	2 h	
200°C		●	F200
300°C	●		F300
400°C		●	F400
600°C	●		F600

In practical use, other periods of trouble conditions, deviating from DIN EN are required, too, these periods are coordinated to the basic Classes. The motors have, besides the standard type designation the following special markings:
 Special marking for sizes 63 ... 132T: BRG F... Fire gas motor, Classes F200, F300, F400

Special marking for sizes ≥ 132	Application	Class according to DIN EN 12101
FV (former FV0)	1 h at 200 °C	
FV1	2 h at 200 °C	F200
	1 h at 250 °C	
FV2	1 h at 300 °C	F300
	2 h at 250 °C	
FV3	2 h at 300 °C	
FV4-2	1 h at 400 °C	
	1,5 h at 400 °C	
	2 h at 400 °C	F400
FV4-3	2h at 400°C	F400
FV5 (on request)	1 h at 600 °C	F600
FV6 (on request)	1 h at 700 °C	

3. Degree of protection

The degree of protection of the motors is indicated on their nameplate, the degree of protection of additional devices fitted to the motor can differ from the degree of protection of the motor. This needs to be taken into consideration during the installation of the motors. If motors with cooling methods IC 411 and IC 416 are installed in the open (Protection Standard ≥ IP 44), they should be protected against direct effects of the climate (freezing of the fan due to direct fall of rain, snow and formation of ice).

4. Type of construction

The type of construction of the motors is indicated on the nameplate. The motors can be used in different types of construction only with the permission of the manufacturer and if necessary after modification carried out in accordance with the manufacturer's instructions. Especially with types of construction with vertical shaft the user has to ensure that foreign particles cannot fall into the fan cowl.

5. Transport & storage

If possible the motors should only be stored in closed and dry rooms. Outdoor storage under cover is permitted for a short time only and requires adequate protection against all harmful effects of the climate. The motors also have to be protected against mechanical damage. Never transport or store motors resting on their fan cowls. The eye bolts of the motors together with appropriate lifting tackle must be used for transport. The eye bolts are intended for the lifting of the motors only, without any additional parts such as bed plates, gears etc. If eye bolts are removed after installation, the tapped holes must be blanked off permanently according to the degree of protection.

6. Removal of the transport locking

On motors with transport safety device (roller bearing), the hexagon head screw provided for the fastening of the transport safety device is to be loosened and taken off together with the transport safety device. Subsequently the bearing cover bolt packed in a bag inside the terminal box is to be screwed into the bearing cover. If it is necessary for the motor type the bag will also contain a lock washer that is to be placed onto the bearing cover bolt before screwing it into the bearing end shield.

7. Installation and fitting

Since during normal operation of electric motors, temperatures in excess of 100 °C can occur on their surface, any contact with them must be prevented if the motors are installed in accessible areas. Because of this temperature sensitive parts must never be fitted to them or have contact with them. In types of construction IM B14 and IM B34 it must be ensured that the maximum allowed screw depth specified in the following table is not exceeded. For the flange type given in the table, the thread holes are through holes. If a motor in type of construction IM B34 is used without flange-attached components, the user has to close the through holes in an appropriate way to maintain the respective degree of protection.

Flange type acc. to DIN 42948	Flange type acc. to DIN EN 50347	Screw-in depth in mm
C80	FT65	8
C90	FT75	8
C105	FT85	8,5
C120	FT100	8,5
C140	FT115	10
C160	FT130	10
C200	FT165	12
C250	FT215	13

If a motor of type IMB34 without flanged attachments is used, the user has to take appropriate measures at the through holes to maintain the specified degree of protection.

Vent holes must be kept free and the minimum distances stated in the dimensional drawings must be maintained so that the flow of cooling air is not obstructed. Care must be taken that the discharged warmed up cooling medium is not sucked up again.

The key in the shaft end is secured by the shaft protective sleeve for transport and storage only. Because of the danger that the key may be thrown aside, a start-up or a trial run with the key protected by the shaft sleeve only is strictly forbidden.

Transmission elements (such as couplings, pinions, hubs or belt pulleys) should be drawn onto the shaft by means of pull-on devices or by heating-up the part to be drawn onto the shaft. For the purpose of drawing the transmission components onto the shaft, the shaft ends are provided with tapped centring holes according to DIN 332 Part 2. Transmission components must never be driven onto the shaft using hammer blows because the shaft, the bearings and other components of the motor could be damaged. All components that are to be fitted to the shaft end must be balanced dynamically according to the balancing system of the motor (full or half key). The rotors of the motor are balanced with half key; this is indicated by the letter H after the serial number on the nameplate. Motors with letter F after the serial number are balanced on special request with full key. If possible the motors are to be installed in such a way that they are free from vibrations. With precision balanced motors special instructions are to be followed. When the installation is completed the user must ensure protection of movable parts and safety of operation.

Direct coupling to the driven machine requires a particularly accurate alignment. The shafts of both machines must be in alignment. The shaft height is to be adjusted to that of the driven machine using appropriate shims. Belt drives put a lot of stress on the motor because of relatively high radial forces. When dimensioning belt drives, apart from the instructions and calculation programmes issued by the manufacturers of the belts, it must be ensured that the radial force permissible at the shaft end of the motor as stated in our data is never exceeded by the pull and pre-tensioning of the belt. When pre-tensioning the belt during installation the instructions of the belt manufacturers must be strictly adhered to.

8. Insulation check

When the motor is first commissioned and especially after extended storage, the insulation resistance of the winding is to be measured to earth and between phases. The test must be made with dc voltage at the design voltage level, but not lower than 500 V. During and immediately after the measurements dangerous voltages are present at the terminals. Therefore never touch the terminals and follow the operating instructions of the insulation resistance meter closely! Depending on the rated voltage U_N , the following minimum values must be maintained with a winding temperature of 25 °C:

Rated Power P_N / kW	Insulation Resistance referred to Rated Voltage / $k\Omega/V$
$1 < P_N \leq 10$	6.3
$10 < P_N \leq 100$	4
$100 < P_N$	2.5

If the minimum values are lower, the winding must be dried properly until the insulation resistance corresponds to the required value.

9. Commissioning

Please follow the Safety Regulations closely.

All work is to be carried out only when there is no voltage on the motor. The installation must be carried out according to the valid regulations by qualified skilled personnel.

Initially the mains conditions (voltage and frequency) must be compared with the data on the nameplate of the motor. The dimensions of the connecting cables must be adjusted in line with the rated currents of the motor.

The connection points of the motor are marked in accordance with DIN EN 60034-8 (DIN VDE 0530 Part 8). In Section 18 of these instructions the most common circuit diagrams for three phase motors in basic design are provided, according to which the connection will be implemented. For all other versions, the special circuit diagrams are glued to the inside of the terminal box cover or placed in the terminal box. An additional terminal box can be provided for the connection of auxiliary and protection devices (e.g. anti-condensation heaters); the same regulations apply as for the main terminal box.

Always start the motors with an over-current protection device that is set in accordance with the relevant nominal values of the motor ($\approx 1.05 I_{nom}$). Otherwise warranty claims with respect to damaged windings become void. Before the motor is connected for the first time it is recommended to check the insulation resistances between winding and earth and between phases (see Section 8). After

prolonged storage it is absolutely essential that the insulation resistance is measured. Before coupling the motor to the driven machine, check the direction of rotation of the motor to prevent possible damage being caused to the driven machine. If the mains supply with the phase sequence L1, L2 and L3 is to be wired to the connection points U, V, W, the motor is rotating clockwise looking at the shaft end. The direction of rotation can be changed by swapping the connections between 2 phases. For the permissible tightening torques for the terminal board bolts refer to the table below:

Terminal Board	Connecting Bolt Thread	Permissible Tightening Torque in Nm
16 A	M4	1.2 + 0.5
25 A	M5	2.5 ± 0.5
63 A	M6	4 ± 1
100 A	M8	7.5 ± 1.5
200 A	M10	12.5 ± 2.5
400 A	M12	20 ± 4
630 A	M16	30 ± 4

Before closing the terminal box make absolutely sure that:

- the connection has been made in accordance with the wiring diagram
- all terminal box connections are tightened
- all minimum values of air paths are maintained (larger than 8 mm up to 500 V, larger than 10 mm up to 750 V, larger than 14 mm up to 1000 V)
- the interior of the terminal box is clean and free from foreign particles
- unused cable entries are blanked off and the threaded plugs with seals are tightened
 - the seal in the terminal box cover is clean and tightly glued and all sealing surfaces are in the correct state to ensure that the relevant degree of protection is maintained.

Before starting up the motor check that all safety regulations are strictly adhered to, that the machine is correctly installed and aligned, that all fixing parts and earth connections are tightened, that the auxiliary and additional devices are functionally and correctly connected and if a second shaft end is fitted that the key is secured against being thrown aside.

If possible the motor is to be connected without load. If the motor is running smoothly and without any abnormal noise, the load of the driven machine is to be applied onto the motor. When the motor is started up it is recommended to monitor the current consumption if the motor is loaded with its driven machine so that any possible overloads and asymmetries occurring in the mains can be recognised immediately.

Please always observe the Safety Regulations during operation of the motor and when switching it off.

10. Maintenance

You are once again referred to the Safety Regulations, in particular to insulation, to securing against reconnection, to checking whether all components connected to a voltage source are in dead state.

If it is necessary to disconnect the motor from the mains for maintenance work particular care must be taken to ensure that any possibly existing auxiliary circuits (e.g. anti-condensation heaters, forced ventilators, brakes) are also disconnected from the mains.

If the motor is to be dismantled during maintenance work, the sealing compound on the centring shoulders is to be removed. When re-assembling the motor these need to be re-sealed using a suitable motor sealing compound. Existing copper sealing washer must always be refitted.

11. Draining of condensation water

On installation sites where formation of dew and thus occurrence of condensation water can be expected inside the motor, the accumulated condensation water has to be drained at regular intervals through the opening at the lowest point of the end shield. Subsequently the opening must be closed up again.

12. Motors with thermal winding protection

A continuity test of the thermistor sensor circuit using a test lamp, a hand generator and such like is strictly prohibited because this would destroy the sensors immediately. If it becomes necessary to verify the cold resistance of the sensor circuit (at approx. 20 °C) then the measuring voltage must never exceed 2.5 V DC. It is recommended to carry out the measurement using a Wheatstone bridge with a 4.5 V DC supply voltage. The cold resistance of the sensor circuit must never exceed 810 ohms; a measurement of the hot resistance is not necessary. With motors that are fitted with thermal winding protection, care must be taken that when the thermal winding protection has been tripped, and after cooling down of the motor, no hazards can occur due to spurious automatic reconnection.

When a trouble case arises, then the thermal winding protection must be disabled immediately!

13. Bearings and lubrication

13.1 General

VEM motors are equipped with antifriction bearings of well-known manufacturers. The bearings have a nominal service life of at least 20,000 hours for maximum permissible load conditions. For motors without additional axial loading, the nominal service life is 40,000 hours for direct coupling and a horizontal installation position.

The following versions are shown in the bearing arrangement tables:

Fixed bearing, Drive-end
Without fixed bearing (floating bearing)

Permanent lubrication
Relubricating device

as well as the

Antifriction bearing assignments
V-type rotary seal assignments

Disc spring and wave washer assignments
Graphical depiction of the bearing arrangements.

The respective flat grease nipples may be noted from the tables in the dimensional drawings. Motors in standard design with two deep-groove ball bearings have bearings which are set by means of disc springs or wave washers.

The most important requirement for achieving the nominal bearing service life consists of proper lubrication, i.e. use of the proper type of grease for each operational situation, use of the correct quantity of grease, and maintenance of the regreasing intervals.

Frame sizes 71 - 160 are equipped with lifetime-lubricated bearings. These bearings must be replaced promptly in accordance with the grease lifetime interval. For motors in frame size 180 and larger the bearings must be regreased promptly in accordance with the grease lifetime interval so that the nominal bearing service life can be achieved. Under normal operating conditions, the grease charge provides 10,000 service hours with two pole design and 20,000 service hours with four or more pole design without regreasing. Versions with regreasing devices provide 2.000 or 4.000 service hours respectively under normal operating conditions. Please observe chapter 13.5 for detailed information concerning the usable grease. After five regreasing operations the used grease must be removed from the grease chamber of the external bearing cover. For information on bearing sizes, type and quantity of grease and regreasing intervals please refer to the additional plate affixed to the motor.

13.2 Bearing loading and shaft end loading

Due to the international standardisation of asynchronous motors, dimensioning of the bearing arrangement and shaft is only variable within limits; a constructional optimum has thus been selected.

13.3 Admissible shaft end loading

The size of the permissible shaft end loading is determined using the following main criteria:

- permissible bending of the shaft
- shaft fatigue strength
- bearing service life

The admissible shaft end loading (radial and axial forces) is based on a bearing service life of 20,000 hours and resistance to fatigue of >2.0 .

The loading diagram is specified in the following illustration:

F_r = radial shaft end loading

F_a = axial shaft end loading

l = length of the shaft end

x = distance of the application point F_r from the shaft shoulder

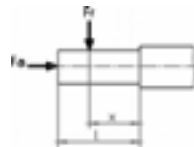

The type-related data for the permissible axial shaft end loading F_a and the permissible radial shaft end loading $F_{r0.5}$ (at the application point $x : l = 0.5$), $F_{r1.0}$ (at the application point $x : l = 1.0$) for the basic version in horizontal mounting position of the motors in the Classes F200, F300 and F400, are specified in the following tables.

The permissible radial forces are depicted as a function of the position of the application point on the shaft end for motors in horizontal mounting position of the motor .

The permissible forces given are valid for practically vibration-free mounting of the motors.

The shaft loading for frame sizes 315 L and LX and frame size 355 can be verified by the manufacturer on request.

The loadings F_r and F_a are generally dependent on the used transmission elements, fans etc., i.e. on the axial and radial forces arising from these elements, including their weights.

In practice, the radial force F_r does not always act at $x : l = 0.5$. The conversion of the permissible radial force within the range $x : l = 0.5$ up to $x : l = 1.0$ can be done by linear interpolation.

If the calculated shaft loadings exceed the permissible ones, the drive elements must be changed.

Generally, care must be taken that the resulting load application point of F_r will not be outside the shaft end. If a solution has still not been found, the manufacturer would be happy to check special constructions which can be used to deal with problems of this kind.

13.4 Bearing arrangements and their graphical depiction

13.4.1 Series K1.R, K2.R, K22R, Fire gas versions F200, F300 and F400

Horizontal type of mounting

Type	D-end						N-end			Figure		Fixed bearing							
	Antifriction bearing	V-Ring	γ-Ring	Nilos ring	Wave washer	Disc spring	Antifriction bearing	V-Ring	Wave washer	D-end	N-end								
K21R 71	6202	-	-	-	-	-	6202	-	35	1	2	none							
K21R 80	6204						6204	47											
K21R 90	6205						6205	52											
K21R 100	6206						6206	62											
K21R 100 LX																			
K21R 112 M																			
K21R 132 S2, 4 T	6208						-	-	-	-	-	6207 M C3	35A	3	5	N-end			
K11R 132 S, SX2, M6, 8	6208 RS C3											6208 Z AV	80				6308 M C3	40A	
K11R 132 M4, MX6	6308 RS C3											6308 Z AV	90				6309 M C3	45A	
K11R 160 M, MX8	6309 RS C3											6309 Z AV	100	6310 M C3	50A				
K11R 160 MX2, L	6310 RS C3	50A	-	110	-	-						6309 M C3	45A	6	8				
K11R 180 M4, L6, 8												6310 C3	6310 Z AV				110	6310 M C3	50A
K11R 180 M2, L4												6310 C3	6310 Z AV				110	6312 M C3	60A
K11R 200 L, LX6	6312 C3	60A	-	-	-	-						6312 M C3	60A						
K11R 200 LX2												6313 C3	65A				6313 M C3	65A	
K11R 225 M2												6313 C3	65A				6314 M C3	70A	
K11R 225 S4, 8, M4, 6, 8	6314 C3	70A	-	-	-	-	6314 M C3	70A	13	16									
K11R 250 M2							6316 C3	80A			6316 M C3	80A							
K11R 250 M4, 6, 8							6317 C3	80A			6317 M C3	85A							
K11R 280 S2, M2	6314 C3	70A	-	-	-	-	6314 M C3	70A	18	19									
K11R 280 S4,6,8, M4, 6, 8							6316 C3	80A			6316 M C3	80A							
K11R 315 S2, M2							6317 C3	80A			6317 M C3	85A							
K11R 315 S4, 6, 8, M4, 6, 8	6317 C3	80A	-	-	-	-	6316 M C3	80A	13	16									
K11R 315 MX2							6220 C3	RB85			180	6317 M C3	85A						
K11R 315 MX4, 6, 8							6317 C3	RB100			180	6317 M C3	85A						
K11R 315 MY2	6320 C3	-	-	-	-	-	6317 M C3	85A	18	19									
K11R 315 MY4, 6, 8							6317 C3	RB85			215	6317 M C3	85A						
K11R 315 L2, LX2							6317 C3	RB100			215	6317 M C3	85A						
K11R 315 L4, 6, 8, LX4, 6, 8	6320 C3	120S	-	-	-	-	6317 C3	85A	18	19									
K22R 355 ... 2pole	6317 C3						RB85	180			6317 M C3	85A							
K22R 355 ... 4-, 6-, 8-pole	6324 C3						120S	-			-	-	260	6317 M C3	85A				

Sizes 71 – 132 S...T: always with radial sealing rings, F200 bearing 62.. Z C3, F300/400 bearing 62.. 2Z N C4 S1

For F400 antifriction bearings N-end from 6207 up to 6317 with brass cage "M"

From size K21R 315 MX standard version with relubricating device

Series K20R/K10R

Type	D-end						N-end			Figure		Fixed bearing					
	Antifriction bearing	V-Ring	γ-Ring	Nilos-Ring	Wave washer	Disc spring	Antifriction bearing	V-Ring	Wave washer	D-end	N-end						
K20R 63	6202	-	-	-	-	-	6202	-	35	1	2	none					
K20R 71	6204						6204	47									
K20R 80	6205						6205	52									
K20R 90							6206	62									
K20R 100																	
K10R 112 M2, 4, 6, 8	6207 RS C3						50A	-	-				-	-	6207 M C3	35A	3
K10R 112 MX6, 8										6207 Z AV	72	6308 M C3			40A		
K10R 132 S, M										6308 RS C3	6208 Z AV	90			6309 M C3	45A	
K10R 160 S, M	6310 RS C3						60A	-	-	-	-	6210 Z AV	110	6	8		
K10R 180 S2, M2	6310 C3											6310 M C3	50A				
K10R 180 S4, 6, 8, M4, 6, 8	6312 C3	60A	-	-	-	-						6312 M C3	60A				
K10R 200 M2, L2							6313 C3	65A	6313 M C3	65A							
K10R 200 M4, 6, 8, L4, 6, 8							6314 C3	70A	-	-	-	-	6314 M C3			70A	
K10R 225 M2	6316 C3	80A	6316 M C3	80A													
K10R 225 M4, 6, 8	6317 C3	80A	-	-	-	-							6317 M C3	85A			
K10R 250 S2, M2							6317 C3	80A	6317 M C3	85A							
K10R 250 S4, 6, 8, M4, 6, 8							6316 C3	80A	6316 M C3	80A							
K10R 280 S2, M2	6317 C3	-	-	-	-	-	6317 M C3	85A	13	16							
K10R 280 S4,6,8, M4, 6, 8							6220 C3	RB85			180	6317 M C3	85A				
K10R 315 S2							6317 C3	RB100			180	6317 M C3	85A				
K10R 315 S4, 6, 8	6317 C3	-	-	-	-	-	6317 M C3	85A	18	19							
K10R 315 M2, L2							6317 C3	RB85			215	6317 M C3	85A				
K10R 315 M4, 6, 8, L4, 6, 8							6320 C3	RB100			215	6317 M C3	85A				

Sizes 63 – 132 S...T: always with radial sealing rings, F200 bearing 62.. Z C3, F300/400 bearing 62.. 2Z N C4 S1

For F400 antifriction bearings N-end from 6207 up to 6317 with brass cage "M"

From size K10R 315 standard version with relubricating device

13.4.2 Admissible axial and radial loads for series K21R, K11R, K22R

Fire gas version F200, F300 and F400,

Basic version horizontal shaft (figures in kN)

Size	F _a		F _{r 0,5}		F _{r 1,0}		F _a		F _{r 0,5}		F _{r 1,0}	
	Normal operation	Trouble operation	Normal operation	Trouble operation	Normal operation	Trouble operation	Normal operation	Trouble operation	Normal operation	Trouble operation	Normal operation	Trouble operation
	Synchronous speed 3000 rpm – 2pole version						Synchronous speed 1500 rpm – 4pole version					
K21R 71	0,185	0,07		0,20			0,23	0,12		0,26		
K21R 80	0,30	0,13		0,31			0,38	0,20		0,43		
K21R 90	0,305	0,13		0,36			0,42	0,20		0,46		
K21R 100	0,42	0,15	-	0,40	-	-	0,56	0,23	-	0,50	-	-
K21R 100/112	0,46	0,17		0,46			0,58	0,28		0,58		
K21R 132T	0,60	0,22		0,60			0,84	0,28		0,73		
K11R 132 S	0,60	0,40	0,92	0,60	0,82	0,52	0,84	0,53	1,16	0,73	1,03	0,65
K11R 132 SX	0,60	0,40	0,92	0,60	0,82	0,52	-	-	-	-	-	-
K11R 132 M	-	-	-	-	-	-	1,28	0,80	1,64	1,03	1,44	0,90
K11R 160 M	0,88	0,55	1,60	1,00	1,44	0,90	1,20	0,75	2,00	1,25	1,76	1,10
K11R 160 MX	1,20	0,75	1,84	1,15	1,64	1,03	-	-	-	-	-	-
K11R 160 L	1,20	0,75	1,84	1,15	1,64	1,03	1,52	0,95	2,40	1,50	2,16	1,35
K11R 180 M	1,20	0,75	1,92	1,20	1,72	1,08	1,52	0,95	2,40	1,50	2,16	1,35
K11R 180 L	-	-	-	-	-	-	2,00	1,25	2,48	1,55	2,20	1,38
K11R 200 L	1,44	0,90	2,56	1,60	2,24	1,40	1,92	1,20	3,20	2,00	2,80	1,75
K11R 200 LX	2,00	1,25	2,56	1,60	2,24	1,40	-	-	-	-	-	-
K11R 225 S	-	-	-	-	-	-	2,40	1,50	3,52	2,20	3,12	1,95
K11R 225 M	2,00	1,25	2,56	1,60	2,24	1,40	2,40	1,50	3,52	2,20	3,12	1,95
K11R 250 M	2,00	1,25	2,72	1,70	2,40	1,50	2,80	1,75	3,92	2,45	3,44	2,15
K11R 280 S	2,80	1,75	4,04	2,53	3,68	2,30	3,60	2,25	6,00	3,75	5,44	3,40
K11R 280 M	3,20	2,00	4,08	2,60	3,68	2,30	3,60	2,25	6,00	3,75	5,52	3,45
K11R 315 S	3,60	1,80	4,72	2,36	4,32	2,16	4,80	2,40	5,84	2,92	5,36	2,68
K11R 315 M	3,60	1,80	4,72	2,36	4,32	2,16	4,80	2,40	5,84	2,92	5,44	2,72
K11R 315 MX	3,60	1,80	4,80	2,40	4,48	2,24	4,00	2,00	8,00	4,00	7,52	3,76
K11R 315 MY	4,80	2,40	7,68	3,84	7,20	3,60	4,80	2,40	7,68	3,84	7,20	3,60
K11R 315L, LX	Load data on request											
K22R 355M, MX, LY, L	Load data on request											

The named data are valid for fire gas motors with horizontal shaft, for motors with vertical shaft load data on request

The loading circumstances for normal operation and for trouble operation must be checked with respect to the admissible axial loads F_a and radial loads F_r. The really acting loads must, for every operational case, not exceed the admissible ones.

13.4.3 Admissible axial and radial loads for series K10R, K20R

Fire gas version F200, F300 and F400,

Basic version horizontal shaft (figures in kN)

Size	F _a		F _{r 0,5}		F _{r 1,0}		F _a		F _{r 0,5}		F _{r 1,0}	
	Normal operation	Trouble operation	Normal operation	Trouble operation	Normal operation	Trouble operation	Normal operation	Trouble operation	Normal operation	Trouble operation	Normal operation	Trouble operation
	Synchronous speed 3000 rpm – 2pole version						Synchronous speed 1500 rpm – 4pole version					
K20R 63	0,185	0,07		0,20			0,23	0,12		0,26		
K20R 71	0,30	0,13		0,31			0,38	0,20		0,43		
K20R 80	0,305	0,13		0,36			0,42	0,20		0,46		
K20R 90	0,42	0,15		0,40			0,56	0,23		0,50		
K20R 100	0,46	0,17		0,46			0,58	0,28		0,58		
K20R 112 M	0,60	0,376	0,88	0,55	0,80	0,50	0,84	0,525	1,08	0,675	0,952	0,595
K10R 132 S	-	-	-	-	-	-	0,64	0,32	1,56	0,78	1,36	0,68
K10R 132 M	0,56	0,28	1,28	0,64	1,12	0,56	0,64	0,32	1,56	0,78	1,36	0,68
K10R 160 S	1,36	0,68	1,84	0,92	1,60	0,80	1,52	0,76	2,40	1,20	2,16	1,08
K10R 160 M	1,20	0,60	1,84	0,92	1,60	0,80	1,52	0,76	2,40	1,20	2,16	1,08
K10R 180 S	1,36	0,68	1,84	0,92	1,60	0,80	1,92	0,96	3,28	1,64	2,88	1,44
K10R 180 M	1,36	0,68	1,84	0,92	1,60	0,80	1,92	0,96	3,28	1,64	2,88	1,44
K10R 200 M	1,92	0,96	2,56	1,28	2,24	1,12	2,40	1,20	3,52	1,76	3,12	1,56
K10R 200 L	1,92	0,96	2,56	1,28	2,24	1,12	2,40	1,20	3,52	1,76	3,12	1,56
K10R 225 M	1,52	0,76	2,00	1,00	1,76	0,88	2,80	1,40	4,08	2,04	3,60	1,80
K10R 250 S	2,80	1,40	4,04	2,02	3,68	1,84	3,60	1,80	6,00	3,00	5,44	2,72
K10R 250 M	3,20	1,60	4,08	2,04	3,68	1,84	3,60	1,80	6,00	3,00	5,52	2,76
K10R 280 S	3,60	1,80	4,72	2,36	4,32	2,16	4,80	2,40	5,84	2,92	5,36	2,68
K10R 280 M	3,60	1,80	4,72	2,36	4,32	2,16	4,80	2,40	5,84	2,92	5,44	2,72
K10R 315 S	3,60	1,80	4,80	2,40	4,48	2,24	4,00	2,00	8,00	4,00	7,52	3,76
K10R 315 M	4,80	2,40	7,68	3,84	7,20	3,60	4,80	2,40	7,68	3,84	7,20	3,60
K10R 315 L	Load data on request											

The named data are valid for fire gas motors with horizontal shaft, for motors with vertical shaft load data on request

The loading circumstances for normal operation and for trouble operation must be checked with respect to the admissible axial loads F_a and radial loads F_r. The really acting loads must, for every operational case, not exceed the admissible ones.

13.4.4 Series Y210, Y220, Y200, Fire gas versions F200, F300 and F400

Types of mounting IM B5, IM V1, IM V3, IM B35, IM V15, IM V36, degree of protection IP 55

Type	Shaft end d x l in mm	D-end	Bearings		
			Standard	N-end Inverter feeding	
Synchronous speed 1500 rpm – 4pole version					
Y210 280 S4	Y200 250 S4	70x140	2 x 7316B MB UA	6316 M C3	6314 M C3 VL0241
Y210 280 M4	Y200 250 M4	70x140	2 x 7316B MB UA	6316 M C3	6314 M C3 VL0241
Y210 315 S4	Y200 280 S4	80x140	2 x 7317B MB UA	6316 M C3	6316 M C3 VL0241
Y210 315 M4	Y200 280 M4	80x140	2 x 7317B MB UA	6316 M C3	6316 M C3 VL0241
Y210 315 MX4	Y200 315 S4	80x140	2 x 7317B MB UA	6316 M C3	6316 M C3 VL0241
Y210 315 MY4	Y200 315 M4	80x140	2 x 7320B MB UA	6317 M C3	6317 M C3 VL0241
Y210 315 L4	Y200 315 L4	80x140	2 x 7320B MB UA	6317 M C3	6317 M C3 VL0241
Y210 315 LX4	Y200 315 LX4	80x140	2 x 7320B MB UA	6317 M C3	6317 M C3 VL0241
Y220 355 MX4		100x210	2 x 7324B MB UA	6317 M C3	6317 M C3 VL0241
Y220 355 LY4		100x210	2 x 7324B MB UA	6317 M C3	6317 M C3 VL0241
Synchronous speed 1000 rpm – 6pole version					
Y210 280 S6	Y200 250 S6	70x140	2 x 7316B MB UA	6314 M C3	6314 M C3 VL0241
Y210 280 M6	Y200 250 M6	70x140	2 x 7316B MB UA	6314 M C3	6314 M C3 VL0241
Y210 315 S6	Y200 280 S6	80x140	2 x 7317B MB UA	6316 M C3	6316 M C3 VL0241
Y210 315 M6	Y200 280 M6	80x140	2 x 7317B MB UA	6316 M C3	6316 M C3 VL0241
Y210 315 MX6	Y200 315 S6	80x140	2 x 7317B MB UA	6316 M C3	6316 M C3 VL0241
Y210 315 MY6	Y200 315 M6	80x140	2 x 7320B MB UA	6317 M C3	6317 M C3 VL0241
Y210 315 L6	Y200 315 L6	80x140	2 x 7320B MB UA	6317 M C3	6317 M C3 VL0241
Y210 315 LX6	Y200 315 LX6	80x140	2 x 7320B MB UA	6317 M C3	6317 M C3 VL0241
Y220 355 M6		100x210	2 x 7324B MB UA	6317 M C3	6317 M C3 VL0241
Y220 355 MX6		100x210	2 x 7324B MB UA	6317 M C3	6317 M C3 VL0241
Synchronous speed 750 rpm – 8pole version					
Y210 315 S8	Y200 280 S8	80x140	2 x 7317B MB UA	6316 M C3	6316 M C3 VL0241
Y210 315 M8	Y200 280 M8	80x140	2 x 7317B MB UA	6316 M C3	6316 M C3 VL0241
Y210 315 MX8	Y200 315 S8	80x140	2 x 7317B MB UA	6316 M C3	6316 M C3 VL0241
Y210 315 MY8	Y200 315 M8	80x140	2 x 7320B MB UA	6317 M C3	6317 M C3 VL0241
Y210 315 L8	Y200 315 L8	80x140	2 x 7320B MB UA	6317 M C3	6317 M C3 VL0241
Y210 315 LX8	Y200 315 LX8	80x140	2 x 7320B MB UA	6317 M C3	6317 M C3 VL0241
Y220 355 M8		100x210	2 x 7324B MB UA	6317 M C3	6317 M C3 VL0241
Y220 355 MX8		100x210	2 x 7324B MB UA	6317 M C3	6317 M C3 VL0241
Y220 355 LY8		100x210	2 x 7324B MB UA	6317 M C3	6317 M C3 VL0241

13.4.5 Admissible axial and radial loads for series Y210, Y220, Y200

Fire gas version F400

Basic version for horizontal and vertical shafts (Figures in N)

Motor type	Admissible load, horizontal type of mounting		Admissible load, vertical type of mounting		
	axial	radial	axial	radial	
Synchronous speed 1500 rpm – 4pole version					
Y210 280 S4	Y200 250 S4	1450	3800	5250	390
Y210 280 M4	Y200 250 M4	1600	3800	5400	390
Y210 315 S4	Y200 280 S4	1480	5600	7080	570
Y210 315 M4	Y200 280 M4	2500	5600	8100	570
Y210 315 MX4	Y200 315 S4	3000	5600	8600	570
Y210 315 MY4	Y200 315 M4	3400	5600	9000	570
Y210 315 L4	Y200 315 L4	4000	5600	9600	570
Y210 315 LX4	Y200 315 LX4	4000	5600	9600	570
Y220 355 MX4		5000	5600	10600	570
Y220 355 LY4		5500	5600	11100	570
Synchronous speed 1000 rpm – 6pole version					
Y210 280 S6	Y200 250 S6	800	3800	4600	280
Y210 280 M6	Y200 250 M6	1050	3800	4850	280
Y210 315 S6	Y200 280 S6	1200	5600	6800	410
Y210 315 M6	Y200 280 M6	2000	5400	7400	390
Y210 315 MX6	Y200 315 S6	2850	7900	10750	570
Y210 315 MY6	Y200 315 M6	3500	7900	11400	570
Y210 315 L6	Y200 315 L6	3650	7900	11550	570
Y210 315 LX6	Y200 315 LX6	3800	7900	11700	570
Y220 355 M6		4800	7900	12700	570
Y220 355 MX6		5350	7900	13250	570
Synchronous speed 750 rpm – 8pole version					
Y210 315 S8	Y200 280 S8	1900	5700	7600	290
Y210 315 M8	Y200 280 M8	2050	7900	9950	400
Y210 315 MX8	Y200 315 S8	2200	7900	10100	400
Y210 315 MY8	Y200 315 M8	2400	7900	10300	400
Y210 315 L8	Y200 315 L8	2500	7900	10400	400
Y210 315 LX8	Y200 315 LX8	3300	7900	11200	400
Y220 355 M8		3650	7900	11550	400
Y220 355 MX8		3800	7900	11700	400
Y220 355 LY8		4400	5700	10100	290

13.5.4 Graphic depiction to the bearing arrangements

In the following figures, the versions of the different bearing arrangement are shown in detail.

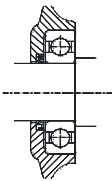
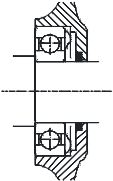
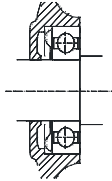
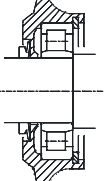
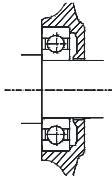
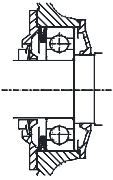
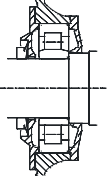
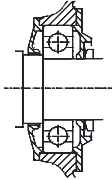
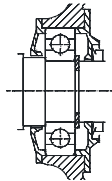
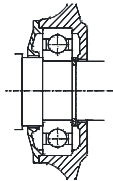
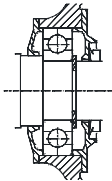
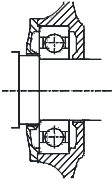
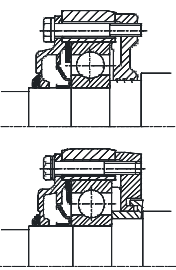
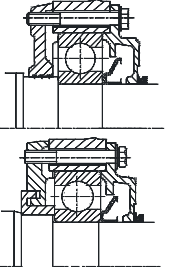
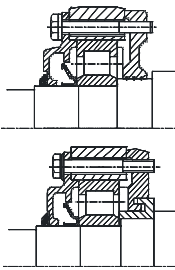
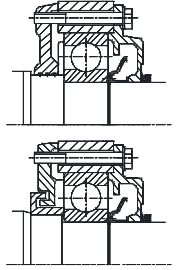
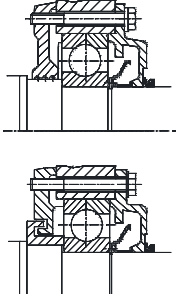
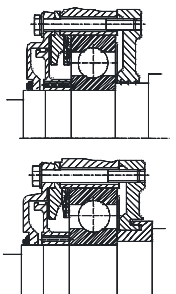
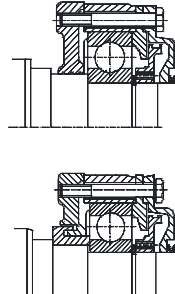
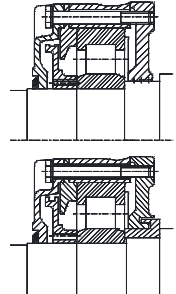
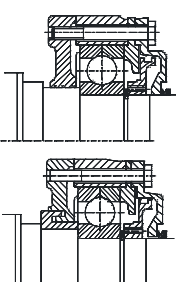
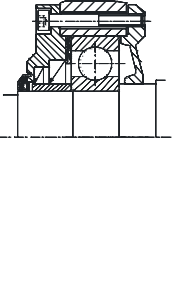
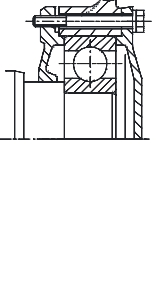
			
figure 1	figure 2	figure 3	figure 4
			
figure 5	figure 6	figure 7	figure 8
			
figure 9	figure 10	figure 11	figure 12
			
figure 13	figure 14	figure 15	figure 16
			
figure 17	figure 18	figure 19	figure 20
			
figure 21	figure 22	figure 23	figure 24

13.5. Greasing, regreasing periods and required grease amounts

The antifriction bearings of the motors in standard design are filled with antifriction bearing grease in the factory (or with sealed bearings by the bearing manufacturer) according to DIN 51825 in compliance with the table below:

Type Series	Lubricating Grease acc. to DIN 51825	Basic grease
Squirrel-cage motors FV, FV1 and FV2	KE2/3R-40 (Standard grease)	Ester oil/polyurea
Squirrel-cage motors K11R, K11O 132 – 315, K21R71-132..T, K22R 355 and K10R, K10O 112 – 315, FV3	KHC1R-30	Synth. Hydrocarbon/organic polymer
Squirrel-cage motors K11R, K11O 132 – 315, K22R 355 and K10R, K10O 112 – 315, FV4, FV4-2, FV4-3, FV5	KPFK2U-40	PFPE / Sodium complex

Under normal load and climatic conditions, the quality of grease guarantees operation of the motor for approx. 10,000 service hours with two pole design and 20,000 service hours with multi-pole design. Unless otherwise agreed the antifriction bearing grease does not have to be refilled during this period. However, the condition of the grease should be checked occasionally even before this time limit. The indicated number of service hours is only valid for operation at rated speed. If during operation of the motor via a frequency converter the nominal speed is exceeded then the regreasing period is reduced approximately in inverse proportion to the increase in the motor speed.

Regrease the bearings only after a thorough cleaning using suitable solvents. The same type of grease must be used. When replacing the grease only the equivalent types specified by the motor manufacturer can be used. Please bear in mind that the bearings should only be filled up to about 2/3 of their free space. A complete filling of the bearings and bearing covers with grease leads to increased bearing temperature and therefore to increased wear.

The regreasing of bearings with a relubricating facility is carried out at the grease nipple when the motor is running using the grease quantity and regreasing intervals required for the respective motor.

The used grease is collected in the grease chamber of the external bearing cover. After approx. five regreasings this old grease should be removed, e.g. as part of inspection work.

When the machine is commissioned after a longer period of storage inspect the bearing grease visually and replace it if hardening and other irregularities occur. If the motors are to be commissioned more than three years after their delivery by the manufacturer then the bearing grease must always be replaced. With motors fitted with covered or sealed bearings after a storage period of four years the bearings must always be replaced with new bearings of the same type.

Series K11R, K11O, K10R, K10O, K22R, K22O

Series K10., K22. Size	Design length / Pole number	Grease amount in cm ³	
		D-end	N-end
112	all	10	10
132		17	17
160			20
180	2	23	23
	≥ 4		
200	2	31	31
	≥ 4		
225	2	35	
	≥ 4		35
250	2	41	
	≥ 4		41
280	2	52	
	≥ 4		52
315	S2	57	
	M2		57
	S4, 6, 8	64	52
355	M4, 6, 8	78	
	2	57	57
	4, 6, 8	90	

Series K11. Size	Design length / Pole number	Grease amount in cm ³	
		D-end	N-end
160	LX2, M2, L4, 6, 8		20
180	M2, L4	23	23
	M4, L6, 8		20
200	L2	-	-
	LX2		31
225	L4, 6, 8, LX 6	31	23
	M2		
250	M4, 6, 8, S4, 8		31
	M2	35	
280	M4, 6, 8		35
	2	41	
315	≥ 4		41
	2	52	
	≥ 4		52
	MX2	57	
	MY2		57
	MX4, 6, 8	64	52
	MY4, 6, 8	78	57

14. Cleaning

So that the effects of cooling air are not interfered with, all parts of the motor must be cleaned at regular intervals. In the majority of cases it is sufficient to clean the machine with compressed air that is free from water and oil. Especially the vent holes and the spaces between the fins must be kept clean. It is recommended to include the electric motors in the regular routine inspections of the driven machine.

15. Warranty, Repair, Spare Parts

Unless expressly agreed otherwise our authorised workshops are responsible for all repairs under warranty. Any other repairs that may potentially be required can also be carried out by skilled personnel in these workshops. Details about our Customer Service network can be obtained from the manufacturer on request. Spare parts are listed in Section 19 of these Operating and Maintenance Instructions. Maintenance carried out appropriately (provided it is as described in the Section "Maintenance") does not constitute a breach of warranty provisions. The contractual warranty liability on the part of the manufacturer is not prejudiced by this.

16. Electromagnetic Compatibility

The motors, as a non-independently working unit, have been checked with regard to their conformity with the EMC Standards. It is the responsibility of the equipment operator to ensure by suitable measures that the equipment and systems in their entirety comply with the relevant electromagnetic compatibility standards.

17. Trouble Shooting

General mechanical and electrical faults are to be rectified according to the diagram in Section 20. All Safety Regulations must be strictly observed when rectifying faults.

18. Terminal board circuits

Single Speed Squirrel Cage Motor:

Δ low voltage

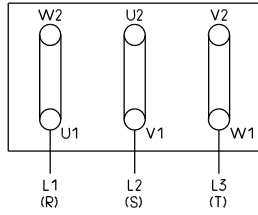

Single Speed Squirrel Cage Motor:

Y high voltage

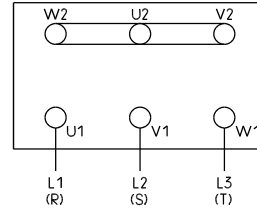

Star Delta Switch Connection:

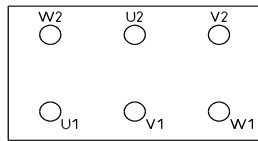

For Star Delta without bridges, connection as per the switch diagram

Motors with Thermal Winding Protection

Terminal board connection as above

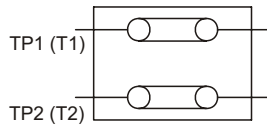

Connection of the tripping device from the motor

The connection is implemented as per the connection diagram of the tripping device

19. Construction of the motor

Item No.	Bezeichnung	Designation
1.01	Lagerschild D-Seite	End shield Drive-end
1.02	Lagerdeckel, D-Seite, außen	Bearing cover, Drive-end, external
1.03	Lagerdeckel, D-Seite, innen	Bearing cover, Drive-end, internal
1.04	Tellerfeder / Wellfeder, D-Seite, nicht bei Rollenlagern	Disc spring / wave washer, Drive-end, not for roller bearings
1.05	Wälzlager D-Seite	Antifriction bearing, Drive-end
1.06-1	V-Ring D-Seite	V-type rotary seal, Drive-end
1.06-2	γ -Ring D-Seite	γ -type rotary seal, Drive-end
1.07	Flanschlagerschild	Flange end shield
1.08-1	Radial-Wellendichtring 1, D-Seite	Radial sealing ring 1, Drive-end
1.08-2	Radial-Wellendichtring 2, D-Seite	Radial sealing ring 2, Drive-end
1.09	Laufbuchse, D-Seite	Liner, Drive-end
2.01	Lagerschild N-Seite	End shield Non-drive end
2.02	Lagerdeckel, N-Seite, außen	Bearing cover, Non-drive end, external
2.03	Lagerdeckel, N-Seite, innen	Bearing cover, Non-drive end, internal
2.04	Wälzlager N-Seite	Antifriction bearing, Non-drive end
2.05	V-Ring N-Seite	V-type rotary seal, Non-drive end
2.06	Wellfeder N-Seite (oder D-Seite)	Wave washer, Non-drive end (or Drive-end)
3.01	1 Paar Motorfüße	1 pair of motor feet
3.02	Lüfter	Fan
3.03	Lüfterhaube, Kunststoff	Fan cowl, plastic
3.04	Lüfterhaube, Stahlblech	Fan cowl, sheet steel
3.05	Lüfterhaube mit Schutzdach	Fan cowl with canopy
3.06	Ringschraube	Lifting eye bolt
4.01/4.02	Klemmenkastendeckel	Terminal box cover
4.03/4.04	Dichtung Klemmenkastendeckel	Terminal box cover gasket
4.05/4.06	Klemmenkastenunterteil	Terminal box base
4.07	Dichtung Klemmenkastenunterteil	Terminal box base gasket
4.08	Klemmenplatte	Terminal plate
4.09	Kabeleinführung	Cable gland
4.10	Verschlussschraube	Screw plug for gland opening
4.11	Kabeleinführung für thermischen Wicklungsschutz	Cable gland for thermal winding protection
4.12	Anschluß für therm. Wicklungsschutz	Terminal for thermal winding protection
4.13	Schelle	Clamp
4.14	Verschlussstücken	Sealing components
4.15	Zwischenplatte	Adapter plate
4.16	Flacher Anschlußkasten	Flat terminal box
4.17	Normalienbeutel	Standard parts bag
5.01	Läufer, komplett	Rotor, complete
6.01	Schleuderscheibe, D-Seite	Grease thrower ring, Drive-end
6.02	Schleuderscheibe, N-Seite	Grease thrower ring, Non-drive end
6.03	Labyrinthbuchse, D- u. N-Seite	Labyrinth gland, Drive- and Non-drive end
6.04	Leitscheibe, D-Seite	Guide disc, Drive-end
6.05	Leitscheibe, N-Seite	Guide disc, Non-drive end

Three-phase asynchronous motor / Basic version K1.R/K22R 112 – 355
(Example, delivered version may differ in details)

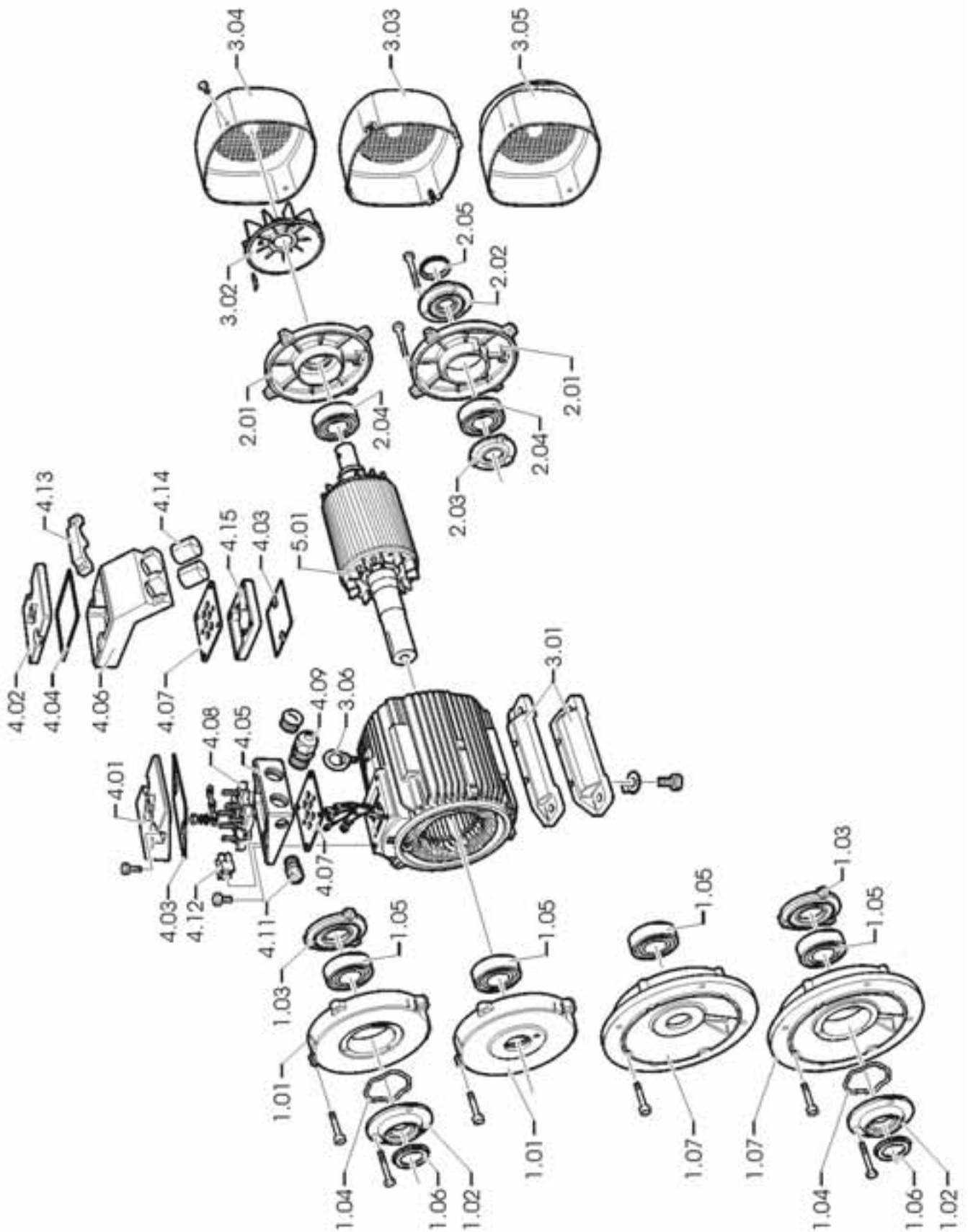

Non-ventilated three-phase asynchronous motor / Basic version K1.O/K22O 112 – 355
 (example, delivered version may differ in details)

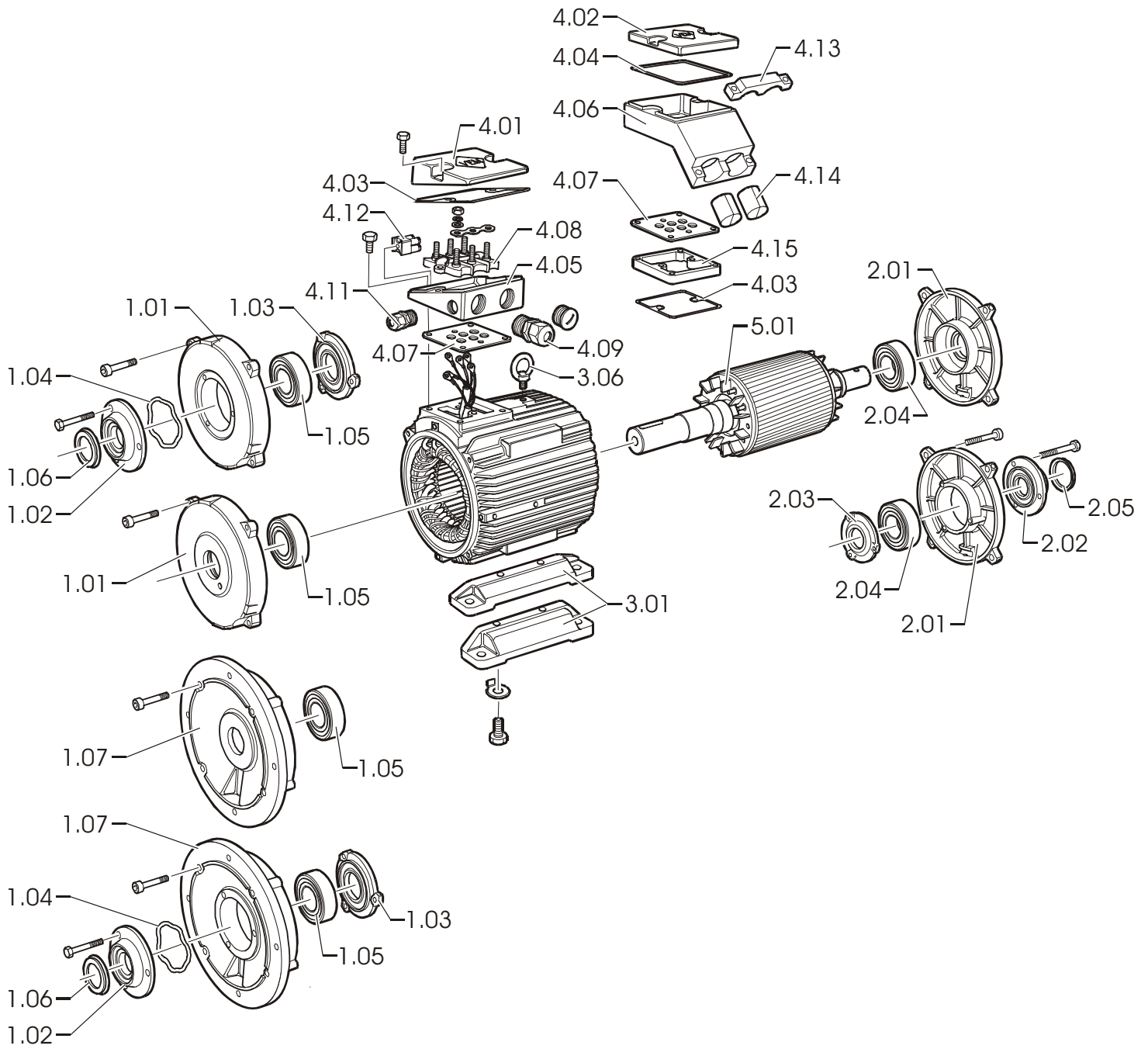

Three-phase motors of the series Y..O have, except the terminal box location at the N-end, the same design

20. Trouble Shooting

20.1 Electrical Faults

	Motor doesn't start	
	Motor runs up heavily	
	Humming noise during start	
	Humming noise during operation	
	Hum in time of the double slip frequency	
	Excessive heating up in no-load operation	
	Excessive heating up at rated output	
	Excessive heating up of individual winding sections	
	Possible cause of fault	Remedial measure
● ● ●	Overload	Decrease the load
●	Interruption of a phase in the supply conductor	Check the switch and the supply conductor
● ● ●	Interruption of a phase in the supply conductor after switching-on	Check the switch and the supply conductor
●	Mains voltage too low, frequency too high	Check the mains conditions
●	Mains voltage too high, frequency too low	Check the mains conditions
● ● ● ●	Stator winding misconnected	Check the winding conditions
● ● ●	Turn-to-turn fault	Check the winding and the insulation resistance, repair in authorised service workshop
● ● ●	Phase-to-phase short circuit	Check the winding and the insulation resistance, repair in authorised service workshop
●	Interruption in the squirrel cage winding	Repair in authorised service workshop

20.2 Mechanical Faults

					Dragging noise
					Excessive heating up
					Strong vibrations
					Bearing heats up excessively
					Bearing noises
					Possible cause of fault
					Remedial measure
●	●	●			Rotary parts are dragging
					Determine the cause, re-align parts
				●	Air supply reduced
					Check the ventilation passages
				●	Unbalance of the rotor
					Take rotor off, re-balance it
				●	Rotor not circular, shaft deformed
					Take rotor off, co-ordinate further measures with the manufacturer
				●	Imperfect alignment
					Align motor & driven machine, check the coupling
				●	Unbalance of the coupled machine
					Re-balance coupled machine
				●	Shocks from the coupled machine
					Check the coupled machine
				●	Irregularities from the gear
					Check and repair the gear
				●	Resonance with the foundation
					Stiffen the foundation after consultation
				●	Changes in the foundation
					Determine the cause, eliminate it and re-align the machine
				●	Too much grease in the bearing
					Remove excess grease
				●	Coolant temperature over 40 °C
					Regrease bearing with suitable grease
				●	V-type rotary seal or gamma ring is dragging
					Replace V-type rotary seal or gamma ring, maintain the prescribed installation clearance
				● ●	Lubrication insufficient
					Lubricate according to instructions
				● ●	Bearing is corroded
					Replace bearing
				● ●	Bearing clearance too small
					Use bearing with larger bearing clearance
				●	Bearing clearance too large
					Use bearing with smaller bearing clearance
				●	Chatter marks in the bearing track
					Replace bearing
				●	Standstill marks
					Replace bearing
				●	Cylindrical roller bearing operated at low load
					Change the bearing according to manufacturer's instructions
				●	Coupling pushes or pulls
					Re-align motor & driven machine
				●	Belt tension too high
					Adjust the belt tension according to instructions
				● ●	Bearing not aligned or stressed
					Check the bearing bore, consult the manufacturer

Note:

We make all efforts to better our products continuously.

Versions, technical data and figures could be changed therefore.

They are always not binding before written confirmation by the supply factory.



VEM motors GmbH

Carl-Friedrich-Gauß-Straße 1
D-38855 Wernigerode
Telefon: +49 - (0) 39 43 - 68 - 0
Telefax: +49 - (0) 39 43 - 68 - 21 20

E-Mail: motors@vem-group.com
Internet: www.vem-group.com

VEM motors Thurm GmbH

Äußere Dresdner Straße 35
D-08066 Zwickau
Telefon: +49 - (0) 375 - 427 - 0
Telefax: +49 - (0) 375 - 427 - 383

E-Mail: motorsthurm@vem-group.com
Internet: www.vem-group.com

mit uns bewegt sich was

